

# **FURUNO**

## **OPERATOR'S MANUAL**

*SSB RADIOTELEPHONE*

**FS-1575**

**FS-2575**

Model

---

**FS-5075**

**ECF**

(Elemental Chlorine Free)

The paper used in this manual  
is elemental chlorine free.

**FURUNO ELECTRIC CO., LTD.**

9-52 Ashihara-cho,  
Nishinomiya, 662-8580, JAPAN

• FURUNO Authorized Distributor/Dealer

All rights reserved. Printed in Japan

Pub. No. OME-56770-J5

(ETMI ) FS-1575/2575/5075

A : JUL. 2011

J5 : DEC. 22, 2017



0 0 0 1 7 5 1 6 5 1 8

# IMPORTANT NOTICES

---

## General

- This manual has been authored with simplified grammar, to meet the needs of international users.
- The operator of this equipment must read and follow the descriptions in this manual. Wrong operation or maintenance can cancel the warranty or cause injury.
- Do not copy any part of this manual without written permission from FURUNO.
- If this manual is lost or worn, contact your dealer about replacement.
- The contents of this manual and equipment specifications can change without notice.
- The example screens (or illustrations) shown in this manual can be different from the screens you see on your display. The screens you see depend on your system configuration and equipment settings.
- Save this manual for future reference.
- Any modification of the equipment (including software) by persons not authorized by FURUNO will cancel the warranty.
- The following concern acts as our importer in Europe, as defined in DECISION No 768/2008/EC.
  - Name: FURUNO EUROPE B.V.
  - Address: Ridderhaven 19B, 2984 BT Ridderkerk, The Netherlands
- All brand and product names are trademarks, registered trademarks or service marks of their respective holders.

## How to discard this product

Discard this product according to local regulations for the disposal of industrial waste. For disposal in the USA, see the homepage of the Electronics Industries Alliance (<http://www.eiae.org/>) for the correct method of disposal.

## How to discard a used battery

Some FURUNO products have a battery(ies). To see if your product has a battery, see the chapter on Maintenance. Follow the instructions below if a battery is used. Tape the + and - terminals of battery before disposal to prevent fire, heat generation caused by short circuit.

### In the European Union

The crossed-out trash can symbol indicates that all types of batteries must not be discarded in standard trash, or at a trash site. Take the used batteries to a battery collection site according to your national legislation and the Batteries Directive 2006/66/EU.

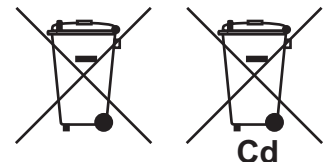

### In the USA

The Mobius loop symbol (three chasing arrows) indicates that Ni-Cd and lead-acid rechargeable batteries must be recycled. Take the used batteries to a battery collection site according to local laws.

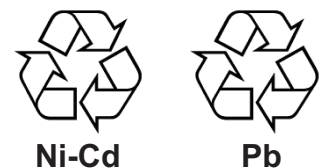

### In the other countries

There are no international standards for the battery recycle symbol. The number of symbols can increase when the other countries make their own recycle symbols in the future.



# SAFETY INSTRUCTIONS

The user and installer must read the appropriate safety instructions before attempting to install or operate the equipment.



## DANGER

Indicates a condition that will result in death or serious injury if not avoided.



## WARNING

Indicates a condition that can cause death or serious injury if not avoided.



## CAUTION

Indicates a condition that can cause minor or moderate injury if not avoided.



Warning, Caution



Prohibitive Action



Mandatory Action



## DANGER

**Never touch the SSB antenna, antenna coupler or lead-in insulator when the SSB radiotelephone is transmitting.**

High voltage which will cause death or serious injury is present at the locations shown in the illustration below when the SSB radiotelephone is transmitting.

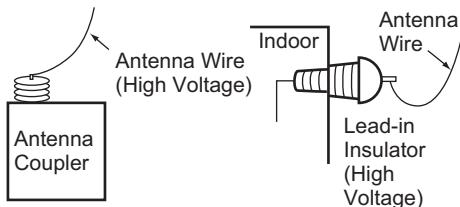

## WARNING



**Immediately turn off the power at the switchboard if the equipment is emitting smoke or fire.**

Continued use of the equipment can cause fire or electrical shock. Contact a FURUNO agent for service.



**Do not place liquid-filled containers on the top of the equipment.**

Fire or electrical shock can result if a liquid spills into the equipment.



**Do not operate the equipment with wet hands.**

Electrical shock can result.



**Turn off the power immediately if you feel the equipment is behaving abnormally.**

Turn off the power at the switchboard if the equipment becomes abnormally warm or is emitting odd noises. Contact a FURUNO dealer or agent for advice.



**Make sure no rain or water splash leaks into the equipment.**

Fire or electrical shock can result if water leaks in the equipment.



**Use the proper fuse.**

Use of the wrong fuse can cause fire or electrical shock.



## WARNING



**Do not open the equipment.**

Only qualified personnel should work inside the equipment.





**Immediately turn off the power at the switchboard if water leaks into the equipment or something is dropped into the equipment.**



Continued use of the equipment can cause fire or electrical shock. Contact a FURUNO agent for service.



**Do not disassemble or modify the equipment.**

Fire, electrical shock or serious injury can result.

 <b>WARNING</b>	
	<p><b>Do not operate the [DISTRESS] key except in case of a life-endangering situation on your vessel.</b></p> <p>Operating the [DISTRESS] key transmits the distress alert. Accidental transmission may prevent search and rescue operations for actual emergency. If the distress alert is accidentally transmitted, contact the nearest station to cancel the alert.</p>

 <b>CAUTION</b>	
	<p>If the distress alert is accidentally transmitted, contact the nearest coast station and inform them of the accidental transmission, providing the following data:</p> <p>a) Ship's name b) Ship's call sign and DSC number c) Position at time of transmission d) Time of transmission</p>
	<p><b>Do not apply strong pressure to the LCD, which is made of glass.</b></p> <p>Injury can result if the LCD breaks.</p>

### WARNING LABELS

Warning labels are attached to the equipment. Do not remove any label. If a label is missing or damaged, contact a FURUNO agent or dealer about replacement.

 <b>WARNING</b> 
<p>To avoid electrical shock, do not remove cover. No user-serviceable parts inside.</p>
 <b>警告</b> 
<p>感電の恐れあり。 サービスマン以外の方はカバーを開けないで下さい。内部には高電圧部分が多い数多くあり、万ざさわると危険です。</p>

Name: Warning Label 1  
Type: 86-003-1011-3  
Code No.: 100-236-233-10

	 <b>DANGER</b>
	<p>Electrical shock hazard. Do not touch parts inside this cover.</p>
	 <b>危険</b>
	<p>感電の恐れあり。 カバーの内部には、絶対に触れないで下さい。</p>

Name: Warning Label  
Type: 14-055-4202-1  
Code No.: 100-245-221-10



Name: High Temp Warning Label  
Type: 05-089-2142-0  
Code No.: 100-301-620-10

### — About the TFT LCD —

The TFT LCD is constructed using the latest LCD techniques, and displays 99.99% of its pixels. The remaining 0.01% of the pixels may drop out or blink, however this is not an indication of malfunction.

# DISTRESS ALERT

## How to send distress alert

Below is the procedure for transmitting a distress alert via radiotelephone. Transmit the distress alert when a life-endangering situation occurs on your vessel.

1. Open the **DISTRESS** key cover then press the **DISTRESS** key until the alarm beeps and the ALARM lamp flashes.

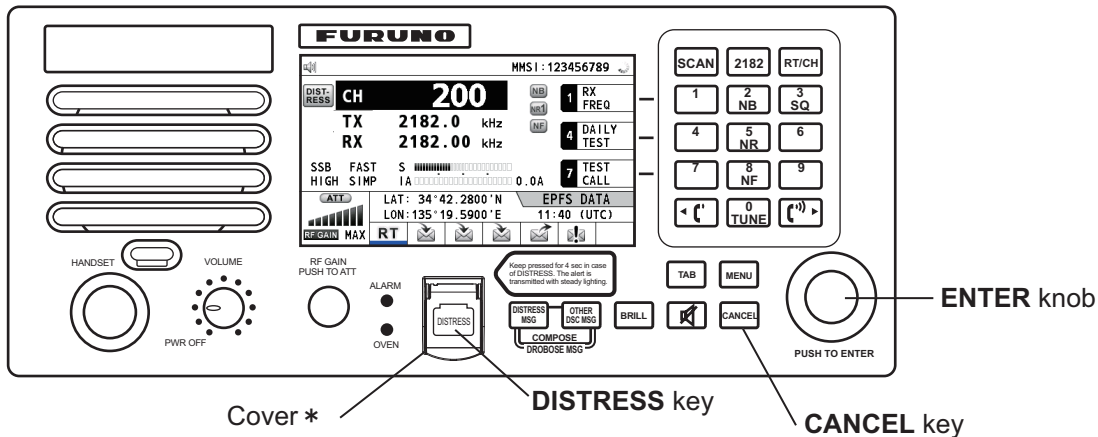

\*: The **DISTRESS** key is covered to prevent accidental operation.

While pressing the key, the following screen appears.

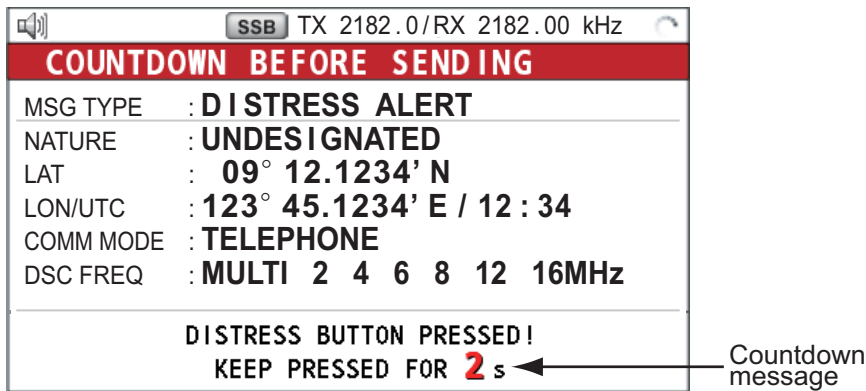

2. When the message "Sending DISTRESS ALERT." appears on the screen, release the **DISTRESS** key. The audio alarm sounds for two seconds.

After the distress alert has been sent, the following screens appear in order.

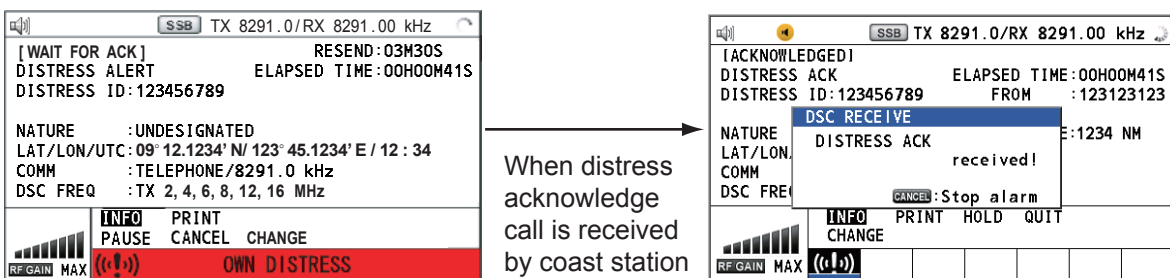

3. The audio alarm sounds. Press the **CANCEL** key to silence the audio alarm.

4. Communicate with the coast station via radiotelephone as below.
  - a) Say "MAYDAY" three times.
  - b) Say "This is..." name of your ship and call sign three times.
  - c) Give nature of distress and assistance needed.
  - d) Give description of your ship (type, color, number of persons on board, etc.).

**Note:** If you do not receive the distress alert acknowledge call, the equipment automatically re-transmits the distress alert after 3 min 30 seconds to 4 min 30 seconds. Then awaits the distress alert acknowledge call. This is repeated until the distress alert is acknowledged.

**How to cancel distress alert**

You can cancel the distress alert while it is being sent or while waiting for its acknowledgment as follows.

1. Rotate the **ENTER** knob to select [CANCEL] in the user options area then push the knob.

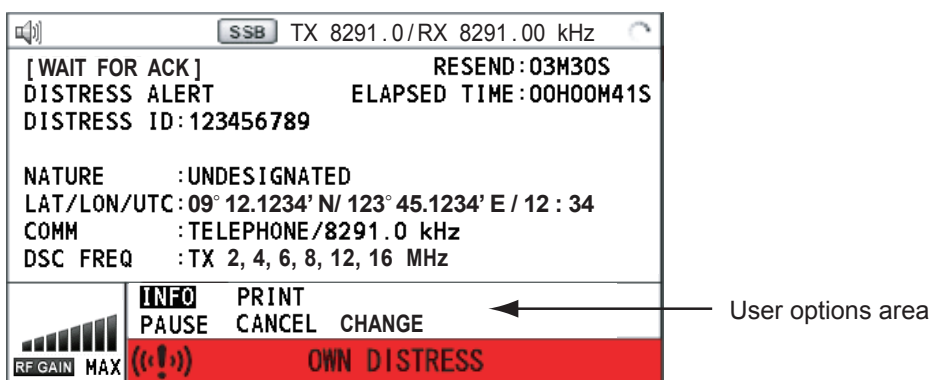

The following message appears on the screen.

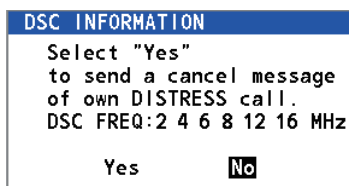

2. Rotate the **ENTER** knob to select [Yes] then push the knob to cancel the distress alert. After transmitting the distress cancel call, the following message appears on the screen.

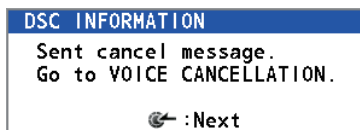

3. Push the **ENTER** knob to erase the message. The screen for the selection of frequency appears.

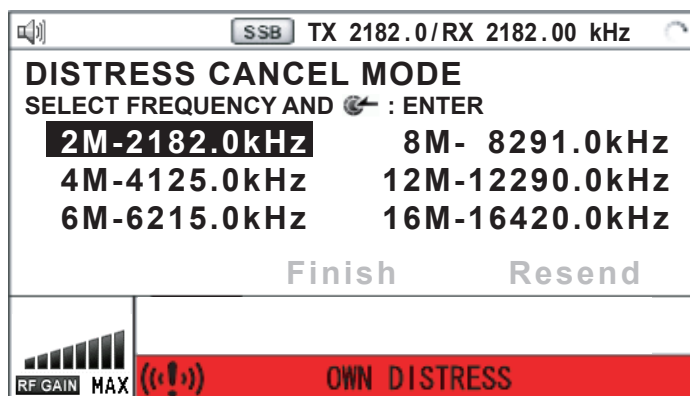

DISTRESS ALERT

4. Rotate the **ENTER** knob to select a frequency then push the knob. The following message appears on the screen.

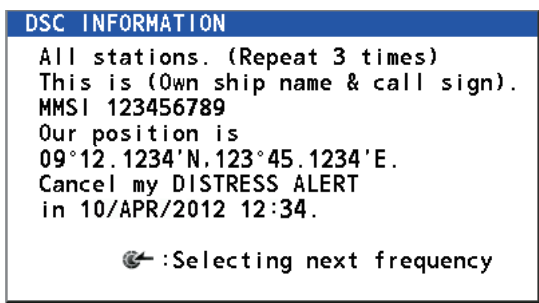

5. Communicate with all ships via radiotelephone referring to the message at step 4.
6. Push the **ENTER** knob. The screen for the selection of frequency appears again. The frequency marked by asterisk shows that the call cancellation by voice was completed for that frequency.

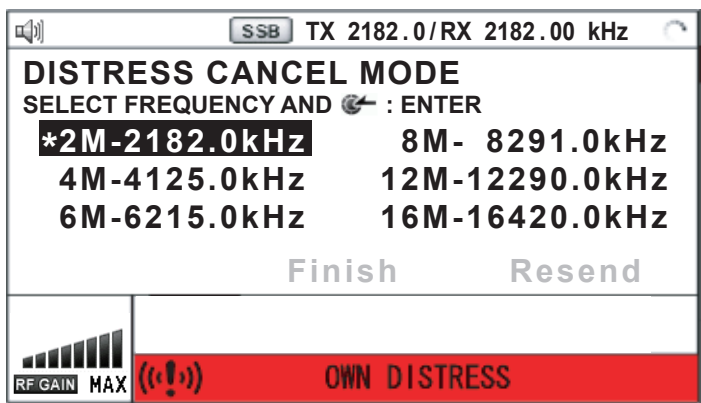

7. Repeat steps 4 through 6 to cancel for ALL frequencies. When cancellation on all frequencies is completed, the options [Finish] and [Resend] appear.

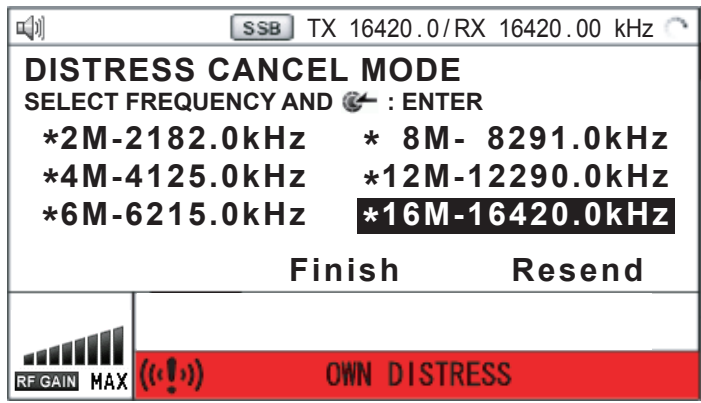

8. Rotate the **ENTER** knob to select [Finish] then push the knob.



# TABLE OF CONTENTS

---

<b>FOREWORD</b> .....	<b>xii</b>
<b>SYSTEM CONFIGURATIONS</b> .....	<b>xiv</b>
<b>1. OPERATIONAL OVERVIEW</b> .....	<b>1-1</b>
1.1 Controls .....	1-1
1.2 Handset .....	1-2
1.3 How to Turn On/Off the Power .....	1-3
1.4 Radiotelephone (RT) Screen.....	1-3
1.5 DSC Scan Screen .....	1-4
1.6 How to Adjust the Brilliance of the Display and Panel.....	1-5
1.7 How to Turn On/Off the Main Speaker .....	1-5
1.8 How to Scan .....	1-5
1.9 How to Set the Auto Acknowledgment .....	1-6
1.10 Control Unit Priority .....	1-6
1.11 Intercom.....	1-7
1.12 Operation of Session .....	1-7
<b>2. SSB RADIOTELEPHONE</b> .....	<b>2-1</b>
2.1 How to Select the Class of Emission.....	2-1
2.2 How to Select the Channel, Frequency .....	2-1
2.3 Transmission .....	2-3
2.3.1 Transmission procedure .....	2-3
2.3.2 How to change transmission power .....	2-3
2.3.3 Condition of the transmitter .....	2-4
2.4 Reception .....	2-5
2.4.1 RF gain (sensitivity) adjustment .....	2-5
2.4.2 S-meter.....	2-5
2.4.3 Receive AM broadcasting stations .....	2-5
2.4.4 Noise blanker .....	2-5
2.4.5 Noise reduction .....	2-5
2.4.6 Notch filter .....	2-6
2.4.7 Squelch .....	2-6
2.4.8 Attenuator.....	2-6
2.5 User Channels.....	2-6
<b>3. DSC OVERVIEW</b> .....	<b>3-1</b>
3.1 What is DSC? .....	3-1
3.2 DSC Message .....	3-1
3.3 Alarms .....	3-3
3.4 Description of Call Screens .....	3-4
3.4.1 RX calls .....	3-4
3.4.2 TX calls.....	3-5

<b>4.</b>	<b>DSC DISTRESS OPERATIONS .....</b>	<b>4-1</b>
4.1	How to Send Distress Alert .....	4-1
4.1.1	How to send distress alert by DISTRESS key with distress information not edited .....	4-1
4.1.2	How to send distress alert by DISTRESS key with distress information edited .....	4-3
4.2	How to Receive a Distress Alert.....	4-6
4.2.1	Distress alert received on MF band .....	4-7
4.2.2	Distress alert received on HF band.....	4-9
4.3	How to Send Distress Relay on Behalf of a Ship in Distress .....	4-11
4.3.1	How to send distress relay to coast station.....	4-11
4.3.2	How to send distress relay to ships in your area.....	4-13
4.4	How to Receive Distress Relay from Coast Station .....	4-15
4.5	How to Cancel Distress Alert .....	4-16
<b>5.</b>	<b>DSC GENERAL MESSAGE CALLING, RECEIVING.....</b>	<b>5-1</b>
5.1	Individual Call.....	5-2
5.1.1	How to send an individual call.....	5-2
5.1.2	How to receive an individual call .....	5-7
5.2	Group Call.....	5-10
5.2.1	How to send a group call.....	5-10
5.2.2	How to receive a group call.....	5-11
5.3	Geographical Area Call .....	5-12
5.3.1	How to send a geographical area call .....	5-12
5.3.2	How to receive a geographical area call .....	5-14
5.4	Neutral Craft Call.....	5-14
5.4.1	How to send a neutral craft call.....	5-14
5.4.2	How to receive a neutral craft call .....	5-16
5.5	Medical Transport Call .....	5-17
5.5.1	How to send a medical transport call .....	5-17
5.5.2	How to receive a medical transport call .....	5-18
5.6	How to Receive a Polling Request.....	5-19
5.6.1	Automatic reply .....	5-19
5.6.2	Manual reply.....	5-19
5.7	Position Call .....	5-20
5.7.1	How to request other ship's position .....	5-20
5.7.2	Other ship requests your position .....	5-22
5.8	PSTN Call .....	5-24
5.8.1	How to send a PSTN call.....	5-24
5.8.2	How to receive a PSTN call .....	5-26
<b>6.</b>	<b>MENU OPERATION.....</b>	<b>6-1</b>
6.1	How to Open/Close the MENU Screen .....	6-1
6.2	User Channels .....	6-2
6.2.1	List for user channels .....	6-2
6.2.2	How to register user channels.....	6-2
6.2.3	How to edit user channels.....	6-3
6.2.4	How to delete user channels.....	6-4
6.2.5	How to sort the USER CH list by band.....	6-4
6.2.6	How to select user channels for SSB mode.....	6-5
6.3	Log File .....	6-5
6.3.1	How to open a log file.....	6-5
6.3.2	How to delete log files .....	6-6
6.4	Squelch Frequency .....	6-7
6.5	Key Assignment .....	6-7
6.6	How to Print Messages .....	6-8

6.7	Position Setting.....	6-8
6.8	Date and Time Setting.....	6-9
6.9	Timeout Setting .....	6-10
6.10	FAX Enable/Disable .....	6-12
6.11	How to Select the Antenna.....	6-12
6.12	Clarifier Setting.....	6-13
6.13	External Alarm Setting.....	6-13
6.14	NETWORK Setting.....	6-14
6.15	Address Book .....	6-14
6.15.1	List for address data.....	6-14
6.15.2	How to register addresses.....	6-15
6.15.3	How to edit addresses.....	6-15
6.15.4	How to delete addresses.....	6-16
6.15.5	How to create a DSC message with registered address.....	6-17
6.16	TX Message Preparation.....	6-17
6.16.1	List for message files.....	6-17
6.16.2	Individual calls .....	6-18
6.16.3	Group calls .....	6-19
6.16.4	PSTN calls.....	6-20
6.16.5	Test call .....	6-20
6.16.6	How to edit prepared messages.....	6-21
6.16.7	How to send prepared messages.....	6-21
6.16.8	How to delete prepared messages.....	6-21
6.17	How to Set the AUTO ACK Details.....	6-22
6.18	Special Messages .....	6-23
6.19	How to Set Scan Frequencies .....	6-23
6.20	Sound Setting .....	6-25
6.21	Alarm List .....	6-26
<b>7.</b>	<b>NBDP SYSTEM OVERVIEW.....</b>	<b>7-1</b>
7.1	How to Turn on the NBDP System.....	7-1
7.2	Description of Equipment .....	7-1
7.2.1	Terminal unit.....	7-1
7.2.2	How to adjust of the brilliance of the terminal unit.....	7-3
7.2.3	How to switch to night mode .....	7-3
7.2.4	Keyboard .....	7-3
7.3	Encoding Setting .....	7-4
7.4	Function Keys, Menu Operation.....	7-5
7.4.1	Menu conventions .....	7-5
7.4.2	Menu overview .....	7-5
7.4.3	Function key description.....	7-6
<b>8.</b>	<b>NBDP PREPARATIONS.....</b>	<b>8-1</b>
8.1	Registration of Answerback & ID Codes .....	8-1
8.1.1	How to register answerback code .....	8-1
8.1.2	How to register ID codes .....	8-2
8.2	Station List.....	8-2
8.2.1	How to register stations.....	8-3
8.2.2	How to edit/delete stations .....	8-4
8.3	Timer Programming.....	8-4
8.3.1	How to register timer programs .....	8-4
8.3.2	How to edit/delete timer programs .....	8-5
8.4	Scan Channel Groups .....	8-6
8.4.1	How to register scan channel groups .....	8-6
8.4.2	How to edit/delete scan channel groups .....	8-7

## TABLE OF CONTENTS

8.5	How to Change the Window Color.....	8-8
8.6	Screen Saver Function.....	8-9
<b>9.</b>	<b>NBDP FILE OPERATIONS.....</b>	<b>9-1</b>
9.1	How to Open and Close Files.....	9-1
9.2	How to Create Files.....	9-1
9.3	How to Save a File.....	9-2
9.3.1	How to format floppy disks or SD cards.....	9-3
9.3.2	How to save a file.....	9-3
9.4	How to Edit Files.....	9-3
9.4.1	How to cut and paste text.....	9-3
9.4.2	How to copy and paste text.....	9-4
9.4.3	Select all.....	9-4
9.4.4	How to search text.....	9-5
9.4.5	How to replace text.....	9-5
9.4.6	Goto line.....	9-6
9.4.7	Goto top, Goto bottom.....	9-6
9.5	How to Open Files.....	9-7
9.5.1	Open a file.....	9-7
9.5.2	Switch between files.....	9-7
9.6	How to Rename Files.....	9-7
9.7	How to Save a File Under a New Name.....	9-8
9.8	How to Delete Files.....	9-8
9.9	Real Time Printing.....	9-8
9.10	How to Print Files.....	9-8
<b>10.</b>	<b>NBDP TRANSMISSION, RECEPTION.....</b>	<b>10-1</b>
10.1	Manual Calling.....	10-1
10.2	ARQ Mode Operation.....	10-3
10.3	FEC Mode Operation.....	10-5
10.4	How to Select Reception Mode.....	10-5
10.5	Communication Example.....	10-6
10.6	Timer Operation.....	10-8
10.6.1	How to enable timer operation.....	10-8
10.6.2	How to stop timer operation.....	10-8
10.7	Scanning.....	10-9
10.8	Communication Buffer.....	10-9
10.9	Preparation of Macrofiles for Automatic Telex.....	10-10
10.9.1	Automatic telex overview.....	10-10
10.9.2	Preparations.....	10-10
10.9.3	Commands.....	10-11
10.9.4	Store-and-forward method.....	10-13
10.10	Automatic Telex Using Macrofile.....	10-15

<b>11. MAINTENANCE &amp; TROUBLESHOOTING</b> .....	<b>11-1</b>
11.1 Test.....	11-1
11.2 Maintenance.....	11-3
11.3 Simple Troubleshooting.....	11-4
11.4 Error Messages.....	11-4
11.5 Breaker on PR-850A.....	11-5
11.6 Test Call.....	11-5
11.7 NBDP Terminal Unit Maintenance.....	11-6
11.7.1 Cleaning the equipment.....	11-6
11.7.2 Connectors and earth connection.....	11-6
11.7.3 Diagnostics.....	11-6
11.7.4 Power fuse.....	11-7
11.7.5 Notification messages.....	11-7
<b>APPENDIX 1 MENU TREE</b> .....	<b>AP-1</b>
<b>APPENDIX 2 FREQUENCY TABLES</b> .....	<b>AP-3</b>
<b>APPENDIX 3 LIST OF ABBREVIATIONS</b> .....	<b>AP-16</b>
<b>APPENDIX 4 DIGITAL INTERFACE (IEC 61162-1, IEC 61162-450)</b> .....	<b>AP-20</b>
<b>APPENDIX 5 PARTS LIST</b> .....	<b>AP-25</b>
<b>APPENDIX 6 PARTS LOCATION</b> .....	<b>AP-28</b>
<b>APPENDIX 7 ALERT LIST AND CODES</b> .....	<b>AP-33</b>
<b>SPECIFICATIONS</b> .....	<b>SP-1</b>
<b>INDEX</b> .....	<b>IN-1</b>

# FOREWORD

---

## A Word to the Owner of the FS-1575/2575/5075

Congratulations on your choice of the FURUNO FS-1575/2575/5075 SSB Radiotelephone. We are confident you will see why the FURUNO name has become synonymous with quality and reliability.

Since 1948, FURUNO Electric Company has enjoyed an enviable reputation for innovative and dependable marine electronics equipment. This dedication to excellence is furthered by our extensive global network of agents and dealers.

Your equipment is designed and constructed to meet the rigorous demands of the marine environment. However, no machine can perform its intended function unless properly installed and maintained. Please carefully read and follow the operation and maintenance procedures set forth in this manual.

We would appreciate feedback from you, the end-user, about whether we are achieving our purposes.

Thank you for considering and purchasing FURUNO equipment.

## Features

The FS-1575/2575/5075 is an MF/HF SSB Radiotelephone with a built-in DSC/Watch Receiver, all contained in a surprisingly compact cabinet. An NBDP (Narrow Band Direct Printing) Terminal Unit is optionally available.

Data is displayed on a large, easy-to-read color LCD. Operation is simplified by the use of few keys and easy-to-follow menus.

The built-in DSC/Watch Receiver produces and receives digital selective callings for quick and efficient establishment of distress, urgency, safety and routine communications with other ships and coast stations that install any MF/HF DSC facilities.

The main features are

### General

- Fully meets the following regulations: IMO A.806(19), IMO A.694(17), MSC 36(63), MSC 68(68), IEC 61162-1 Ed.4, IEC 61162-450, IEC 60945 Ed.4, ETS 300 067 Ed.1, EN 300 338, EN 300 373-1, EN 301 033, ITU-R M.476-5, ITU-R M.490, ITU-R M.491-1, ITU-R M.492-6, ITU-R M.493-14, ITU-R M.541-10, ITU-R M.625-3, ITU-R M.821-1, ITU-R M.1082-1, ITU-R M.1173, MSC/Circ. 862, IMO MSC. 302(87).
- Automatic entry of position with manual override
- Optional printer can automatically print out DSC and NBDP received messages and test results.

### DSC/Watch Receiver

- Distress, urgency, safety and routine calling
- Scanning of DSC frequencies for distress and general calls on MF/HF
- File editing capability for readiness in case of emergency
- PSTN (Public Switched Telephone Network) capability standard

- Log stores 50 each of latest general, distress and transmitted messages, in separate memory blocks.

### **SSB**

- Receiving voice communication
- Noise blanker function, Noise reduction function, Notch filter function, Squelch function are available.
- Simplified setting of channel and frequency

### **NBDP (with optional NBDP Terminal Unit IB-585)**

- Automatic error-free telex communications and distress message in compliance with GMDSS requirements
- LCD monitor and keyboard comply with ITU regulations
- Pop-up menus for user-friendly operation
- Memory for 256 operator-customized channels
- Real time message printing with Printer PP-520

## **Program Number**

### **FS-1575/2575/5075**

Location	PC board	Program No.	Version
FS-1575T/2575T/5075T	T-CPU (05P0859)	0550243 (APP)	02.xx
		0550247 (Boot)	01.xx
	MOT (05P0860)	0550245 (CPLD)	01.xx
FS-2575C	C-CPU (05P0852)	0550246 (Boot)	01.xx
ANTENNA COUPLER AT-5075	COUP (05P0875)	0550244	01.xx
ANTENNA COUPLER AT-1575	COUP (05P0883)	0550244	01.xx

xx: minor change

### **Terminal Unit IB-585 (optional unit)**

PC board	Program No.	Version
TERMINAL	0550251	02.xx

## **CE declaration**

With regards to CE declarations, please refer to our website ([www.furuno.com](http://www.furuno.com)), for further information about RoHS conformity declarations.

# SYSTEM CONFIGURATIONS

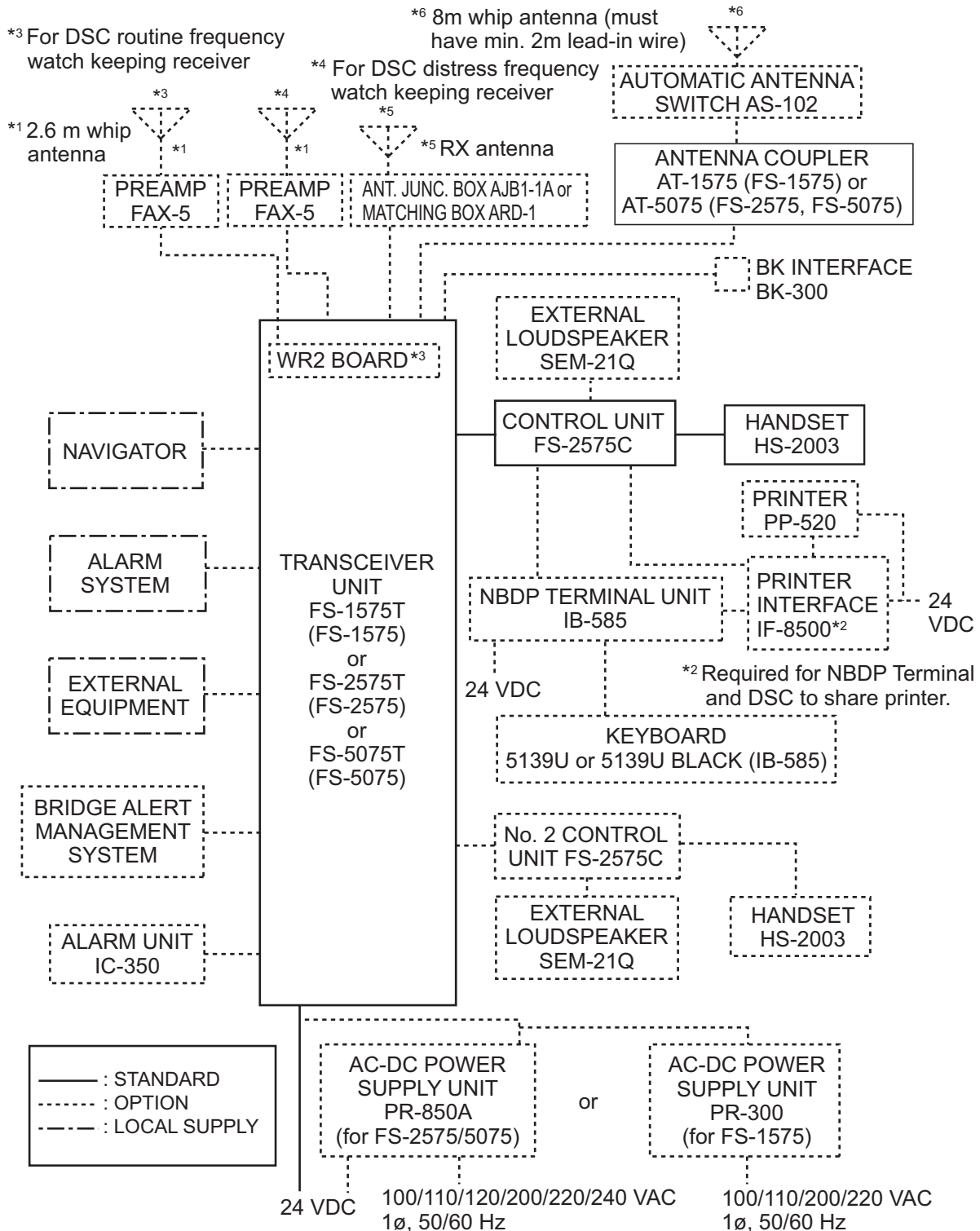

## CATEGORY OF UNITS (required by IEC60945):

Unit	Category
Preamp Unit	Exposed to the weather (For installation on the open deck)
Antenna Coupler	Exposed to the weather or protected from the weather (For installation on the open deck)
Other Units	Protected from the weather (For installation on the open deck)



# 1. OPERATIONAL OVERVIEW

## 1.1 Controls

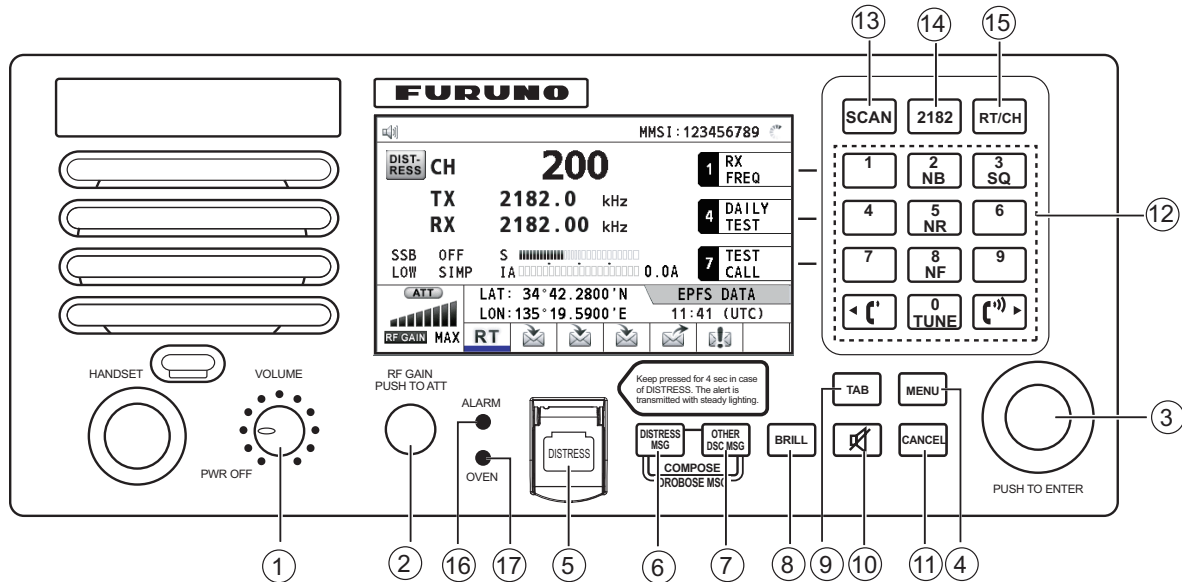

No.	Key	Function
①	<b>VOLUME/PWR</b> knob	<ul style="list-style-type: none"> <li>• Turns the power on or off.</li> <li>• Adjusts the volume.</li> </ul>
②	<b>RF GAIN/PUSH TO ATT</b> knob	Rotate to adjust the gain; push to turn the attenuator on or off.
③	<b>ENTER</b> knob	Rotate to select menu items or change the page in multi-page screens (e.g., log data); push to confirm a selection.
④	<b>MENU</b> key	Opens/closes the menu.
⑤	<b>DISTRESS</b> key	Press and hold down the key four seconds to transmit the distress alert. <b>Note:</b> The <b>DISTRESS</b> key is covered to prevent accidental operation.
⑥	<b>DISTRESS MSG</b> key*	Composes DSC TX message for DISTRESS ALERT.
⑦	<b>OTHER DSC MSG</b> key*	Composes DSC TX message except DISTRESS ALERT and DROBOSE (Distress Relay On Behalf Of Someone Else).
⑧	<b>BRILL</b> key	Adjusts the brilliance.
⑨	<b>TAB</b> key	<ul style="list-style-type: none"> <li>• Switches control to the tab area.</li> <li>• Switches the session.</li> </ul>
⑩	<b>🔊</b> key	Turns the main speaker on or off.

## 1. OPERATIONAL OVERVIEW

No.	Key	Function
⑪	<b>CANCEL</b> key	<ul style="list-style-type: none"> <li>• Cancels the creation of the DSC message currently being created.</li> <li>• Silences the audio alarm.</li> <li>• Erases error message or pop-up message.</li> <li>• Returns one layer in multi-layer menu.</li> <li>• Erases character input.</li> </ul>
⑫	<b>0 to 9</b> keys	Enter alphabet, numeric or symbol.
	<b>1, 4 and 7</b> keys	Execute the operation assigned to the function key in the RT mode.
	<b>2/NB</b> key	Turns the noise blanker on or off in the RT mode.
	<b>3/SQ</b> key	Turns the squelch on or off in the RT mode.
	<b>5/NR</b> key	Reduces the noise in the RT mode (NR2 (High), NR1 (Low), Off).
	<b>8/NF</b> key	Turns the notch filter on or off in the RT mode.
	<b>0/TUNE</b> key	Tunes the antenna in radiotelephone operation.
⑬	<b>SCAN</b> key	<ul style="list-style-type: none"> <li>• Opens the scan screen.</li> <li>• Stops/starts the scanning of DSC routine frequencies, on the scan screen.</li> </ul>
⑭	<b>2182</b> key	Switches to the RT (radiotelephone) screen and sets freq. to 2182.0 kHz.
⑮	<b>RT/CH</b> key	<ul style="list-style-type: none"> <li>• Switches to the RT (radiotelephone) screen.</li> <li>• Opens the CH setting window on the RT screen.</li> </ul>
⑯	<b>ALARM</b> lamp	<ul style="list-style-type: none"> <li>• Flashes in red for distress and urgency messages.</li> <li>• Flashes in green for safety and routine messages, and when daily test is completed.</li> </ul>
⑰	<b>OVEN</b> lamp	Lights in green when the main switchboard is on. <b>Note:</b> The OVEN lamp lights even if the power of the equipment is off.

\*: Press the **DISTRESS MSG** key and the **OTHER DSC MSG** key simultaneously to compose the DSC TX message for DROBOSE (Distress Relay On Behalf Of Someone Else).

### 1.2 Handset

The handset controls voice communications. Press the **PTT** (push-to-talk) switch to talk, and release it to listen for response. For the full-duplex communication (option required), simultaneous transmission and reception are possible. For the intercom communication (see section 1.11), it is not required to press the **PTT** switch to communicate.

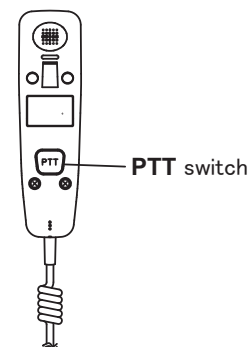

### 1.3 How to Turn On/Off the Power

Rotate the **VOLUME/PWR** knob clockwise to turn on the power. The RT screen appears.

To turn off the power, rotate the **VOLUME/PWR** knob counterclockwise to the OFF position.

In the dual control unit system, the No.1 control unit has priority and it controls the power for both itself and the No. 2 control unit. The power switch of the No. 2 control unit powers on/off the No. 2 control unit only.

**Note:** Turn on the power at the switchboard more than 15 minutes before turning on this equipment.

### 1.4 Radiotelephone (RT) Screen

Turn the power on, or press the **RT/CH** key to show the RT (radiotelephone) screen. This is where you set up the transceiver unit, and communicate by voice or telex.

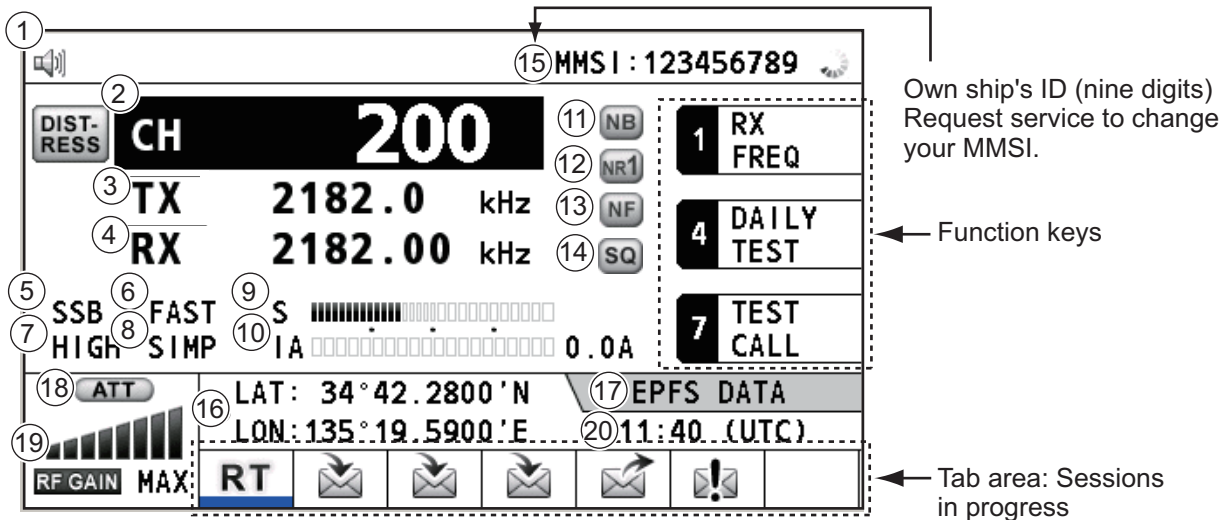

Radiotelephone (RT) screen

No.	Indication	Meaning
①	🔊/🔇	Main speaker on or off
②	CH	Channel
③	TX	TX frequency ([TX]: while transmitting)
④	RX	RX frequency
⑤	SSB/TLX/AM/FAX	Class of emission
⑥	OFF/SLOW/FAST (AGC)	Auto gain control ([OFF]: no adjustment, [SLOW]: low-speed, [FAST]: high-speed)
⑦	HIGH/MID/LOW(1)/LOW2	Output power ([LOW2]: FS-5075 only, minimum output power)

1. OPERATIONAL OVERVIEW

No.	Indication	Meaning
⑧	SIMP/S-DUP/DUP	Communication mode ([SIMP]: simplex, [S-DUP]: semi-duplex, [DUP]: full-duplex (only for FS-5075, option))
⑨	S	S-meter, displays the strength of received signal.
⑩	IA/IC/VC/RF/VS	Transceiver unit status ([IA]: antenna current, [IC]: collector current, [VC]: collector voltage, [RF]: RF output, [VS]: source voltage)
⑪	NB	Noise blanker (NB: On, No indication: Off)
⑫	NR2/NR1/OFF	Noise reduction (NR2: High, NR1: Low, No indication: Off)
⑬	NF	Notch filter (NF: On, No indication: Off)
⑭	SQ	Squelch (SQ: On, No indication: Off)
⑮	MMSI	Own ship's ID (nine digits) <b>Note:</b> Request service to change your MMSI.
⑯	LAT, LON	Own ship's position (LAT: Latitude, LON: Longitude)
⑰	EPFS DATA/EPFS (OFFLINE)/ EPFS (OLD)/ MANUAL INPUT/NO INFO	Method of the position data input [EPFS DATA]: The position and time data from EPFS. [EPFS (OFFLINE)]: Indicates no position data from EPFS for ten minutes. [EPFS (OLD)]: Indicates no position data from EPFS for four hours. [MANUAL INPUT]: Set the position and time data manually. [NO INFO]: No position and time data.
⑱	ATT	Attenuator (ATT: On, No indication: Off)
⑲	RF GAIN	Adjusted value of gain
⑳	Time (UTC: universal time coordinated) of the position fix	

## 1.5 DSC Scan Screen

Press the **SCAN** key to show the DSC scan screen. This screen scans and receives the distress and routine frequencies.

The screenshot shows the DSC Scan Screen with the following data:

WATCH KEEPING		
DISTRESS	WR	
▶ 2187.5	4207.5	6312.0
8414.5	12577.0	16804.5
ROUTINE	RX	
▶ 2177.0	4219.5	6331.0
8436.5	12657.0	16903.0

Additional information on the screen includes:

- MMSI: 123456789
- LAT: 34°42.2800' N
- LON: 135°19.5900' E
- EPFS DATA: 11:41 (UTC)
- RF GAIN: 20
- RT (Repeat Transfer) icon
- Alert icons (envelopes and exclamation mark)

Annotations:

- RX: Transceiver unit (WR2 shown when optional antenna for routine frequencies is installed.)
- Maximum six distress and routine frequencies scanned.

## 1.6 How to Adjust the Brilliance of the Display and Panel

You can adjust the brilliance of the display and the panel as follows:

1. Press the **BRILL** key to show the [BRILL LEVEL SETUP] window.

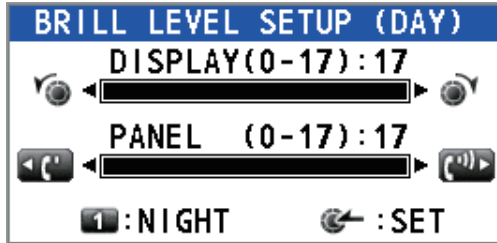

2. Press the **1** key to switch the [DAY/NIGHT] mode.
3. To adjust the [DISPLAY] brilliance, rotate the **ENTER** knob or press the **BRILL** key.  
(Default setting: 17 for [DAY], 7 for [NIGHT])
4. To adjust the [PANEL] brilliance, press the **←** or **→** key.  
(Default setting: 17 for [DAY], 12 for [NIGHT])
5. Push the **ENTER** knob to save the settings and close the window. To cancel the settings, press the **CANCEL** key instead of the **ENTER** knob to close the window.

**Note 1:** The equipment keeps values for [DAY] and [NIGHT] separately.

**Note 2:** The window closes automatically when there is no operation for four seconds.

**Note 3:** When you turn on the power with the display brilliance set to 0, the setting automatically changes to 1.

## 1.7 How to Turn On/Off the Main Speaker

You can turn the main speaker (other than DSC communication, error, and key beep) on/off.

1. Press the  key to alternately disable or enable the main speaker.



Speaker ON



Speaker OFF

2. To adjust the volume of the main speaker, rotate the **VOLUME/PWR** knob (cw: volume up, ccw: volume down).

## 1.8 How to Scan

The DSC screen scans multiple routine frequencies according to operator-set interval. For how to set frequency to scan, see section 6.19.

**Note:** The voice and telex communication are not available when scanning.

## 1. OPERATIONAL OVERVIEW

1. Press the **SCAN** key to show the DSC scan screen. Scanning starts. When receiving the appropriate frequency signal, the scanning stops, and the frequency is highlighted and flashes.
2. Press the **SCAN** key again to stop scanning the routine frequencies.  
**Note:** You can not stop the scanning manually for the distress alert.
3. Rotate the **ENTER** knob to move the cursor to the desired routine frequency which you want to watch. You can scan only the frequency selected by cursor.
4. Press the **SCAN** key to restart the scanning.

**Note:** When scanning starts, the active session (refer to section 1.12) is automatically put on hold.

### 1.9 How to Set the Auto Acknowledgment

Individual, PSTN (public switched telephone network), position, polling and test calls can be acknowledged automatically or manually. This is set on the [ACK SETTINGS] in the [DSC] menu (see section 6.17).

**Note:** When own ship's communication is high priority, set to manual acknowledgment.

The auto acknowledgment is not sent in the following cases:

- Other session is active (except individual call).
- There are RT or DSC sessions (for individual call).
- Channel is in use.
- ECC is NG (No Good).

**Note:** The auto acknowledgment for the individual call is sent only when the proposed channel or communication mode is not available.

### 1.10 Control Unit Priority

If you operate the No.1 control unit while the No.2 control unit is being operated, the right to operate is shifted to the No.1 control unit. The control unit not having priority shows the following:

- The unit name currently in use: No.1 control unit, No.2 control unit or NBDP
- The ongoing operation: COMPOSING DSC MESSAGE, OPERATION, COMMUNICATION

The control unit which you operate has priority in the following conditions:

- The handset goes OFF HOOK.
- Display the menus or setting windows.
- Display each function screen (for example, Log).
- Press a key or rotate a knob. (The priority is lost after four seconds.)
- NBDP is communicating.

## 1.11 Intercom

The built-in intercom permits voice communications between two control units.

### Calling

You can call over the intercom in on or off hook condition.

1. Press the **MENU** key.
2. Rotate the **ENTER** knob to select [INTERCOM] then push the knob. The pop-up for calling appears and the called party's control unit rings. To cancel calling, press the **CANCEL** key.
3. When the called party picks up their handset, the pop-up for calling disappears and the INTERCOM CONNECTED screen appears. Start communications.  
**Note:** You do not have to press the **PTT** switch to communicate.
4. If needed, adjust the handset volume with **<C** or **C>** key.
5. Hang up the handset or press the **CANCEL** key to turn the intercom off. The last-used screen or the RT screen appears.

### Answering

1. The control unit rings, and both the pop-up for calling and a message, which suggests you to pick up the handset, appear. To cancel reply, press the **CANCEL** key.
2. Pick up the handset, and the alarm stops. The pop-up for calling disappears and the INTERCOM CONNECTED screen appears. Start communications.
3. Hang up the handset or press the **CANCEL** key to turn the intercom off. The last-used screen or the RT screen appears.

## 1.12 Operation of Session

### Description of session

There are two types of sessions: RT session and DSC session. When a session starts, the appropriate icon for the session appears in the tab area.

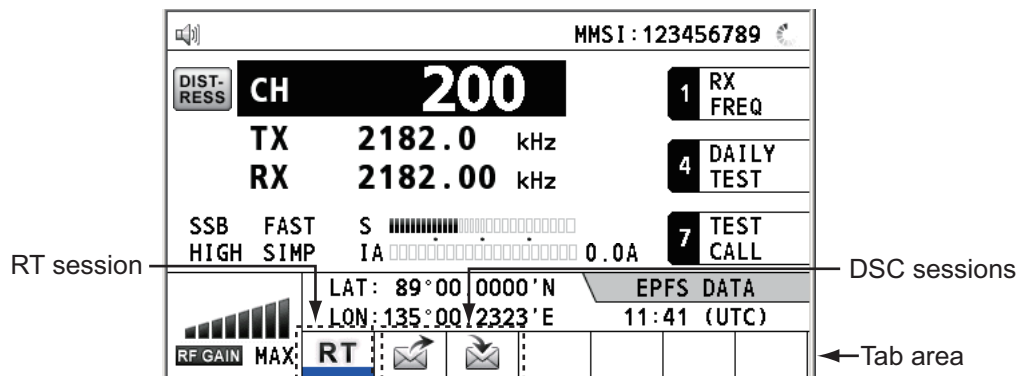

## 1. OPERATIONAL OVERVIEW

### How to finish a single session

#### RT session

1. Press the **TAB** key to select the RT icon in the tab area.
2. Rotate the **ENTER** knob to select [QUIT] then push the knob.

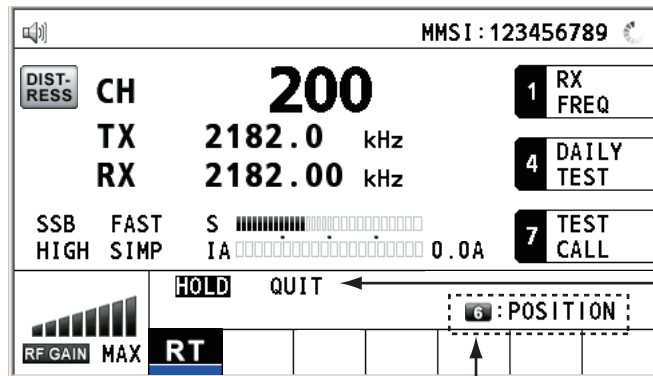

Step 1: Press the **TAB** key to select the RT icon.

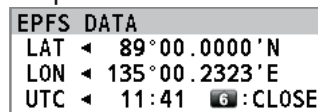

Step 2: Rotate the **ENTER** knob to select [QUIT].

Press the **6** key to open the position data window.

#### DSC session

The cursor is in the tab area when the DSC session starts. Rotate the **ENTER** knob to select [QUIT] then push the knob.



Rotate the **ENTER** knob to select [QUIT].

### How to start a new session

#### When another session is active:

- When sending the distress alert, all sessions except the distress alert TX session automatically close then the distress alert TX session starts.
- When doing an RT session or sending a non-distress DSC message, the currently active session is put on hold then the RT session or non-distress DSC message TX session starts.
- When receiving a DSC message, its session is put on hold.

#### When no other session is active:

- When sending the distress alert, all sessions except the distress alert TX session automatically close then the distress alert TX session starts.
- When sending a non-distress DSC message, its session becomes the active session.



**How to switch sessions**

When one session is active and another message arrives, a new session for the received message does not start automatically. Only one session can be active. For example, when you are transmitting a DSC message and another message arrives, the option [ACTIVE] appears to indicate the start of a new session.

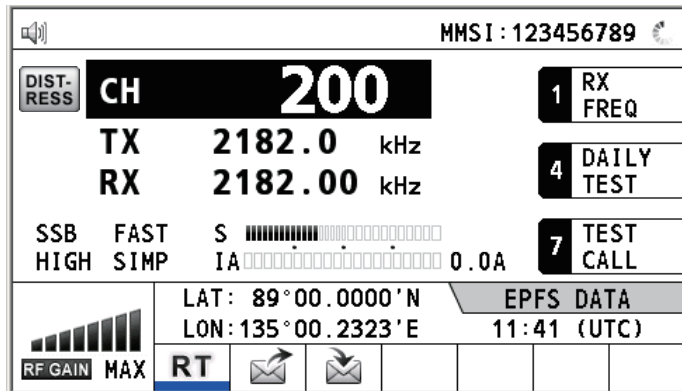

Press the **TAB** key to move the cursor to the tab area.

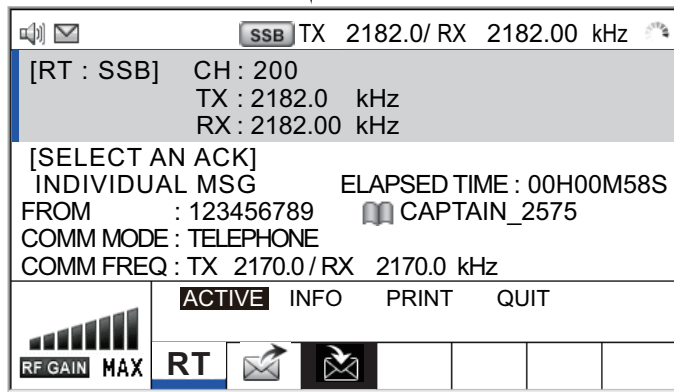

Information for the session underlined in blue (RT in this case)

Information for the session selected by cursor.

← User options area

← Tab area

To select a session, press the **TAB** key. The cursor is here.

With [ACTIVE] selected, push the **ENTER** knob to switch the active session. To switch the option for the session (ACTIVE, INFO, PRINT, QUIT), rotate the **ENTER** knob.



Only the screen for the selected session appears.

To finish this session, rotate the **ENTER** knob to select [QUIT] then push the knob.

**Note:** When waiting for the ACK, that is, the session is in progress, the confirmation message appears. Rotate the **ENTER** knob to select [YES] or [NO] then push the knob.

(Continued on next page)

## 1. OPERATIONAL OVERVIEW

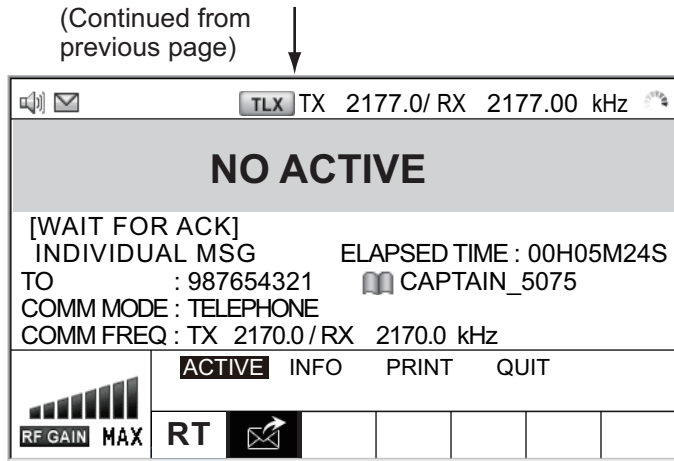

The  icon disappears.

### How to close a session

To manually close a session, select it with the **TAB** key. Rotate the **ENTER** knob to select [QUIT] in the user options area then push the knob. The session icon disappears from the tab area.

When there is no operation for specific time (see section 6.9), the inactive session is automatically closed.

### Processing when the number of session is maximum

A maximum of seven sessions can be displayed in the tab area. If a seventh session starts, the following message appears on the screen. Press the **CANCEL** key to close the message. Close a session to make space for the new session.

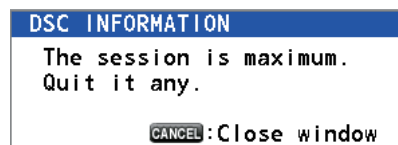

If the eighth session is for sending a distress alert, all sessions except that session automatically close, and the session starts.

If the eighth session is for receiving DSC message, the lowest-priority session automatically closes and the message appears.

## 2. SSB RADIOTELEPHONE

You can do SSB communications from any screen which displays the communication frequency.

### 2.1 How to Select the Class of Emission

You can select the class of emission from among the following:

- [SSB]: Single Sideband
- [TLX]: Telex
- [AM]: AM (RX only)
- [FAX]: FAX (RX only. Connect a FAX to this equipment to print FAX messages.)

At the RT screen, select the class of emission as follows:

1. Rotate the **ENTER** knob to highlight the class of emission (default: [SSB]) then push the knob. When you rotate the **ENTER** knob clockwise, the cursor moves from [CH] downward.

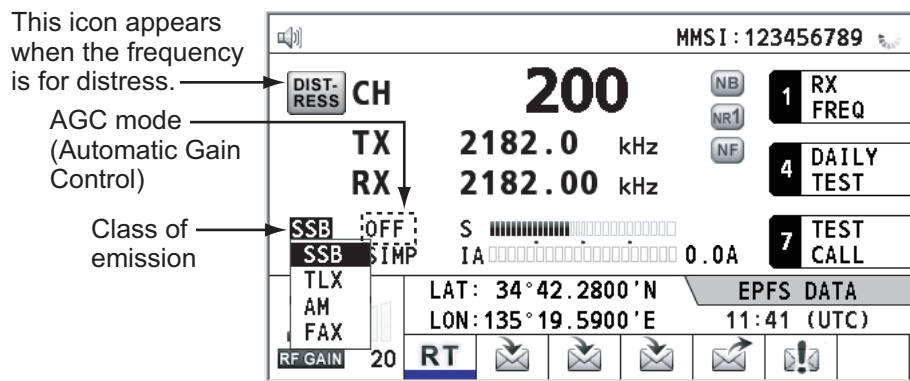

2. Rotate the **ENTER** knob to select the class of emission desired then push the knob. AGC is automatically turned on or off according to the class of emission.

- [SSB]: [FAST]                      • [TLX], [FAX]: [OFF]                      • [AM]: [SLOW]

3. You can change AGC as below.

- 1) Rotate the **ENTER** knob to select the AGC mode indication then push the knob.



- 2) Rotate the **ENTER** knob to select [OFF], [SLOW] or [FAST] then push the knob.

### 2.2 How to Select the Channel, Frequency

Select the channel or transmitting/receiving frequency to use for the SSB.

**Note:** To set the SSB radiotelephone to 2182 kHz/J3E, press the **2182** key.

**Channel**

1. Rotate the **ENTER** knob to select [CH] on the RT screen then push the knob. You can also show the channel setting window by pressing the **RT/CH** key.

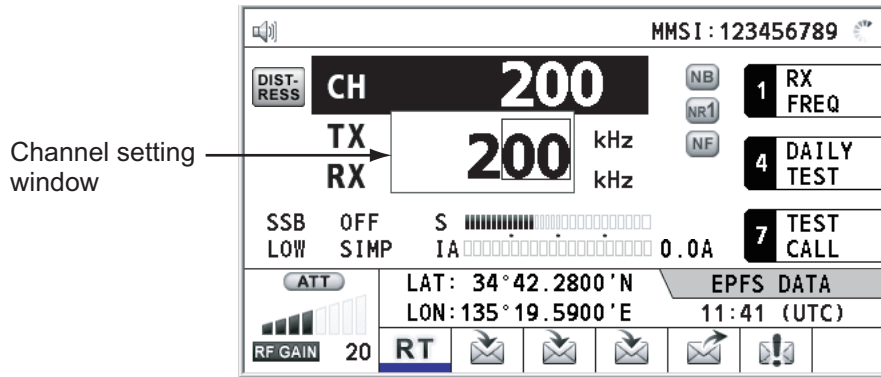

2. A channel can be entered directly with the numeric keys, or by using the **ENTER** knob. See below for details.

Enter channel with the numeric keys:

Use the numeric keys to enter channel then push the **ENTER** knob.

Select band and band channel with the **ENTER** knob:

- 1) Use the **←** or **→** key to place the cursor in the band or band channel position, whichever you want to change.



Cursor position for selection of band



Cursor position for selection of band channel

- 2) Rotate the **ENTER** knob to set band or band channel desired.

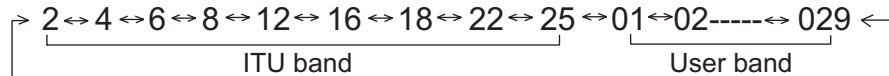

Setting Range

ITU Band (SSB, TLX): 2/4/6/8/12/16/18/22/25

ITU Band (CW): 4/6/8/12/16/22/25

User Band: 01-029 (First zero is necessary)

ITU Channel (SSB): 00 - XX

ITU Channel (TLX): 000 - XXX

ITU Channel (CW): 001 - XXX

User Channel: 01 - 99

- 3) Push the **ENTER** knob to close the setting window.

**Frequency**

1. Rotate the **ENTER** knob to select [TX] or [RX] then push the knob.



2. Enter frequency by one of the methods below.

Enter frequency with the numeric keys:

Use the numeric keys to enter frequency then push the **ENTER** knob. For example, to enter 2161 kHz, key in 2, 1, 6, 1, 0. (Note: Keying in 2-1-6-1 sets 216.1 kHz.) Be sure to include zero for 100 Hz place.

Select frequency with the **ENTER** knob (for RX only):

- 1) Use the **←** or **→** key to change the range which the cursor covers.
- 2) Rotate the **ENTER** knob to set frequency desired.
- 3) Push the **ENTER** knob to close the setting window.

**Note:** When TX and RX frequencies are different, first enter TX then enter RX.

## 2.3 Transmission

After selecting the class of emission and frequency, you can transmit by pressing the **PTT** switch on the handset.

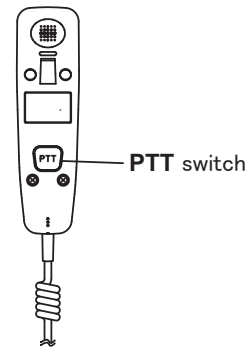

### 2.3.1 Transmission procedure

Maximum transmission power is achieved only when the antenna impedance and transmitter impedance match each other. Because the antenna impedance changes with frequency, antenna impedance matching with the transmitter impedance is done with the antenna coupler. The antenna coupler automatically tunes the transmitter to a wide range of different antenna lengths. The available range is;

- Wire antenna 10 to 18 meters long (horizontal part)
- Whip antenna eight meters long (Horizontal feeder is two meters or longer.)
- Whip antenna 10 meters long

To initiate the tuning, do the following:

1. Press the **PTT** switch on the handset. Tuning is automatically adjusted at first transmission after frequency is changed. For manual tuning, press the **0/TUNE** key on the RT screen. If tuning fails, the message "TUNE NG" appears and the output power is automatically set to [LOW] (for FS-1575/2575) or [LOW2] (for FS-5075).
2. Hold the handset close to your mouth, press the **PTT** switch and speak clearly.

**Note:** When tuning is initiated in the two control unit system, the screen of the idle control unit shows "OCCUPIED (CONTROLLER 1 (or 2))". In this case, only the **DISTRESS** key is operative on the idle control unit.

### 2.3.2 How to change transmission power

To minimize possible interference to other stations, reduce the transmission power. This should be done when using the transceiver in a harbor, near the shore or close to communication partner (other ship).

1. Rotate the **ENTER** knob to select [HIGH], [MID], [LOW] (for FS-1575/2575), [LOW1] (for FS-5075) or [LOW2] (for FS-5075) (whichever is displayed), then push the knob.

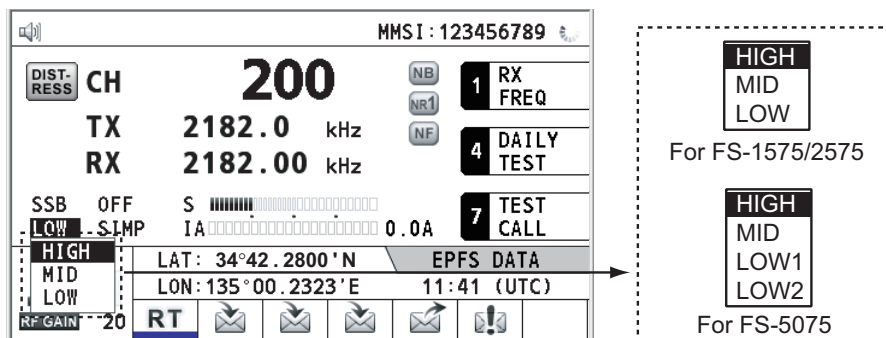

2. SSB RADIOTELEPHONE

2. Rotate the **ENTER** knob to select the option desired then push the knob.

	FS-1575/2575	FS-5075
[HIGH]	No reducing	
[MID]	125 Wpep	350 Wpep
[LOW]	90 Wpep	-
[LOW1]	-	200 Wpep
[LOW2]	-	110 Wpep

**Note:** The temperature of the power amplifier is monitored. When its temperature rises above a certain temperature, output power is automatically reduced.

### 2.3.3 Condition of the transmitter

While transmitting, you can display [IA] (antenna current), [IC] (collector current), [VC] (collector voltage), [RF] (RF output) or [VS] (source voltage) on the RT screen.

1. Rotate the **ENTER** knob to select [IA], [IC], [VC], [RF] or [VS] (whichever is displayed) then push the knob.

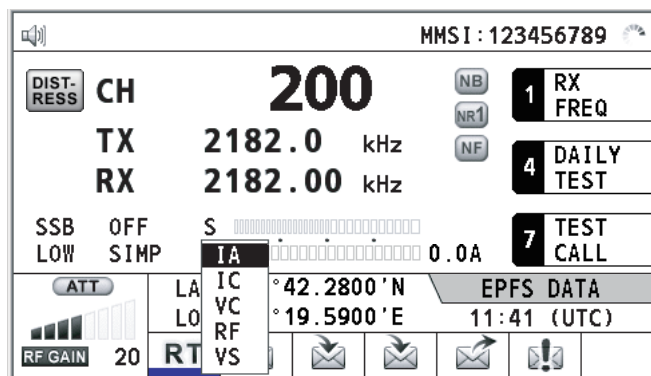

2. Rotate the **ENTER** knob to select the option desired then push the knob.

#### Check the transmission power

During transmission, the IA bar deflects according to the current being fed from the antenna coupler to the antenna feeder. The unit of readout is amperes. The antenna current varies with the effective antenna impedance. The reading differs by the frequency and antenna length. The output power is proportional to the square of an antenna current.

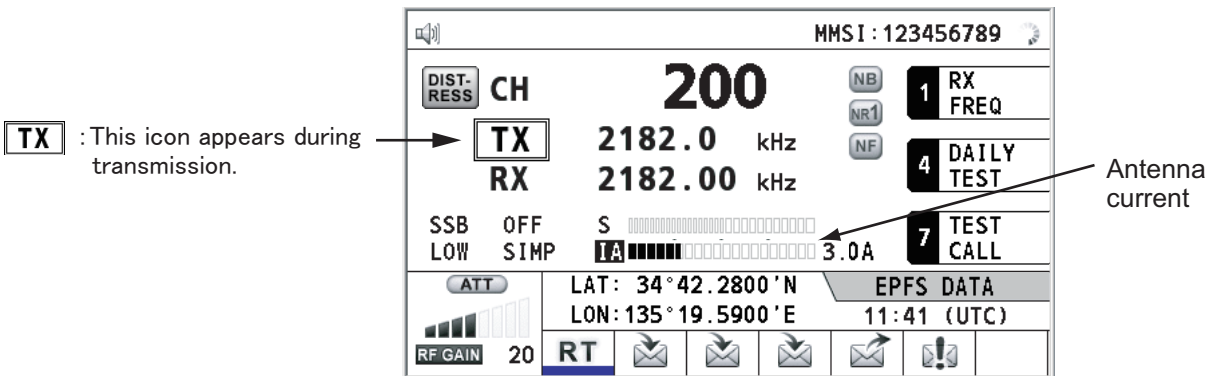

## 2.4 Reception

Check if the class of emission and receiving frequency are set properly. If necessary, set them again referring to sections 2.1 and 2.2.

### 2.4.1 RF gain (sensitivity) adjustment

In normal use the sensitivity should be set for maximum. If the audio on the received channel is unclear or interfered with other signals, adjust (usually reduce) sensitivity to improve clarity.

Rotate the **RF GAIN/PUSH TO ATT** knob to adjust gain (sensitivity). The setting value is displayed at the lower left-hand side of the screen, with analog and digital indications.



### 2.4.2 S-meter

The S-meter shows relative signal strength coming into the receiver front end.

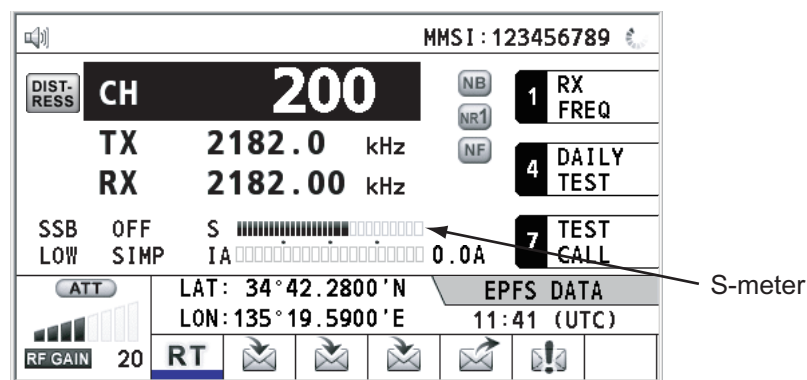

### 2.4.3 Receive AM broadcasting stations

1. If the RT screen is not displayed, press the **RT/CH** key to display the RT screen.
2. Rotate the **ENTER** knob to select the current class of emission then push the knob.
3. Rotate the **ENTER** knob to select [AM] then push the knob (see section 2.1).
4. Rotate the **ENTER** knob to select [RX] then push the knob.
5. Enter RX frequency with the numeric keys then push the **ENTER** knob (see "Frequency" in section 2.2).

### 2.4.4 Noise blanker

The noise blanker removes pulse noise. Press the **2/NB** key on the RT screen to turn the noise blanker on and off alternately. When the noise blanker function is active, **NB** is displayed on the RT screen.

### 2.4.5 Noise reduction

The noise reduction circuit analyzes speech component and noise component, and reduces only noise component. Press the **5/NR** key on the RT screen. Each time you press the **5/NR** key, the effect of noise reduction changes in the sequence of ([NR2]

## 2. SSB RADIOTELEPHONE

(High) → [NR1] (Low) → Off). When the noise reduction function is active, **NR2** or **NR1** is displayed on the RT screen.

### 2.4.6 Notch filter

The notch filter removes mixed CW (continuous wave) or beat signal interference. Press the **8/NF** key on the RT screen to turn the notch filter on and off alternately.

When the notch filter function is active, **NF** is displayed on the RT screen.

### 2.4.7 Squelch

#### Squelch on/off

The squelch mutes the audio output in the absence of an incoming signal. Press the **3/SQ** key on the RT screen to turn the squelch on and off alternately. When radio noise is too jarring during stand-by condition, it can be muted by activating the squelch.

When the squelch function is active, **SQ** is displayed on the RT screen.

#### Squelch frequency

To adjust the squelch frequency, see section 6.4.

### 2.4.8 Attenuator

The attenuator reduces total gain and prevents saturation. Push the **RF GAIN/PUSH TO ATT** knob on the RT screen to turn the attenuator on and off alternately. When the attenuator function is active, **ATT** is displayed on the RT screen.

## 2.5 User Channels

The [USER CH] menu provides for registration of user TX and RX channels, where permitted. For further details, contact your dealer. See section 6.2 for the procedure.

### NOTICE

**FURUNO will assume no responsibility for the disturbance caused by the unlawful or improper setting of user channels.**



# 3. DSC OVERVIEW

## 3.1 What is DSC?

DSC is an acronym meaning Digital Selective Calling. It is a digital distress and general calling system in the MF and HF bands used by ships for transmitting distress alerts and general calls and by coast stations for transmitting the associated acknowledgments.

For DSC distress, safety and urgency callings in the MF and HF bands, the frequencies are 2187.5, 4207.5, 6312.0, 8414.5, 12577.0, and 16804.5 kHz.

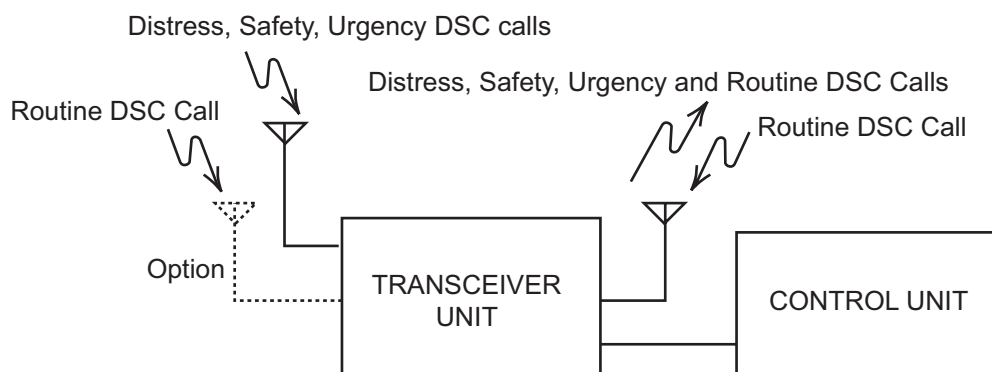

## 3.2 DSC Message

DSC calls are roughly divided in two groups: distress messages and general (safety, urgency and routine) messages. Below are the types of DSC messages.

Call	Description
DISTRESS ALERT	Your ship sends distress message.
DISTRESS RELAY AREA	Your ship relays distress call to all ships in a specific geographical area.
DISTRESS RELAY INDIVIDUAL	Your ship relays distress call to a coast station.
MEDICAL MSG*	Inform areas that your ship is carrying medical supplies.
NEUTRAL MSG*	Inform areas that your ship is not a participant in armed conflict.
INDIVIDUAL MSG	Call to a specific address.
PSTN MSG	Call over Public Switched Telephone Network (PSTN).
TEST MSG	Send test signal to a station to test your station's functionality.
GROUP MSG	Call to a specific group.
AREA MSG	Call to all ships in a specific geographical area.
POSITION MSG	Your ship requests position of other ships.
POLLING MSG	Confirm if your ship is within communicating range with other ships. (Receive and answer only)

\*SPECIAL MSG: To send these messages, set [SPECIAL MSG] to [ABLE]. See section 6.18.

**Contents of a DSC call**

• **Calling category**

Call category	Call
DISTRESS	DISTRESS ALERT, DISTRESS RELAY AREA, DISTRESS RELAY INDIVIDUAL
GENERAL	MEDICAL MSG, NEUTRAL MSG, INDIVIDUAL MSG, PSTN MSG, TEST MSG, GROUP MSG, AREA MSG, POSITION MSG, POLLING MSG

• **Station ID (MMSI)**

Your ship ID and sending station ID. Coast station ID begins with 00; Group ID begins with 0.

• **Priority**

**Distress:** Grave and imminent danger and request immediate assistance.

**Urgency:** A calling station has a very urgent call to transmit concerning safety of ship, aircraft or other vehicle or safety of person.

**Safety:** A station is about to transmit a call containing an important navigational or meteorological warning.

**Routine:** General calling

• **Communication mode**

**TELEPHONE:** Telephone (J3E) by SSB radiotelephone

**NBDP-ARQ\*:** Telex (J2B) mode ARQ via NBDP Terminal Unit

**NBDP-FEC\*:** Telex (J2B) mode FEC via NBDP Terminal Unit

\*: NBDP terminal unit is required.

• **Communication frequency**

Working frequency used to call by telephone or NBDP. The sending station may have the receiving station (ship or coast station) assign the frequency to use.

• **Position**

Position can be automatically or manually set. Own ship's position (LAT/LON) is sent with four decimal places automatically in case of the distress alert.

• **DSC frequency**

DSC frequency to use. If the call priority is SAFETY, URGENCY or DISTRESS, select a DSC distress frequency.

• **End code**

The end of a DSC call is indicated with "EOS" (acknowledgment, acknowledgment required, no acknowledgment required).

### 3.3 Alarms

When you receive a distress alert or general call addressed to your ship, the audio alarm sounds and a pop-up message appears. The alert/alarm icon also flashes. Pressing the **CANCEL** key will stop the audio alarm sound, close the pop-up and clear the flashing icon.

Alarm	Frequency (interval)
Safety call received	750 Hz and 650 Hz (50 ms)
Routine call received	750 Hz and 650 Hz (50 ms)
While <b>DISTRESS</b> key is pressed for four seconds	2000 Hz and 0 Hz (500 ms)
Distress alert sent	2200 Hz, continuous (2 seconds)
Own ship position not updated	2000 Hz (250 ms) and 0 Hz (500 ms)
Distress alert call received	2200 Hz and 1300 Hz (250 ms)
Distress relay call received	2200 Hz and 1300 Hz (250 ms)
Distress relay ack call received	2200 Hz (500 ms) and 1300 Hz (500 ms)
Distress ack call received	2200 Hz (500 ms) and 1300 Hz (500 ms)
Urgency call received	2200 Hz and 0 Hz (250 ms)
Urgency ack call received	2200 Hz and 0 Hz (500 ms)

## 3.4 Description of Call Screens

This section provides the information necessary for interpreting the receive and send call screens.

### 3.4.1 RX calls

Below are sample distress alert and individual RX call screens. The contents of other types of RX calls are similar to that of the individual call.

#### Distress alert

The screenshot shows a DSC receiving screen for a distress alert. The top status bar displays 'SSB TX 8291.0/RX 8291.00 kHz'. The main display area contains the following information: '[WAIT FOR ACK]', 'DISTRESS ALERT', 'ELAPSED TIME: 00H00M41S', 'DISTRESS ID: 123456789', 'NATURE: UNDESIGNATED', 'DISTANCE: 1234 NM', 'LAT/LON/UTC: 34°42.2800'N/135°19.5900'W/14:12', 'COMM: TELEPHONE/8291.0 kHz', and 'DSC FREQ: RX MULTI 2 4 6 8 12 kHz'. The bottom section features a menu with options: 'INFO', 'HISTORY', 'PRINT', 'HOLD', 'QUIT', 'RELAY', 'ACK', and 'CHANGE'. The RF gain is set to 'MAX'. Annotations on the left side point to the speaker icon, call type, ID No. (MMSI) of ship in distress, nature of distress, communication mode and suggested channel, and RF gain. Annotations on the right side point to the working frequency to use, elapsed time since distress alert received, distance to ship in distress, position of ship in distress, DSC frequency, available user options, and session in progress.

#### Individual RX call

The screenshot shows a DSC receiving screen for an individual message. The top status bar displays 'TLX TX 2177.0 /RX 2177.00kHz'. The main display area contains the following information: '[SELECT AN ACK]', 'INDIVIDUAL MSG', 'ELAPSED TIME: 00H00M16S', 'FROM: 123456789', 'COMM MODE: TELEPHONE', and 'COMM FREQ: TX 2170.0/RX 2170.0 kHz'. The bottom section features a menu with options: 'INFO', 'PRINT', 'HOLD', 'QUIT', 'ACCEPT', 'UNABLE', and 'PROPOSE'. The RF gain is set to '25'. Annotations on the left side point to the speaker icon, call type, ID No. (MMSI) of ship sending this message, communication frequency, and RF gain. Annotations on the right side point to the working frequency to use, elapsed time since call received, communication mode, available user options, and session in progress.

The marks "\*\*\*", "-." appear on the DSC receiving screen in the following conditions:

- "\*\*\*" indicates a corrupt character in received data.
- "-." indicates missing digits after decimal point when receiving position data with no info for expansion (expansion: digits after decimal point).

Examples:

- 1) When receiving position data without expansion, the indication is "LAT: 12°34'N".
- 2) When receiving position data with expansion, the indication is "LAT: 12°34,5678'N".
- 3) When receiving position data with no info for expansion, the indication is "LAT: 12°34,----'N".

### 3.4.2 TX calls

Below are sample distress alert and individual TX call screens. The contents of other types of TX calls are similar to that of the individual call.

#### Distress alert

SSB TX 8291.0/RX 8291.00 kHz

**COMPOSE MESSAGE**

MSG TYPE : **DISTRESS ALERT**

NATURE : **UNDESIGNATED** ← Nature of Distress

LAT : **09° 12.1234N** ← Position of ship in distress (your ship) and time of distress position

LON/UTC : **123° 45.1234E / 12:34**

COMM MODE : **TELEPHONE / 8291.0kHz** ← Communication mode and communication frequency

DSC FREQ : **MULTI 2 4 6 8 12 16MHz** ← DSC frequency to send distress call

PRESS DISTRESS BUTTON  
TO SEND DISTRESS ALERT.

CANCEL : BACK

#### Individual TX call

SSB TX 2182.0/RX 2182.00 kHz

**COMPOSE MESSAGE**

MSG TYPE : **INDIVIDUAL MSG** ← Message type (Individual)

TO : **123456789** ← ID No. of station where message is to be sent

PRIORITY : **ROUTINE** ← Priority (Routine, Safety, Urgency)

COMM MODE : **TELEPHONE** ← Communication mode (Telephone, NBDP-ARQ, NBDP-FEC)

COMM FREQ : **2170.0kHz** ← Communication frequency

DSC FREQ : **2177.0kHz** ← DSC frequency

CANCEL : BACK      GO TO CALL

### 3. DSC OVERVIEW

This page is intentionally left blank.

# 4. DSC DISTRESS OPERATIONS

## Distress operation overview

1. Press the **DISTRESS** key.
2. Wait for the distress alert acknowledgment.
3. Communicate with the coast station.

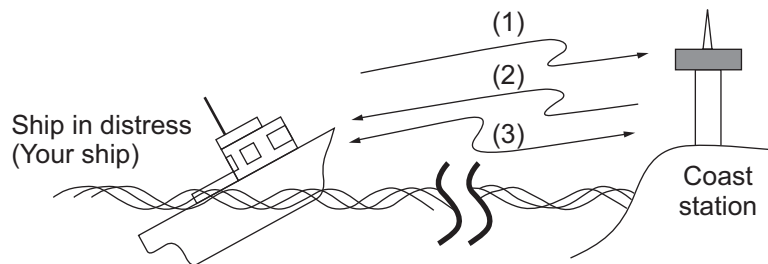

- (1) Ship in distress sends Distress Alert.
- (2) Coast station sends distress acknowledgment (DIST ACK).
- (3) Voice or telex communication between ship in distress and coast station.

## 4.1 How to Send Distress Alert

GMDSS ships carry a DSC terminal with which to transmit the distress alert in the event of a life-endangering situation. A coast station receives the distress alert and sends the distress alert acknowledge call to the ship in distress. Then, voice or telex communication between the ship in distress and coast station begins. Transmission of the distress alert and receiving of the distress alert acknowledgment are completely automatic - simply press the **DISTRESS** key to initiate the sequence.

There are three types of distress alerts; MULTI, SINGLE, AUTO. MULTI is used normally. To use another method, see step 10 in paragraph 4.1.2.

**Note:** After sending the distress alert, no control unit has priority.

### 4.1.1 How to send distress alert by **DISTRESS** key with distress information not edited

1. Open the **DISTRESS** key cover then press the **DISTRESS** key for four seconds.

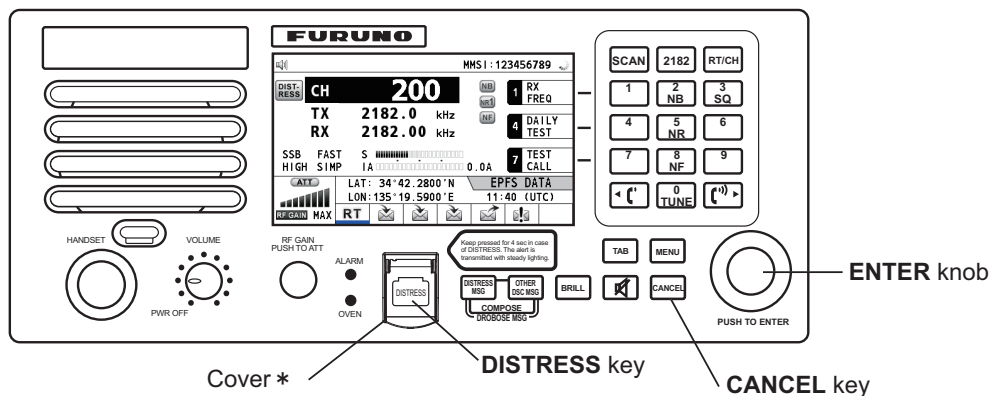

\*: The **DISTRESS** key is covered to prevent accidental operation.

#### 4. DSC DISTRESS OPERATIONS

The audio alarm sounds while pressing the key, and the key flashes in red. The countdown message appears on the screen while pressing the **DISTRESS** key (3S → 2S → 1S → 0S).

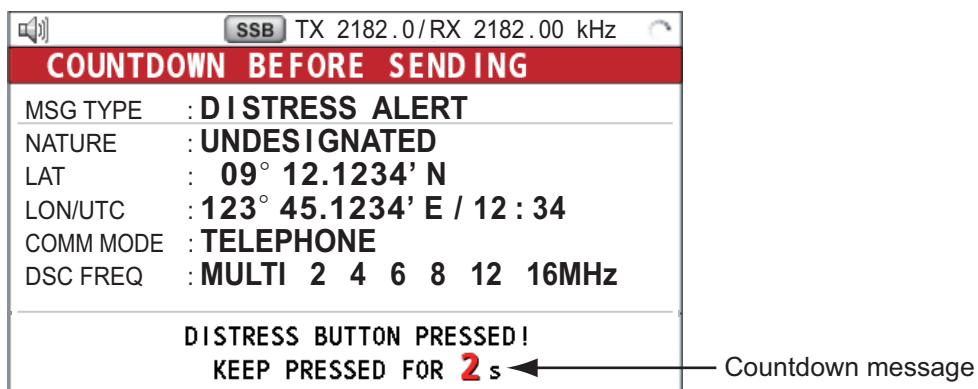

When the countdown shows 0S, the distress alert is sent. The audio alarm sounds for two seconds and the message "Sending DISTRESS ALERT." appears. The screen shows the contents of the distress alert call. The **DISTRESS** key lights in red and only the icon for DISTRESS transmission (📡!) is displayed in the tab area.

After the distress alert has been sent, the screen changes as below. Wait to receive the distress acknowledge call from a coast station. The elapsed time since transmission is displayed. At this time, the icons for other DSC received messages except the distress alert acknowledge call are not displayed. You can only confirm them in the log.

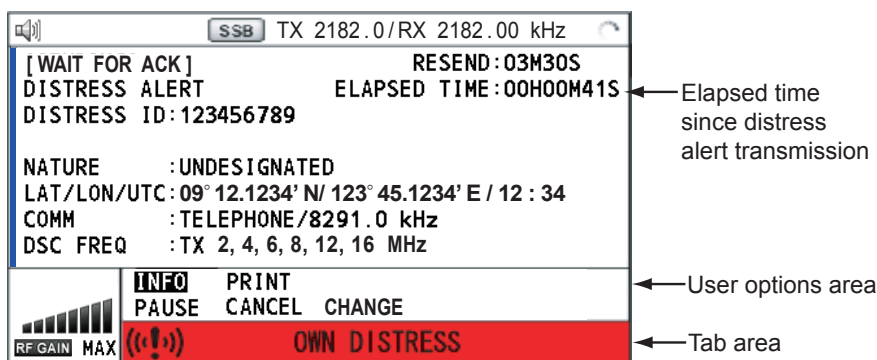

**Note:** If you do not receive the distress alert acknowledge call, the equipment automatically re-transmits the distress alert after 3 min 30 seconds to 4 min 30 seconds. Then awaits the distress alert acknowledge call. This is repeated until the distress alert is acknowledged.

You can temporarily stop the countdown for next retransmission by selecting [PAUSE] in the user options area. [PAUSE] indication changes to [START] and [PAUSE] is displayed instead of the countdown indication. To restart, select [START]. The countdown restarts and [START] indication in the user options area changes to [PAUSE].

Also, you can re-send the distress alert manually by pressing the **DISTRESS** key for four seconds.



When the distress acknowledge call is received, the audio alarm sounds, the LED flashes in red, and the icon for DISTRESS transmission (📡) appears. The screen changes as below.

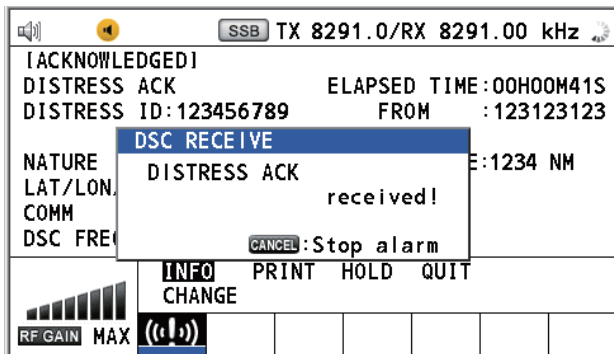

2. Press the **CANCEL** key to silence the audio alarm. Then, the LED stops flashing, and the pop-up message disappears.

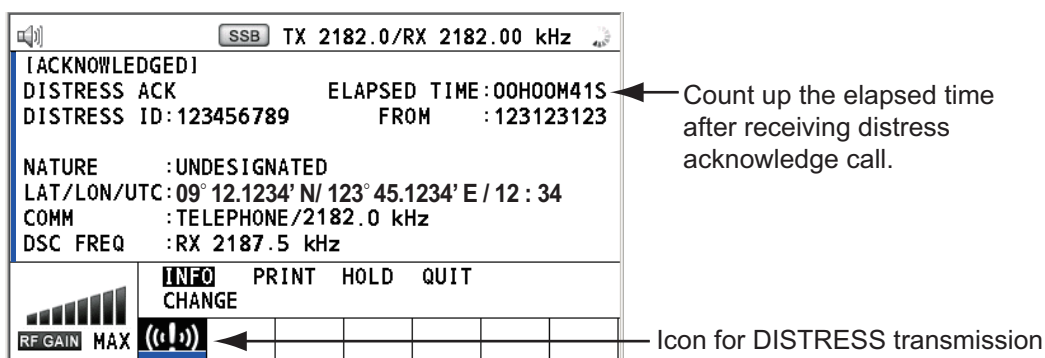

3. Communicate with the coast station via radiotelephone, following the instructions below. If the distress alert was sent using the MULTI mode, the radiotelephone automatically sets the working frequency on which the distress acknowledge call is first received.
  - a) Say “MAYDAY” three times.
  - b) Say “This is...” name of your ship and call sign three times.
  - c) Give nature of distress and assistance needed.
  - d) Give description of your ship (type, color, number of persons on board, etc.).

### 4.1.2 How to send distress alert by DISTRESS key with distress information edited

If you have a time to prepare the distress information, send the distress alert as follows:

1. Press the **DISTRESS MSG** key to display the following screen.

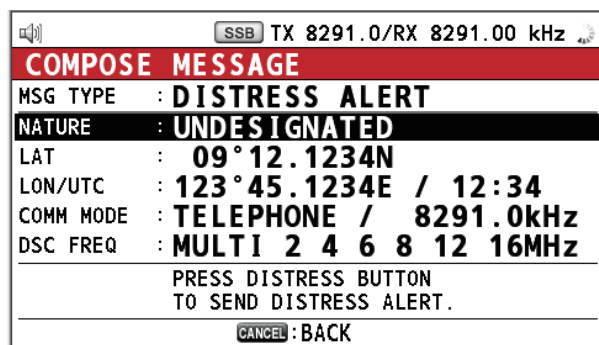

#### 4. DSC DISTRESS OPERATIONS

2. With [NATURE] selected, push the **ENTER** knob.
3. Rotate the **ENTER** knob to select nature of distress, among the following 11 selections, then push the knob.
  - UNDESIGNATED      • FIRE      • FLOODING
  - COLLISION      • GROUNDING      • LISTING
  - SINKING      • DISABLED&ADR(IFT)      • ABANDONING
  - PIRACY      • MAN OVERBOARD
4. With [LAT] and [LON/UTC] selected, push the **ENTER** knob.

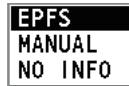

[EPFS]: The position information from EPFS is automatically shown.

[MANUAL]: Input your position manually.

[NO INFO]: No information.

5. Rotate the **ENTER** knob to select [EPFS], [MANUAL] or [NO INFO] then push the knob. For [MANUAL], go to step 6. For others, go to step 7.
6. Use the numeric keys to enter latitude, longitude and UTC time. (If necessary, switch coordinates: **1** key to switch to North (East for longitude); **2** key to switch to South (West for longitude).) Push the **ENTER** knob.

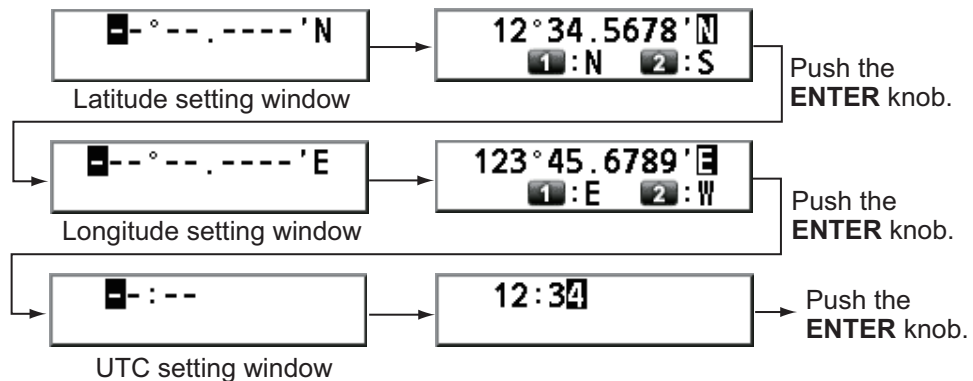

7. With [COMM MODE] selected, push the **ENTER** knob.
8. Rotate the **ENTER** knob to select [TELEPHONE] or [NBBDP-FEC] then push the knob.
9. With [DSC FREQ] selected, push the **ENTER** knob.

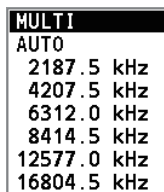

10. Rotate the **ENTER** knob to select the DSC frequency desired then push the knob. [MULTI]: Transmit the distress alert on three to six frequencies (in numerical order), which you can select among 2 MHz, 4 MHz, 6 MHz, 8 MHz, 12 MHz and 16 MHz. 2 MHz and 8 MHz are automatically selected and cannot be excluded.

Rotate the **ENTER** knob to select the desired frequency then push the knob. Each push of the **ENTER** knob displays (selected) or removes (deselected) the asterisk.

After setting, rotate the **ENTER** knob to select [EXIT] then push the knob.

* 2187.5kHz
* 8414.5kHz
-----
(*): 4207.5kHz
(*): 6312.0kHz
(*): 12577.0kHz
(*): 16804.5kHz
EXIT

[SINGLE]: You can transmit on the distress frequency of your selection. Select one frequency among 2 MHz, 4 MHz, 6 MHz, 8 MHz, 12 MHz and 16 MHz.  
 [AUTO]: Transmit the distress alert on 2 MHz at first (40 to 60 seconds). If the distress alert is not acknowledged, transmission occurs in this sequence:  
 2nd: 8 MHz, 3rd: 16 MHz, 4th: 4 MHz, 5th: 12 MHz and 6th: 6 MHz

11. Press the **DISTRESS** key for four seconds to send the distress alert. The audio alarm sounds while pressing the key, and the key flashes in red. The countdown message appears on the screen while pressing the **DISTRESS** key (3S → 2S → 1S → 0S) (refer to the illustration at step 1 in paragraph 4.1.1). When the countdown shows 0S, the distress alert is sent. The audio alarm sounds for two seconds and the message "Sending DISTRESS ALERT." appears.
12. When the distress acknowledge call is received, use the telephone or telex to communicate with the coast station. For NBDP, follow the procedure in "Communicating by NBDP terminal unit" on this page. For telephone, follow step 3 on paragraph 4.1.1. If you selected [MULTI] at step 10, you can communicate via telephone, on the communication frequency which the distress acknowledge call is received. If it is necessary to change the frequency, do the following:
  - 1) Rotate the **ENTER** knob to select [CHANGE] in the user options area then push the knob.

- 2) Rotate the **ENTER** knob to select the appropriate frequency then push the knob.

**Communication by NBDP terminal unit**

The following message appears on the NBDP's screen.

"DSC activates NBDP. To start call, select "DSCxx" in F3-1 Station Call. Press any key to escape."

1. Press any key on the NBDP terminal unit to erase the message.

#### 4. DSC DISTRESS OPERATIONS

2. Press the function key **F3** on the keyboard of the NBDP terminal unit to open the [Operate] menu.
3. Select [Call Station] then press the **Enter** key.

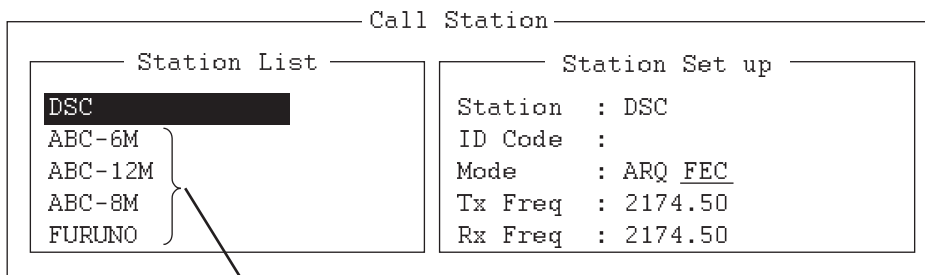

These items are not displayed when sending the distress alert.

4. With [DSC] selected, press the **Enter** key to connect the communication line. "Connect" appears in reverse video.
  5. Type and transmit your message, giving the following information:
    - Ship's name and call sign
    - Nature of distress and assistance needed
    - Description of your ship
  6. Press the function key **F10** to disconnect the line.
- For NBDP details, see chapters 7 through 10.

## 4.2 How to Receive a Distress Alert

When you receive a distress alert from a ship in distress, the audio alarm sounds and the LED flashes in red. The icon for DISTRESS receiving (🔊) appears in the tab area and the pop-up message "DISTRESS ALERT message received! [CANCEL]: Stop alarm" appears on the screen.

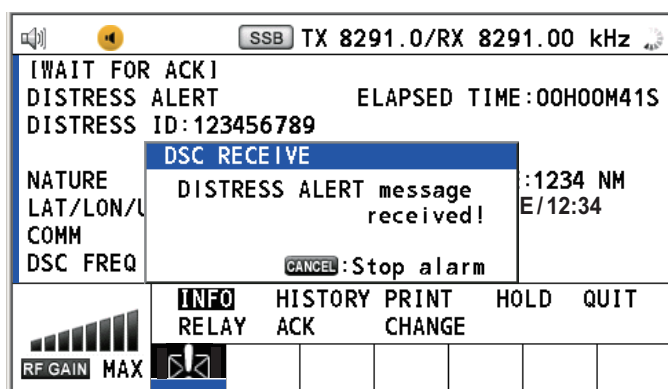

Press the **CANCEL** key to silence the audio alarm. Wait for the distress acknowledge call from a coast station. If you do not receive the distress acknowledge call from a coast station, which usually takes about five minutes from the time of receiving a distress alert, follow the flow charts in this section to determine your action.

**Note:** An asterisk (\*) appearing in a distress alert message indicates an error at the asterisk's location.

### 4.2.1 Distress alert received on MF band

Do the following:

- Continue watching on 2182 kHz. Wait for coast station to acknowledge the distress call. Watch until "SEELONCE FINI" is announced.
- If multiple DSC distress alerts are received from the same ship in distress and it is near your ship, communicate with RCC or coast station and send distress acknowledge call to the ship in distress under the direction of RCC or coast station.
- Watch on the distress frequency.

#### Action for ship receiving distress alert on MF band

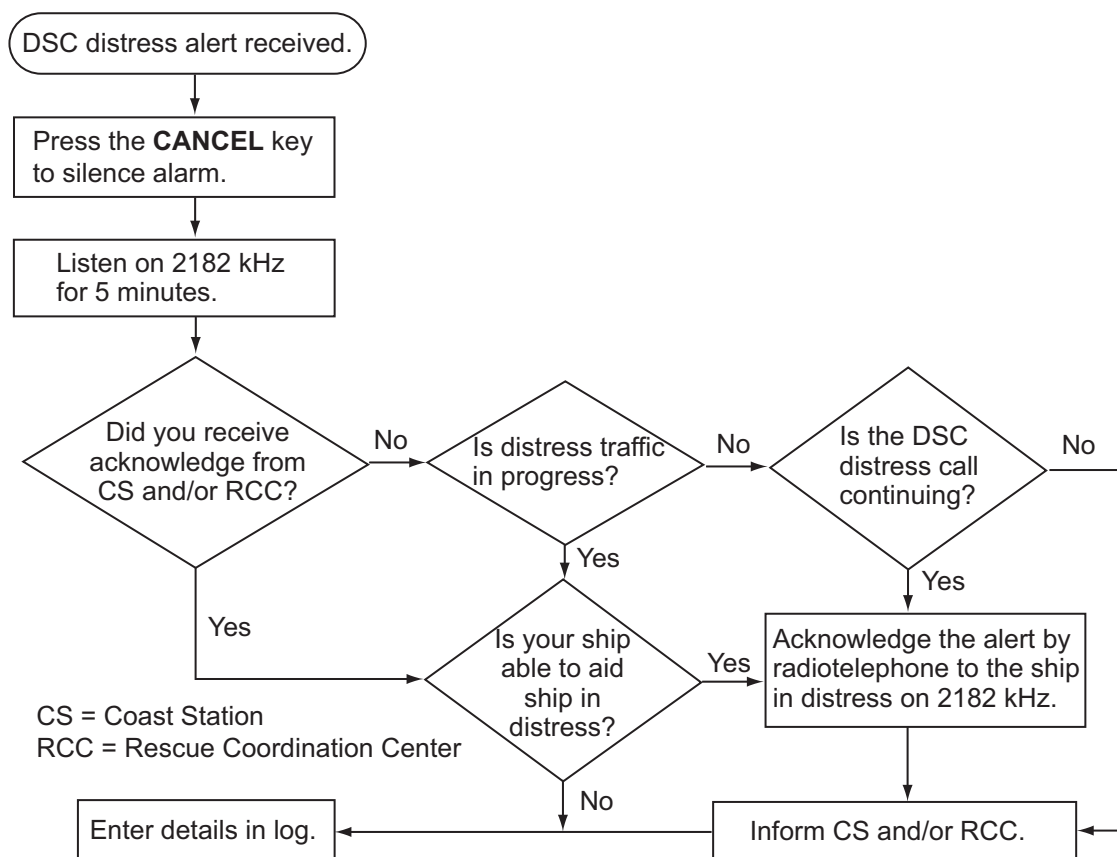

#### Send the distress acknowledge call to ship in distress (on MF band)

**Note:** You must wait at least five minutes before you can acknowledge a distress alert, to allow time for a coast station to transmit the distress acknowledge.

Transmit the distress acknowledge call to the ship in distress only when you do not receive it from a coast station and you are able to aid the ship in distress. First, contact the ship in distress over radiotelephone.

When you receive a distress alert from a ship in distress, the audio alarm sounds and the LED flashes in red. The icon for DISTRESS receiving appears in the tab area and the pop-up message "DISTRESS ALERT message received! [CANCEL]: Stop alarm" appears on the screen.

To terminate transmission of the distress alert, send acknowledge call as follows.

#### 4. DSC DISTRESS OPERATIONS

1. Press the **CANCEL** key to silence the audio alarm and stop the flashing of the LED.

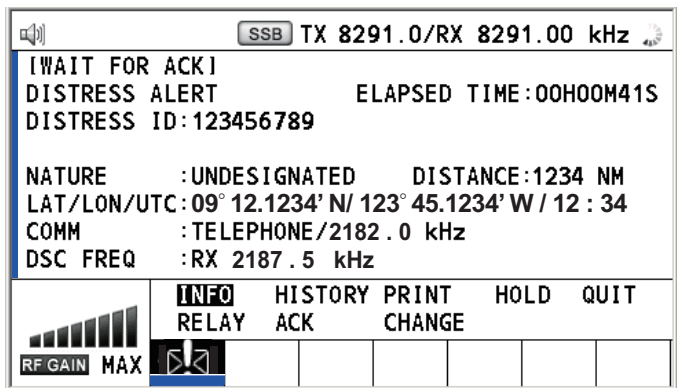

2. If you do not receive the distress acknowledge call from a coast station and you have received the distress alert more than twice, contact the ship in distress over radiotelephone.
3. Rotate the **ENTER** knob to select [ACK] in the user options area then push the knob. The following message appears on the screen.

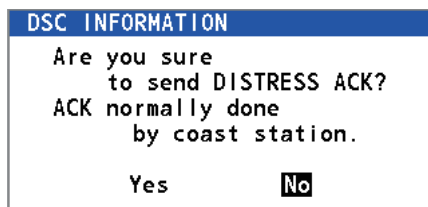

4. Rotate the **ENTER** knob to select [Yes] then push the knob to transmit the distress acknowledge call to the ship in distress. The screen changes as below.

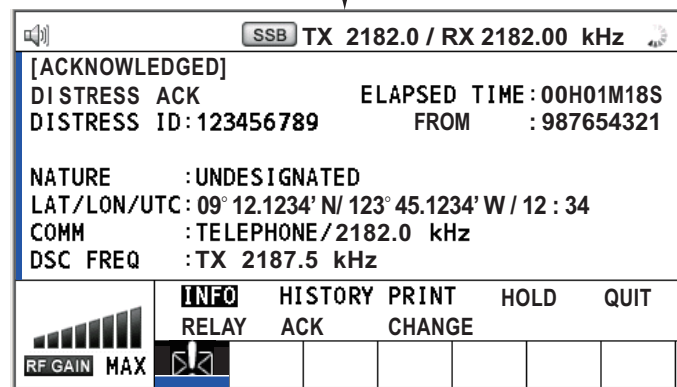
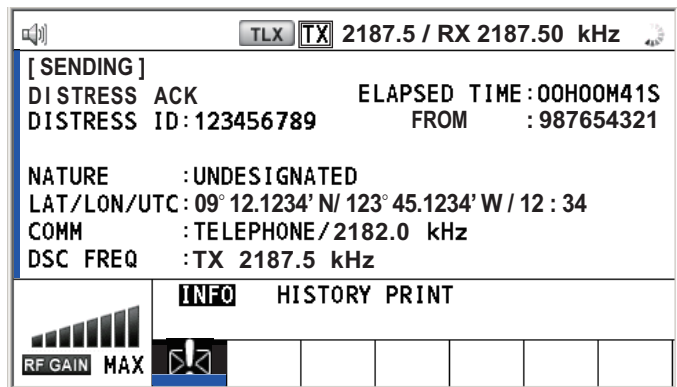

**Note:** You can not edit the message for the distress acknowledge call.

### 4.2.2 Distress alert received on HF band

If you receive a distress alert on the HF band, the audio alarm sounds and the LED flashes in red. The icon for DISTRESS receiving (  ) appears in the tab area and the pop-up message "DISTRESS ALERT message received! [CANCEL]: Stop alarm" appears on the screen. Press the **CANCEL** key to silence the audio alarm and stop the flashing of the LED. The screen for receiving the distress alert appears. Wait for the distress acknowledge call from a coast station. If you do not receive the distress acknowledge call from a coast station, which usually takes about five minutes from the time of receiving a distress alert, follow the flow chart in this section to determine your action.

- Watch on the distress frequency.
- Relay the distress alert in the following cases:
  - You have not received a distress acknowledge call from a coast station within five minutes after receiving a distress call.
  - You have not received a distress relay from other ship.
  - You cannot receive distress communications from other ship over radiotelephone.
  - The ship relaying the distress alert should establish communications with the station controlling the distress as directed and render such assistance as required and appropriate.
- If it is clear the ship or persons in distress are not near your ship and/or other vessels are better placed to assist, superfluous communications which could interfere with search and rescue activities should be avoided. Details should be recorded in the log.
- When the received distress frequency is different from the current communication frequency, do the following:
  1. Rotate the **ENTER** knob to select [CHANGE] then push the knob.
  2. Rotate the **ENTER** knob to select the frequency same as the received distress one then push the knob.

**Action for ship receiving distress alert on HF band**

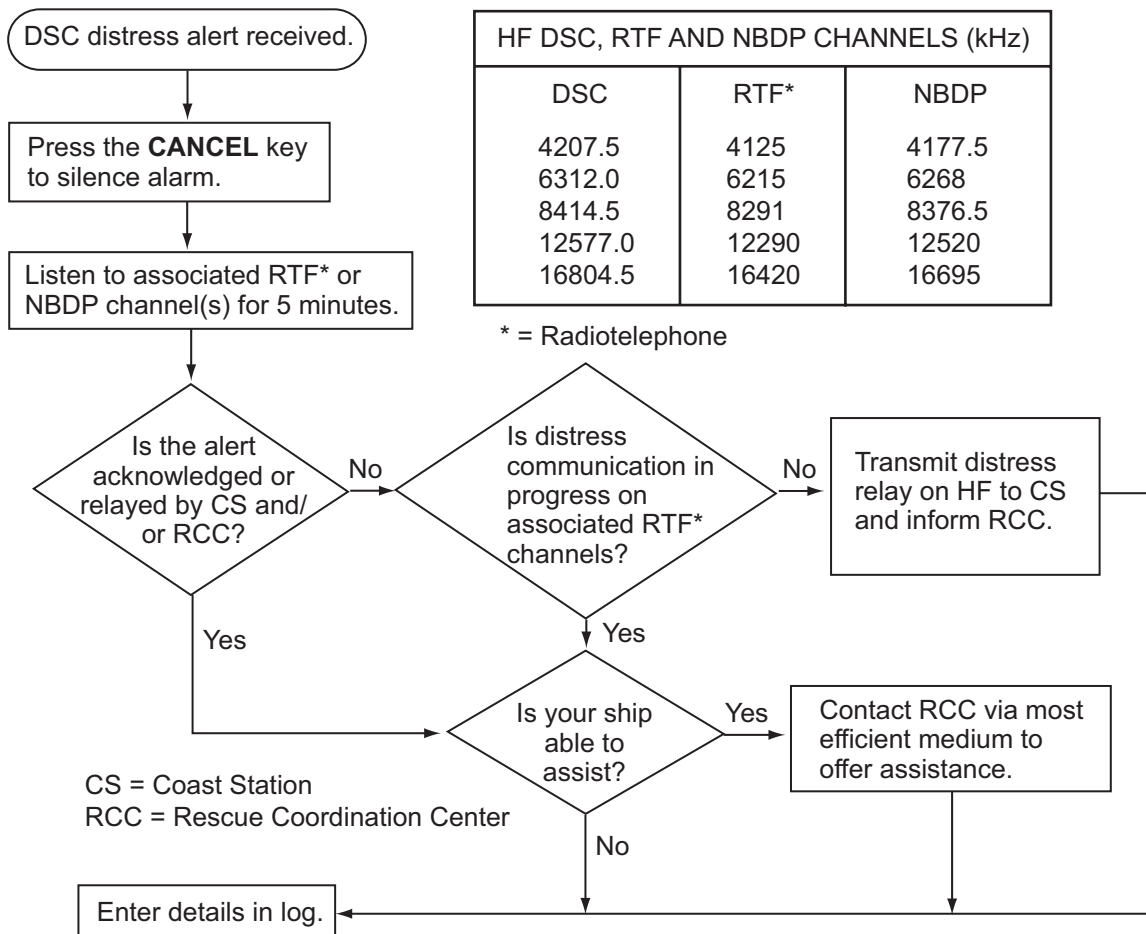

**Send the distress relay to coast station (on HF band)**

When you receive a distress alert from a ship in distress, the audio alarm sounds and the LED flashes in red. The icon for DISTRESS receiving (📞) appears in the tab area and the pop-up message appears on the screen.

1. Press the **CANCEL** key to silence the audio alarm and stop the flashing of the LED.
2. Rotate the **ENTER** knob to select [RELAY] in the user options area then push the knob.





If three minutes have not passed after receiving the distress alert from the ship in distress, the following message appears on the screen. If you are sure to acknowledge the distress call, rotate the **ENTER** knob to select [Yes] then push the knob to erase the pop-up message and show the window at the previous page.

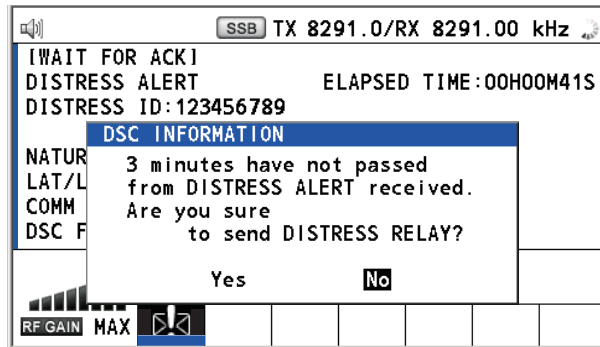

3. Rotate the **ENTER** knob to select [TO] then push the knob.
4. Rotate the **ENTER** knob to select [DIRECT INPUT] or [ADDRESS BOOK DATA] then push the knob.  
 [ADDRESS BOOK DATA]: Select an MMSI from the [ADDRESS BOOK] (see section 6.15) then push the **ENTER** knob.  
 [DIRECT INPUT]: Enter the MMSI of the coast station, where to send the distress relay, with the numeric keys then push the **ENTER** knob.
5. With [DSC FREQ] selected, push the **ENTER** knob.
6. Rotate the **ENTER** knob to select a frequency then push the knob. You should first select [8414.5 kHz].
7. With [GO TO CALL] selected, push the **ENTER** knob. The screen changes to the one for transmitting. After transmitting, the WAIT FOR ACK screen appears.

When you receive the distress relay individual acknowledgment from the coast station, the audio alarm sounds and a pop-up message appears. Press the **CANCEL** key to silence the alarm and erase the pop-up message. Communicate with the coast station by telephone, over the frequency specified. If you do not receive the distress acknowledgment from a coast station, select [RELAY] then push the **ENTER** knob to transmit the distress relay again, over a different frequency.

## 4.3 How to Send Distress Relay on Behalf of a Ship in Distress

### 4.3.1 How to send distress relay to coast station

You can send the distress relay to a coast station on behalf of a ship in distress in the following cases:

- You are near the ship in distress and the ship in distress cannot transmit the distress alert.
- When the master or person responsible for your ship considers that further assistance is necessary.

**Note:** Do not use the **DISTRESS** key to relay distress.

#### 4. DSC DISTRESS OPERATIONS

1. Press the **DISTRESS MSG** key and the **OTHER DSC MSG** key simultaneously to open the composing screen for the distress relay individual.

SSB TX 2182.0/RX 2182.00 kHz

**COMPOSE MESSAGE**

MSG TYPE : **RELAY INDIVIDUAL**

TO : -----

DISTRESS ID: **NO INFO**

NATURE : **UNDESIGNATED**

LAT : **NO INFO**

LON/UTC : **NO INFO / NO INFO**

COMM : **TELEPHONE / 2182.0kHz**

DSC FREQ : **2187.5kHz**

CANCEL:BACK GO TO CALL

2. With [TO] selected, push the **ENTER** knob.
3. Rotate the **ENTER** knob to select [DIRECT INPUT] or [ADDRESS BOOK DATA] then push the knob.  
[ADDRESS BOOK DATA]: Select an MMSI from the [ADDRESS BOOK] (see section 6.15) then push the **ENTER** knob.  
[DIRECT INPUT]: Enter the MMSI of the coast station, where to send the distress relay, with the numeric keys then push the **ENTER** knob.
4. With [DISTRESS ID] selected, push the **ENTER** knob.

DIRECT INPUT  
NO INFO

5. Rotate the **ENTER** knob to select [DIRECT INPUT] or [NO INFO] then push the knob. For [DIRECT INPUT], go to step 6. For [NO INFO], go to step 7.
6. Enter the ID (MMSI) of the ship in distress with the numeric keys then push the **ENTER** knob.
7. With [NATURE] selected, push the **ENTER** knob.
8. Rotate the **ENTER** knob to select nature of distress then push the knob.
9. With [LAT] and [LON/UTC] selected, push the **ENTER** knob.

EPFS  
MANUAL  
NO INFO

10. Rotate the **ENTER** knob to select [EPFS], [MANUAL] or [NO INFO] then push the knob. For [MANUAL], go to step 11. For others, go to step 12.
11. Use the numeric keys to enter latitude and longitude of the ship in distress. (If necessary, switch coordinates: **1** key to switch to North (East for longitude); **2** key to switch to South (West for longitude).) Push the **ENTER** knob. Also, enter the UTC time then push the **ENTER** knob.
12. With [COMM] selected, push the **ENTER** knob.
13. Rotate the **ENTER** knob to select [TELEPHONE] or [NBDP-FEC] then push the knob.
14. With [DSC FREQ] selected, push the **ENTER** knob.
15. Rotate the **ENTER** knob to select the frequency then push the knob.

16. With [GO TO CALL] selected, push the **ENTER** knob. The distress relay is transmitted to the coast station. After transmitting, the WAIT FOR ACK screen appears. The elapsed time since transmitting is displayed.

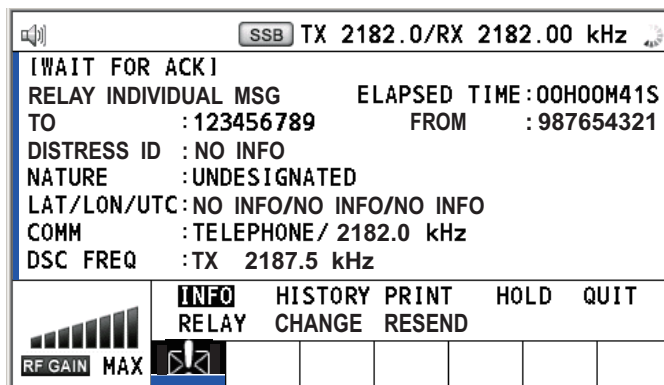

When you receive the distress relay individual acknowledgment from the coast station, the audio alarm sounds and the pop-up message "RELAY INDIVIDUAL ACK received! [CANCEL]: Stop alarm" appears. Press the **CANCEL** key to silence the alarm and erase the pop-up message. Communicate with the coast station by telephone, over the frequency specified. To close the distress receiving session, select [QUIT] in the user options area then push the **ENTER** knob.

### 4.3.2 How to send distress relay to ships in your area

If a coast station directs you to send a distress relay to ships in your area, follow the procedure below. Do not transmit a distress relay unless directed to do so by a coast station.

1. Press the **DISTRESS MSG** key and the **OTHER DSC MSG** key simultaneously to open the screen for composing the distress relay individual.

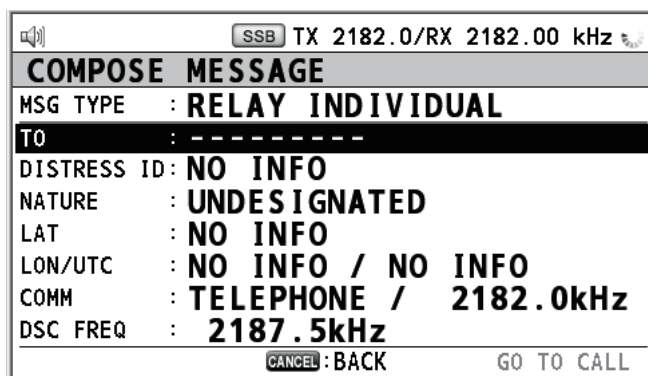

2. Rotate the **ENTER** knob to select [MSG TYPE] then push the knob.
3. Rotate the **ENTER** knob to select [RELAY AREA] then push the knob. The following message appears on the screen.

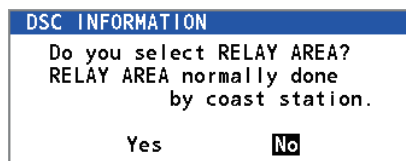

4. Rotate the **ENTER** knob to select [Yes] then push the knob.
5. With [AREA CR] selected, push the **ENTER** knob.



#### 4. DSC DISTRESS OPERATIONS

6. Rotate the **ENTER** knob to select [CIRCLE] or [QUADRANT] then push the knob.
7. Set the area with the numeric keys (see step 5 in paragraph 5.3.1). The geographical area call is for sending a call to all ships within the area you designated. In the figure below, for example, the call will be sent to all ships within 24-34°N, 135-140°W (QUADRANT (LL)) and 34°N, 140°W, range: 500 NM (CIRCLE).

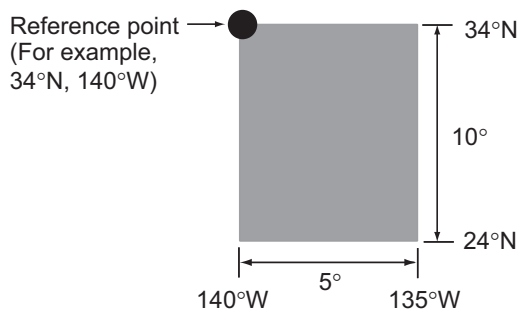

QUADRANT (LL)

34°N, 140°W, +10° → 5°

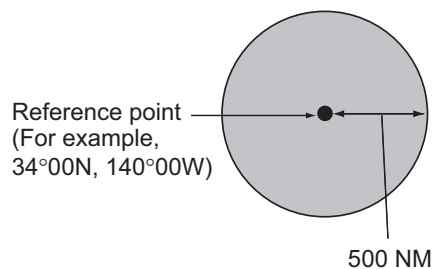

CIRCLE

34°00N, 140°00W, 0500NM

8. With [DISTRESS ID] selected, push the **ENTER** knob.
9. Rotate the **ENTER** knob to select [DIRECT INPUT] or [NO INFO] then push the knob. For [DIRECT INPUT], go to step 10. For [NO INFO], go to step 11.
10. Enter the ID (MMSI) of the ship in distress with the numeric keys then push the **ENTER** knob.
11. With [NATURE] selected, push the **ENTER** knob.
12. Rotate the **ENTER** knob to select nature of distress then push the knob.
13. With [LAT] and [LON/UTC] selected, push the **ENTER** knob.
14. Rotate the **ENTER** knob to select [EPFS], [MANUAL] or [NO INFO] then push the knob. For [MANUAL], go to step 15. For others, go to step 16.
15. Use the numeric keys to enter latitude and longitude of the ship in distress. (If necessary, switch coordinates: **1** key to switch to North (East for longitude); **2** key to switch to South (West for longitude).) Push the **ENTER** knob. Also, enter the UTC time then push the **ENTER** knob.
16. With [COMM] selected, push the **ENTER** knob.
17. Rotate the **ENTER** knob to select [TELEPHONE] or [NBDP-FEC] then push the knob.
18. With [DSC FREQ] selected, push the **ENTER** knob.
19. Rotate the **ENTER** knob to select the frequency then push the knob.
20. With [GO TO CALL] selected, push the **ENTER** knob. The distress relay is transmitted to the ships within the area specified at step 7.

## 4.4 How to Receive Distress Relay from Coast Station

Your ship receives the distress relay when:

- The coast station sends the distress relay to your ship (DISTRESS RELAY INDIVIDUAL).
- The coast station sends the distress relay to the area where you are navigating (DISTRESS RELAY AREA).

When you receive a distress relay message from a coast station, continue monitoring distress and safety frequencies. The audio alarm sounds and the LED flashes in red.

The icon (📢) appears in the tab area and the pop-up message appears on the screen.

1. Press the **CANCEL** key to silence the audio alarm, stop the flashing of the LED and erase the pop-up message.
2. Watch distress/safety frequency.

If you receive a DISTRESS RELAY INDIVIDUAL call with the different frequency from the transceiver unit, for example, the following message appears on the screen.

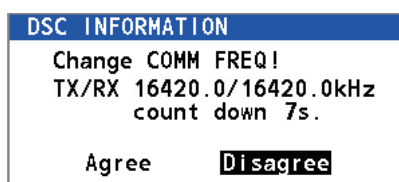

Rotate the **ENTER** knob to select [Agree] then push the knob. The radiotelephone automatically sets working frequency.

If you change the communication frequency, do the following:

1. Rotate the **ENTER** knob to select [CHANGE] in the user options area then push the knob.
2. Rotate the **ENTER** knob to select working frequency then push the knob.

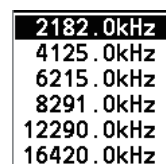

## 4.5 How to Cancel Distress Alert

You can cancel the distress alert while it is being sent or while waiting for its acknowledgment as follows.

1. Rotate the **ENTER** knob to select [CANCEL] in the user options area then push the knob. The following message appears on the screen.

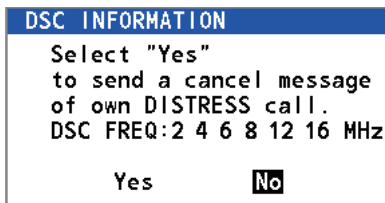

2. Rotate the **ENTER** knob to select [Yes] then push the knob to cancel the distress alert. The screen changes as below.

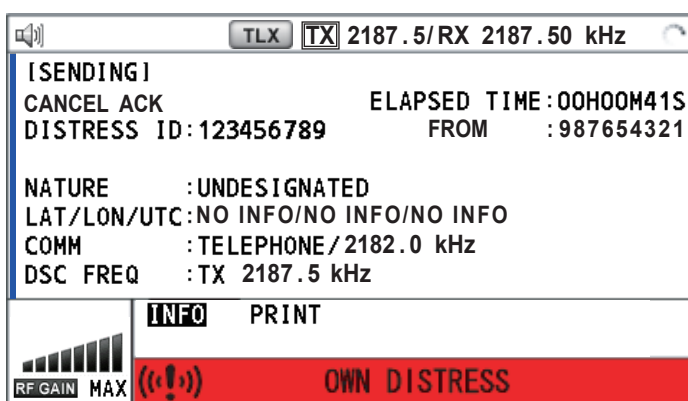

After transmitting the distress cancel call, the following message appears on the screen.

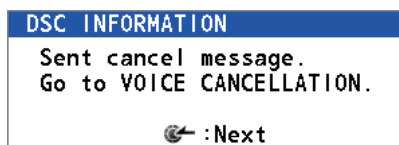

3. Push the **ENTER** knob to erase the message. The screen for the selection of frequency appears.

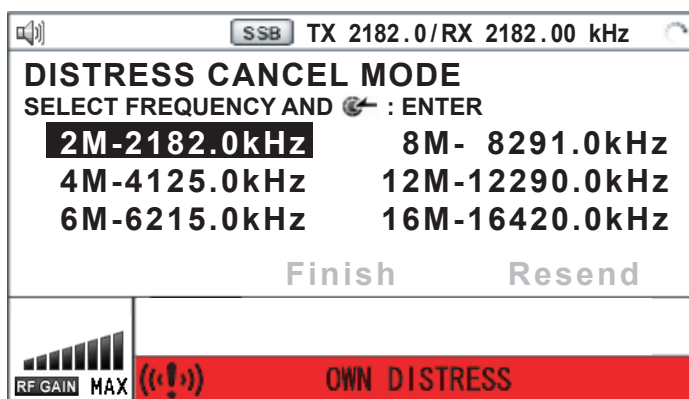

4. Rotate the **ENTER** knob to select a frequency then push the knob. The following message appears on the screen.

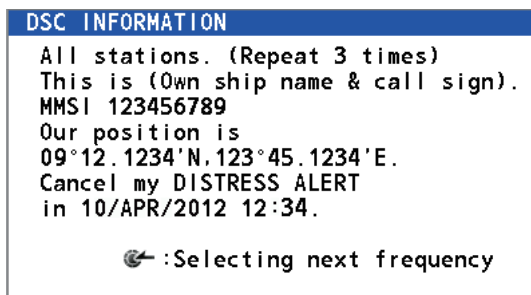

5. Communicate with all ships via radiotelephone referring to the message at step 4.
6. Push the **ENTER** knob. The screen for the selection of frequency appears again. The frequency marked by asterisk shows that the call cancellation by voice was completed for that frequency.

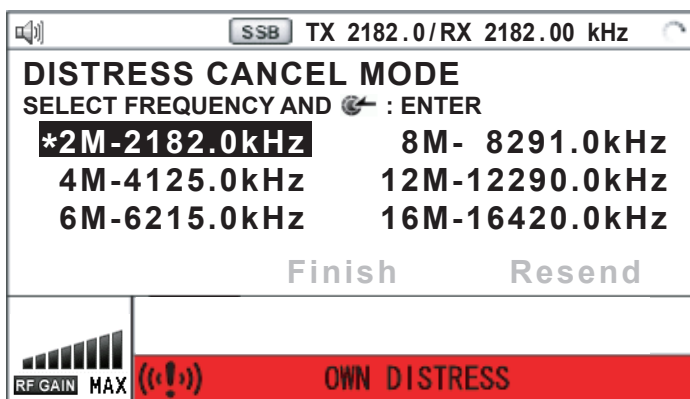

7. Repeat steps 4 through 6 to cancel for ALL frequencies. When cancellation on all frequencies is completed, the options [Finish] and [Resend] appear.

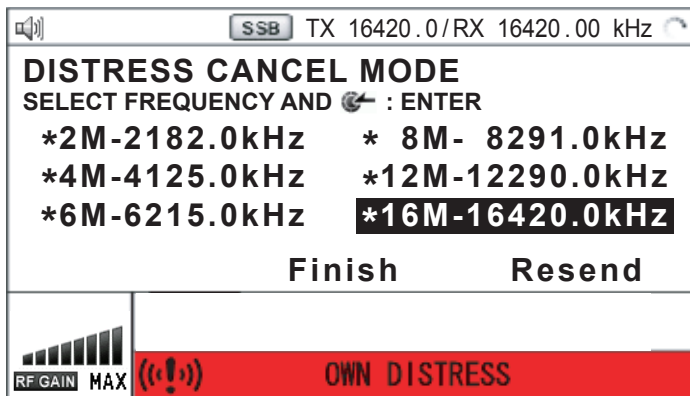

8. Rotate the **ENTER** knob to select [Finish] then push the knob.

#### 4. DSC DISTRESS OPERATIONS

This page is intentionally left blank.



# 5. DSC GENERAL MESSAGE CALLING, RECEIVING

## General procedure for non-distress DSC messages

The procedure for sending and receiving non-distress DSC messages is similar among message types. The following is an example of the sequence for an individual call.

1. Send the individual message.
2. Wait for the individual message acknowledgment.
3. Start the communication.

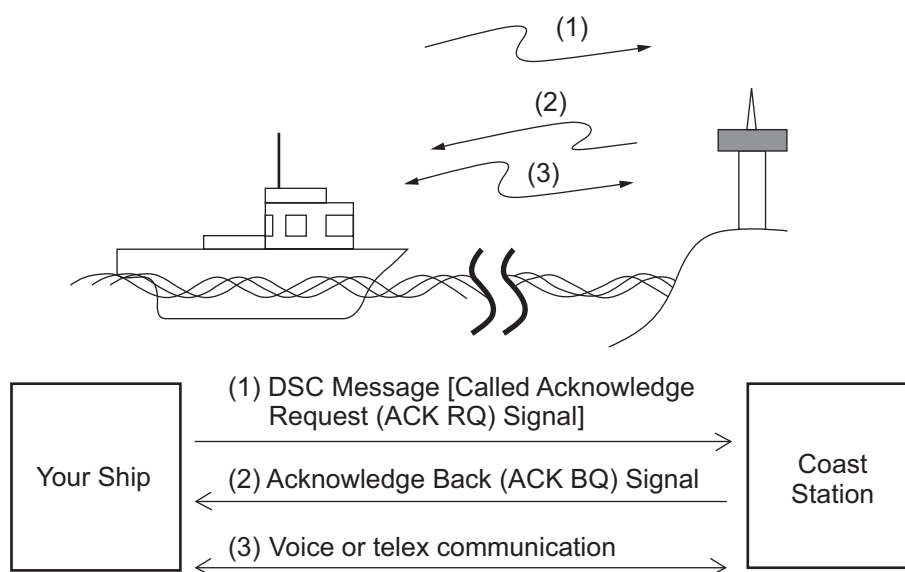

**Note:** This unit has a BUSY CHECK feature. The BUSY CHECK feature monitors the DSC message frequency prior to sending the message. If the frequency is already under use, the DSC message is stopped prior to sending. When the message is stopped, the pop-up message shown in the figure below is displayed. In this state, message transmission is not possible.

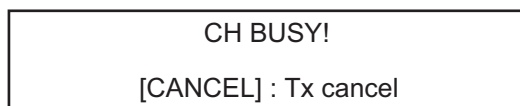

- When the frequency under use is free, the pop-up message disappears then the DSC message is sent.
- Press the **CANCEL** key to cancel sending the message. The pop-up message disappears.
- If the pop-up message is not closed within five minutes, the message transmission is automatically canceled and the pop-up message disappears.

## 5.1 Individual Call

The individual call is for calling a specific station. After sending an individual call, called ACK RQ transmission, wait to receive the acknowledge back (ACK BQ) signal from the receiving station.

### 5.1.1 How to send an individual call

1. Press the **OTHER DSC MSG** key.

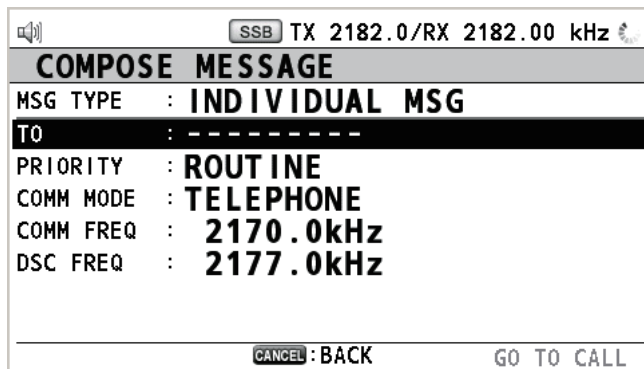

2. Rotate the **ENTER** knob to select [MSG TYPE] then push the knob.



3. Rotate the **ENTER** knob to select [INDIVIDUAL MSG] then push the knob.
4. With [TO] selected, push the **ENTER** knob.

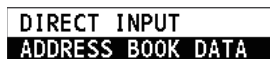

5. Rotate the **ENTER** knob to select [DIRECT INPUT] or [ADDRESS BOOK DATA] then push the knob.  
 [ADDRESS BOOK DATA]: Select an MMSI from the [ADDRESS BOOK] (see section 6.15) then push the **ENTER** knob.  
 [DIRECT INPUT]: Enter the MMSI of the station where to send the call then push the **ENTER** knob.
6. Rotate the **ENTER** knob to select [PRIORITY] then push the knob.



7. Rotate the **ENTER** knob to select [ROUTINE], [SAFETY] or [URGENCY] then push the knob.
8. With [COMM MODE] selected, push the **ENTER** knob.



9. Rotate the **ENTER** knob to select communication mode then push the knob.  
**Note:** NBDP terminal unit is required for [NBDP-ARQ] and [NBDP-FEC].

10. Follow "How to set DSC frequency" to set DSC frequency.

### How to set DSC frequency

The [COMM FREQ] is automatically set to the same pair frequency as the DSC frequency. If you change the communication frequency, set the [DSC FREQ] before setting the [COMM FREQ].

#### Routine priority

- 1) Rotate the **ENTER** knob to select [DSC FREQ] then push the knob.

2MHz
4MHz
6MHz
8MHz
12MHz
16MHz
18MHz
22MHz
25MHz

- 2) Rotate the **ENTER** knob to select DSC band then push the knob. One of the menus shown below appears depending on the band selected.

2MHz: To the ship station

INTL :T 2177.0/R 2177.0

2MHz: To the coast station

INTL :T 2189.5/R 2177.0

8MHz

INTL :T 8415.0/R 8436.5

LOCAL1 :T 8415.5/R 8437.0

LOCAL2 :T 8416.0/R 8437.5

18MHz

INTL :T18898.5/R19703.5

LOCAL1 :T18899.0/R19704.0

LOCAL2 :T18899.5/R19704.5

4MHz

INTL :T 4208.0/R 4219.5

LOCAL1 :T 4208.5/R 4220.0

LOCAL2 :T 4209.0/R 4220.5

12MHz

INTL :T12577.5/R12657.0

LOCAL1 :T12578.0/R12657.5

LOCAL2 :T12578.5/R12658.0

22MHz

INTL :T22374.5/R22444.0

LOCAL1 :T22375.0/R22444.5

LOCAL2 :T22375.5/R22445.0

6MHz

INTL :T 6312.5/R 6331.0

LOCAL1 :T 6313.0/R 6331.5

LOCAL2 :T 6313.5/R 6332.0

16MHz

INTL :T16805.0/R16903.0

LOCAL1 :T16805.5/R16903.5

LOCAL2 :T16806.0/R16904.0

25MHz

INTL :T25208.5/R26121.0

LOCAL1 :T25209.0/R26121.5

LOCAL2 :T25209.5/R26122.0

- 3) Rotate the **ENTER** knob to select DSC frequency then push the knob. The screen shows the DSC frequency band selected, at [DSC FREQ].

#### Urgency or safety priority

- 1) Rotate the **ENTER** knob to select [DSC FREQ] then push the knob.

2187.5kHz
4207.5kHz
6312.0kHz
8414.5kHz
12577.0kHz
16804.5kHz

- 2) Rotate the **ENTER** knob to select the frequency then push the knob.

If you change the communication frequency, go to step 11. If not, go to step 13.

11. Rotate the **ENTER** knob to select [COMM FREQ] then push the knob.

FREQUENCY
CHANNEL

**Note:** When you send an individual call to a coast station, [COMM FREQ] is automatically set to [POSITION] or [NO INFO]. [NO INFO] lets the receiving station set the working frequency.

5. DSC GENERAL MESSAGE CALLING, RECEIVING

12. Follow "How to set working channel, frequency" to set working channel or frequency.

**How to set working channel, frequency**

To send a call and communicate with the receiving station, set the working frequency as below. The working frequency can be entered by TX and RX frequencies or channel number.

- 1) Rotate the **ENTER** knob to select [FREQUENCY] or [CHANNEL] then push the knob.



- 2) Enter TX/RX frequency or channel with the numeric keys then push the **ENTER** knob.
13. Rotate the **ENTER** knob to select [GO TO CALL] then push the knob to send the individual call. The screen changes as below.

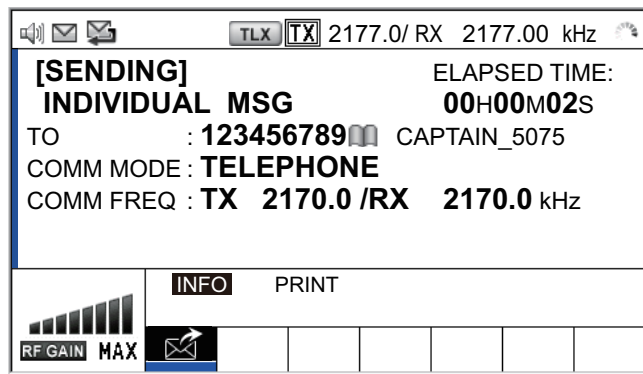

The timer starts counting up the time since the call was sent. After the call is sent, the equipment waits for acknowledgment of the call, showing the WAIT FOR ACK screen as below.



When the ACK is received, the audio alarm sounds and the pop-up message "ROUTINE (or SAFETY, URGENCY) INDIVIDUAL ACK received! [CANCEL]:"

"Stop alarm" appears on the screen as below. The timer starts counting up the time since the ACK was received.

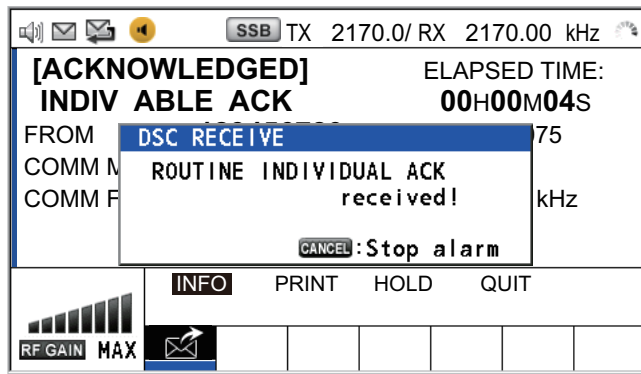

There are three types of ACK messages; [ABLE ACK], [UNABLE ACK] and [ABLE CHANGE FREQ].

14. Do one of the following depending on the message type shown at step 13.

#### **Able acknowledge call received**

- 1) Press the **CANCEL** key to silence the audio alarm and erase the pop-up message.
- 2) The working frequency is automatically set; you can communicate by radio-telephone or NBDP (see the following "How to send message by NBDP terminal unit").
- 3) After you have completed communications, rotate the **ENTER** knob to select [QUIT] in the user options area then push the knob.

#### **How to send message by NBDP terminal unit**

The following message appears on the NBDP's screen.

"DSC activates NBDP. To start call, select "DSCxx" in F3-1 Station Call. Press any key to escape."

- 1) Press any key on the NBDP terminal unit to erase the message.
- 2) Press the function key **F3** on the keyboard of the NBDP terminal unit to open the [Operate] menu.
- 3) Select [Call Station] then press the **Enter** key.
- 4) With [DSC] selected; press the **Enter** key. "Connect" appears in reverse video.
- 5) Type and transmit your message.
- 6) After you send the message, press the function key **F10** to disconnect the line.

**Able to change frequency acknowledge call received**

This call means that the station you sent the individual call to accepts your call with the frequency or communication mode that the station requires.

- 1) Press the **CANCEL** key to silence the audio alarm and erase the pop-up message. The following message appears on the screen.

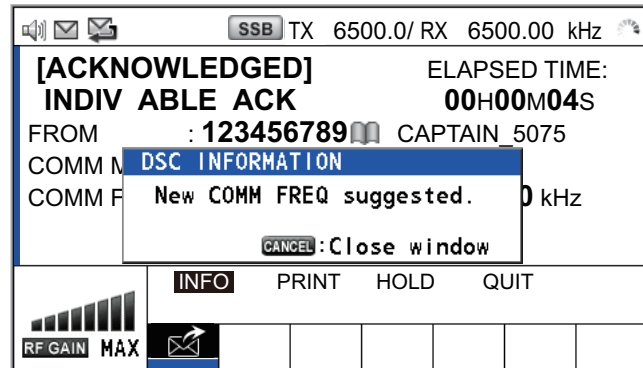

- 2) Press the **CANCEL** key to erase the message. The working frequency is changed to one that the station requires. You can communicate by radiotelephone or NBDP, whichever the station requires.
- 3) After you have completed communications, rotate the **ENTER** knob to select [QUIT] in the user options area then push the knob.

**Unable acknowledge call received**

- 1) Press the **CANCEL** key to silence the audio alarm and erase the pop-up message. The reason for [UNABLE ACK] is displayed on the screen.

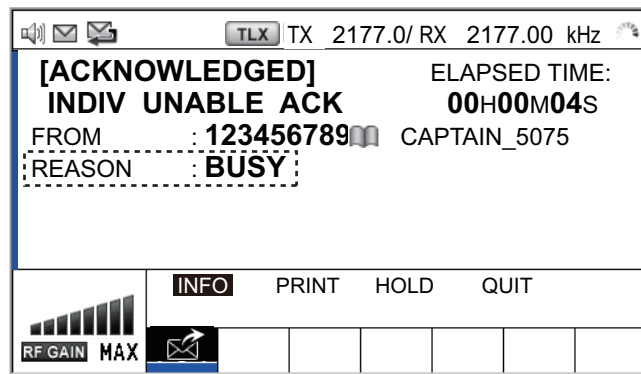

*Reason for unable to acknowledge*

• NO REASON	• CAN'T USE CH
• BUSY	• CAN'T USE MODE
• EQUIP ERROR	• CONGESTION AT CENTER*
• QUEUE INDICATION	• OPERATOR ABSENT
• STATION BARRED	• TEMP. UNAVAILABLE

\*: Coast station use

- 2) Rotate the **ENTER** knob to select [QUIT] in the user options area then push the knob.  
**Note:** If the coast station sends the message "QUEUE INDICATION", wait until your turn comes.

If there is no response from the receiving station, do one of the following procedures:

- **Resend call:** Rotate the **ENTER** knob to select [RESEND] in the user options area then push the knob.
- **Cancel call:** Rotate the **ENTER** knob to select [QUIT] in the user options area then push the knob. The following message appears.

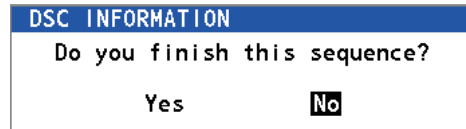

Rotate the **ENTER** knob to select [Yes] then push the knob.

### 5.1.2 How to receive an individual call

Unable acknowledge is sent automatically or manually depending on the acknowledgment method setting (see section 6.17). Able acknowledge is sent only manually.

**Note:** The handset must be on hook and all sessions must be quit to enable automatic acknowledge.

#### Send unable acknowledge automatically

If the frequency or mode specified by the sending station is one that you cannot use, an unable acknowledge [CAN'T USE CH] is sent automatically. The [ACK SETTINGS] menu is set to [AUTO (UNABLE)]. It takes about seven seconds to transmit the call.

#### Send able/unable acknowledge manually

When an individual call is received with the setting [MANUAL] on the [ACK SETTINGS] menu, the audio alarm sounds and a pop-up message appears on the screen as below.

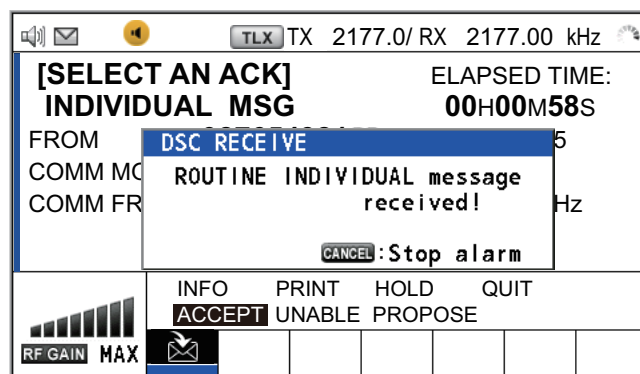

Press the **CANCEL** key to silence the audio alarm and erase the pop-up message. There are three types of ACK transmission; able acknowledge, able to change frequency and unable acknowledge. Follow the appropriate procedure on this and the next page.

5. DSC GENERAL MESSAGE CALLING, RECEIVING

• **How to send able acknowledge call**

1. With [ACCEPT] selected, push the **ENTER** knob to send the able acknowledge call.

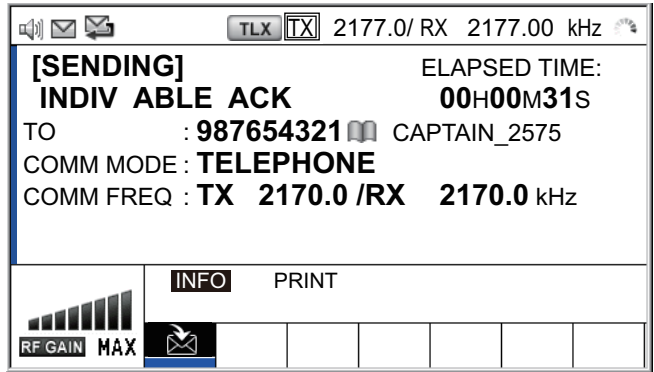

2. Communicate by radiotelephone or NBDP (see "Communication by NBDP terminal unit" on page 5-9).
3. After you have completed communications, rotate the **ENTER** knob to select [QUIT] in the user options area then push the knob.

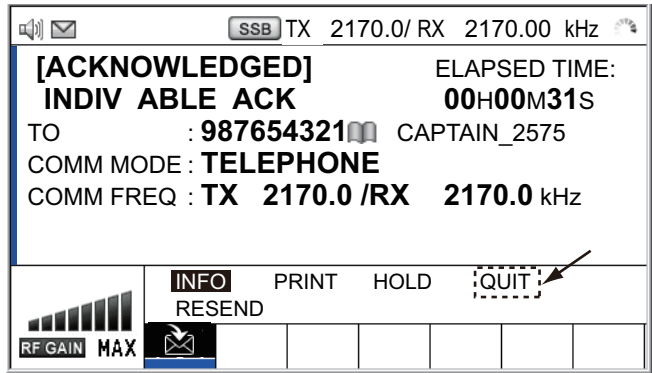

• **How to send unable acknowledge call**

1. Rotate the **ENTER** knob to select [UNABLE] in the user options area then push the knob.

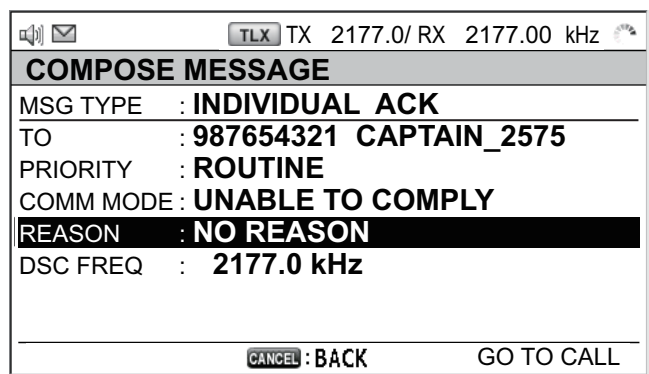



2. With [REASON] selected, push the **ENTER** knob.

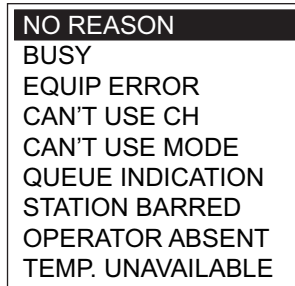

3. Rotate the **ENTER** knob to select the reason for unable then push the knob.
4. With [GO TO CALL] selected, push the **ENTER** knob to send unable acknowledge call.

- **How to send able acknowledge call and change frequency**

1. Rotate the **ENTER** knob to select [PROPOSE] in the user options area then push the knob.

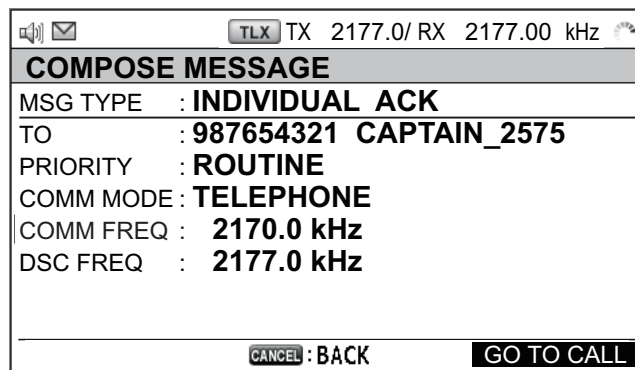

2. Rotate the **ENTER** knob to select [COMM MODE] then push the knob.
3. Rotate the **ENTER** knob to select [TELEPHONE], [NBDP-ARQ] or [NBDP-FEC] then push the knob.
4. With [COMM FREQ] selected, push the **ENTER** knob.
5. Rotate the **ENTER** knob to select [FREQUENCY] or [CHANNEL] then push the knob.
6. Referring to "How to set working channel, frequency" on page 5-4, set the frequency or channel.
7. With [GO TO CALL] selected, push the **ENTER** knob to send the able to change frequency acknowledge call.
8. Communicate by radiotelephone or NBDP (see the following "Communication by NBDP terminal unit").
9. After you have completed communications, rotate the **ENTER** knob to select [QUIT] in the user options area then push the knob.

### Communication by NBDP terminal unit

After acknowledging an individual call, do the following to communicate by NBDP terminal unit. The message from the other party appears on your NBDP terminal unit.

1. After receiving the message from the other party, type your message and transmit it.
2. Press the function key **F10** to disconnect the line.

## 5.2 Group Call

A group call is for calling a specific group by specifying its group MMSI.

### 5.2.1 How to send a group call

1. Press the **OTHER DSC MSG** key.

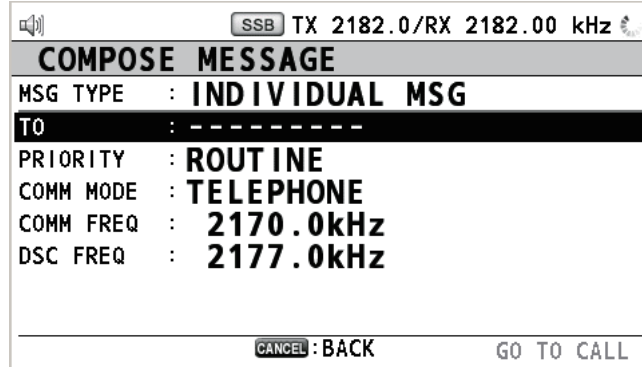

2. Rotate the **ENTER** knob to select [MSG TYPE] then push the knob.
3. Rotate the **ENTER** knob to select [GROUP MSG] then push the knob.

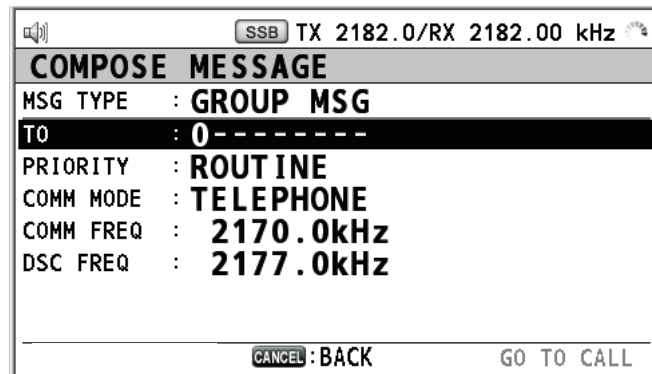

4. With [TO] selected, push the **ENTER** knob.
5. Rotate the **ENTER** knob to select [DIRECT INPUT] or [ADDRESS BOOK DATA] then push the knob.  
 [ADDRESS BOOK DATA]: Select an MMSI from the [ADDRESS BOOK] (see section 6.15) then push the **ENTER** knob.  
 [DIRECT INPUT]: Enter group MMSI (eight digits) with the numeric keys then push the **ENTER** knob.
6. With [COMM MODE] selected, push the **ENTER** knob.
7. Rotate the **ENTER** knob to select [TELEPHONE] or [NBDP-FEC] then push the knob.
8. Rotate the **ENTER** knob to select [DSC FREQ] then push the knob.
9. Rotate the **ENTER** knob to select DSC frequency desired then push the knob (see "How to set DSC frequency" on page 5-3). The communication frequency changes in conjunction with DSC frequency. If you change the communication frequency, go to step 10. If not, go to step 13.
10. Rotate the **ENTER** knob to select [COMM FREQ] then push the knob.
11. Rotate the **ENTER** knob to select [FREQUENCY] or [CHANNEL] then push the knob.

12. Referring to "How to set working channel, frequency" on page 5-4, set the frequency or channel.
13. Rotate the **ENTER** knob to select [GO TO CALL] then push the knob to send the group call. The screen changes as below.

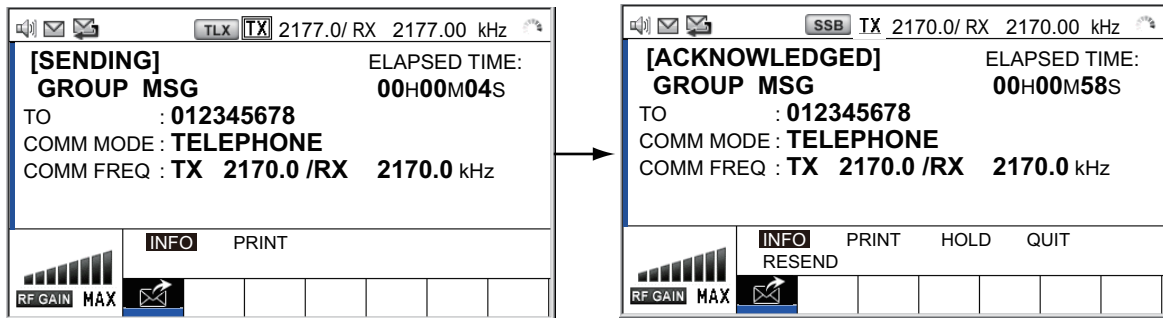

14. Communicate by radiotelephone or NBDP (see "How to send message by NBDP terminal unit" on page 5-5).
15. After you have completed communications, rotate the **ENTER** knob to select [QUIT] in the user options area then push the knob.

## 5.2.2 How to receive a group call

Group MMSI must be registered in order to receive a group call (see paragraph 6.15.2).

When a group call is received, the audio alarm sounds. The icon (✉) appears in the tab area, and the pop-up message "GROUP message received! [CANCEL]: Stop alarm" appears.

1. Press the **CANCEL** key to silence the audio alarm and erase the pop-up message. The frequency is automatically tuned to the received frequency.
2. Watch on the working frequency. Communicate by radiotelephone or NBDP (see the following "Group call received by NBDP terminal unit").
3. After you have completed communications, rotate the **ENTER** knob to select [QUIT] in the user options area then push the knob.

### Group call received by NBDP terminal unit

After receiving a group call, confirm the following.

- The control unit's screen shows the TX and RX frequencies.
- The message from the sending station appears on your NBDP terminal unit.

## 5.3 Geographical Area Call

The purpose of a geographical area call is to send a call to all ships within the area you designate. In the figure below, for example, the call is sent to all ships within 24-34°N, 135-140°W (QUADRANT) and 34°N, 140°W, range: 500 NM (CIRCLE).

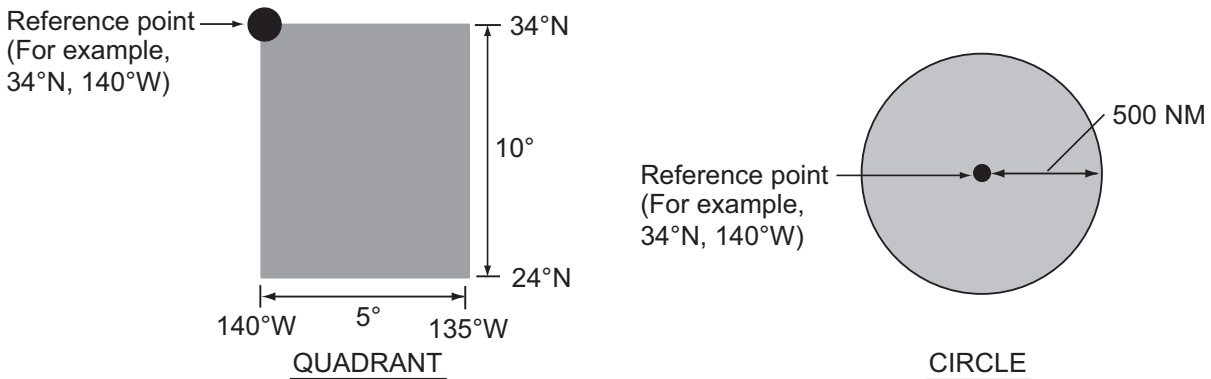

### 5.3.1 How to send a geographical area call

1. Press the **OTHER DSC MSG** key.

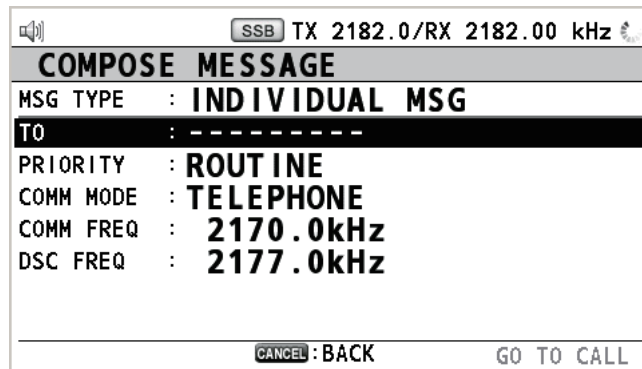

2. Rotate the **ENTER** knob to select [MSG TYPE] then push the knob.
3. Rotate the **ENTER** knob to select [AREA MSG] then push the knob.

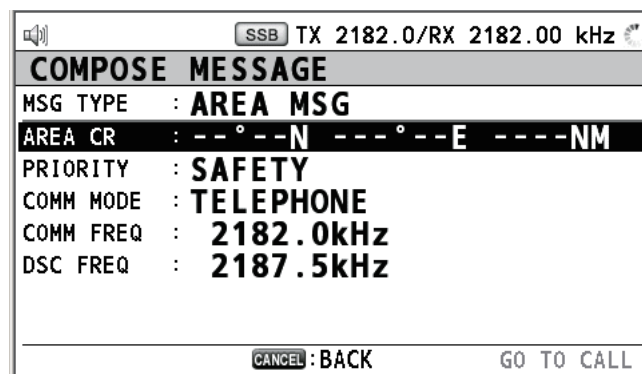

4. With [AREA CR] selected, push the **ENTER** knob.



5. Rotate the **ENTER** knob to select [CIRCLE] or [QUADRANT] then push the knob.

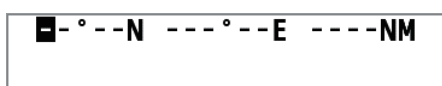

CIRCLE setting window

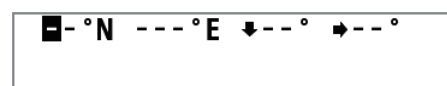

QUADRANT setting window

[CIRCLE]: Using the numeric keys, enter latitude and longitude of reference point and radius of area. To change coordinate, select it and press the **1** key for North or East; **2** key for South or West. After entering data, push the **ENTER** knob.

[QUADRANT]: Using the numeric keys, enter latitude and longitude of reference point and southerly degrees and easterly degrees of area. To change coordinate, select it and press the **1** key for North or East; **2** key for South or West. After entering data, push the **ENTER** knob.

6. With [PRIORITY] selected, push the **ENTER** knob.



7. Rotate the **ENTER** knob to select [SAFETY] or [URGENCY] then push the knob.  
 8. With [COMM MODE] selected, push the **ENTER** knob.  
 9. Rotate the **ENTER** knob to select [TELEPHONE] or [NBDP-FEC] then push the knob.  
 10. Rotate the **ENTER** knob to select [DSC FREQ] then push the knob.

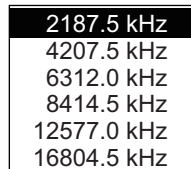

11. Rotate the **ENTER** knob to select DSC frequency desired then push the knob. The communication frequency changes in conjunction with DSC frequency. If you change the communication frequency, go to step 12. If not, go to step 15.  
 12. Rotate the **ENTER** knob to select [COMM FREQ] then push the knob.  
 13. Rotate the **ENTER** knob to select [FREQUENCY] or [CHANNEL] then push the knob.  
 14. Referring to "How to set working channel, frequency" on page 5-4, set the frequency or channel.  
 15. Rotate the **ENTER** knob to select [GO TO CALL] then push the knob to send the call.

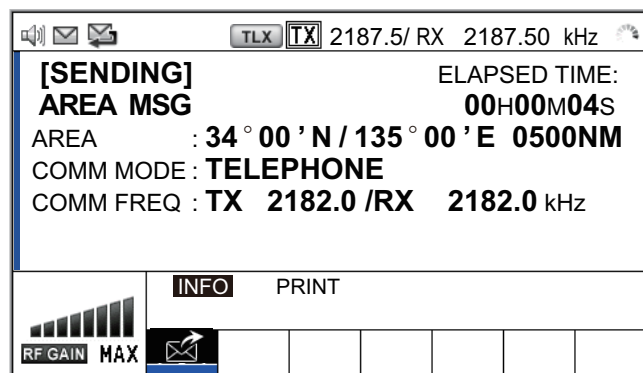

16. Communicate by radiotelephone or NBDP (see "How to send message by NBDP terminal unit" on page 5-5).  
 17. After you have completed communications, rotate the **ENTER** knob to select [QUIT] in the user options area then push the knob.

### 5.3.2 How to receive a geographical area call

When you receive a geographical area message, the audio alarm sounds. The icon (📧) appears in the tab area, and the pop-up message "SAFETY (URGENCY) AREA message received! [CANCEL]: Stop alarm" appears.

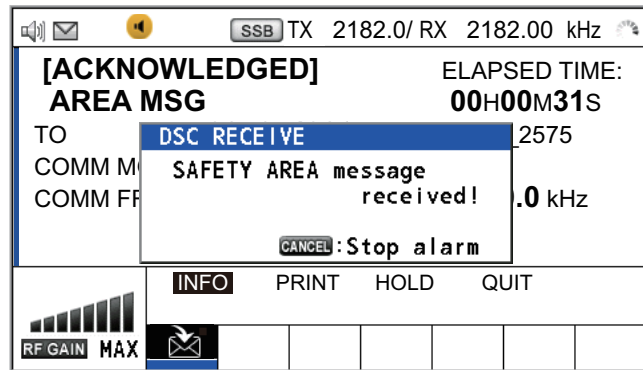

1. Press the **CANCEL** key to silence the audio alarm and erase the pop-up message. The frequency is automatically tuned to the received frequency.
2. Watch on the working frequency. Communicate by radiotelephone or NBDP (see the following "Geographical area call received by NBDP terminal unit").
3. After you have completed communications, rotate the **ENTER** knob to select [QUIT] in the user options area then push the knob.

#### Geographical area call received by NBDP terminal unit

After receiving a geographic area call, confirm the following.

- The control unit's screen shows the TX and RX frequencies.
- The message from the sending station appears on your NBDP terminal unit.

## 5.4 Neutral Craft Call

The neutral craft call, which contains your ship's position and MMSI, informs all ships that your ship is not a participant in an armed conflict. The neutral craft call must be enabled on the [SPECIAL MSG] menu. See section 6.18.

### 5.4.1 How to send a neutral craft call

1. Press the **OTHER DSC MSG** key.

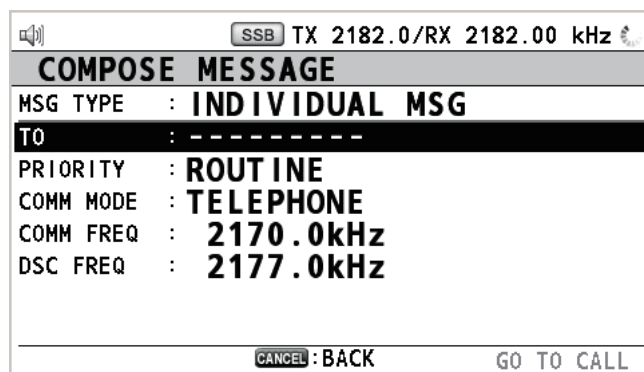

2. Rotate the **ENTER** knob to select [MSG TYPE] then push the knob.

3. Rotate the **ENTER** knob to select [SPECIAL MSG] then push the knob.

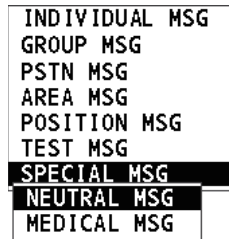

4. Rotate the **ENTER** knob to select [NEUTRAL MSG] then push the knob. [PRIORITY] is automatically selected to [URGENCY].

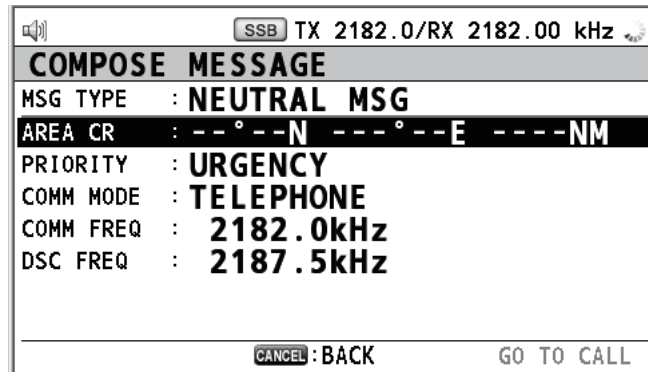

5. With [AREA CR] selected, push the **ENTER** knob.
6. Enter the area range referring to step 5 in paragraph 5.3.1.
7. With [COMM MODE] selected, push the **ENTER** knob.
8. Rotate the **ENTER** knob to select [TELEPHONE] or [NBDP-FEC] then push the knob.
9. Rotate the **ENTER** knob to select [DSC FREQ] then push the knob.
10. Rotate the **ENTER** knob to select DSC frequency desired then push the knob. The communication frequency changes in conjunction with DSC frequency. If you change the communication frequency, go to step 11. If not, go to step 14.
11. Rotate the **ENTER** knob to select [COMM FREQ] then push the knob.
12. Rotate the **ENTER** knob to select [FREQUENCY] or [CHANNEL] then push the knob.
13. Referring to "How to set working channel, frequency" on page 5-4, set the frequency or channel.
14. Rotate the **ENTER** knob to select [GO TO CALL] then push the knob to send the neutral craft call.

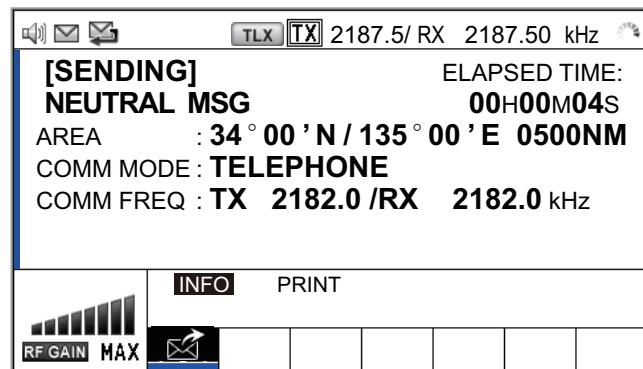

## 5. DSC GENERAL MESSAGE CALLING, RECEIVING

15. Inform all ships by radiotelephone that your ship is not a participant in armed conflict. For communication by NBDP, see "How to send message by NBDP terminal unit" on page 5-5.
16. After you have completed communications, rotate the **ENTER** knob to select [QUIT] in the user options area then push the knob.

### 5.4.2 How to receive a neutral craft call

When you receive a neutral craft call, the audio alarm sounds. The icon (✉) appears in the tab area, and the pop-up message "NEUTRAL message received! [CANCEL]: Stop alarm" appears.

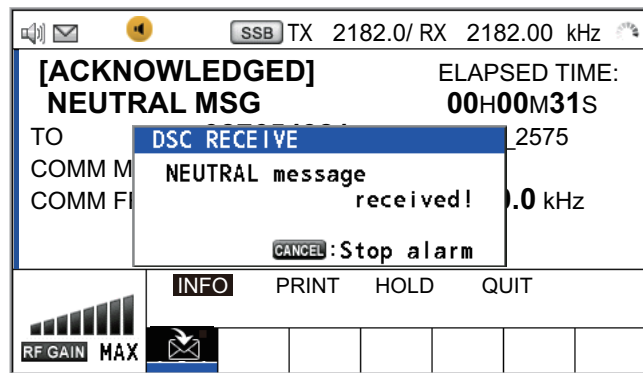

1. Press the **CANCEL** key to silence the audio alarm and erase the pop-up message.
2. With [INFO] selected, push the **ENTER** knob to see the detailed information.

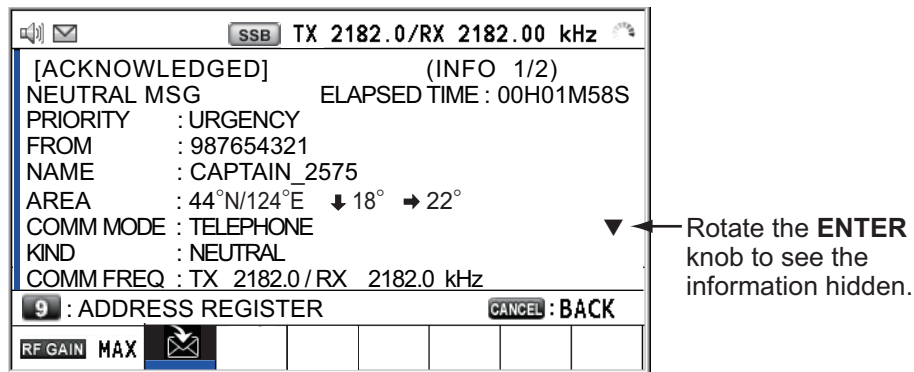

3. Watch on the working frequency. Communicate by radiotelephone or NBDP (see the following "Neutral craft call received by NBDP terminal unit").
4. After you have completed communications, rotate the **ENTER** knob to select [QUIT] in the user options area then push the knob.

#### Neutral craft call received by NBDP terminal unit

After receiving a neutral craft call, confirm the following.

- The control unit's screen shows the TX and RX frequencies.
- The message from the sending station appears on your NBDP terminal unit.



## 5.5 Medical Transport Call

The medical transport call informs all ships, by urgency priority, that your ship carries medical supplies. The medical transport call must be enabled on the [SPECIAL MSG] menu. See section 6.18.

### 5.5.1 How to send a medical transport call

1. Press the **OTHER DSC MSG** key.

SSB TX 2182.0/RX 2182.00 kHz

**COMPOSE MESSAGE**

MSG TYPE : **INDIVIDUAL MSG**

TO : - - - - -

PRIORITY : **ROUTINE**

COMM MODE : **TELEPHONE**

COMM FREQ : **2170.0kHz**

DSC FREQ : **2177.0kHz**

CANCEL : BACK GO TO CALL

2. Rotate the **ENTER** knob to select [MSG TYPE] then push the knob.
3. Rotate the **ENTER** knob to select [SPECIAL MSG] then push the knob.
4. Rotate the **ENTER** knob to select [MEDICAL MSG] then push the knob. [PRIORITY] is automatically selected to [URGENCY].

SSB TX 2182.0/RX 2182.00 kHz

**COMPOSE MESSAGE**

MSG TYPE : **MEDICAL MSG**

AREA CR : - - ° - - N - - - ° - - E - - - - NM

PRIORITY : **URGENCY**

COMM MODE : **TELEPHONE**

COMM FREQ : **2182.0kHz**

DSC FREQ : **2187.5kHz**

CANCEL : BACK GO TO CALL

5. With [AREA CR] selected, push the **ENTER** knob.
6. Enter the area range referring to step 5 in paragraph 5.3.1.
7. With [COMM MODE] selected, push the **ENTER** knob.
8. Rotate the **ENTER** knob to select [TELEPHONE] or [NBDF-FEC] then push the knob.
9. Rotate the **ENTER** knob to select [DSC FREQ] then push the knob.
10. Rotate the **ENTER** knob to select DSC frequency desired then push the knob. The communication frequency changes in conjunction with DSC frequency. If you change the communication frequency, go to step 11. If not, go to step 14.
11. Rotate the **ENTER** knob to select [COMM FREQ] then push the knob.
12. Rotate the **ENTER** knob to select [FREQUENCY] or [CHANNEL] then push the knob.
13. Referring to "How to set working channel, frequency" on page 5-4, set the frequency or channel.

5. DSC GENERAL MESSAGE CALLING, RECEIVING

14. Rotate the **ENTER** knob to select [GO TO CALL] then push the knob to send the medical transport call.

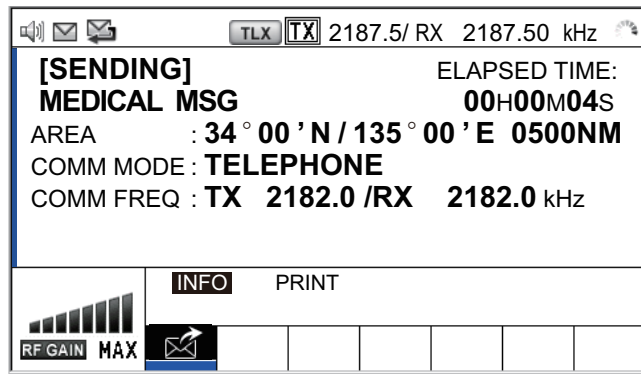

15. Inform all ships by radiotelephone that your ship is transporting medical supplies. For communication by NBDP, see "How to send message by NBDP terminal unit" on page 5-5.
16. After you have completed communications, rotate the **ENTER** knob to select [QUIT] in the user options area then push the knob.

### 5.5.2 How to receive a medical transport call

When you receive a medical transport call, the audio alarm sounds. The icon (✉) appears in the tab area, and the pop-up message "MEDICAL message received! [CANCEL]: Stop alarm" appears.

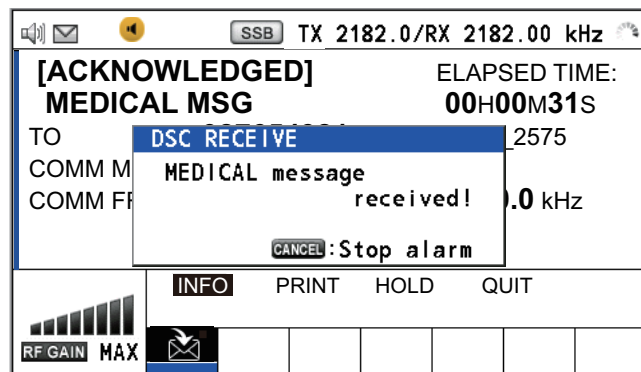

1. Press the **CANCEL** key to silence the audio alarm and erase the pop-up message.
2. With [INFO] selected, push the **ENTER** knob to see the detailed information.

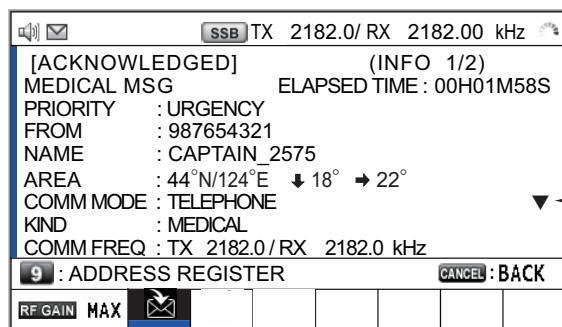

▼ Rotate the **ENTER** knob to see the information hidden.

3. Watch on the working frequency. Communicate by radiotelephone or NBDP (see the following "Medical transport call received by NBDP terminal unit").

- After you have completed communications, rotate the **ENTER** knob to select [QUIT] in the user options area then push the knob.

### **Medical transport call received by NBDP terminal unit**

After receiving a medical transport call, confirm the following.

- The control unit's screen shows the TX and RX frequencies.
- The message from the sending station appears on your NBDP terminal unit.

## 5.6 How to Receive a Polling Request

Polling means another ship wants to confirm if it is within communicating range of your ship.

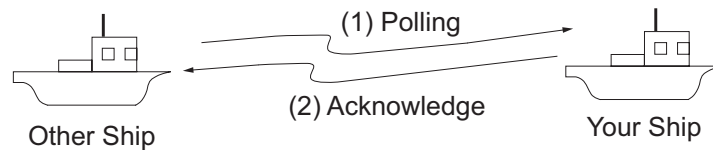

### 5.6.1 Automatic reply

When a polling request message is received with [AUTO] setting on [POLLING MSG] of the [ACK SETTINGS] menu, an acknowledge is sent automatically. For details see section 6.17 ([PRIORITY]: [ROUTINE] only).

### 5.6.2 Manual reply

When you receive a polling request message, the audio alarm sounds. The icon (✉) appears in the tab area, and the pop-up message "POLLING message received! [CANCEL]: Stop alarm" appears. The equipment is set up for manual acknowledge: [POLLING MSG] on the [ACK SETTINGS] menu is [MANUAL].

- Press the **CANCEL** key to silence the audio alarm and erase the pop-up message.
- Rotate the **ENTER** knob to select [ACK] (in the User Option area), then push the knob to send the polling acknowledge message.
- Rotate the **ENTER** knob to select [QUIT] (in the User Option area) then push the knob.

## 5.7 Position Call

There are two types of position calls: your ship requests position of another ship and other station requires your ship's position.

### Find position of other station

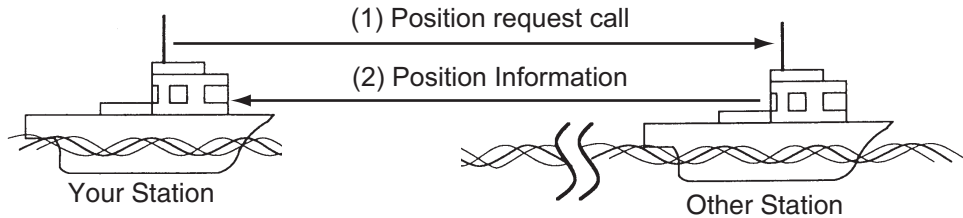

### Send your ship's position to other station

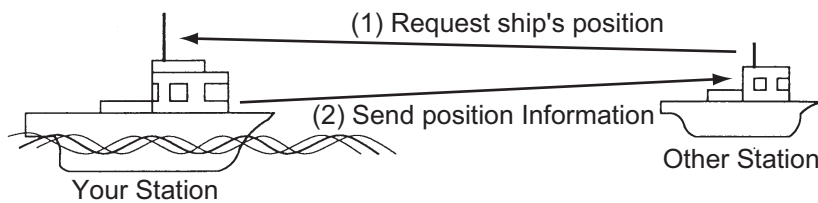

### 5.7.1 How to request other ship's position

1. Press the **OTHER DSC MSG** key.

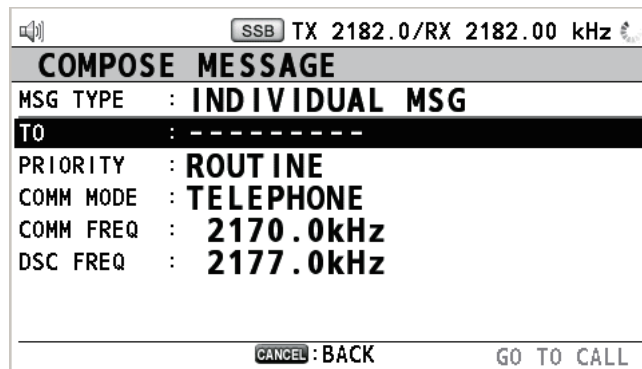

2. Rotate the **ENTER** knob to select [MSG TYPE] then push the knob.
3. Rotate the **ENTER** knob to select [POSITION MSG] then push the knob. [PRIORITY] is automatically selected to [SAFETY].

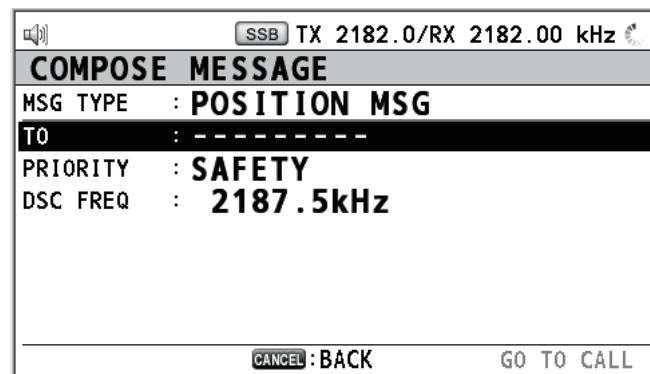

4. With [TO] selected, push the **ENTER** knob.

5. Rotate the **ENTER** knob to select [DIRECT INPUT] or [ADDRESS BOOK DATA] then push the knob.  
 [ADDRESS BOOK DATA]: Select an MMSI from the [ADDRESS BOOK] (see section 6.15) then push the **ENTER** knob.  
 [DIRECT INPUT]: Enter MMSI of station, which you want to know its position, with the numeric keys then push the **ENTER** knob.
6. With [DSC FREQ] selected, push the **ENTER** knob.
7. Rotate the **ENTER** knob to select DSC frequency desired then push the knob.
8. With [GO TO CALL] selected, push the **ENTER** knob to send the position call. The screen changes as below.

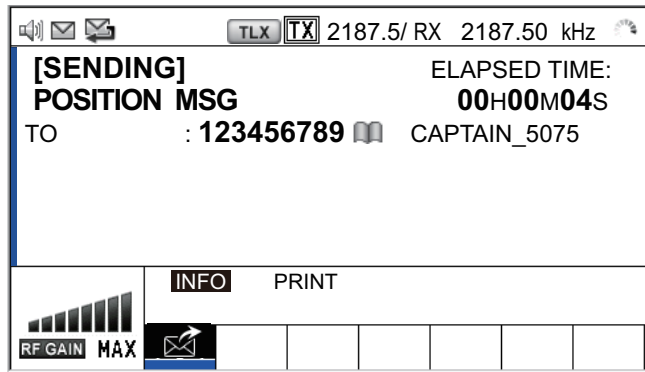

After the call has been sent, the WAIT FOR ACK screen appears as below. The elapsed time since sending the call is displayed.

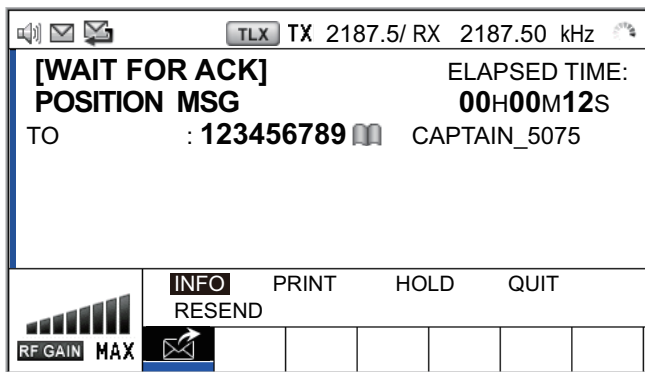

When you receive an acknowledge message, the audio alarm sounds and a pop-up message appears.

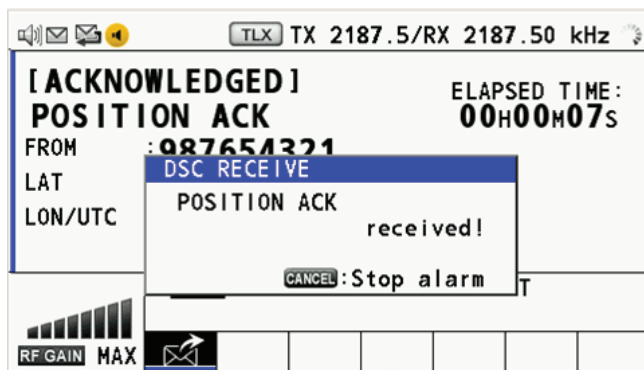

## 5. DSC GENERAL MESSAGE CALLING, RECEIVING

9. Press the **CANCEL** key to silence the audio alarm and erase the pop-up message. There are two types of ACK screens; one with position information and one with no position information.

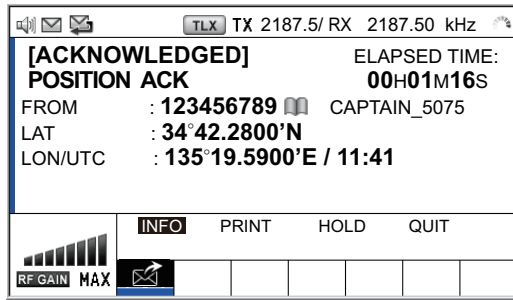

Position information included

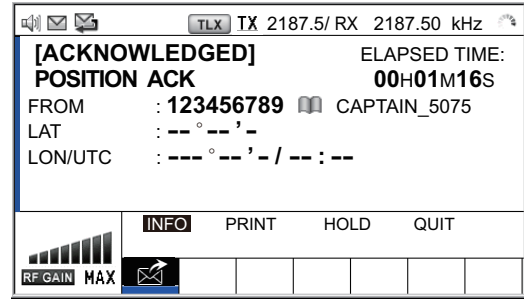

No position information

### 5.7.2 Other ship requests your position

You can turn automatic acknowledge of position request on with [POSITION MSG] on the [ACK SETTINGS] menu (see section 6.17).

#### Automatic reply

When another ship requests your position and the setting of [POSITION MSG] on the [ACK SETTINGS] menu is [AUTO], the equipment automatically transmits a reply. There are two types of automatic replies; one with position information (the setting is [AUTO (ABLE)]) and the other with no position information (the setting is [AUTO (UNABLE)]).

#### Manual reply

When a position request message is received and the setting of [POSITION MSG] on the [ACK SETTINGS] menu is [MANUAL], send the reply manually.

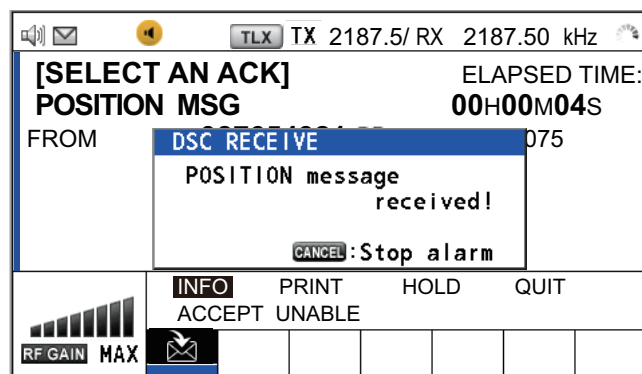

To silence the audio alarm, press the **CANCEL** key.

- **Send the ACK with position information:**  
With [ACCEPT] selected, push the **ENTER** knob.

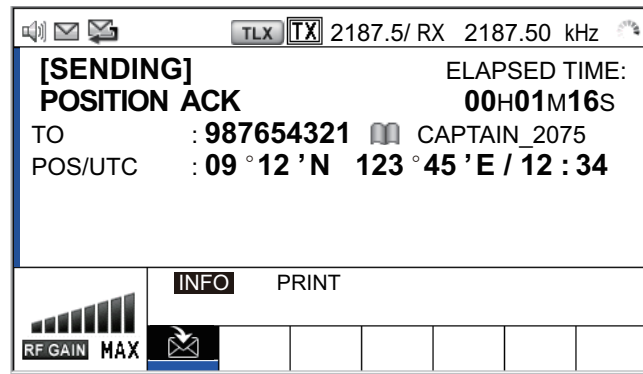

- **To send the ACK with no position information:**  
Rotate the **ENTER** knob to select [UNABLE] in the user options area then push the knob. The screen changes as below.

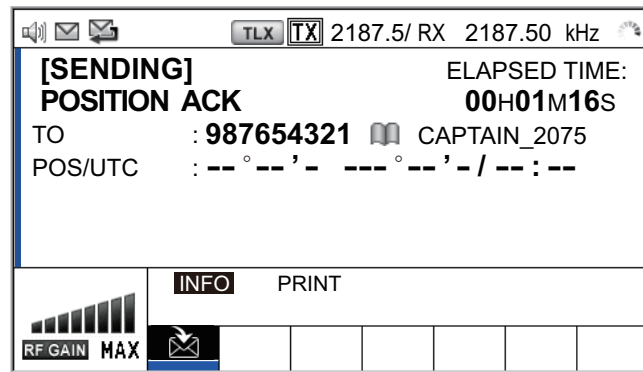

## 5.8 PSTN Call

The PSTN call allows the making and receiving of telephone calls over public switched telephone networks. To use the PSTN call feature, use a handset which has a HOOK ON/OFF function. The standard supply handset has this feature.

### 5.8.1 How to send a PSTN call

1. Press the **OTHER DSC MSG** key.

SSB TX 2182.0/RX 2182.00 kHz

**COMPOSE MESSAGE**

MSG TYPE : **INDIVIDUAL MSG**

TO : -----

PRIORITY : **ROUTINE**

COMM MODE : **TELEPHONE**

COMM FREQ : **2170.0kHz**

DSC FREQ : **2177.0kHz**

CANCEL: BACK GO TO CALL

2. Rotate the **ENTER** knob to select [MSG TYPE] then push the knob.
3. Rotate the **ENTER** knob to select [PSTN MSG] then push the knob.

SSB TX 2182.0/RX 2182.00 kHz

**COMPOSE MESSAGE**

MSG TYPE : **PSTN MSG**

TO : **00**-----

COMM MODE : **TELEPHONE**

COMM FREQ : **NO INFO**

TEL NO. : -----

DSC FREQ : **2189.5kHz**

CANCEL: BACK GO TO CALL

4. With [TO] selected, push the **ENTER** knob.
5. Rotate the **ENTER** knob to select [DIRECT INPUT] or [ADDRESS BOOK DATA] then push the knob.  
[ADDRESS BOOK DATA]: Select an MMSI from the [ADDRESS BOOK] (see section 6.15) then push the **ENTER** knob.  
[DIRECT INPUT]: Enter MMSI of coast station (seven digits) with the numeric keys then push the **ENTER** knob.
6. Rotate the **ENTER** knob to select [TEL NO.] then push the knob.
7. Enter telephone no. (up to 16 digits) with the numeric keys then push the **ENTER** knob.
8. With [DSC FREQ] selected, push the **ENTER** knob.
9. Rotate the **ENTER** knob to select DSC frequency then push the knob (see "Routine priority" in "How to set DSC frequency" on page 5-3).
10. With [GO TO CALL] selected, push the **ENTER** knob to send the PSTN call. After the call has been sent, the WAIT FOR ACK screen appears. The elapsed time since sending the call is displayed. When you receive an acknowledge message, a pop-up message appears.
11. Do one of the following depending on ACK message.



**Able acknowledge message received**

If you received PSTN ABLE ACK from a coast station, the pop-up message "PSTN calling! Pick up HANDSET!" appears and the audio alarm sounds. The communication frequency changes to the working frequency and PSTN CONNECTION CALL is sent automatically. (PSTN CONNECTION CALL has a role to check quality of communication on the working frequency.)

**Note 1:** If you have already picked up the handset before the pop-up message appears, a pop-up message which suggests you to push the **ENTER** knob appears. Push the **ENTER** knob to accept.

**Note 2:** If you do not receive PSTN ACK message within 25 seconds, the pop-up message "PSTN disconnected because of timeout. [CANCEL]: Close window" appears.

1. To start the communications:

If you received ABLE ACK, which indicates the quality test is successful, on the working frequency within 25 seconds of starting transmission of PSTN CONNECTION CALL, the PSTN call is connected. Pick up the handset and communicate with the party you called. The elapsed time since starting communication is displayed.

**Note:** When you receive this ABLE ACK on the working frequency in on hook condition, END OF CALL is sent automatically. The communication is disconnected.

2. To quit the communications, do one of the following.

- On hook the handset or press the **CANCEL** key. END OF CALL is sent automatically. The waiting ACK for END OF CALL screen appears. When you receive the ACK, rotate the **ENTER** knob to select [QUIT] then push the knob.
- When the PSTN line is disconnected by the coast station, you receive the END OF ACK message. Rotate the **ENTER** knob to select [QUIT] then push the knob.

**Unable acknowledge message received**

When you receive an unable acknowledge message, the audio alarm sounds and a pop-up message appears. Rotate the **ENTER** knob to select [QUIT] then push the knob.

## 5.8.2 How to receive a PSTN call

When a PSTN call is received, the  icon appears in the tab area. An able/unable acknowledge is sent automatically according to the setting of [PSTN] on the [ACK SETTINGS].

- [AUTO (ABLE)]: The automatic able acknowledge (which means you can call with party) is sent.
- [AUTO (UNABLE)]: The automatic unable acknowledge (which means you cannot call with party) is sent.

### **Able acknowledgment**

The automatic able acknowledge is sent and the pop-up message "PSTN connected pick up HANDSET!" appears.

**Note:** If you have already picked up the handset before the pop-up message appears, a pop-up message which suggests you to push the **ENTER** knob appears. Push the **ENTER** knob to accept.

1. Pick up the handset. When you receive PSTN ACK of connection, the screen for telephone calling appears. Communicate with the party. The elapsed time since starting communication is displayed.
2. To quit the communication, do one of the following.
  - On hook the handset or press the **CANCEL** key. END OF CALL is sent automatically. The waiting ACK for END OF CALL screen appears. When you receive the ACK, rotate the **ENTER** knob to select [QUIT] then push the knob.
  - When the PSTN line is disconnected by the coast station, you receive the END OF ACK message. Rotate the **ENTER** knob to select [QUIT] then push the knob.

After disconnection of PSTN line, the charge information is sent.

### **Unable acknowledgment**

The automatic unable acknowledge is sent. The audio alarm sounds and the LED flashes in green. Press the **CANCEL** key.

# 6. MENU OPERATION

The menu can be accessed from both the RT and DSC screens.

**Note:** The menu can not be opened when awaiting acknowledgment of a distress alert.

## 6.1 How to Open/Close the MENU Screen

1. Press the **MENU** key to open the [MENU] screen.

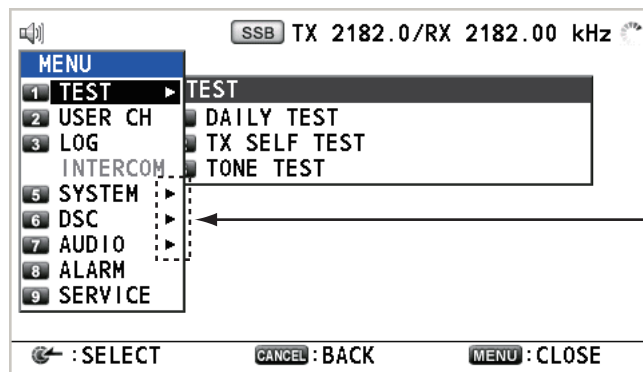

2. Rotate the **ENTER** knob to select the desired menu item then push the knob. You can also select the desired menu item by pressing the 1 to 9 keys. The menu items that have a ► indicate additional menus.

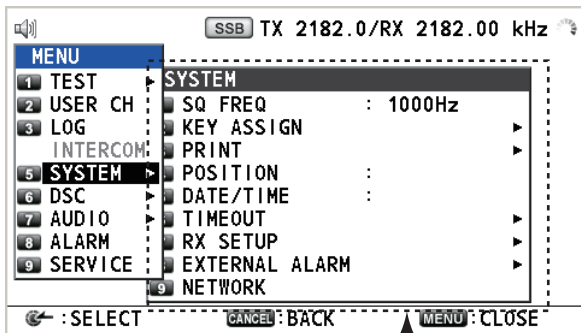

Menu items in next layer

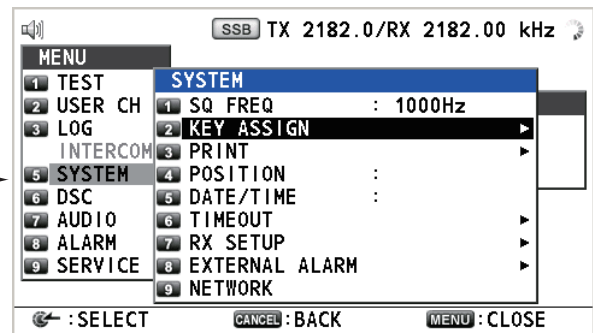

Second layer

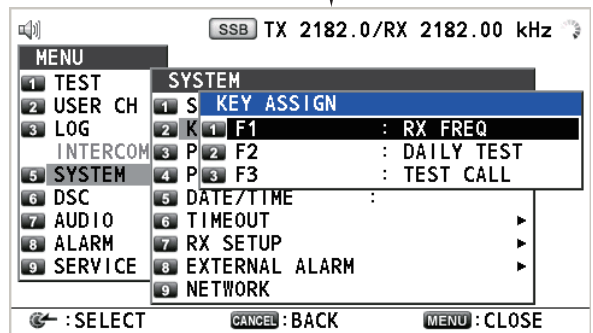

Third layer

*Example screens for [SYSTEM]*

3. To close the menu screen, press the **MENU** key.

## 6.2 User Channels

The [USER CH] menu allows registration and deleting of user TX and RX channels, which are available where permitted by the Authorities. A maximum of 256 channels can be registered. A user channel consists of four or five digits. The setting range is 01 to 029 for band, 00 to 99 for band channel.



NOTICE

FURUNO will assume no responsibility for the disturbance caused by the unlawful or improper setting of user channels.

### 6.2.1 List for user channels

Rotate the **ENTER** knob to select [USER CH] on the [MENU] screen then push the knob. The list for user channels appears.

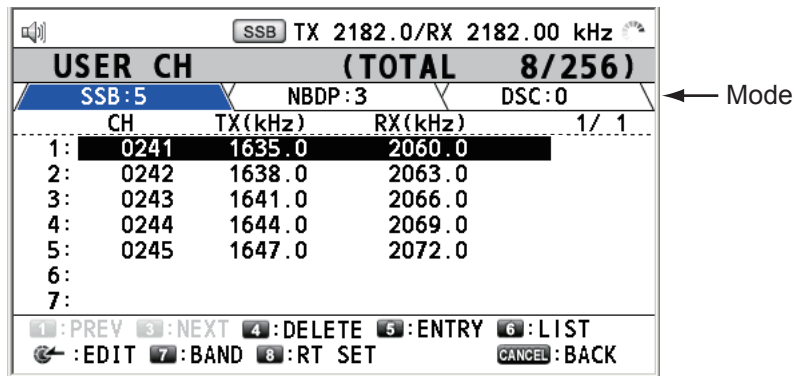

Press the **6** key several times to select a desired mode among [SSB], [NBDP] and [DSC]. Rotate the **ENTER** knob (or press the **1** key for the previous page and the **3** key for the next page) to scroll the screen. To return to the [MENU] screen, press the **CANCEL** key.

### 6.2.2 How to register user channels

1. Press the **5** key on the [USER CH] list to open the [USER CH ENTRY] screen.

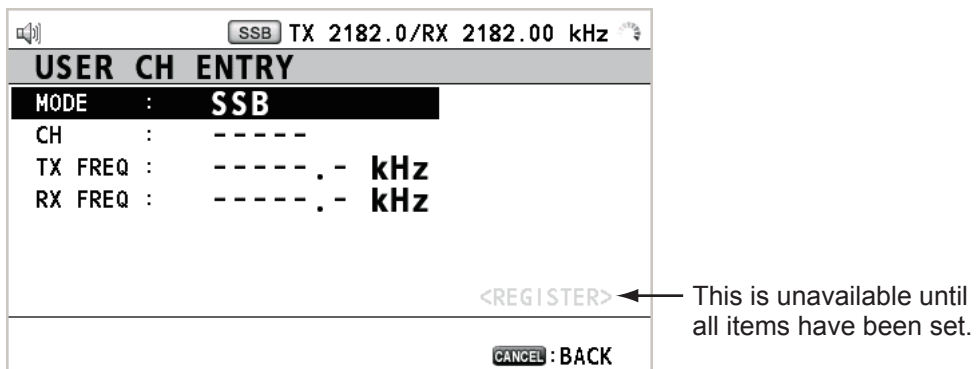

- With [MODE] selected, push the **ENTER** knob.

SSB
NBDP
DSC

- Rotate the **ENTER** knob to select the mode desired then push the knob.
- With [CH] selected, push the **ENTER** knob.

0
BAND: (1-29)
CH: (00-99)

- Enter band and band channel with the numeric keys.
- With [TX FREQ] selected, push the **ENTER** knob.
- Enter TX frequency with the numeric keys.
- With [RX FREQ] selected, push the **ENTER** knob.
- Enter RX frequency with the numeric keys.
- With [REGISTER] selected, push the **ENTER** knob.

### 6.2.3 How to edit user channels

- Rotate the **ENTER** knob to select the user channel to edit on the [USER CH] list then push the knob.

SSB TX 2182.0/RX 2182.00 kHz			
<b>USER CH (TOTAL 8/256)</b>			
SSB:5	NBDP:3	DSC:0	
CH	TX (kHz)	RX (kHz)	1/ 1
1: 0200	2000.0	2182.0	
2: 0301	3000.0	2182.0	
3: <b>0402</b>	<b>4000.0</b>	<b>2182.0</b>	
4: 02903	5000.0	2182.0	
5: 02904	5000.0	2183.0	
6:			
7:			
[1]:PREV [2]:NEXT [4]:DELETE [5]:ENTRY [6]:LIST [7]:EDIT [8]:BAND [9]:RT SET [CANCEL]:BACK			

Push the **ENTER** knob.

SSB TX 2182.0/RX 2182.00 kHz	
<b>USER CH EDIT</b>	
MODE :	<b>SSB</b>
CH :	<b>0402</b>
TX FREQ :	<b>4000.0 kHz</b>
RX FREQ :	<b>2182.0 kHz</b>
<REGISTER>	
[CANCEL]:BACK	

- Rotate the **ENTER** knob to select the item to edit then push the knob.
- Edit the settings referring to paragraph 6.2.2.
- Rotate the **ENTER** knob to select [REGISTER] then push the knob.

Overwrite this channel Are you sure? Yes <b>No</b>
--

**Note:** If the MODE and CH settings are also assigned to another channel, the alarm sounds and the following warning message appears when selecting [REGISTER].

Channel number overlaps. <b>CANCEL</b> : Close window
--

- Rotate the **ENTER** knob to select [Yes] then push the knob.

### 6.2.4 How to delete user channels

Open the [USER CH] list then follow the applicable procedure below.

#### Individual user channel

1. Rotate the **ENTER** knob to select the user channel to delete then press the **4** key.



2. With [DELETE SELECTION] selected, push the **ENTER** knob.

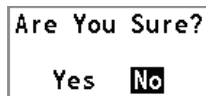

3. Rotate the **ENTER** knob to select [Yes] then push the knob.

#### User channels by mode

1. Press the **6** key several times to select the desired mode.
2. Press the **4** key.
3. Rotate the **ENTER** knob to select [DELETE LIST] then push the knob.
4. Rotate the **ENTER** knob to select [Yes] then push the knob.

#### All user channels

1. Press the **4** key.
2. Rotate the **ENTER** knob to select [DELETE ALL LISTS] then push the knob.
3. Rotate the **ENTER** knob to select [Yes] then push the knob.

### 6.2.5 How to sort the USER CH list by band

1. Press the **7** key on the [USER CH] list.

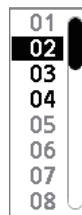

2. Rotate the **ENTER** knob to select the band desired then push the knob. For example, select [02]. Then the user channels are sorted in numerical order from the 02 band.

SSB TX 2182.0/RX 2182.00 kHz			
USER CH		(TOTAL 10/256)	
SSB: 7		NBDP: 3 DSC: 0	
CH	TX(kHz)	RX(kHz)	1/ 1
1: 0200	2000.0	2182.0	
2: 0201	2111.0	2182.0	
3: 0202	2222.0	2182.0	
4: 0301	3000.0	2182.0	
5: 0402	4000.0	2182.0	
6: 02903	5000.0	2182.0	
7: 02904	5000.0	2183.0	

1:PREV 3:NEXT 4:DELETE 5:ENTRY 6:LIST  
 ←:EDIT 7:BAND 8:RT SET CANCEL:BACK

## 6.2.6 How to select user channels for SSB mode

Rotate the **ENTER** knob to select the user channel desired on the [USER CH] list then press the **8** key. The RT screen for the selected user channel appears.

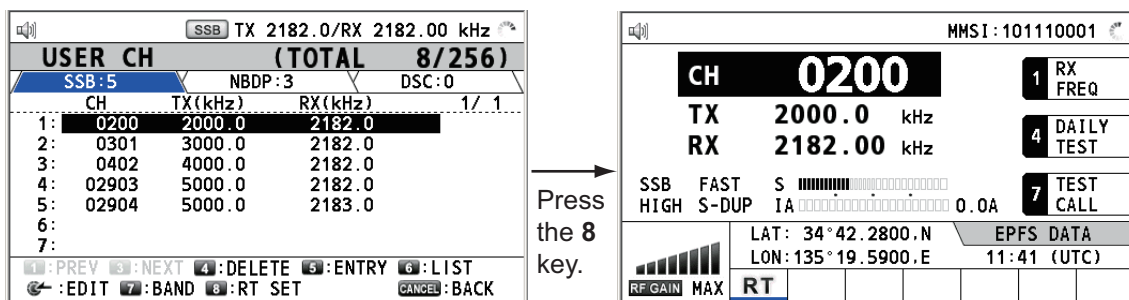

## 6.3 Log File

Three log file modes are provided for storage of calls:

- [RX GENERAL] (received ordinary log)
- [RX DISTRESS] (received distress log)
- [TX] (transmitted log)

Each mode stores 50 calls. The latest call is saved as log no.1 and the log no. of all previous calls in that log increments by one. When the storage capacity is exceeded, the oldest call is deleted to make a room for the latest. The icon () indicates unread calls. Received distress calls are automatically deleted after 48 hours.

### 6.3.1 How to open a log file

The procedure to open a log is common to all logs.

1. Rotate the **ENTER** knob to select [LOG] on the [MENU] screen then push the knob.

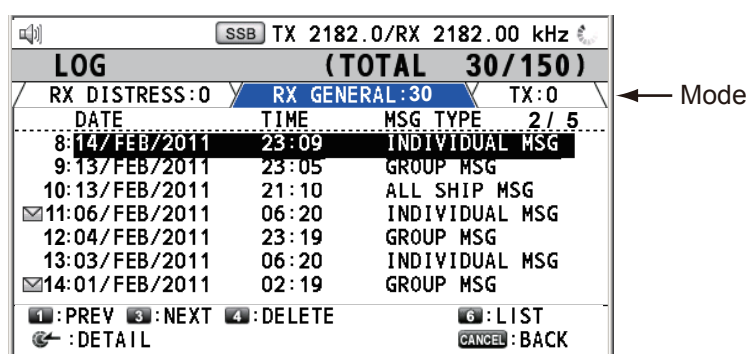

2. Press the **6** key to switch the log file mode in the sequence of [RX DISTRESS] → [RX GENERAL] → [TX] → [RX DISTRESS] →...

## 6. MENU OPERATION

- When there are multiple pages, press the **1** key for the previous page and the **3** key for the next page. Rotate the **ENTER** knob to select a desired log then push the knob. The contents of the selected log file are displayed as below. To return to the [MENU] screen, press the **CANCEL** key.

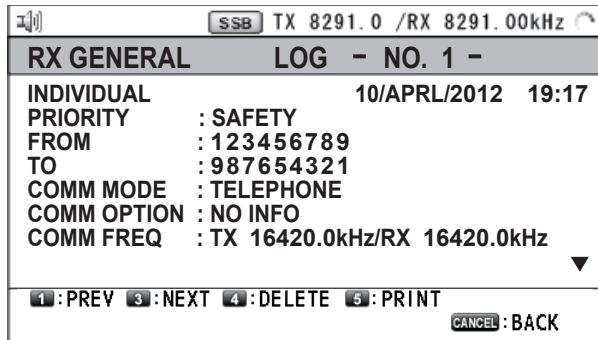

← Rotate the **ENTER** knob to see the information not shown on this screen.

- Rotate the **ENTER** knob to scroll the log. Press the **1** key for the previous log file and the **3** key for the next log file.
- To print the selected log, press the **5** key.
- To return to the log list, press the **CANCEL** key.

### 6.3.2 How to delete log files

You can delete the log files except RX DISTRESS. Open the log file list then follow the applicable procedure below.

#### Individual log file

- Rotate the **ENTER** knob to select the log file to delete then press the **4** key.



- With [DELETE SELECTION] selected, push the **ENTER** knob.

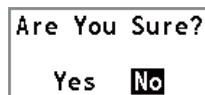

- Rotate the **ENTER** knob to select [Yes] then push the knob.

You can delete a log file by pressing the **4** key on the screen shown at step 3 in paragraph 6.3.1.

#### Specify log files by mode

- Press the **6** key several times to select [RX GENERAL] or [TX].
- Press the **4** key.
- Rotate the **ENTER** knob to select [DELETE LIST] then push the knob.
- Rotate the **ENTER** knob to select [Yes] then push the knob.

#### All log files

- Press the **4** key.
- Rotate the **ENTER** knob to select [DELETE ALL LISTS] then push the knob.
- Rotate the **ENTER** knob to select [Yes] then push the knob.

The log files are renumbered to reflect the deletion.



## 6.4 Squelch Frequency

The squelch frequency (ex. for high voice) can be changed as follows (default setting: 1000 Hz):

1. Rotate the **ENTER** knob to select [SYSTEM] on the [MENU] screen then push the knob.

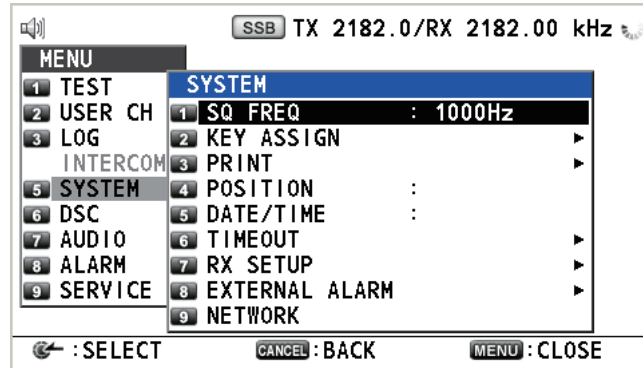

2. With [SQ FREQ] selected, push the **ENTER** knob.

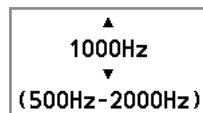

3. Rotate the **ENTER** knob to adjust frequency (setting range: 500-2000 Hz) then push the knob.

## 6.5 Key Assignment

You can program the **1**, **4** and **7** keys to provide one-touch access to a required function. The **1** key is assigned with F1, the **4** key with F2 and the **7** key with F3. The default programs are [RX FREQ] for F1, [DAILY TEST] for F2, and [TEST CALL] for F3. You can program the keys with the functions listed below.

- TX/RX FREQ
- AGC
- TEST CALL
- LOG
- ----- (NONE)\*
- RX FREQ
- TX PWR
- MSG FILE
- INTERCOM
- MODE
- TX MONITOR
- DAILY TEST
- CLARIFIER

\*: NONE: Not assigned any function

**Note:** You cannot assign the same function to two function keys.

1. Rotate the **ENTER** knob to select [SYSTEM] on the [MENU] screen then push the knob.
2. Rotate the **ENTER** knob to select [KEY ASSIGN] then push the knob.

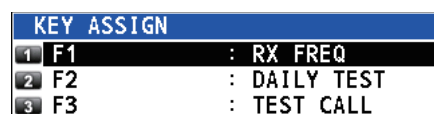

## 6. MENU OPERATION

3. Rotate the **ENTER** knob to select [F1], [F2] or [F3] then push the knob.

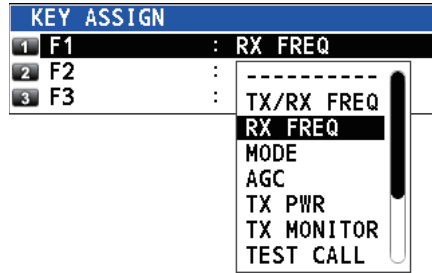

4. Rotate the **ENTER** knob to select the function desired then push the knob.

## 6.6 How to Print Messages

The [PRINT] menu enables/disables automatic printing of all transmitted and received calls and the results of the daily test.

1. Rotate the **ENTER** knob to select [SYSTEM] on the [MENU] screen then push the knob.
2. Rotate the **ENTER** knob to select [PRINT] then push the knob.

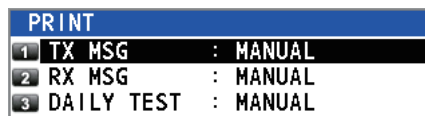

3. With [TX MSG] selected, push the **ENTER** knob.
4. Rotate the **ENTER** knob to select [AUTO] or [MANUAL] then push the knob.
5. Set [RX MSG] and [DAILY TEST] similarly.

## 6.7 Position Setting

Do the following to set your position:

1. Rotate the **ENTER** knob to select [SYSTEM] on the [MENU] screen then push the knob.
2. Rotate the **ENTER** knob to select [POSITION SETUP] then push the knob.

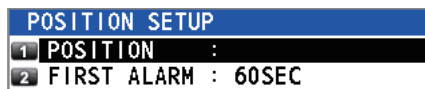

3. With [POSITION] selected, push the **ENTER** knob.

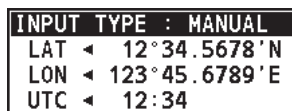

4. With [INPUT TYPE] selected, push the **ENTER** knob.
5. Rotate the **ENTER** knob to select [EPFS], [MANUAL] or [NO INFO] then push the knob.  
[EPFS]: The position data from EPFS  
[MANUAL]: Set the position data manually  
[NO INFO]: No position data  
For [MANUAL], go to next step.

6. For manual input, use the numeric keys to enter latitude/longitude of your position, and UTC. To change coordinate, select it and press the **1** key for North or East; the **2** key for South or West. After entering each data, push the **ENTER** knob.

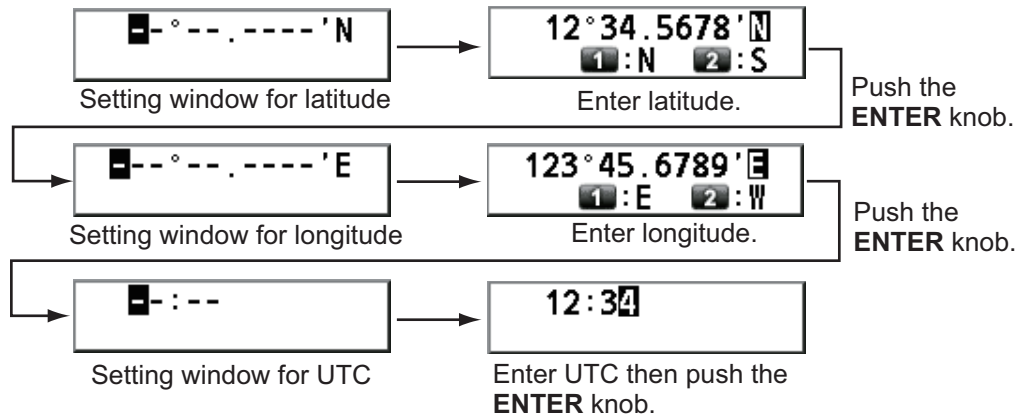

**Note:** When the setting of [INPUT TYPE] is [MANUAL], the message "WARNING: Position data is not updated! Position data was older than 4H. Update it. [CANCEL]: Stop alarm" appears to ask you to update position.

### How to set the timing for "EPFS error!"

You can set the time to display the alarm "EPFS error!", after turning on the power of this equipment.

1. Rotate the **ENTER** knob to select [SYSTEM] on the [MENU] screen then push the knob.
2. Rotate the **ENTER** knob to select [POSITION SETUP] then push the knob.
3. Rotate the **ENTER** knob to select [FIRST ALARM] then push the knob.

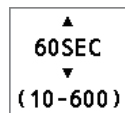

4. Rotate the **ENTER** knob to set the start time (setting range: 10-600 SEC) then push the knob.

## 6.8 Date and Time Setting

Set the date and time for the system.

1. Rotate the **ENTER** knob to select [SYSTEM] on the [MENU] screen then push the knob.
2. Rotate the **ENTER** knob to select [DATE/TIME] then push the knob.
  - Date or time cannot be adjusted when they are input from GPS navigator.

SOURCE : EPFS
DATE : 10/APR/2012
TIME : 12:34 UTC

## 6. MENU OPERATION

- If date or time is not input from GPS navigator, enter date and time with the numeric keys.

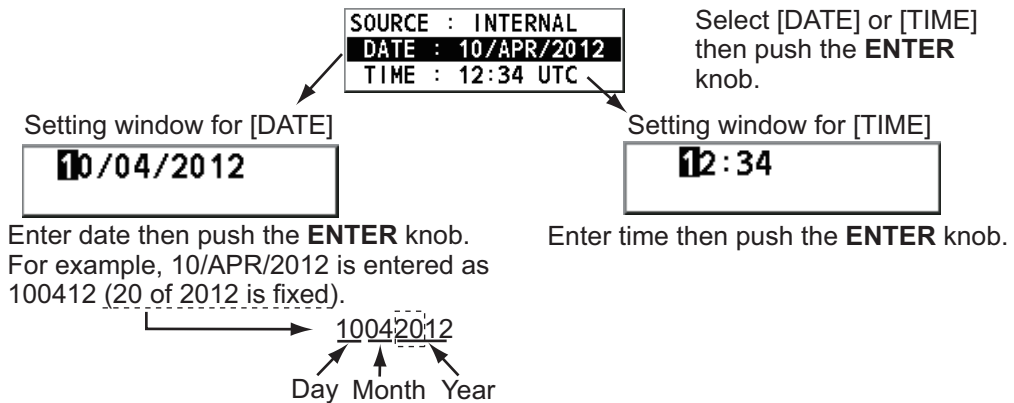

**Note:** When manually entering date and time, use UTC (Universal Time Coordinated). Do not use local time.

## 6.9 Timeout Setting

The menu screen and/or the inactive sessions (icons) can be closed automatically when there is no menu operation for a specific time. You can set the time interval for auto closing of the menu and inactive session.

1. Rotate the **ENTER** knob to select [SYSTEM] on the [MENU] screen then push the knob.
2. Rotate the **ENTER** knob to select [TIMEOUT] then push the knob.

TIMEOUT	
1	MENU END : 10MIN
2	DSC GENERAL : 15MIN
3	RX DISTRESS : NO TIMEOUT
4	SSB : 30SEC
5	TELEX : NO TIMEOUT
	FAX : NO TIMEOUT
7	AM : NO TIMEOUT

\*: [FAX] is unavailable.

3. Rotate the **ENTER** knob to select the item desired then push the knob.
4. Rotate the **ENTER** knob to select time interval then push the knob. [NO TIMEOUT] leaves the menu screen and/or the inactive sessions open until you close them manually.

Item	Description	Option
[MENU END]	Close the menu screen automatically.	10MIN, NO TIMEOUT

Item	Description	Option
[ D S C G E N E R A L ]	Close the inactive sessions except the distress alert.	15MIN, NO TIMEOUT
[ R X D I S T R E S S ]	Close the inactive sessions for the receiving distress alert.	
[SSB]	Close the inactive sessions for RT of SSB and LSB.	10SEC, 30SEC, 10MIN
[TELEX]	Close the inactive sessions for RT of TELEX.	10SEC, 30SEC, 10MIN, NO TIMEOUT
[FAX]*	Close the inactive sessions for RT of FAX.	
[AM]	Close the inactive sessions for RT of AM.	

\*: Refer to section 6.10.

## 6.10 FAX Enable/Disable

You can enable or disable FAX use as follows.

1. Rotate the **ENTER** knob to select [SYSTEM] on the [MENU] screen then push the knob.
2. Rotate the **ENTER** knob to select [RX SETUP] then push the knob.
3. Rotate the **ENTER** knob to select [FAX RX] then push the knob.
4. Rotate the **ENTER** knob to select [ENABLE] or [DISABLE] then push the knob.  
For [ENABLE], "FAX" is added to the class of emission selection menu.

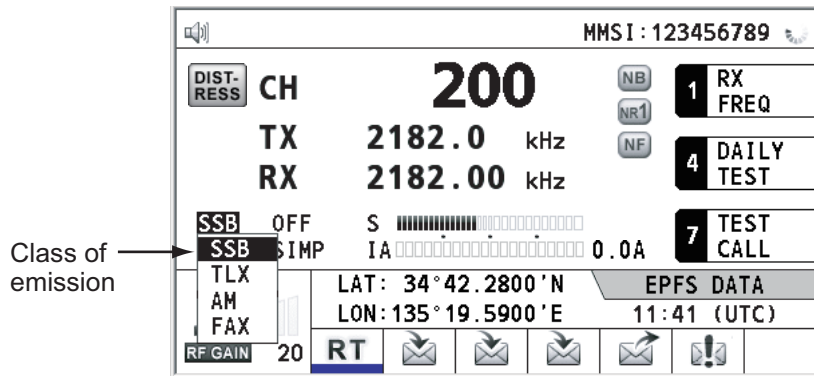

## 6.11 How to Select the Antenna

Select the antenna to use for TX and RX, common or separate.

1. Rotate the **ENTER** knob to select [SYSTEM] on the [MENU] screen then push the knob.
2. Rotate the **ENTER** knob to select [RX SETUP] then push the knob.
3. Rotate the **ENTER** knob to select [ANT SELECT] then push the knob.
4. Rotate the **ENTER** knob to select [TRX ANT] or [RX ANT] then push the knob.

**Note 1:** You can not select [RX ANT] without R\_ANT. Contact your dealer.

**Note 2:** When sharing the WR antenna with R\_ANT, select [RX ANT] so that you can always watch the frequency during transmission.

## 6.12 Clarifier Setting

You can fine-tune the receiving frequency with the clarifier.

1. Rotate the **ENTER** knob to select [SYSTEM] on the [MENU] screen then push the knob.
2. Rotate the **ENTER** knob to select [RX SETUP] then push the knob.
3. Rotate the **ENTER** knob to select [CLARIFIER] then push the knob.
4. Rotate the **ENTER** knob to select [ON] or [OFF] then push the knob.  
For [ON], the indication for clarifier setting appears on the RT screen as shown below.

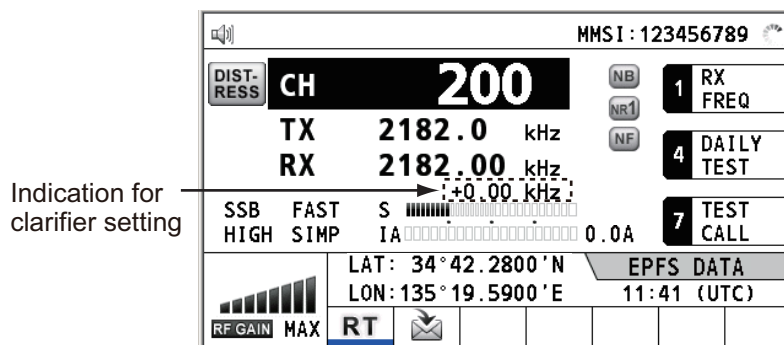

- 1) Rotate the **ENTER** knob to select [+0.00 kHz] then push the knob.

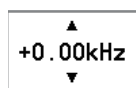

- 2) Rotate the **ENTER** knob to adjust the receiving frequency (setting value: -0.20 to +0.20).

## 6.13 External Alarm Setting

The [EXTERNAL ALARM] menu enables/disables output of the contact signal for urgency, safety and routine frequencies to an external alarm system.

1. Rotate the **ENTER** knob to select [SYSTEM] on the [MENU] screen then push the knob.
2. Rotate the **ENTER** knob to select [EXTERNAL ALARM] then push the knob.

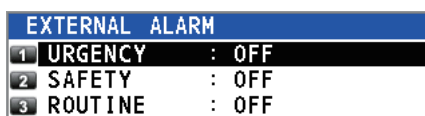

3. Rotate the **ENTER** knob to select [URGENCY], [SAFETY] or [ROUTINE], then push the knob.
4. Rotate the **ENTER** knob to select [ON] or [OFF] then push the knob.

## 6.14 NETWORK Setting

View your network settings on the [NETWORK SETTING (VIEW)] screen.

1. Rotate the **ENTER** knob to select [SYSTEM] on the [MENU] screen then push the knob.
2. Rotate the **ENTER** knob to select [NETWORK] then push the knob.

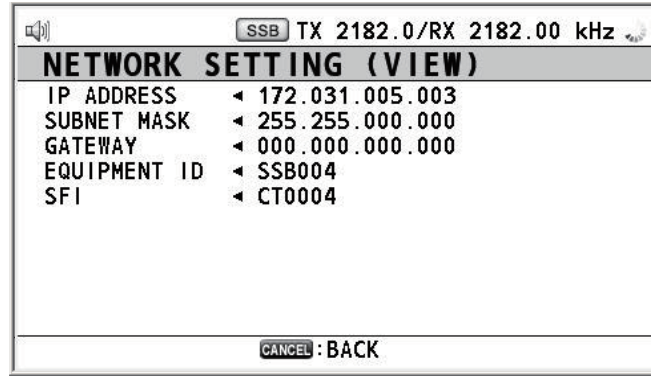

## 6.15 Address Book

You can register a maximum of 50 MMSI or the address name (max. 20 letters) in the memory.

### 6.15.1 List for address data

1. Rotate the **ENTER** knob to select [DSC] on the [MENU] screen then push the knob.
2. Rotate the **ENTER** knob to select [ADDRESSBOOK] then push the knob.

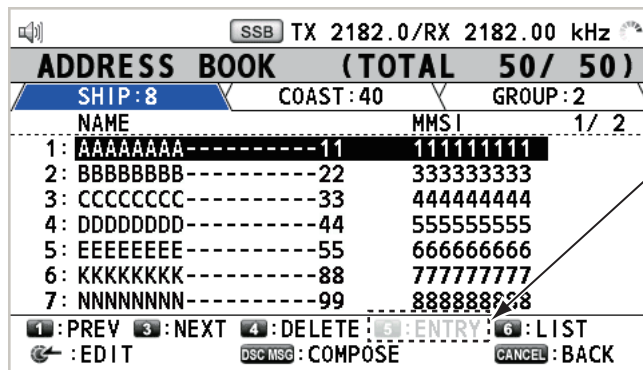

When 50 addresses are registered, this is not available.

Key/knob	Function
<b>ENTER</b>	<ul style="list-style-type: none"> <li>• Move the cursor by rotating the <b>ENTER</b> knob.</li> <li>• Open the [ADDRESS DATA EDIT] screen by pushing the <b>ENTER</b> knob (see paragraph 6.15.3).</li> </ul>
<b>CANCEL</b>	Return to the [MENU] screen.
<b>1</b>	Go to the previous page.
<b>3</b>	Go to the next page.
<b>4</b>	Delete address (see paragraph 6.15.4).
<b>5</b>	Open the [ADDRESS DATA ENTRY] screen (see paragraph 6.15.2).
<b>6</b>	Switch the address type. Each press changes the type continuously (SHIP → COAST → GROUP → SHIP →...).



### 6.15.2 How to register addresses

1. Open the [ADDRESS BOOK] screen.
2. Press the **5** key to open the [ADDRESS DATA ENTRY] screen.

3. With [NAME] selected, push the **ENTER** knob.

4. Enter the address name (max. 20 letters) with the numeric keys then push the **ENTER** knob.
5. With [MMSI] selected, push the **ENTER** knob.

6. Enter the MMSI with the numeric keys then push the **ENTER** knob.
7. With [REGISTER] selected, push the **ENTER** knob.

### 6.15.3 How to edit addresses

1. Open the [ADDRESS BOOK] screen.
2. Rotate the **ENTER** knob to select the address to edit then push the knob.

3. Rotate the **ENTER** knob to select [NAME] or [MMSI] as appropriate then push the knob.
4. Enter the address name or MMSI with the numeric keys then push the **ENTER** knob.

## 6. MENU OPERATION

5. Rotate the **ENTER** knob to select [REGISTER] then push the knob.

Overwrite this address.  
Are you sure?  
Yes **No**

**Note:** If the MMSI is already registered to another address, the error alarm sounds and a warning pop-up message appears when selecting [REGISTER].

MMSI number overlaps.  
**CANCEL**: Close window

6. Rotate the **ENTER** knob to select [Yes] then push the knob.

### 6.15.4 How to delete addresses

Open the [ADDRESS BOOK] screen then follow the applicable procedure below.

#### Individual address

1. Rotate the **ENTER** knob to select the address to delete then press the **4** key.

**DELETE SELECTION**  
DELETE LIST  
DELETE ALL LISTS

2. With [DELETE SELECTION] selected, push the **ENTER** knob.

Are You Sure?  
Yes **No**

3. Rotate the **ENTER** knob to select [Yes] then push the knob.

#### Address by type

1. Press the **6** key several times to select desired type.
2. Press the **4** key.
3. Rotate the **ENTER** knob to select [DELETE LIST] then push the knob.
4. Rotate the **ENTER** knob to select [Yes] then push the knob.

#### All addresses

1. Press the **4** key.
2. Rotate the **ENTER** knob to select [DELETE ALL LISTS] then push the knob.
3. Rotate the **ENTER** knob to select [Yes] then push the knob.

### 6.15.5 How to create a DSC message with registered address

1. Open the [ADDRESS BOOK] screen.
2. Rotate the **ENTER** knob to select the address to use.
3. Press the **OTHER DSC MSG** key to open the [COMPOSE MESSAGE] screen.

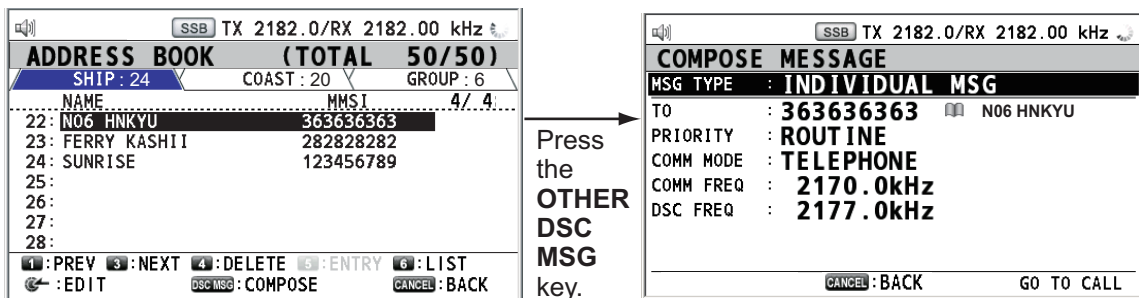

## 6.16 TX Message Preparation

For the individual, PSTN, group and test messages, you can create messages and store them in the memory for future use. You can edit, send or delete these messages. A maximum of 100 messages can be stored into the memory.

### 6.16.1 List for message files

1. Rotate the **ENTER** knob to select [DSC] on the [MENU] screen then push the knob.
2. Rotate the **ENTER** knob to select [MSG FILE] then push the knob.

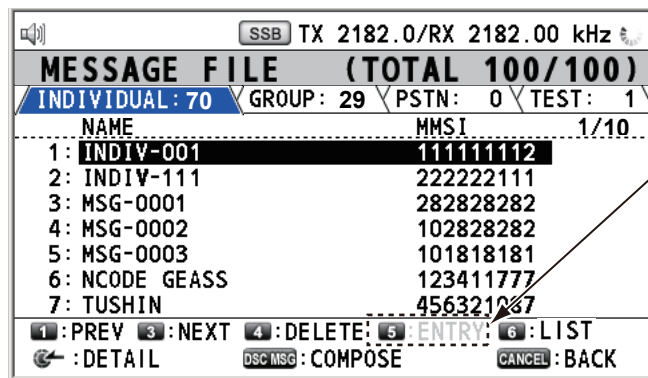

When 100 messages are registered, this is not available.

Key/knob	Function
<b>ENTER</b>	<ul style="list-style-type: none"> <li>• Move the cursor by rotating the <b>ENTER</b> knob.</li> <li>• Open the detailed information screen for the selected message file by pushing the <b>ENTER</b> knob (see the following "Detailed information screen for message files").</li> </ul>
<b>CANCEL</b>	Return to the [MENU] screen.
<b>1</b>	Go to the previous page.
<b>3</b>	Go to the next page.
<b>4</b>	Delete message files (see paragraph 6.16.8).
<b>5</b>	Open the [MESSAGE FILE ENTRY] screen.
<b>6</b>	Switch the message type. Each press changes the type continuously (INDIVIDUAL → GROUP → PSTN → TEST → INDIVIDUAL →...).

**Detailed information screen for message files**

Rotate the **ENTER** knob to select the message file desired on the [MESSAGE FILE] list then push the knob. The detailed information screen for the selected message file appears as shown right.

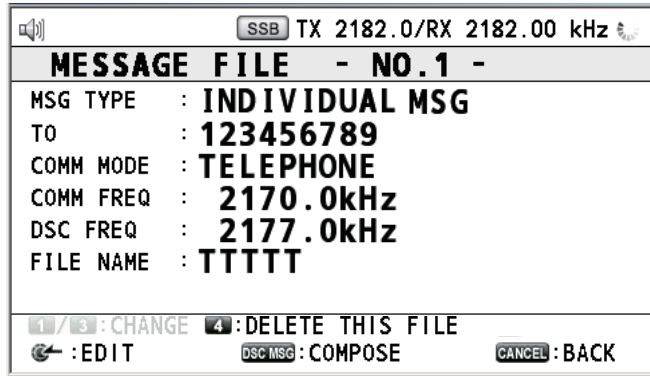

Several functions can be done from this screen.

- **1** key: Go to the detailed information screen for the previous message file.
- **3** key: Go to the detailed information screen for the next message file.
- **4** key: Delete the selected message file. The following message appears on the screen.  
Rotate the **ENTER** knob to select [Yes] then push the knob.

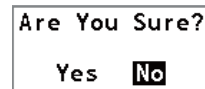

**6.16.2 Individual calls**

1. Open the [MESSAGE FILE] list.
2. Press the **5** key to open the [MESSAGE FILE ENTRY] screen.

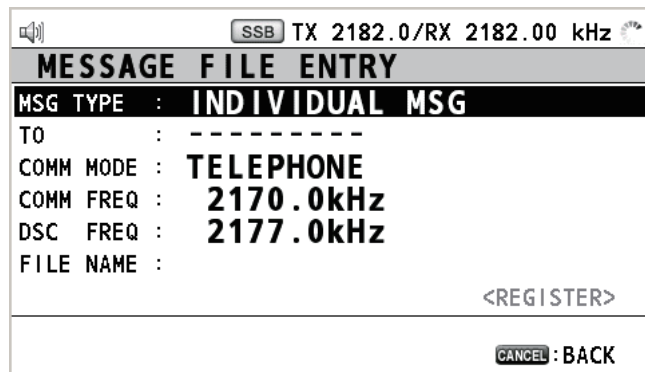

3. With [MSG TYPE] selected, push the **ENTER** knob.



4. Rotate the **ENTER** knob to select [INDIVIDUAL MSG] then push the knob.
5. With [TO] selected, push the **ENTER** knob.
6. Rotate the **ENTER** knob to select [DIRECT INPUT] or [ADDRESS BOOK DATA] then push the knob.  
[ADDRESS BOOK DATA]: Select an MMSI from the [ADDRESS BOOK] (see section 6.15) then push the **ENTER** knob.  
[DIRECT INPUT]: Enter the MMSI of coast station or ship station with the numeric keys then push the **ENTER** knob.
7. With [COMM MODE] selected, push the **ENTER** knob.
8. Rotate the **ENTER** knob to select the communication mode then push the knob.
9. Rotate the **ENTER** knob to select [DSC FREQ] then push the knob.

10. Rotate the **ENTER** knob to select DSC frequency referring to "How to set DSC frequency" on page 5-3 then push the knob. The communication frequency changes in conjunction with DSC frequency. If you change the communication frequency, go to step 11. If not, go to step 13.
11. Rotate the **ENTER** knob to select [COMM FREQ] then push the knob.



12. Set the communication frequency referring to "How to set working channel, frequency" on page 5-4 then push the **ENTER** knob.
13. Rotate the **ENTER** knob to select [FILE NAME] then push the **ENTER** knob.

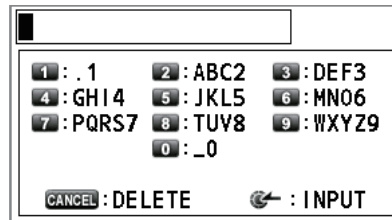

14. Enter the file name (max. 20 letters) with the numeric keys.
15. With [REGISTER] selected, push the **ENTER** knob.

### 6.16.3 Group calls

1. Open the [MESSAGE FILE] list.
2. Press the **5** key to open the [MESSAGE FILE ENTRY] screen.
3. With [MSG TYPE] selected, push the **ENTER** knob.
4. Rotate the **ENTER** knob to select [GROUP MSG] then push the knob.
5. With [TO] selected, push the **ENTER** knob.
6. Rotate the **ENTER** knob to select [DIRECT INPUT] or [ADDRESS BOOK DATA] then push the knob.  
 [ADDRESS BOOK DATA]: Select an MMSI from the [ADDRESS BOOK] (see section 6.15) then push the **ENTER** knob.  
 [DIRECT INPUT]: Enter group MMSI (eight digits) with the numeric keys then push the **ENTER** knob.
7. With [COMM MODE] selected, push the **ENTER** knob.
8. Rotate the **ENTER** knob to select [TELEPHONE] or [NBDP-FEC] then push the knob.
9. Rotate the **ENTER** knob to select [DSC FREQ] then push the knob.
10. Rotate the **ENTER** knob to select DSC frequency referring to "How to set DSC frequency" on page 5-3 then push the knob. The communication frequency changes in conjunction with DSC frequency. If you change the communication frequency, go to step 11. If not, go to step 13.
11. Rotate the **ENTER** knob to select [COMM FREQ] then push the knob.
12. Set the communication frequency referring to "How to set working channel, frequency" on page 5-4 then push the **ENTER** knob.
13. With [FILE NAME] selected, push the **ENTER** knob.
14. Enter the file name (max. 20 letters) with the numeric keys.
15. With [REGISTER] selected, push the **ENTER** knob.

### 6.16.4 PSTN calls

1. Open the [MESSAGE FILE] list.
2. Press the **5** key to open the [MESSAGE FILE ENTRY] screen.
3. With [MSG TYPE] selected, push the **ENTER** knob.
4. Rotate the **ENTER** knob to select [PSTN MSG] then push the knob.
5. With [TO] selected, push the **ENTER** knob.
6. Rotate the **ENTER** knob to select [DIRECT INPUT] or [ADDRESS BOOK DATA] then push the knob.  
[ADDRESS BOOK DATA]: Select an MMSI from the [ADDRESS BOOK] (see section 6.15) then push the **ENTER** knob.  
[DIRECT INPUT]: Enter MMSI of coast station (seven digits) with the numeric keys then push the **ENTER** knob.
7. With [TEL No.] selected, push the **ENTER** knob.
8. Enter the telephone no. (up to 16 digits) with the numeric keys then push the **ENTER** knob.
9. With [DSC FREQ] selected, push the **ENTER** knob.
10. Rotate the **ENTER** knob to select DSC frequency referring to "How to set DSC frequency" on page 5-3 then push the knob.
11. With [FILE NAME] selected, push the **ENTER** knob.
12. Enter the file name (max. 20 letters) with the numeric keys.
13. With [REGISTER] selected, push the **ENTER** knob.

### 6.16.5 Test call

1. Open the [MESSAGE FILE] list.
2. Press the **5** key to open the [MESSAGE FILE ENTRY] screen.
3. With [MSG TYPE] selected, push the **ENTER** knob.
4. Rotate the **ENTER** knob to select [TEST MSG] then push the knob.
5. With [TO] selected, push the **ENTER** knob.
6. Rotate the **ENTER** knob to select [DIRECT INPUT] or [ADDRESS BOOK DATA] then push the knob.  
[ADDRESS BOOK DATA]: Select an MMSI from the [ADDRESS BOOK] (see section 6.15) then push the **ENTER** knob.  
[DIRECT INPUT]: Enter the MMSI where to send the test message with the numeric keys then push the **ENTER** knob.
7. With [DSC FREQ] selected, push the **ENTER** knob.

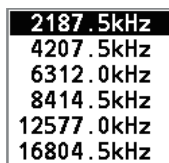

8. Rotate the **ENTER** knob to select DSC frequency desired then push the knob.
9. With [FILE NAME] selected, push the **ENTER** knob.
10. Enter the file name (max. 20 letters) with the numeric keys.
11. With [REGISTER] selected, push the **ENTER** knob.

### 6.16.6 How to edit prepared messages

1. Open the [MESSAGE FILE] list.
2. Rotate the **ENTER** knob to select the message file to edit then push the knob.
3. Push the **ENTER** knob to open [MESSAGE FILE EDIT] screen.

4. Rotate the **ENTER** knob to select the item to edit then push the knob.
5. Change the setting accordingly.
6. Rotate the **ENTER** knob to select [REGISTER] then push the knob.

7. Rotate the **ENTER** knob to select [Yes] then push the knob.

### 6.16.7 How to send prepared messages

#### How to send without modification

1. Open the [MESSAGE FILE] list.
2. Rotate the **ENTER** knob to select the message file desired then press the **OTHER DSC MSG** key.
3. Rotate the **ENTER** knob to select [GO TO CALL] then push the knob.

#### Edit before sending

Follow the procedure in paragraph 6.16.6 and do the above procedure "How to send without modification".

### 6.16.8 How to delete prepared messages

#### Individual prepared message

Open the [MESSAGE FILE] list then follow the applicable procedure below.

1. Rotate the **ENTER** knob to select the file to delete then press the **4** key.
2. With [DELETE SELECTION] selected, push the **ENTER** knob.
3. Rotate the **ENTER** knob to select [Yes] then push the knob.

**Prepared messages by type**

1. Press the **6** key several times to select the desired type.
2. Press the **4** key.
3. Rotate the **ENTER** knob to select [DELETE LIST] then push the knob.
4. Rotate the **ENTER** knob to select [Yes] then push the knob.

**All prepared messages**

1. Press the **4** key.
2. Rotate the **ENTER** knob to select [DELETE ALL LISTS] then push the knob.
3. Rotate the **ENTER** knob to select [Yes] then push the knob.

## 6.17 How to Set the AUTO ACK Details

The acknowledgment message can be sent automatically when you receive an individual message or a PSTN message. You can also enable or disable it for position, polling and test messages. For PSTN, position and polling messages, automatic acknowledgment is disabled with an active DSC session.

**Note 1:** For individual message, the automatic acknowledgment is automatically disabled, as required by law, when an RX call contains an error.

**Note 2:** For individual message, the auto acknowledgment message can not be sent when there are RT and/or DSC sessions.

1. Rotate the **ENTER** knob to select [DSC] on the [MENU] screen then push the knob.
2. Rotate the **ENTER** knob to select [ACK SETTINGS] then push the knob.

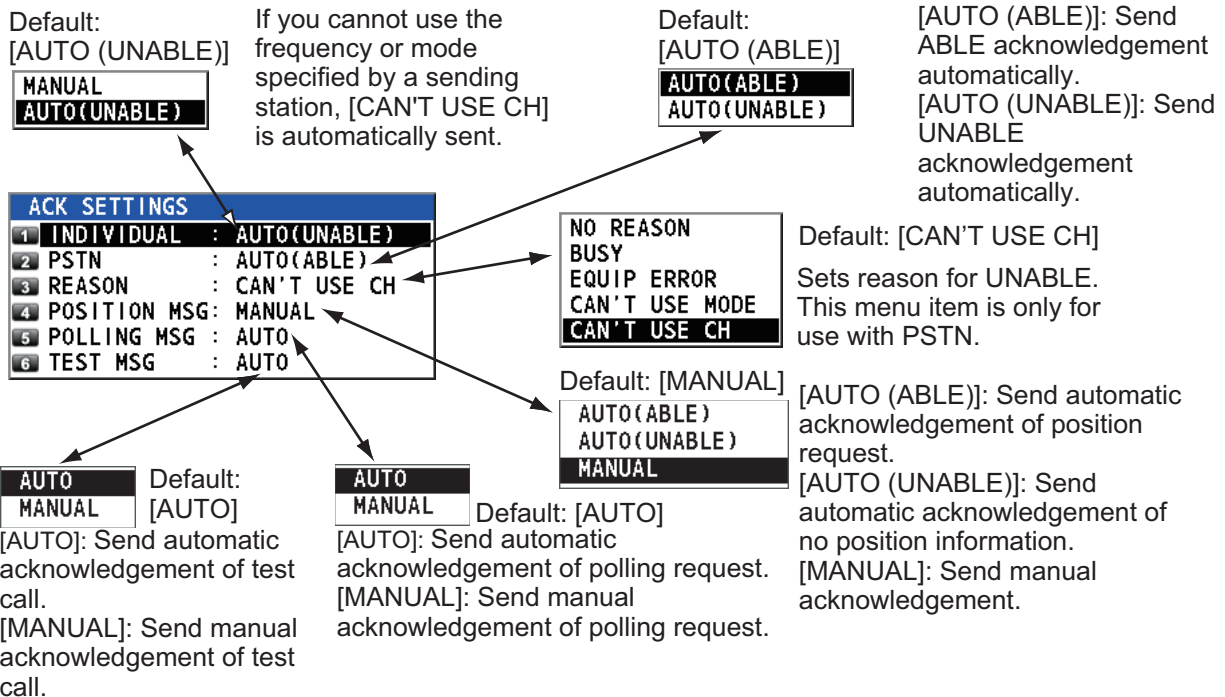



## 6.18 Special Messages

Permission to transmit NEUTRAL CRAFT and MEDICAL TRANSPORT is enabled or disabled as follows:

1. Rotate the **ENTER** knob to select [DSC] on the [MENU] screen then push the knob.
2. Rotate the **ENTER** knob to select [SPECIAL MSG] then push the knob.

SPECIAL MSG	
1	NEUTRAL : UNABLE
2	MEDICAL : UNABLE

3. Rotate the **ENTER** knob to select [NEUTRAL] or [MEDICAL] then push the knob.
4. Rotate the **ENTER** knob to select [ABLE] or [UNABLE] then push the knob.

## 6.19 How to Set Scan Frequencies

The [ROUTINE/DISTRESS SCAN] menus determine which DSC routine and distress frequencies to scan. Follow the instructions below to select/deselect DSC routine and distress frequencies to scan.

### Routine frequencies

1. Rotate the **ENTER** knob to select [DSC] on the [MENU] screen then push the knob.
2. Rotate the **ENTER** knob to select [ROUTINE SCAN] then push the knob.

ROUTINE SCAN FREQ SETUP	
SSB TX 2170.0/RX 2170.00 kHz	
SCAN1 :	RX 2177.0 kHz
SCAN2 :	OFF
SCAN3 :	OFF
SCAN4 :	OFF
SCAN5 :	OFF
SCAN6 :	OFF
← : SELECT      CANCEL : BACK	

3. Rotate the **ENTER** knob to select [SCAN1] (2, 3, 4, 5 or 6) then push the knob.

OFF
2 MHz
4 MHz
6 MHz
8 MHz
12 MHz
16 MHz
18 MHz
22 MHz
25 MHz

4. Rotate the **ENTER** knob to select frequency band then push the knob.
5. Rotate the **ENTER** knob to select frequency desired then push the knob.  
 [INTL]: International channels  
 [LOCAL1/LOCAL2]: Local channels  
 [DIST]: Distress channels

## 6. MENU OPERATION

**Note:** Distress frequencies can be stored on the routine frequency memory. This is convenient for backing up the watch-keeping receiver.

### **Distress, urgency and safety frequencies**

1. Rotate the **ENTER** knob to select [DSC] on the [MENU] screen then push the knob.
2. Rotate the **ENTER** knob to select [DISTRESS SCAN] then push the knob.

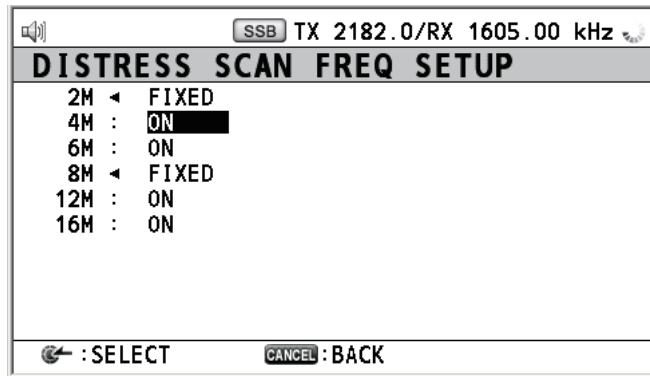

3. Rotate the **ENTER** knob to select frequency band then push the knob.

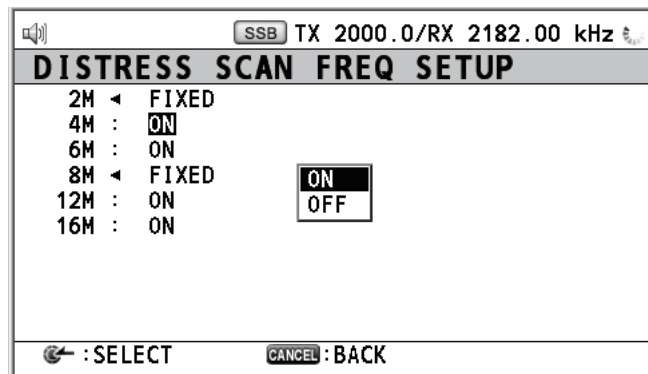

4. Rotate the **ENTER** knob to select [ON] or [OFF] as appropriate then push the knob.

**Note:** Regulations require that 2 MHz and 8 MHz and one more DSC distress frequency should be watched continuously. 2 MHz and 8 MHz cannot be turned off. Maximum three bands can be turned off.

## 6.20 Sound Setting

The [AUDIO] menu lets you set the volume for the following items:

- Key click on (setting: [1] - [3]) or off (setting: [0]) (Two beeps sound when a key which is inoperative in the ON mode (setting: [1] - [3]) is pressed.)
- Speaker on or off with off hook for handset
- Volume of the receiving alarm for the safety and routine messages
- Turn sound alarm on or off for the distress alarm received from a ship in distress which is more than 500 NM from your ship.

Rotate the **ENTER** knob to select [AUDIO] on the [MENU] screen then push the knob.

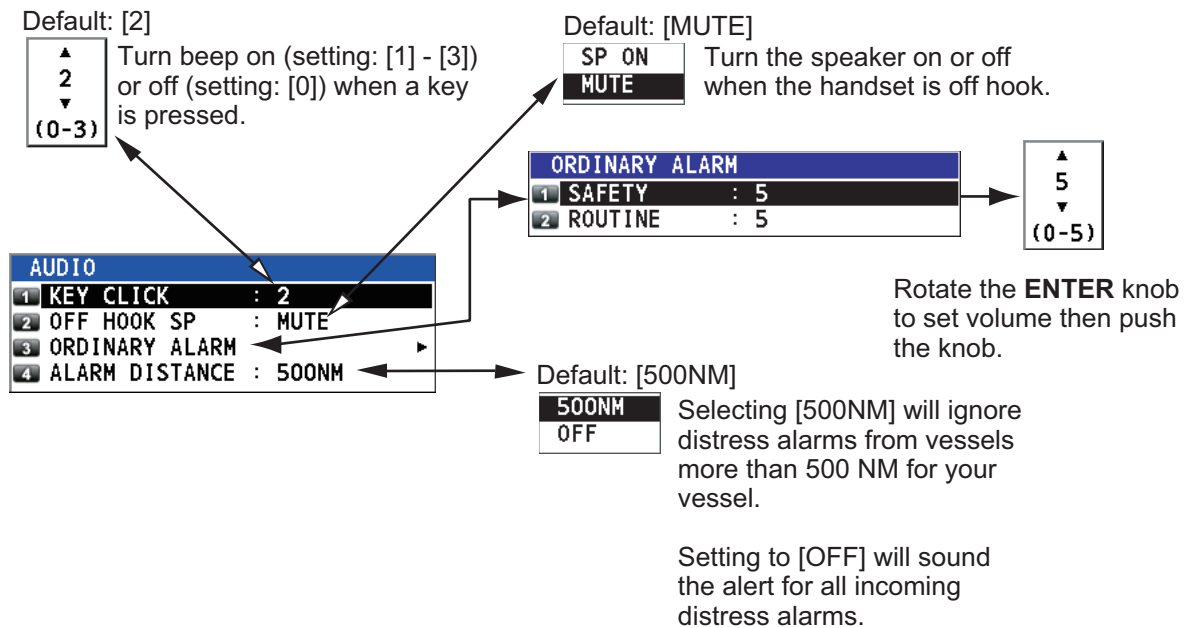

## 6.21 Alarm List

The [ALARM] menu shows all currently violated alarms. When an alert occurs, a pop-up message and the flashing alert icon appear on the screen. Press the **CANCEL** key to close the pop-up message and stop the flashing of the alert icon. When the alert is removed, the alert icon disappears.

Rotate the **ENTER** knob to select [ALARM] on the [MENU] screen then push the knob. The following screen appears.

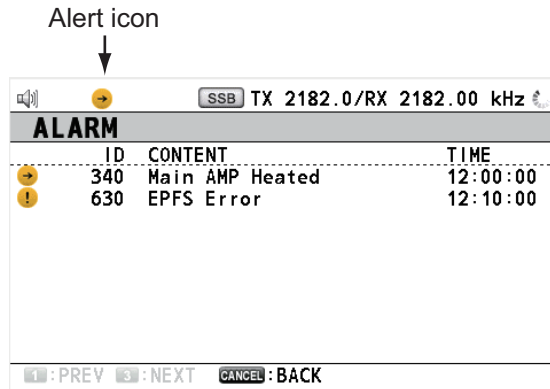

There are 14 kinds of alerts: TX PLL UNLOCK, RX PLL UNLOCK, WR1 PLL UNLOCK, WR2 PLL UNLOCK, Ship's Main Failure, VC Error, Lost Position, EPFS Error, EPFS Offline Error, Printer Error, Communication Error, Main AMP Heated, Natural Tune, TUNE NG. For details of alerts, see "ALERT LIST AND CODES" on page AP-33.

Alerts are displayed in the order of occurrence. An alert is deleted from the list when the cause for the alert is removed.

# 7. NBDP SYSTEM OVERVIEW

---

## 7.1 How to Turn on the NBDP System

Turn on the terminal unit and the printer with their respective power switches.

TERMINAL UNIT IB-585

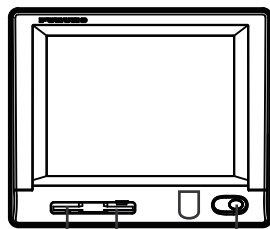

The power switch backlight lights in green during power-on.

Power switch  
SD card drive  
USB connector (Connect the keyboard here.)

PRINTER PP-520

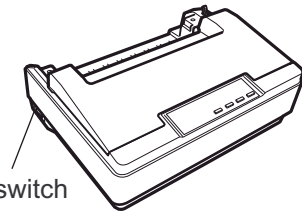

Power switch

**Note 1:** To power on the system, turn on the control unit then turn on the NBDP terminal unit.

**Note 2:** The printer PP-520 prints messages. Refer to its operator's manual for operation.

## 7.2 Description of Equipment

### 7.2.1 Terminal unit

The terminal unit is a visual display incorporating an SD card drive.

When the terminal unit is turned on, the communication status screen, shown on the next page, appears. This is where all phases of telex communications begin.

## 7. NBDP SYSTEM OVERVIEW

```

1:File 2:Edit 3:Operate 4:Window 5:Station 6:System 7:WRU 8:HR 9:Over 10:Break
----- 10-Apr-2012 15:10:30 UTC ---- Caps Eng
Station Name      :
Frequency (T/R)   :      /      (kHz)  Comm Mode : AUTO
Comm Status       :  Connect Send Lock Error
Sending Volume    :      (%)      Error : 0      ARQ Time : 0(sec)
-----

```

The cursor at the left bottom of the screen flashes during operation.

Date and time: day-month-year, hour: min: sec (see page 7-8.)

```

----- 10-Apr-2012 15:10:30 UTC ---- Caps Eng
Station Name      :
Frequency (T/R)   :      /      (kHz)  Comm Mode : AUTO
Comm Status       :  Connect Send Lock Error
Sending Volume    :      (%)      Error : 0      ARQ Time : 0(sec)
-----

```

Caps: On caps lock  
No indication: Not on caps lock

Eng: English mode  
Rus: Russian mode  
(see page 7-2)

Time system (see page 7-8)

Ship's name registered in the station list  
(see section 8.3).

ID no. for the called party (see paragraph 8.1.2)

```

----- 10-Apr-2012 15:10:30 UTC ---- Caps Eng
Station Name      :
Frequency (T/R)   :      /      (kHz)  Comm Mode : AUTO
Comm Status       :  Connect Send Lock Error
Sending Volume    :      (%)      Error : 0      ARQ Time : 0(sec)
-----

```

Communication mode  
(see paragraph 10.4)

TX frequency (1605.0 - 27500.0 kHz)  
(see section 10.1)

RX frequency (0.1 - 29999.9 kHz)  
(see section 10.1)

The current communication status is highlighted.

Connect: When connecting

Send: When your station is an information sending station

Lock: When synchronization is completed

Error: When required resending in ARQ mode

```

----- 10-Apr-2012 15:10:30 UTC ---- Caps Eng
Station Name      :
Frequency (T/R)   :      /      (kHz)  Comm Mode : AUTO
Comm Status       :  Connect Send Lock Error
Sending Volume    :      (%)      Error : 0      ARQ Time : 0(sec)
-----

```

Communication time  
in ARQ mode

Percentage of message transmitted  
(see page 10-4)

Number of errors in ARQ mode

*Communication status screen*

### **Russian mode**

The terminal unit is fitted with both English and Russian modes. Select the desired mode as below:

“English-mode”: Turn on the terminal unit while pressing the **E** key.

“Russian-mode”: Turn on the terminal unit while pressing the **R** key.

This mode is stored.

In “Russian-mode”, there are two input shift status; “English-shift” and “Russian-shift”.

In the “Russian-shift” status, the alphabet keys are used as Cyrillic keys.

**Note 1:** To switch between Russian and English input, press the **Alt** key while holding down the **Shift** key. (This is available in Russian mode only.) “Eng” or “Rus” appears on the top right of the screen. This shift status is not stored. When you turn on the power next time, you reset the shift status as necessary.

**Note 2:** The comma and period can not be entered in the “Russian-shift” status. To enter these characters, switch to the “English-shift” status.

**Note 3:** “Ё” and “Ъ” can not be entered in “Russian-mode”. “4” is replaced with “4” in NBDP communication.

**Note 4:** To select “A” in menu operation, press the **A** key in English (not “A” in Russian).

## 7.2.2 How to adjust of the brilliance of the terminal unit

To adjust the brilliance, press the **Alt** key while pressing the **F6** key to lower the brilliance; the **F7** key to raise it. 11 levels of brilliance are available.

**Alt + F6** key: Lowers the brilliance.

**Alt + F7** key: Raises the brilliance.

## 7.2.3 How to switch to night mode

1. Press **Alt + F8** to switch from the current color mode to [Preset3] (Night).
2. Press **Alt + F8** again to switch to [Preset1] (Original).

**Note:** The above procedure is based on default settings. If the colors for the presets have been changed for [Preset3], it is no longer Night mode. To restore the Night mode colors, see section 8.5 for the default color settings and how to change the settings.

## 7.2.4 Keyboard

The terminal unit is operated from the keyboard. Operation is simplified by the use of menus which you access by pressing a function key, labeled F1-F10 at the top of the keyboard. The figures below show the function menus and their corresponding function keys.

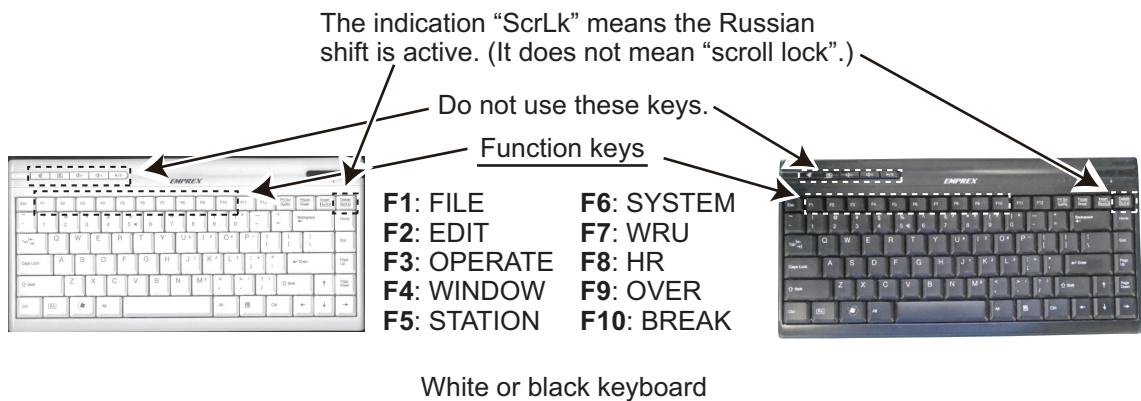

**Note 1:** The correct letters may not be entered when connecting a keyboard except the supplied one.

**Note 2:** Both Russian and English input are available in the Russian mode. Put the keytop label supplied on the keyboard during the Russian mode.

**Note 3:** The carriage-return and line-feed codes "CR LF" are automatically sent with pressing the **Enter** key during NBDP communication. Press the → or ↓ key if you want to send only "CR" or "LF".

**Note 4:** "Letter Shift" and "Figure Shift" are automatically inserted if necessary. If you want to send them purposely, press the following keys:

- "Letter Shift": **Ctrl + Shift + L**
- "Figure Shift": **Ctrl + Shift + F**
- "NOINF" ("Cyrillic Shift" in Russian mode): **Ctrl + Shift + R**

**Note 5:** Do not connect or disconnect the keyboard during operating the terminal unit.

## 7.3 Encoding Setting

If changing the encoding setting, you can assign a specific key to a local character code. Contact your dealer about changing of the encoding setting.

Encoding setting	" [ " key	" ] " key	"   " key
Normal (default)	-	-	-
Norway	Æ	Å	ϕ *1
Sweden	Ä	Å	Ö
UK	@*2	%*3	£

\*1: The appearance of " ϕ " is not case-sensitive.

\*2: To send the character "@" in UK encoding setting, press the "[ " key assigned "@" instead of **Shift + 2**.

\*3: To send the character "%" in UK encoding setting, press the "]" key assigned "%" instead of **Shift + 5**.



## 7.4 Function Keys, Menu Operation

The function keys at the top of the keyboard control most of operations through a menu system.

### 7.4.1 Menu conventions

#### Reverse highlighting

The cursor-selected menu item is displayed with white characters on a black background.

#### Underline

The underline shows the currently selected option. In the figure below, for example, [ARQ], [Channel] and [ON] are underlined.

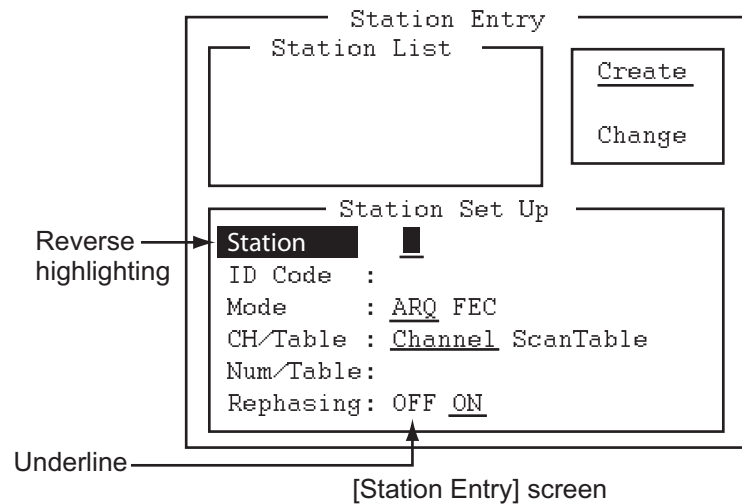

### 7.4.2 Menu overview

#### Menu selection

Press a function key to open a menu. To display the [File] menu, for example, press the function key F1.

#### Selection of menu items and options

Press a numeric or alphabet key to select a menu item. You can also select a menu item to press the ↑ or ↓ key then press the **Enter** key. Menu options can be selected by the ← or → key. After selecting an option, press the **Enter** key to register your selection.

#### How to close the menu

Press and hold down the **Es** key for over a second to close the menu.



### 7.4.3 Function key description

#### Function key F1: [File] menu

The [File] menu is where you create, open, save and print telex messages. Floppy disks or SD cards are also formatted by this menu.

File	
1:	New
2:	Open
3:	Close
-----	
4:	Delete
-----	
5:	Rename
-----	
6:	Real Time Printing
7:	File to Print
8:	Cancel Printing
-----	
9:	Clear Buffer
-----	
0:	SD Card Format
A:	Remove SD Card
-----	
B:	New Macro

- 1:** Open a new untitled window.
- 2:** Open files saved on floppy disks or SD cards.
- 3:** Close files with saving or discarding.
- 4:** Delete files on floppy disks or SD cards.
- 5:** Rename files on floppy disks or SD cards.
- 6:** Turn real time printing on or off.
- 7:** Print files on floppy disks or SD cards.
- 8:** Stop printing and clear the print buffer.
- 9:** Clear the communication buffer.
- 0:** Format an SD card.
- A:** Execute this menu before removing an SD card.
- B:** Open a macro window.

#### Function key F2: [Edit] menu

The [Edit] menu provides a full line of editing features.

Edit	
1:	Undo
-----	
2:	Cut
3:	Copy
4:	Paste
-----	
5:	Select All
-----	
6:	Search
7:	Replace
-----	
8:	Goto Top
9:	Goto Bottom
0:	Goto Line
-----	
A:	Change Text

- 1:** Cancel the last change (cut, copy or paste).
- 2:** Remove the selected text and store it in the paste buffer. (Previous text in the paste buffer is cleared.)
- 3:** Copy the selected text and store it in the paste buffer. (Previous text in the paste buffer is cleared.)
- 4:** Insert the text stored in the paste buffer at the current location of the cursor.
- 5:** Select the entire current file for cut or copy.
- 6:** Search a word or a character string.
- 7:** Replace a word with a different word or character string.
- 8:** Put the cursor to the top line of the current file.
- 9:** Put the cursor to the last line of the current file.
- 0:** Move the cursor to the desired line in the current file.
- A:** Switch between the display window 1 and 2.

**Function key F3: [Operate] menu**

The [Operate] menu mainly controls transmission and reception.

Operate	
1: Call Station	
2: Macro Operation	
-----	
3: File to Send	
4: Cancel Sending	
-----	
5: Scan (Start/Stop)	
-----	
6: Manual Reception	
-----	
7: Timer Operation	
-----	
8: Manual Calling	
9: Set Frequency	
0: Set Channel	

- 1: Select a station on the station list.
- 2: Start macro operation. For details, see section 10.10.
- 3: Select a file then transmit it.
- 4: Stop sending a file.
- 5: Start/stop frequency scanning.
- 6: Select communication mode for reception; AUTO, ARQ, FEC.
- 7: Enable timer programming.
- 8: Set TX mode and subscriber's ID number and start manual calling.
- 9: Set TX and RX frequencies and start waiting for reception.
- 0: Set ITU or user channel and start waiting for reception.

**Function key F4: [Window] menu**

The [Window] menu lets you display the corresponding data of the window below.

Window	
1: Calendar	
-----	
2: Distress Frequency Table	
-----	
3: Screen Saver	OFF ON

- 1: Display desired calendar month and year. To change year or month, select item with the ↑ or ↓ key and change setting with the ← or → key.
- 2: Display all distress frequencies (see the following table).
- 3: Turn on or off the screen saver function. For details, see section 8.6.

Distress Frequencies						
Telephone (kHz):	2182.0	4125.0	6215.0	8291.0	12290.0	16420.0
-----						
NBDP (kHz) :	2174.5	4177.5	6268.0	8376.5	12520.0	16695.0
-----						
DSC (kHz) :	2187.5	4207.5	6312.0	8414.5	12577.0	16804.5

**Function key F5: [Station] menu**

The [Station] menu provides for storage of stations, timer program setup, user channel setup, and entry of various ID codes.

Station
1: Station Entry
-----
2: Timer Operation Entry
-----
3: Scan Entry
-----
4: Answerback Code Entry
-----
5: Group ID Entry (4/5 digit)
6: Group ID Entry (9 digit)
7: Select ID Entry (4/5 digit)
8: Select ID Entry (9 digit)

- 1: Register stations.
- 2: Register timer programs.
- 3: Register scan groups for scanning.
- 4: Register own ship's answerback code.
- 5: Register own ship's group ID code (4 or 5 digits).
- 6: Register own ship's group ID code (9 digits).
- 7: Register own ship's selective ID code (4 or 5 digits).
- 8: Register own ship's selective ID code (9 digits).

**Function key F6: [System] menu**

The [System] menu is mainly for use by technicians and contains diagnostic tests. To change settings, select [Change] from the item [Setup] and operate the arrow keys to select item and option. Press the **Enter** key to register the selection and close the menu.

System	
Setup	Lock Change Default
-----	-----
Slave Delay	12 msec (10 - 50 msec)
-----	-----
TX/RX MSG Save	<u>OFF</u> ON
Edit before Sending	<u>OFF</u> ON
TX Power	<u>HIGH</u> MID LOW
Header/Footer	<u>OFF</u> ON
-----	-----
Time System	OFF <u>UTC</u> SMT JST
Date & Time	10-Apr-2012 10:00:00
Window Color	
Self Test	

Each option underlined is the default setting.

Menu item	Function
[Setup]	Lock, change settings, restore default system settings.
[Slave Delay]	<p>Set the length of the slave delay timing from the end of RX to the start of TX in the ARQ mode. The default setting is suitable in most cases. This item cannot be adjusted by the user.</p> <p>The diagram illustrates the timing sequence in ARQ mode. It shows an 'ARQ mode signal sequence' followed by a '3 char. RX' block. A horizontal line with a double-headed arrow below it indicates the 'Slave Delay Timing' period, which starts at 'RX end' and ends at 'TX start'. Following this delay is an 'ACK signal' block, also labeled as '3 char. RX'.</p>

Menu item	Function
[TX/RX MSG Save]	Turn on to automatically save incoming and outgoing messages to a floppy disk or a SD card. "Log" appears at the top of the screen when on.
[Edit Before sending]	[OFF] transmits key operation one by one. [ON] transmits message only when the <b>Enter</b> key is pressed after confirming text typed.
[TX POWER]	Change output power during transmission. ([HIGH], [MID], [LOW] (for FS-1575/2575), [LOW1] (for FS-5075), [LOW2] (for FS-5075))
[Header/Footer]	Turn on or off the indication of header and footer. When starting transmission, display time & date for starting transmission, MMSI for communication party, TX and RX frequencies. When ending transmission, display time & date for ending transmission.
[Time System]	Select time system. [OFF]: No time indication, [UTC]: Coordinated universal time, [SMT]: Local time, [JST]: Japan standard time
[Time & Date]	Enter date and time manually. If a navigation device is connected, the time is automatically set when the power is turned on or whenever the time system is switched. Manual entry takes priority over automatic entry. This item cannot be adjusted when using [UTC] or [JST].
[Window Color]	Select display colors. For details, see section 8.5.
[Self Test]	Start diagnostic test.

#### **Function key F7: WRU (Who Are You?)**

In the ARQ mode, request other station's answerback code.

#### **Function key F8: HR (Here Is)**

In the ARQ mode, send your ship's answerback code.

#### **Function key F9: OVER**

In the ARQ mode, switch the direction of traffic; the information receiving station switches to the information sending station, the information sending station switches to the information receiving station.

#### **Function key F10: Break**

During communication: Disconnect the line.

During reception mode: Goes to the standby mode.

**Note:** For NBDP activated by the DSC function, select [QUIT] option on the control panel to cancel reception mode and go to the standby mode.

## 7. NBDP SYSTEM OVERVIEW

This page is intentionally left blank.

# 8. NBDP PREPARATIONS

---

This chapter provides the procedures necessary for preparing the NBDP terminal unit. For automatic telex, you need to register the following:

- Your ship's ID and answerback codes mandatory
- Stations
- Timer programs
- Scan channel groups
- User channels

## Available channels

The channels available with the IB-585 are shown below.

- Preset channels  
Use the four or five digits channel number listed in the "MF band telex frequency table" (page AP-11) or "ITU Telex frequency table" (page AP-12 to AP-15).
- User channels  
A user channel consists of four or five digits. For IB-585, the user channels are set by the transceiver unit. See section 6.2 for how to register user channels.

The functions related to NBDP are shown below.

- Station list (section 8.2)
- Scan Channel Group (section 8.2)
- Manual Calling (section 10.1)

## 8.1 Registration of Answerback & ID Codes

Enter your ship's answerback and ID codes as shown below.

**Note:** The answerback and ID codes cannot be changed once entered; be sure to correctly enter the codes.

### 8.1.1 How to register answerback code

1. Press the function key **F5** then the **4** key to open the [Answerback Code Entry] screen.

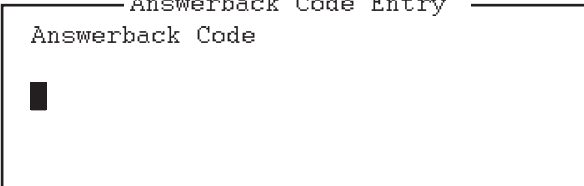

```
Answerback Code Entry
Answerback Code
█
```

2. Enter your ship's answerback code (numbers, space, 4 capital letters, space, X) then press the **Enter** key. The prompt "OK/Cancel" asks for confirmation of the data.

Example of answerback code: 123456789 FURU X.

## 8. NBDP PREPARATIONS

3. If the code is correct, press the **Enter** key again. For final confirmation of the data, the "Caution" shown in the illustration below appears.

Answerback Code Entry

Answerback Code

123456789 FURU X

OK

Cancel

Caution

Confirm the 'CODE' before pressing ENTER key.

You cannot change the CODE once it has been entered.

*Message for confirmation of code entered*

4. If the code is correct, press the **Enter** key again.

### 8.1.2 How to register ID codes

1. Press the function key **F5** then the **5**, **6**, **7** or **8** key to enter the Group ID Code (4 or 5 digits), Group ID Code (9 digits), Select ID Code (4 or 5 digits) or Select ID Code (9 digits), respectively.

Select ID Entry

Select ID Code (4/5)

■

2. Enter Group ID or Select ID then press the **Enter** key. A prompt asks for confirmation of the data.
3. If the ID is correct, press the **Enter** key. For final confirmation of the data, the "Caution" shown in the illustration below appears.

Select ID Entry

Select ID Code (4/5)

12345

OK

Cancel

Caution

Confirm the 'CODE' before pressing ENTER key.

You cannot change the CODE once it has been entered.

*Message for confirmation of code entered*

4. If the ID is correct, press the **Enter** key again.

## 8.2 Station List

The station list stores up to 50 stations, one frequency pair (RX and TX) per station. For stations which have more than one frequency pair, you can add a suffix to the station name to denote multiple frequency pairs. For example, station name FURUNO followed by -1, -2, -3, etc. for each frequency pair required.



## 8.2.1 How to register stations

1. Press the function key **F5** then the **1** key to open the [Station Entry] screen. On the right side of the screen, [Create] and [Change] are shown.

2. If [Create] is not underlined, press the →, → and **Enter** keys to underline it.
3. With [Station] selected, enter station name using up to 18 characters.
4. Press the ↓ key to select [ID Code]. Enter station ID code.
5. Press the ↓ key to select [Mode]. Select either communication mode with the ← or → keys.  
[ARQ]: Automatic Retransmission Request  
[FEC]: Forward Error Correction
6. Press the ↓ key to select [CH/Table]. Select [Channel] or [ScanTable] with the → or ← key.
7. Press the ↓ key to select [Num/Table].  
If you selected [Channel] at step 6, enter ITU channel number (see Appendix 2) or User channel number. Go to step 10.  
If you selected [ScanTable] at step 6, press the → key to show the scan group list registered. For the scan group, refer to section 8.4.

*Example window for Scanning Group List*

8. Select a scan group name by using the ↓ or ↑ key then press the **Enter** key.
9. Press the ↓ key to select [Rephasing]. Select [ON] or [OFF].  
**Note:** The default setting is [ON]. Select [ON] under normal use.
10. Press the **Enter** key. The prompt [OK/Cancel] asks for verification of data.

11. The station name entered at step 3 appears at the [Station List] window. If the data is correct, press the **Enter** key. (To cancel entry, press the ↓ key to select [Cancel] then press the **Enter** key. Data entered are erased.)

## 8. NBDP PREPARATIONS

12. To register other stations, press the **Enter** key twice then repeat steps 3 through 11.
13. Press the ↓ key. Check data on the [Station List] for correctness. The stations displayed in reverse video on the [Station List] are displayed on [Station Set Up].
14. Press the **Esc** key to quit.

**Note 1:** If you enter a station which already exists, the indication "Station by that name already exists. Press any key to escape." appears. Press any key to return to the [Station List]. Check the list.

**Note 2:** The station entry beginning with "DSC" is special entry which is automatically registered by DSC function.

### 8.2.2 How to edit/delete stations

1. Press the function key **F5** then the **1** key to open the [Station Entry] screen.
2. Press the ↓ key to select a station name from the [Station List].
3. Press the → key then the ↓ key to select [Change] and press the **Enter** key.
4. Do one of the following;  
Edit station: Use the ↑, ↓ and the **Backspace** keys to make corrections.  
Delete station: Erase station name with the **Backspace** key.
5. Press the **Enter** key twice.
6. Press the **Esc** key.

## 8.3 Timer Programming

A built-in timer allows you to automatically receive and transmit files. 10 timer programs can be registered. To enable timer operation, see section 10.6.

### 8.3.1 How to register timer programs

1. Press the function key **F5** then the **2** key to open the [Timer Operation Entry] screen.

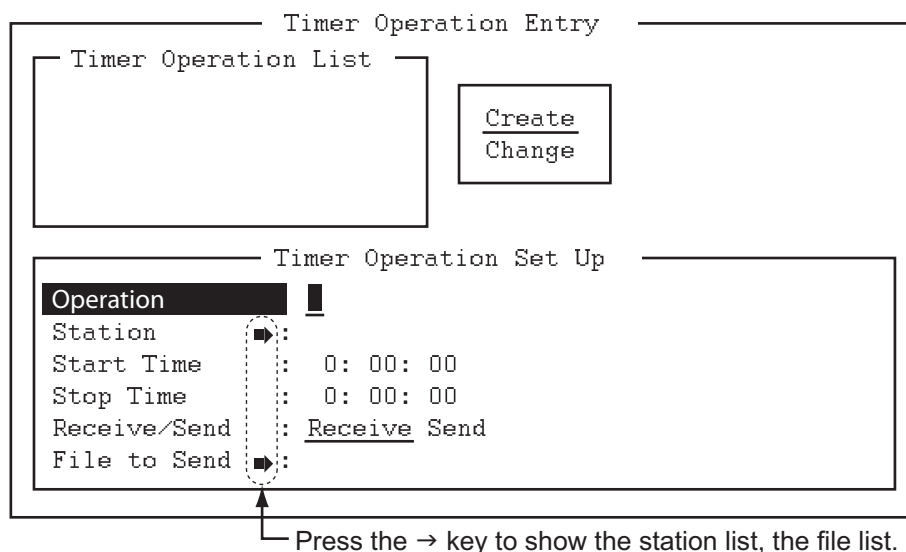

2. If [Create] is not underlined, press the →, ↑ and **Enter** keys to underline it.

3. With [Operation] selected, enter a suitable operation name on the [Operation] line. Any alphanumeric characters can be used.  
**Note:** If the operation name entered already exists, the message "Operation name already exists. Press any key to escape." appears. Press any key and change the operation name.
4. Press the ↓ key to select [Station].
5. Press the → key to display [Station List] (which you registered stations in the previous paragraph).
6. Press the ↓ or ↑ key to select a station then press the **Enter** key.
7. Press the ↓ key to select [Start Time]. Enter start time, in 24-hour notation. To have the operation start at 8:35 a.m., for example, the keying sequence would be **0 8 3 5 0 0**.
8. Press the ↓ key to select [Stop Time]. Enter stop time, in 24-hour notation.
9. Press the ↓ key to select [Receive/Send]. Select operation category; [Receive] or [Send] with the ← or → key. If you select [Send], go to step 10. For [Receive], go to step 12.
10. For [Send], insert the floppy disk or the SD card to the drive then press the → key to select [File to Send].
11. Press the → key to open the file list, select a file with the ↓ or ↑ key, then press the **Enter** key twice.
12. Press the **Enter** key. A confirmation message appears.
13. Press the **Enter** key. The operation name appears in [Timer Operation List].
14. To enter another timer program, press the **Enter** key twice and repeat steps 3 to 13.
15. Press the **Esc** key to close the menu.

### 8.3.2 How to edit/delete timer programs

1. Press the function key **F5** then the **2** key to open the [Timer Operation Entry] screen.
2. Press the ↓ key to select a timer program name from the [Timer Operation List].
3. Press the → key then the ↓ key to select [Change] and press the **Enter** key.
4. Do one of the following;  
Edit program: Use the ↓, ↑ and the **Backspace** keys to make corrections.  
Delete program: Erase operation name with the **Backspace** key.
5. Press the **Enter** key twice.
6. Press the **Esc** key.

## 8.4 Scan Channel Groups

You can store up to 10 scan groups, 20 channels per group.

The NBDP terminal unit can control radio equipment through channel scanning. In the FEC mode, the radio equipment scans a number of channels (according to your selection), stopping when a synchronous code is found. In the ARQ mode it stops when your own ID code is detected in an incoming signal. Also, in the ARQ mode, the transmitter is then tuned to the corresponding transmitter frequency, the communication link is established and the traffic is automatically exchanged. Scanning resumes once the link is disconnected.

### 8.4.1 How to register scan channel groups

1. Press the function key **F5** then the **3** key to open the [Scan Entry] screen.

Scan Entry

Scanning Group List

Create  
Change

---

Scanning Set Up

**Group Name** : █

Ch Dwell Time : 4.5 sec (2.7-4.5 sec)

Receiving Mode : AUTO ARQ FEC

Auto Search : OFF ON

---

No.	Channel	Rx Freq	Tx Freq	
1				Pass/Scan
2				Pass/Scan
3				Pass/Scan
4				Pass/Scan
5				Pass/Scan
6				Pass/Scan

↓ Press the ↓ key to scroll the screen.

2. If [Create] is not underlined, press the →, ↑ and **Enter** keys to underline it.
3. With [Group Name] selected, enter a suitable group name.
 

**Note 1:** 10 group names can be entered. If you attempt to enter more, the message "Scan group memory is full. Press any key to escape." appears. Press any key then delete unnecessary group names to enter new ones.

**Note 2:** If the group name already exists, the message "Scan group by that name already exists. Press any key to escape." appears. Press any key and change the scan group name.
4. Press the ↓ key to select [Ch Dwell Time]. Enter channel dwell time in seconds. Dwell time is the time in seconds the receiver waits on each channel in a scan group before it selects the next frequency.
5. Press the ↓ key to select [(Receiving) Mode] then select the receiving mode; [AUTO], [ARQ] or [FEC] with the ← or → key.
 

**Note:** [AUTO] is used to register a scanning group when both [ARQ] and [FEC] exist in the same Scanning Channel Group. When you select a scan group by the [Call Station] menu, the communication mode is controlled by the station entry's mode.

6. Press the ↓ key to select [Auto Search]. Select [ON] or [OFF].  
 [ON]: The radio stops scanning when it finds the strongest signal (highest S/N ratio). To find the strongest signal, the radio scans all channels, which can take some time. Therefore, use this setting where the signal propagation is poor.  
 [OFF]: The radio stops scanning on the first signal it finds. It is recommended to select [OFF] when the signal propagation is good.
7. Press the ↓ key to select line No. 1 in the [Scanning Set Up] window.
8. Enter the channel number (ITU or user channels) then press the → key to select [Scan].  
**Note:** If you enter an invalid channel, the message "Channel by that number does not exist. Press any key to escape." appears. Press any key then enter a valid channel.
9. Press the ↓ key to select line No. 2. Enter a channel number.
10. Enter other channel numbers then press the **Enter** key. A confirmation message appears.
11. Press the **Enter** key to save the data. The scanning group name is displayed in the [Scanning Group List] window.
12. To register additional scanning groups, press the **Enter** key twice then repeat steps 3 to 11.
13. Press the **Esc** key to close the menu.  
**Note 1:** An ARQ from another station continues for 56 seconds. However, you cannot receive via ARQ if the number of registered scan channels multiplied by the channel dwell time is greater than 56 seconds.  
**Note 2:** The selective FEC mode requires authentication of call ID. However, you cannot receive via the selective FEC mode if the Call ID is not received with the frequency for scan detention time. If you might be called via the selective FEC mode, wait to receive the call on a single frequency, which you can set with the [Set Frequency] in the [Operate] menu.

### 8.4.2 How to edit/delete scan channel groups

1. Press the function key **F5** then the **3** key to open the [Scan Entry] screen.
2. Press the ↓ key to select scan group name from the [Scanning Group List].
3. Press the → key then the ↓ key to select [Change] and press the **Enter** key.
4. Press the ↓ key to place the cursor on the field (channel) to change.
5. Do one of the following:  
 Edit channels: Press the **Backspace** key to delete the channel number then enter a new channel number.  
 Add channels: Enter a channel number on a blank line.  
 Delete scan group: Delete the scan group name with the **Backspace** key.  
 Disable channels temporarily: Press the ← key to underline [Pass].
6. Press the **Enter** key twice.
7. Press the **Esc** key to close the menu.

## 8.5 How to Change the Window Color

You can select and change the window color.

1. Press the function key **F6** to open the [System] menu.
2. Press the → key to select [Change].
3. Press the ↓ key to select [Window Color] then press the **Enter** key to open the [Window Color Change] window.
4. Press the ← or → key to select [1], [2] or [3]. The selected preset color is reflected on the [Window Color Change] window.
5. Press the **Enter** key to reflect the selected preset color on the screen.

Window Color Change	
Select Preset	<b>1</b> 2 3
Load Default	
-----	
Edit Color	
Window	[ BASE WINDOW ]
Fore Color	[ BLACK ]
Back Color	[ WHITE ]
Brightness	0 1 2 3 4 5 6 7 8 9 <u>10</u>
-----	
To Change: ENTER To Change Value: L<=>R	

If you want to reset or change the preset settings, do the following:

1. Select [1], [2] or [3] then press the ↓ key.
2. To reset the settings, press the **Enter** key with [Load Default] selected. To change the settings, press the ↓ key. Go to step 3.
3. Press the ← or → key to select an option in [Window] and press the ↓ key.
4. Press the ← or → key to select a color in [Fore Color] and press the ↓ key.
5. Press the ← or → key to select a color in [Back Color] and press the ↓ key. **Note:** You cannot select the same color between [Fore Color] and [Back Color].
6. [Brightness] shows the current brightness setting for the LCD. To increase the brightness, press the **F7** key while pressing and holding the **Alt** key. To decrease the brightness, press the **F6** key while pressing and holding the **Alt** key. The changed brightness setting is underlined.
7. To confirm the selections, press the **Enter** key. To cancel the selections, press the **Esc** key. The window closes.

### Default for each preset

		Preset1 (original)	Preset2 (day)	Preset3 (night)
Brightness		10	10	5
Base window	Fore color	L-White	Black	L-White
	Back color	Blue	L-White	Black
Back scroll	Fore color	L-White	Black	Black
	Back color	Blue	White	Gray
Edit1	Fore color	Black	Black	Black
	Back color	Green	White	Gray
Edit2	Fore color	Magenta	Black	White
	Back color	White	L-Cyan	Blue
Function	Fore color	Black	Black	L-White
	Back color	Cyan	L-White	Black
Sub menu1	Fore color	Black	Blue	L-Cyan
	Back color	White	L-White	Black
Sub menu2	Fore color	Blue	Blue	L-Green
	Back color	White	White	Black

		Preset1 (original)	Preset2 (day)	Preset3 (night)
Sub menu3	Fore color	White	L-White	L-Magenta
	Back color	Black	Blue	Black
Message	Fore color	White	L-White	White
	Back color	Magenta	Blue	Blue

## 8.6 Screen Saver Function

Turn on or off the screen saver function. When there are no operation for 10 minutes, the screen is black and "IB-585" appears at random.

**Note:** This function is inoperative during standby and communication modes.

1. Press the function key **F4** then the ↓ key to select [Screen Saver].

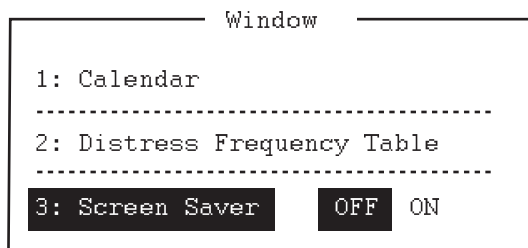

2. Press the → key to select [ON].
3. Press the **Enter** key to close the menu.

## 8. NBDP PREPARATIONS

This page is intentionally left blank.



# 9. NBDP FILE OPERATIONS

This chapter mainly describes how to create, save, open, edit and print files. The [Edit] menu provides a full lineup of editing facilities, including search and replace.

## 9.1 How to Open and Close Files

To create a telex message, you need to open a new file with the File Open command. When you open a new file, it is placed (opened) in one of two working areas. When both working areas are occupied, you must close a file to open a new file. This is done with the File Close command.

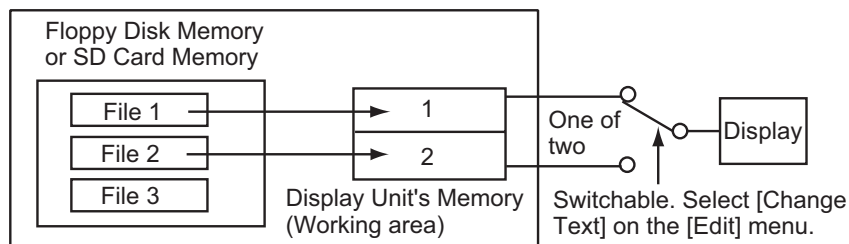

*How to open a file*

## 9.2 How to Create Files

There are two modes for creating the files; for messages and for macros.

- For messages: You can enter only the characters which are sendable in NBDP communication. Press the function key **F1** then the **1** key to create a message file.
- For macros: You can enter only the characters ( \$ @ \_ | ) which are used in a macro command. Press the function key **F1** then the **B** key to create a macro file.

1. Press the function key **F1** to open the [File] menu.

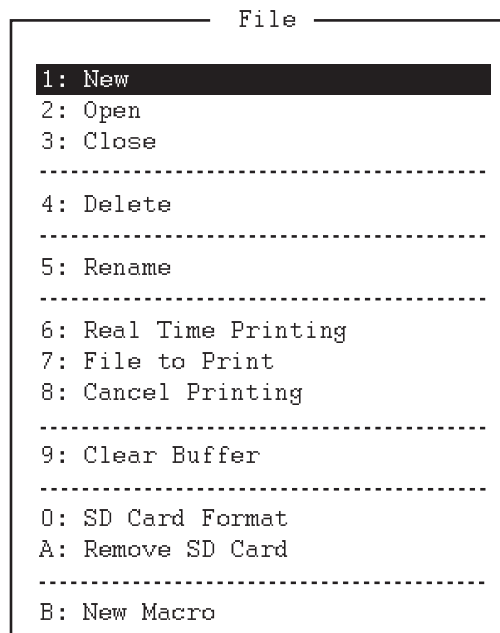

## 9. NBDP FILE OPERATIONS

2. Press the **1** key to select [New]. The title bar shows [UNTITLED 1] or [UNTITLED 2]. The cursor marks the location where you can type text.
3. Type your message.

**Note:** Lower case letters are sent as upper case letters. Also, do not use the symbols #, &, \*, \$ and % in telex messages. Do not put "\$\$\$" in the middle of a TX message, but at the end. The communication line is automatically disconnected when this string is detected. To enter "\$\$\$" when editing a message, press the **Ctrl + Q** keys.

### 9.3 How to Save a File

Use SD cards 2GB or less, or SDHC cards 32GB or less. Insert or eject the SD card with care when the power is off. Rough handling can destroy the information stored inside. To eject the SD card with power-on, execute [Remove SD Card] in the [File] menu (see "Function key F1: [File] menu" on page 7-6) then remove the SD card.

#### About the SD card (including SDHC)

SD cards of 2GB or less do not require formatting. Format cards of higher capacity (see paragraph 9.3.1).



**Note 1:** The message "Device Access Error" appears if an unformatted SDHC card is inserted in the drive when the power is turned on.

**Note 2:** If an SDHC card is formatted, its contents are deleted. The capacity of an SDHC card is reduced to 2GB after it is formatted.

**Note 3:** The formatted SDHC card is treated as 2GB SD card on external devices (PC, etc.).

The SD cards in the table below have been tested:

Type	Capacity	Maker
RP-SDP	4, 8, 16, or 32 GB	Panasonic
SD-E	4, 8, 16, or 32 GB	TOSHIBA
HPC-SD/SDH	2 or 4 GB	HAGIWARA SYS-COM
RSDC-S	2 or 8 GB	BUFFALO
SD/SDH-V	2 or 16 GB	I-O DATA
SDSDB	4, 8, 16, or 32 GB	SanDisk

### 9.3.1 How to format floppy disks or SD cards

Before you save a file to a floppy disk or an SD card, the disk or the card must be formatted. Format the disk or the card as below.

1. Press the function key **F1** to open the [File] menu.
2. Insert a new floppy disk or SD card in the drive.
3. Press the **0** key to select [SD Card Format].
4. Press the **↑** key to select [Yes] then press the **Enter** key. The screen shows formatting progress as below. After formatting has been completed, control is returned to the standby screen.

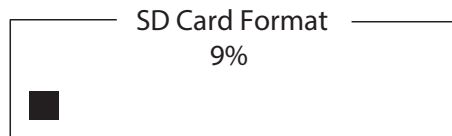

### 9.3.2 How to save a file

1. Press the function key **F1** to open the [File] menu.
2. Press the **3** key to select [Close]. The [Close Text] window appears.
3. With [Yes] selected, press the **Enter** key.
4. Enter the file name, using up to eight characters. You can use any alphabet or numeric on the keyboard. You can not use the symbols shown below. You can add an extension at the end of the file name, for example, .TXT, to distinguish text files from macro files. For macro files, add the extension ".MCR".

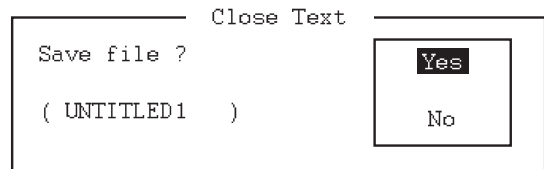

Unusable symbols | : " > < ;

5. Press the **Enter** key.

## 9.4 How to Edit Files

### 9.4.1 How to cut and paste text

You can delete, move and copy text by using the [Cut], [Copy] and [Paste] functions in the [Edit] menu.

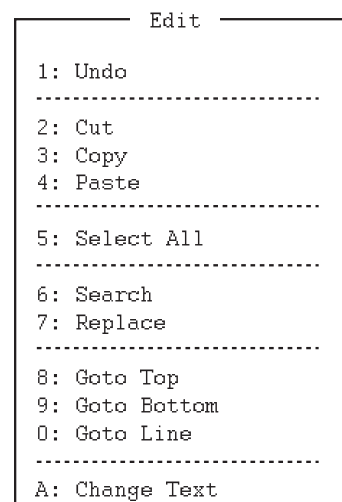

### How to cut text

1. Place the cursor on the first character of the text to cut.
2. Highlight the text to cut by pressing and holding the **Shift** key while pressing the **→** key. If you highlighted the text which you do not want to cut by mistake, press the **←** key to adjust the highlight.

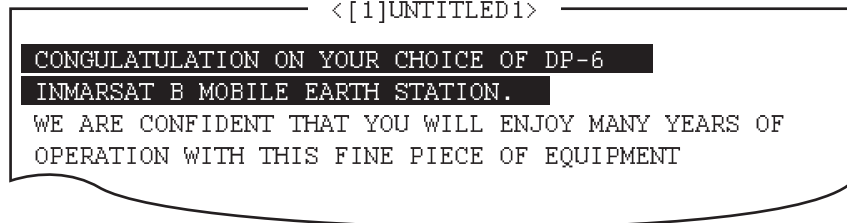

#### *The highlight*

3. Press the function key **F2** then the **2** key. Or press the **Del** key. The highlighted text is cut and the remaining text is reformatted.

If you made a mistake, you can restore the text. Select [Undo] in the [Edit] menu.

### How to paste text

To paste the cut text to a new location, do the following:

1. Place the cursor at the exact spot in the message where the cut text is to start.
2. Press the function key **F2** then the **4** key. Or press the **Ins** or **Insert** key.

## **9.4.2 How to copy and paste text**

You can copy a portion of text and paste it elsewhere.

1. Select the text to copy (see "How to cut text" on page 9-4).
2. Press the function key **F2** then the **3** key. The text selected is copied to the paste buffer memory where the cut or copied text is stored. The screen returns to the normal screen.
3. Place the cursor at the exact spot in the message where the copied text is to start.
4. Press the function key **F2** then the **4** key.

## **9.4.3 Select all**

The [Select All] feature lets you select all of the file currently displayed. This feature is useful when you want to combine the files. The procedure below explains how to place the file loaded in working area 1 onto the end of the file loaded in working area 2.

1. Load the file to copy from a floppy disk or an SD card in working area 1.
2. Press the function key **F2** then the **5** key. The entire file appears in reverse video.
3. Press the function key **F2** then the **3** key. The file is placed in the paste buffer memory.
4. Load the file to combine in working area 2.

- Place the cursor at the exact spot in the message where the text now in the paste buffer memory is to start then press the **Ins** or **Insert** key.

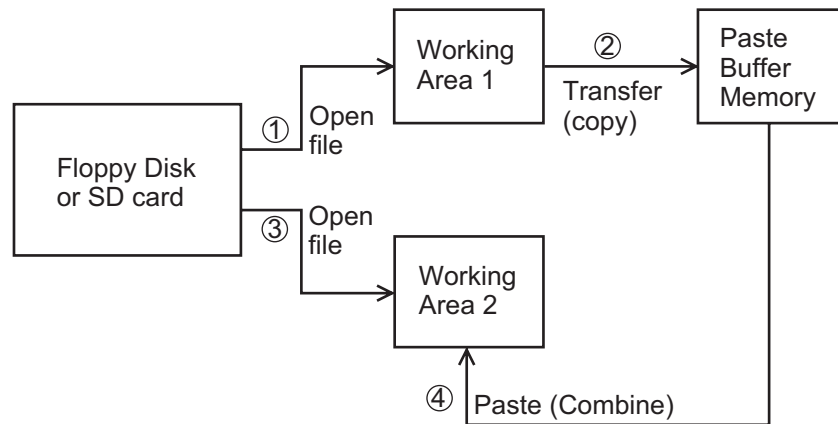

*Copy and paste flow diagram*

#### 9.4.4 How to search text

The [Search] feature lets you search for text in a forward or backward direction.

- Display a text and press the function key **F2** then the **6** key. The [Search] window appears.

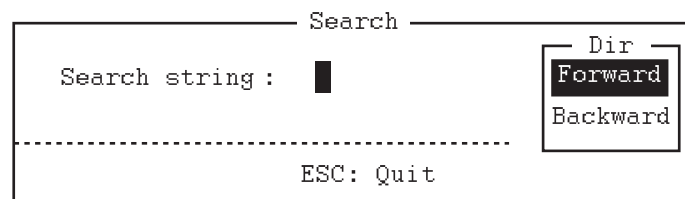

- Type the word to find.
- Press the → key.
- Press the ↑ or ↓ key to select [Forward] or [Backward] to search the file in a forward or backward direction respectively from the cursor position.
- Press the **Enter** key to begin the search.

When the unit finds the word, the cursor stops at the first character of the word. Press the **Enter** key to continue the search. If the string could not be found, the message "Not Found (To quit: ESC)" appears. Press the **Esc** key to quit.

#### 9.4.5 How to replace text

The [Replace] feature helps you to replace a word or phrase with another word or phrase in a file.

- Press the function key **F2** then the **7** key. The [Replace] window appears.

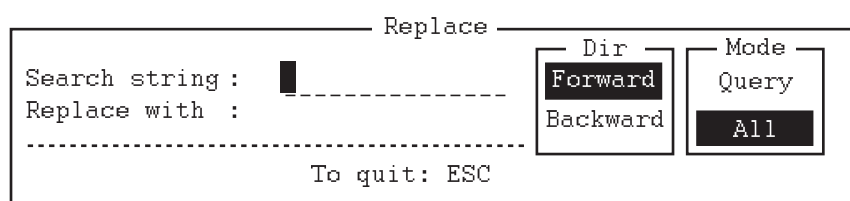

- Type a word to replace on the [Search string] line.

## 9. NBDP FILE OPERATIONS

3. Press the ↓ key to select [Replace with] then type a new word.
4. Press the ↓ key.
5. Press the ↑ or ↓ key to select [Forward] or [Backward] to search the file in a forward or backward direction respectively from the cursor position.
6. Press the → key.
7. Press the ↑ or ↓ key to select whether you want to be queried or not each time the word is found.  
[Query]: Stop at each occurrence of the word to answer yes or no for replacement.  
[All]: Replace every occurrence of the word without confirmation.
8. Press the **Enter** key to start the replacement.

### 9.4.6 Goto line

The [Goto Line] feature places the cursor at the head of a line desired.

1. Press the function key **F2** then the **0** key. The [Goto Line] window appears.

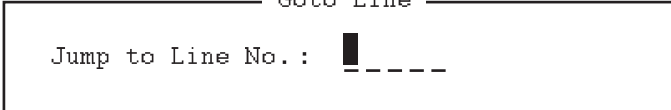

Goto Line

Jump to Line No. : █-----

2. Key in a line number then press the **Enter** key. The cursor shifts to the head of the line selected.

### 9.4.7 Goto top, Goto bottom

You can easily go to the top or bottom line of a file. Press the function key **F2** then the **8** key to go to the top line; press the function key **F2** then the **9** key to go to the bottom line. Note that this feature can also be executed on the editor screen by pressing the **Home** or **End** key.

## 9.5 How to Open Files

Two working areas (called working area 1 and working area 2) are provided to which you can load a file, and one file can be displayed on the LCD.

### 9.5.1 Open a file

1. Insert the floppy disk or the SD card which contains the file to open.
2. Press the function key **F1** to open the [File] menu.
3. Press the **2** key. A list of files on the floppy disk or the SD card appears.

```

----- Open Text -----
Load/Merge (TAB:Change)
[C:\TEST1. ]
-----File name-----Size---- Date & Time -----
LOG File           52    12-04-10 17:25
TEST1.             120    12-04-10 16:30
TEST2.             151    12-04-10  9:25
TEST3.             180    12-04-10 20:16
NBDP                169    12-04-10  6:23
[----- End of Directory -----]

4 Files exist                1454000 bytes free
-----
To select : ENTER  To view : SPACE  To quit : ESC

```

4. Press the  $\uparrow$  or  $\downarrow$  key to select a file.
5. Press the **Enter** key. The file appears and the title bar shows the file name. You can repeat this procedure to load another file into a working area.

**Note:** When two working areas have been opened, the close confirmation window appears. In this case, select [Yes] or [No] then press the **Enter** key to close an open file in order to open another file.

### 9.5.2 Switch between files

Two files can be opened and one file is displayed on the LCD. To switch between files, do the following:

1. Press the function key **F2**.
2. Press the **A** key to switch between the files.

## 9.6 How to Rename Files

To rename a file, do the following:

1. Press the function key **F1**.
2. Press the **5** key.
3. Press the  $\uparrow$  or  $\downarrow$  key to select a file to rename then press the **Enter** key.
4. Enter a new name.
5. Press the **Enter** key.

## 9.7 How to Save a File Under a New Name

You can save a file under a new name as follows:

1. Open a file.
2. Edit the file as necessary.
3. Press the function key **F1**.
4. Press the **3** key to save the file.
5. Press the **Y** key.
6. Press the **Backspace** key to erase the original name then enter a new name.
7. Press the **Enter** key.

## 9.8 How to Delete Files

Insert the floppy disk or the SD card in the drive and do the following to delete unnecessary files.

1. Press the function key **F1**.
2. Press the **4** key.
3. Press the  $\uparrow$  or  $\downarrow$  key to select the file to delete then press the **Enter** key.
4. Press the **Enter** key again. (To cancel, press the  $\downarrow$  key to select [NO] then the **Enter** key.)

## 9.9 Real Time Printing

An incoming or outgoing message can be printed out while it is being received or transmitted.

1. Press the function key **F1** to open the [File] menu.
2. Press the **6** key to turn real time printing on or off.

When the real time printing is on, "Print" appears in reverse video at the top of the screen. The sent messages are printed in bold face and the received messages are printed in normal type face.

## 9.10 How to Print Files

You can print files stored on the floppy disks or the SD cards as follows:

1. Press the function key **F1**.
2. Press the **7** key.
3. Press the  $\uparrow$  or  $\downarrow$  key to select a file then press the **Enter** key.
4. Press the **Y** key.

To stop printing at any time, press the function key **F1** then the **8** key. If the file could not be printed, the message "Cannot print. Check connection between printer and terminal. Press any key to escape." is displayed.



# 10. NBDP TRANSMISSION, RECEPTION

---

This chapter mainly shows you how to transmit and receive telex messages.

## 10.1 Manual Calling

### NOTICE

Before calling, watch the intended TX frequency carefully to confirm that is unoccupied.

The simplest way to communicate with a telex subscriber is manual calling. For the ARQ mode, you can display beforehand the message to send, or type your message manually.

1. Press the function key **F3** to open the [Operate] menu.

```
Operate
-----
1: Call Station
2: Macro Operation
-----
3: File to Send
4: Cancel Sending
-----
5: Scan (Start/Stop)
-----
6: Manual Reception
-----
7: Timer Operation
-----
8: Manual Calling
9: Set Frequency
0: Set Channel
```

2. To enter the frequency, press the **9** key to select [Set Frequency]. Go to step 3.

```
Set Frequency
-----
Tx Freq : .00
RX Freq : █.00
```

To enter the ITU or user channel, press the **0** key to select [Set Channel]. Go to step 4.

```
Set Channel
-----
Channel → : █
```

3. Input a pair of TX and RX frequencies. Go to step 5.

## 10. NBDP TRANSMISSION, RECEPTION

- Input the user channel. To select the user channel from the list, press the → key to display [User Channel List]. Press the ↑ or ↓ key to select the desired user channel.

User Channel List			
No.	Channel	TX Freq	RX Freq
1	0201	2174.5	2174.5
2	0401	4177.5	4177.5
3	0601	6268.0	6268.0
4	0801	8376.5	8376.5
5	01201	12520.0	12520.0
6	01601	16695.0	16695.0

- Press the **Enter** key.

**Note:** You can not set frequency or user channel in the following cases;

- When opening the menu from the control panel (FS-2575C).
- When communicating by radiotelephone.
- When the DSC scan screen is displayed.
- When sending DSC calls.

- Press the function key **F3** then the **8** key to select [Manual Calling].

```

Manual Calling
Mode : ARQ FEC
ID   :
    
```

- Press the ← or → key to select a communication mode.
- Press the ↓ key then input party's ID number.
- Press the **Enter** key to connect the communication line. "Channel Busy Check" appears. If the line is free, "Connect", "Send" and "Lock" appear in highlight as below.

```

1:File 2:Edit 3:Operate 4:Window 5:Station 6:System 7:WRU 8:HR 9:Over 10:Break
                                     10-Apr-2012 15:10:30 UTC —Caps-Eng
Station Name      :
Frequency (T/R)  : 8765.00 / 8965.00(kHz)  Comm Mode :ARQ
Comm Status      : Connect Send Lock Error
Sending Volume   : 100(%)      Error : 0      ARQ Time : 0(sec)
    
```

For the ARQ mode, go to step 10. For the FEC mode, type your message then go to step 14.

- Press the function key **F7**. The party's answerback code appears on the screen.  
**Note:** Step 10 and 11 are needed for ship-to-ship calling only.
- Press the function key **F8**. Your ship's answerback code is sent to the party.
- Press the **Enter** key and type your message.
- If you want to receive other party's response, press the function key **F9**.
- Press the function key **F10** to disconnect the line.

## 10.2 ARQ Mode Operation

In ARQ mode, one station (information sending station) sends data to another block by block, then listens for the acknowledge signal between blocks from the information receiving station which requests either the next block or retransmission of the last block if there is an error. The request can be repeated up to 32 times until the complete block is received free of error.

### How to establish connection

1. Press the function key **F3** to open the [Operate] menu.
2. Press the **1** key to select [Call Station].

```

1:File 2:Edit 3:Operate 4:Window 5:Station 6:System 7:WRU 8:HR 9:Over 10:Break
----- 10-Apr-2012 15:10:30 UTC -----Caps-Eng
Station Name      :  CHOUSHI-8M
Frequenc          :  Call Station
Comm Sta         :  Station List
Sending          :  Station Setup
-----
ABC-4M
ABC-6M
ABC-12M
ABC-8M
FURUNO
Station : ABC-4M
ID Code : 45678
Mode    : ARQ FEC
CH/Table : Channel Scantable
Num/Table:

```

3. Select a station. (Station must be registered for use in the ARQ mode).
4. Press the **Enter** key. The message "Calling Station" appears. If the message shown below appears, check both the power of the radiotelephone and the connections between the radiotelephone and the NBDP terminal unit.  
 Message: "Station calling suspended. Check interconnections between the terminal and main units. Press any key to escape."  
 When an acknowledge signal is detected, "Connect" appears in reverse video on the [Comm Status] line.  
**Note:** If the signal conditions are poor, connection can take a while. If the line could not be connected in one minute, the calling stops. The message "Station calling suspended" appears. Try step 3 again, one minute later. Should the signal conditions worsen during message transmission, "Error" appears in reverse video on the [Comm Status] line and the line is disconnected.
5. Transmit message by one of the following methods:  
How to send a file stored on a floppy disk or an SD card
  - 1) Press the function key **F7** to request the answerback code of the other station. Verify that the code from the station called is correct.
  - 2) Press the function key **F8** to transmit your own identity (answerback code).
  - 3) Press the function key **F3** then the **3** key to open the [Send File] window.
  - 4) Press the **↑** or **↓** key to select the file to send and press the **Enter** key.

5) Press the **Enter** key again.

```

----- Send File -----
[A:\TEST1. ]
-----File name-----Size---- Date & Time -----
LOG File           52   12-04-15 17:25
TEST1.             120   12-04-10 16:30
TEST2.             151   12-04-11 09:25
TEST3.             180   12-04-11 20:16
NBDP               169   12-04-12 06:23
[-----End of Directory -----]

4 Files exist           1454000 bytes free

-----
To select : ENTER To view : SPACE To quit : ESC
    
```

Sending volume (percentage of message transmitted, counts upward as the message is being transmitted), ARQ error count and ARQ transmission time appear on the screen. "Lock" appears in reverse video when the mark and space signals in the received signal are normal. [Error] shows the number of errors found during transmission. [ARQ Time] is the time in seconds the communication connected.

```

1:File 2:Edit 3:Operate 4:Window 5:Station 6:System 7:WRU 8:HR 9:Over 10:Break
----- 10-Apr-2012 15:10:30 UTC -----Caps-Eng
Station Name      :
Frequency (T/R)  : 8765.00 / 8965.00(kHz)  Comm Mode :ARQ
Comm Status      : Connect Send Lock Error
Sending Volume   : 100(%)   Error : 0   ARQ Time : 0(sec)
    
```

6) After the message is transmitted, press the function key **F10** to disconnect the line.

How to type a message from the keyboard

- 1) After exchanging answerback code by the function keys **F7** and **F8**, type your message directly from the keyboard.
- 2) To change the direction of traffic, press the function key **F9**, or **+** and **?** in order. The other station becomes the information sending station, your station becomes the information receiving station. Receive a message from the sending station.
- 3) After you have completed communications, press the function key **F7** to request the answerback code of the other station.
- 4) Press the function key **F8** to transmit your own answerback code.
- 5) Press the function key **F10** to disconnect the line.

**Note:** When you are requested to change the direction of traffic while transmitting a message, or communication is interrupted because of an error, some of the final characters on the screen may not be sent to the receiving station.

How to stop transmission

1. Press the function key **F3** then the **4** key. The message "Canceled Sending" appears on the screen. Transmission is stopped but the line is still connected.
2. Press the function key **F10** to disconnect the line.

## 10.3 FEC Mode Operation

The FEC mode transmits the same data twice for less errors using a time diversity technique.

1. Press the function key **F3**.
2. Press the **1** key to open the [Call Station] menu.
3. Press the  $\uparrow$  or  $\downarrow$  key to select a station which is registered for the FEC mode.
4. Press the **Enter** key. "Connect" appears in reverse video.
5. Transmit a message directly input from the keyboard, or do the following to transmit a message stored on a floppy disk or an SD card:
  - 1) Press the function key **F3** then the **3** key to select [File to Send].
  - 2) Press the  $\uparrow$  or  $\downarrow$  key to select the file to send then press the **Enter** key twice.
6. After the message is transmitted, press the function key **F10** to disconnect the line.

**Note 1:** When communication is force-quit by control display, some of the final characters may not be sent to the receiving station.

**Note 2:** When continuous transmission on the FEC mode exceeds one minute, the output power is automatically reduced to low to prevent overheating.

## 10.4 How to Select Reception Mode

1. Press the function key **F3** then the **6** key to open the [Manual Reception] menu.
2. Press the  $\leftarrow$  or  $\rightarrow$  key to select the reception mode:
  - [AUTO]: Automatic reception in ARQ or FEC mode
  - [ARQ]: International radiotelex ARQ mode
  - [FEC]: International radiotelex FEC mode
3. Press the **Enter** key. The reception mode appears on the screen.
4. Press the **F3**, and **9** or **0** key then wait for connection.
 

When a call to your ship is detected, [Lock] is highlighted. After the synchronization is completed, the line is connected. [Connect] is highlighted.

All received (and transmitted) messages are saved to a floppy disk or an SD card when [TX/RX MSG Save] is [ON] in the [System] menu. The file is automatically named (see the figure).

<u>12</u>	<u>04</u>	<u>10</u>	0	0.	<u>X</u>	<u>X</u>	<u>X</u>
$\uparrow$	$\uparrow$	$\uparrow$			$\uparrow$		
Year	month	date			Serial number	from 000	
5. After receiving the EOC, NBDP reception is automatically canceled. NBDP reception can also be canceled manually with the **F10** key. The equipment goes into standby mode.

**Note 1:** For NBDP activated by the DSC function, select [QUIT] option on the control panel to cancel reception mode and go to the standby mode.

**Note 2:** During reception in FEC mode, the characters which are not detected because of reception error are displayed as "\*\*\*".

## 10.5 Communication Example

Call the coast station following the procedure in section 10.2. Then, communicate with the coast station. Below is a communication example.

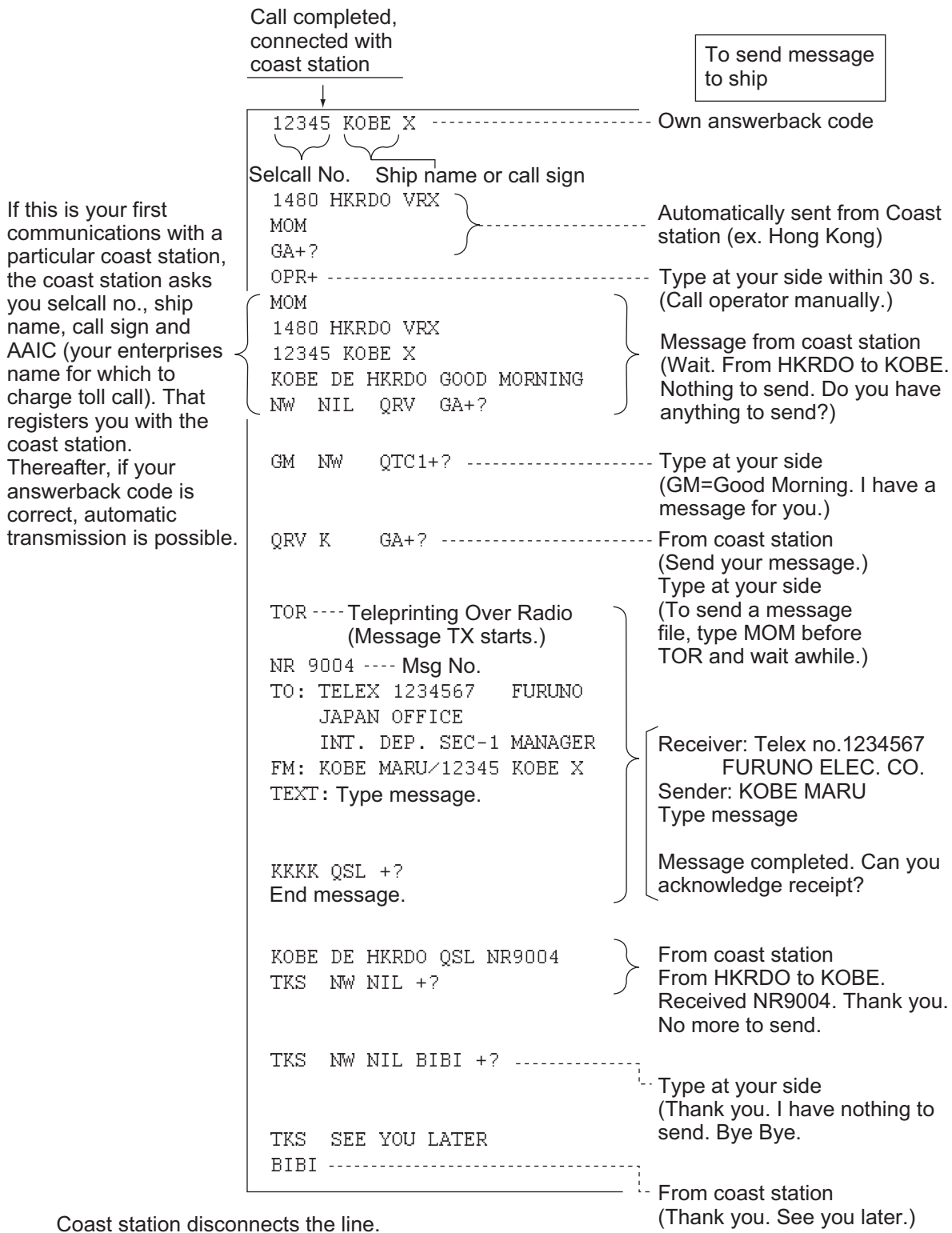

Communications example

Table of abbreviations

Abbreviation	Question	Answer or Advice
QRA	What is the name of your station?	My station name is...
QRC	By what private enterprise are the accounts for charges for your station settled?	The accounts for my station are settled by the private enterprise...
QRU	Have you any thing for me?	I have nothing for you.
QRV	Are you ready?	I am ready.
QRX	When will you call me again?	I will call you again at... hours [on... kHz].
QSJ	What is the charge to be collected to... including your internal charge?	The charge to be collected to... including my internal charge is...
QSL	Can you acknowledge receipt?	I can acknowledge receipt.
QSX	Will you listen to... [call sign] on... kHz?	I am listening to... [call sign] on... kHz.
QTA	Shall I cancel message number...?	Cancel message number...
QTC	How many messages have you to send?	I have... message for you.
QTU	What are the hours your station is open?	My station is open from... to... hours.
Abbreviation	Definition	
BK	Signal used to interrupt a transmission progress.	
CFM	Confirm	
DE	From...	
K	Invitation to transmit.	
NIL	I have noting to send to you.	
NW	Now	
PSE	Please	
R	Received	
REF	Reference to...	
SVC	Prefix indicating a service telegram.	

Command and abbreviation

Command	Function
TGM+	To indicate that the following message is a radiotelegram.
MSG+	To indicate that the ship station needs to be connected immediately any message held.
OPR+	Call operator.
URG+	Safety, urgency and distress message.
MED+	Request medical advice.
TEST+	Request coast station to send a test message for checking the ship station.
BRK+	To clear the connection with the coast station.
Abbreviation	Function
GA+	I am ready. Transmit your command.
MOM	Wait a moment.
MSG+	Request pending messages from the shore.
KKKK or NNNN	Terminate a message.
XXXXX	Typo

## 10.6 Timer Operation

A built-in timer permits automatic transmission and reception of telex messages.

### 10.6.1 How to enable timer operation

1. Press the function key **F3** to open the [Operate] menu.
2. Press the **7** key to open the [Timer Operation List].
3. Press the  $\uparrow$  or  $\downarrow$  key to select the operation (name) to execute.
4. Press the **Enter** key. An asterisk appears beside the operation selected and "T. Op" appears in reverse video on the communication status screen. If a file stored on a floppy disk or an SD card is to be sent, be sure the floppy disk or the SD card containing the file is inserted in the drive.

```

Timer Operation List
* 1
  2
  3
  OP4
  OP5

```

5. If desired, select another operation (name) then press the **Enter** key.
6. Press the **Esc** key.

When the predetermined time has passed, the NBDP terminal unit automatically sends or receives the message. The results of timer operation are displayed as either [OK] or [NG] (No Good) on the [Timer Operation List] window. For transmission, [OK] is displayed when the message is perfectly (100 percent) sent. For receiving, [OK] is displayed when connecting the timer operation then disconnecting.

```

Timer Operation List
* 1                OK
  2
* 3                OK
*OP4              OK
*OP5              NG

```

### 10.6.2 How to stop timer operation

1. Press the function key **F3**.
2. Press the **7** key.
3. Press the  $\uparrow$  or  $\downarrow$  key to select the operation (name) which has an asterisk attached to it then press the **Enter** key. Remove all asterisks to cancel all timer programs. "T. Op" disappears from the communication status screen.



## 10.7 Scanning

The radio equipment scans a group of operator-selected frequencies (channels), and stops scanning when a signal is received. See section 8.4 for registration of scan group.

1. Press the function key **F3** then the **5** key to open [Scanning Group List]. You can confirm the scan channel by pressing the  $\uparrow$  or  $\downarrow$  key while pressing the **Shift** key.

```

Scanning Group List
1 Coast Station A
2 Coast Station B
3 Coast Station C

```

2. Press the  $\uparrow$  or  $\downarrow$  key to select a scan group then press the **Enter** key. The scanning starts and the indication "Scan" appears in reverse video. Further, the name of the scan group appears in the [Station Name] field.

```

1:File 2:Edit 3:Operate 4:Window 5:Station 6:System 7:WRU 8:HR 9:Over 10:Break
10-Apr-2012 15:10:30 UTC Caps-Eng
Station Name      : SAITO-1          Scan
Frequency (T/R)  : 8344.00 / 8705.00(kHz)  Comm Mode : Auto
Comm Status      : Connect Send Lock Error
Sending Volume   : 100(%)  ARQ Error : 0  ARQ Time : 0(sec)

```

### *Communication status screen*

3. Press the function key **F3** then the **5** key to stop scanning. "Scan" disappears from the communication status screen.

## 10.8 Communication Buffer

The communication buffer is a temporary memory which stores the transmitted and received messages. To display the contents of the communication buffer, do the following:

1. If open, close the [Edit] window 1 or 2, pop-up, or menu.
2. Press the **Pg Up** or **Page Up**, or **Pg Dn** or **Page Down** key. The contents of the communication buffer are displayed.

Press the **P** key while pressing the **Ctrl** key to print them. Press the function key **F1** then the **9** key to erase the contents of the buffer. To erase the contents from the screen, do one of the following:

- Press the **Pg Dn** or **Page Down** key on the last page.
- Press the  $\downarrow$  key at the bottom line.
- Press the **Esc** key.

## 10.9 Preparation of Macrofiles for Automatic Telex

### 10.9.1 Automatic telex overview

This section shows you how to communicate with a coast station which handles automatic telex transmission, using macrofiles. You need to register communication channels and stations, and prepare macrofiles.

The coast stations using automatic telex are MCI Marine Services (North America), Sydney Radio (Australia), Lyngby Radio (Denmark), and others. The procedure is mostly common to all coast stations, however refer to the coast station's traffic manual for details.

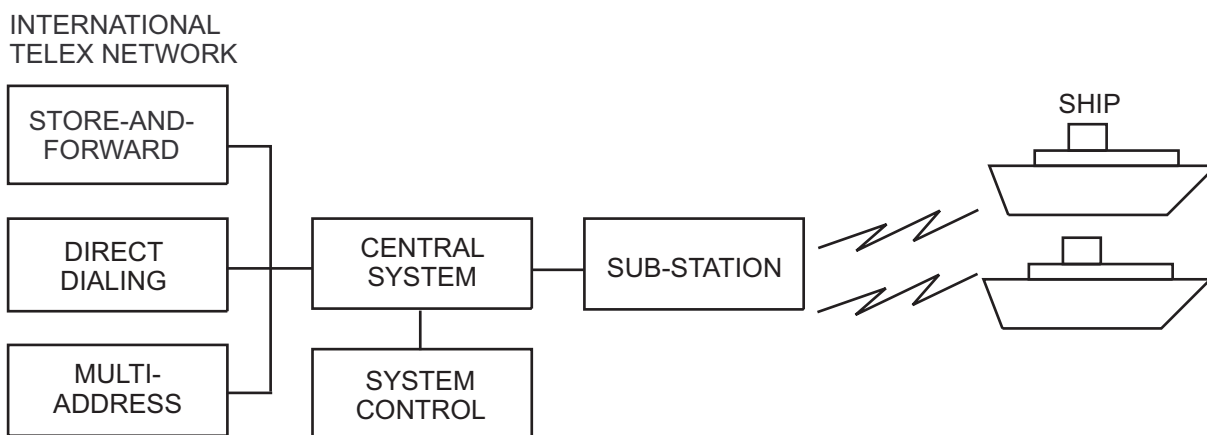

*Sample of automatic telex network*

The services available in automatic telex are

- Message transfer between ship and coast station (store-and-forward)
- Connection with landline telex (direct dialing)
- Multi address

### 10.9.2 Preparations

You need to register the following three items to use automatic telex.

- Answerback code
- Scan groups
- Station names

#### How to register answerback code

The coast station assigns a telex number. This number functions as an answerback code. An answerback code contains the following:

```
OOOOO SHIP X
```

OOOOO: Coast station-assigned five-digit telex code  
 SHIP: Ship name  
 X: For shipboard station, normally X is entered

The procedure to register the answerback code is the same as which appears in paragraph 8.1.1. If an answerback code was registered before the commissioning of

the coast station, a new answerback code must be entered. Contact FURUNO or an authorized FURUNO agent or dealer to enter a new answerback code.

### **How to register scan groups**

The central system emits a free-signal to indicate a coast station radio channel is in idle condition and available for ship-to-shore calls. The free-signal is detected and recognized by the shipboard equipment as a permission to start the transmission. Then, the shipboard operator initiates a call.

You can automatically scan search for the free-signal by registering coast station radio channels in scan group(s). The procedure to register scan groups for coast station use is the same as that which appears in paragraph 8.4.1.

### **How to register stations**

The next step is to enter station name. The procedure is the same as that shown in paragraph 8.2.1.

## **10.9.3 Commands**

The following tables describe the commands for macro operation.

<b>Command (Prefixed with @)</b>	<b>Parameter</b>	<b>Content</b>
CALL	S: Station Name	Calling station name and ID on assigned parameter
FREE (support command for CALL)	Two digits, 0-99 min	Free-channel signal searching time according to assigned parameter (default setting: 10 min)
	\$R\$	Detect free-channel signal of 200 ms dot pattern
	\$RR\$	Detect free-channel signal of 300 ms dot pattern
	\$RRR\$ (default)	Detect free-channel signal of 400 ms dot pattern
	\$RRRR\$	Detect free-channel signal of 500 ms dot pattern
	\$RRRRR\$	Detect free-channel signal of 600 ms dot pattern
	\$RRRRRR\$	Detect free-channel signal of 700 ms dot pattern
	\$RRRRRRR\$	Detect free-channel signal of 800 ms dot pattern
	\$RRRRRRRR\$	Detect free-channel signal of 900 ms dot pattern
	The combination of two capital letters and "c". For example: \$EcR\$	Detect free-channel signal like ARQ call block E, RQ, R for repetition signal RQ.

10. NBDP TRANSMISSION, RECEPTION

<b>Command (Prefixed with @)</b>	<b>Parameter</b>	<b>Content</b>
RETRY (support command for CALL)	Two digits, 0-99 min	Calling according to assigned parameter (default setting: 10 min)
CASE	Text	For receiving a message (designated by parameter) transmitted by coast station
TIMEOUT (support command for CALL)	Two digits, 0-99 min	Time allotted for reception of message by CASE command
SEND	Text	Text transmitted according to assigned parameters
	A: file name	Send a file from floppy disk
WRU HR OVER BREAK	None	Function keys <b>F7 - F10</b>
DISPLAY	Text	Text of message appears
INPUT	None	Waiting for keyboard input. Transmit keyboard input message.

**Example: Commands**

<b>Command</b>	<b>Function</b>
BRK+	Disconnect communications line
DIRTLX..... +	Direct dialing telex (receive only)
KKKK	Terminate message
LTR+	For telex letters mailed from Operations Station to destinations worldwide
MED+	Request medical advice
OPR+	Request operating assistance
POS+	Send position data
STA+	Status requested on a store-and-forward message
TLX..... +	Store-and-forward method

For details, see the coast station's traffic manual.

### 10.9.4 Store-and-forward method

The following is the sequence of events for transmission of a file by the store-and-forward method.

1. Ship station sends message to coast station.
2. Coast station stores message in memory buffer.
3. Ship station and coast station clear the radio circuit.
4. Coast station sends message to subscriber designated.

#### *Actual procedure for store-and-forward telex*

No.	Procedure	Display	Remarks
1	Call a coast station.	"Connect" appears in reverse video and bell sounds.	Free-signal found; radio circuit ready.
2	Transmit WRU signal.	00190 TLG DK 26XXX SHIP X GA+?	Initial identity exchange between coast station and ship-board station.
3	Key in subscriber's telex number. Example: (Hong Kong) 12345  <div style="border: 1px solid black; padding: 2px; width: fit-content; margin: 5px auto;">TLX80212345+</div>	MSG+?	Request to start message transmission.
4	Transmit file.		Message transmission.
5	When transmission is completed, type KKKK.	26XXX SHIP X 00190 TLG DK GA+?	Transmit your answer-back code. Receive other party's answer-back code.
6	Transmit BREAK command to clear radio circuit.		

#### *Procedure to prepare a macrofile for store-and-forward method*

You need a macrofile to enable automatic message transmission by store-and-forward method. After preparing it, save it to a floppy disk for future use.

1. Press the function key **F1** to open the [File] menu.
2. Press the **B** key.

10. NBDP TRANSMISSION, RECEPTION

3. Prepare the macrofile. Below is a simple example.

```
< [1] UNTITLED1 >  
@FREE $RRR$ ..... ①  
@CALL S:LYNGBY RADIO ..... ②  
@WRU  
@CASE GA+?  
@SEND TLX80212345+ ..... ③  
@CASE MSG+?  
@SEND A: \ABC ..... ④  
@SEND KKKK ..... ⑤  
@CASE GA+?  
@SEND BRK+
```

- ① Search dot pattern free signal until it is found
- ② Station name (Example: LYNGBY RADIO)  
Who are you?  
Station identity exchange
- ③ Subscriber's telex number (in example, 802 is country code of Hong Kong) for store-and-forward method
- ④ Location and name of file message  
A: \ABC
- ⑤ Request for termination of message

*Sample macrofile for store-and-forward method*

- 4. Press the function key **F1** to open the [File] menu.
- 5. Press the **3** key. The [Close Text] appears.

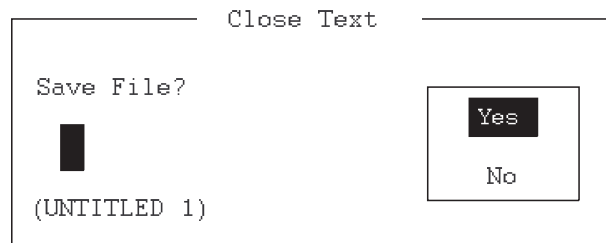

6. Press the **Enter** key then enter a file name as follows:

○○○○○○○○○.MCR  
↑                   ↑  
File name (max. 12 characters in conjunction with identifier)    Extension name

7. Press the **Enter** key.

**DIRTLX macrofile*****Sample DIRTLX macrofile***

```

< [1] UNTITLED1 >
@FREE $RRR$ ----- ①
@CALL S:LYNGBY RADIO ----- ②
@WRU
@CASE GA+?
@SEND DIRTLX725644325+ ----- ③
@CASE MSG+?
@SEND A: \ABC ----- ④
@SEND KKKK ----- ⑤
@CASE GA+?
@SEND BRK+

```

- ① Search dot pattern free signal until it is found
- ② Station name (Example: LYNGBY RADIO)  
Who are you?  
Station identity exchange
- ③ Subscriber's telex number (in example, 72 is country code of Japan) for direct dialing mode
- ④ Location and name of file message  
A: \ABC
- ⑤ Request for termination of message

***Sample DIRLTX macrofile***

## 10.10 Automatic Telex Using Macrofile

This section describes how to transmit a telex message using a macrofile.

**Basic procedure**

1. Register an answerback code (telex number assigned by the coast station).
2. Register the coast station frequency and channel to a scan group.
3. Register the station name including the scan group name.
4. Retrieve a macrofile. Include the station name and the message file name. Type the message and save the file.
5. Open the macro operation menu and select a macrofile. Your message will be transmitted automatically. Below is the sequence of automatic message transmission to a coast station.
  - 1) Search for free-signal
  - 2) Call coast station on one of its radio channels
  - 3) After connection is established, identity exchange
  - 4) Transmission of service category and subscriber's address
  - 5) Transmission of message

## 10. NBDP TRANSMISSION, RECEPTION

- 6) Transmission of termination of message signal
- 7) Identity exchange
- 8) Clearing of radio circuit

### **Actual procedure**

1. Press the function key **F3** to open the [Operate] menu.
2. Press the **2** key to open the [Call Macro] window.

```
Call Macro
[A:\TEST1. ]
-----File name ----- Size---- Date & Time -----
LYNGBY1.MCR          169    12-04-10 06:23
[----- End of Directory -----]

1 Files exist          1454000 bytes free
-----
To select : ENTER To view : SPACE To quit : ESC
```

3. Press the ↓ key to select a macrofile.
4. Press the **Enter** key.

```
Call Macro: Lyngby1.MCR
Call OK?
Yes
No
```

5. Press the **Enter** key to confirm the macrofile selected. The message "Wait for Free Signal" appears. Your message is transmitted automatically.



# 11. MAINTENANCE & TROUBLESHOOTING

**WARNING**

**ELECTRICAL SHOCK HAZARD**  
Do not open the equipment.

Only qualified personnel should work inside the equipment.

**NOTICE**

Do not apply paint, anti-corrosive sealant or contact spray to plastic parts or equipment coating.

Those items contain products that can damage plastic parts and equipment coating.

## 11.1 Test

Do the following tests to check the radiotelephone for proper operation.

### Daily test

1. Rotate the **ENTER** knob to select [TEST] on the [MENU] screen then push the knob.



2. With [DAILY TEST] selected, push the **ENTER** knob to start the test. After completing the test, the audio alarm sounds and the screen shown below appears. This screen shows:
  - Program version numbers.
  - Test results for RX, DSC, WR1 and WR2, shown as [OK] or [NG] (No Good). For NG, contact your dealer for advice. The DSC test checks, using a DSC signal, the encode and decode functions of the signal processor.

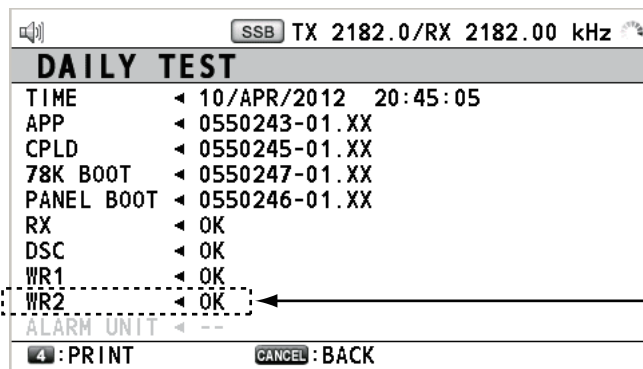

When not connecting WR2, this item is grayed out.

To print out the test result manually, press the 4 key. Automatic printing of the daily test is available. See section 6.6.

**TX self test**

1. Rotate the **ENTER** knob to select [TEST] on the [MENU] screen then push the knob.
2. Rotate the **ENTER** knob to select [TX SELF TEST] then push the knob. [OK] or [NG] (No Good) appears as the test result for each item. For [NG], contact your dealer for advice.

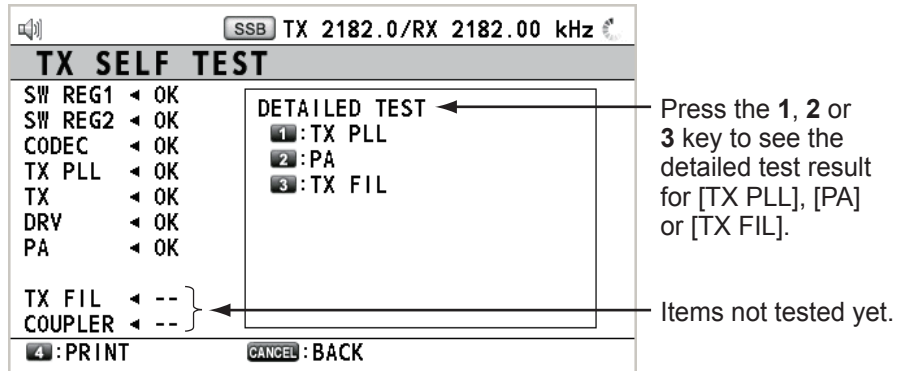

[SW REG1], [SW REG2]: For FS-2575/5075  
 [DRV]: For FS-2575/5075  
 [PA2], [COMB] ([DETAILED TEST] for [PA]): For FS-5075  
 Others: For FS-1575/2575/5075

**Tone test (SSB mode)**

You can execute tone test with lowering transmission power.

1. Rotate the **ENTER** knob to select [TEST] on the [MENU] screen then push the knob.
2. Rotate the **ENTER** knob to select [TONE TEST] then push the knob.

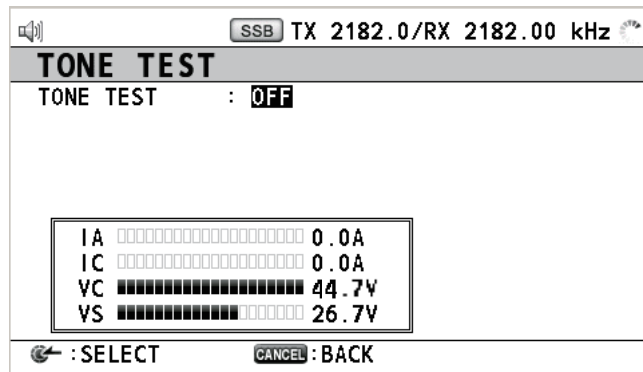

3. With [OFF] selected, push the **ENTER** knob.

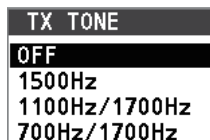

4. Rotate the **ENTER** knob to select the item desired then push the knob. When pressing the **PTT** switch of the handset, the sound from the speaker is lost then the selected tone signal is output. The output of the tone signal stops after one minute or when releasing the **PTT** switch.

## 11.2 Maintenance

Regular maintenance helps to keep your equipment in good condition and prevents future problems. Check the items shown in the table below.

Item	Check point	Remedy/Remarks
Antenna	Check for physical damage and corrosion.	Replace damaged parts.
Wire antenna	Check that the antenna is properly spanned and separated sufficiently from metallic structures.	If necessary, re-span antenna.
Insulators for antenna	Check for salt water deposits on insulators. Check that connection at the lead-in insulator is tight and rust-free.	Replace damaged insulator(s). Remove salt water deposits. Clean with fresh water, then dry. Remove rust, then tighten bolts and lock nuts. Cover metallic surface with sealing compound.
Antenna coupler	<ul style="list-style-type: none"> <li>• Check condition of antenna terminal, ground, coaxial cable and control cable.</li> <li>• Check that coupler lid and cable glands are firmly secured.</li> <li>• Check for physical damage, corrosion and salt water deposits.</li> </ul>	<ul style="list-style-type: none"> <li>• Tighten the loosened connections.</li> <li>• Fasten the lid firmly and evenly to prevent water leakage.</li> <li>• Replace if damaged.</li> </ul>
Control unit	<ul style="list-style-type: none"> <li>• Check ground connection, control cable, and external equipment.</li> <li>• Confirm that there are no objects on the top of the control unit.</li> <li>• Remove dust from control unit with soft cloth.</li> </ul> <p><b>Note:</b> Do not use chemical cleaners to clean the control unit; they can remove paint or markings and deform the equipment.</p>	<ul style="list-style-type: none"> <li>• Tighten the loosened connections; remove foreign materials from connectors.</li> <li>• Remove any objects.</li> <li>• Wipe the LCD carefully to prevent scratching, using tissue paper and an LCD cleaner. To remove dirt or salt deposits, use an LCD cleaner, wiping slowly with tissue paper so as to dissolve the dirt or salt. Change paper frequently so the salt or dirt does not scratch the LCD.</li> </ul>
Transceiver unit	<ul style="list-style-type: none"> <li>• Check connection at signal cable, coaxial cable, control cable, power cable, and navigator.</li> <li>• Confirm that there are no objects on the top of the cabinet.</li> </ul>	<ul style="list-style-type: none"> <li>• Tighten loosened connections; remove foreign materials from connectors.</li> <li>• Remove any objects.</li> </ul>
Power supply	Check that the supply voltage at transmission is within the rated range (21.6 to 31.2 VDC at the power connector).	If not within the range, check power source. Low voltage may cause erratic operation.

## 11.3 Simple Troubleshooting

The table below provides possible problems and the means with which to restore normal operation. If normal operation cannot be restored, do not attempt to check inside the equipment. Any servicing should be referred to a qualified technician.

Problem	Probable cause	Remedy
Power cannot be turned on.	<ul style="list-style-type: none"> <li>• Mains switchboard is off.</li> <li>• (DC) voltage is too high.</li> <li>• Battery has discharged, or poor contact at terminals.</li> </ul>	<ul style="list-style-type: none"> <li>• Turn on the mains switchboard.</li> <li>• Check supply voltage.</li> <li>• Recharge the battery and tighten the battery terminals.</li> </ul>
Display indications do not appear.	Display brilliance is too low.	Press the <b>BRILL</b> key to adjust the display brilliance.
Power is on but no sound from the main speaker.	Main speaker is off.	Press the  key to turn on the main speaker.
Poor articulation	Wrong class of emission.	Class of emission should match that of incoming signal.
Output power reduced to LOW	Power is automatically reduced to protect against overheating due to continuous transmission.	Wait until the unit cools.
Antenna coupler cannot tune antenna.	<ul style="list-style-type: none"> <li>• Antenna is disconnected or shorted to ground.</li> <li>• Antenna is out of tunable length.</li> <li>• Poor grounding of antenna coupler.</li> <li>• Breaker in coupler has tripped.</li> <li>• Connection cable loosened or disconnected.</li> </ul>	<ul style="list-style-type: none"> <li>• Check the antenna connection.</li> <li>• Recommended length is 10 to 18 meters.</li> <li>• Check coupler ground.</li> <li>• Check the power and polarity of the antenna coupler. If normal, reset the breaker.</li> <li>• Check the cable.</li> </ul>

## 11.4 Error Messages

The table below shows error messages, their meanings, and remedies. To delete the messages, press the **CANCEL** key. If other error occurs, contact your dealer.

Error message	Meaning	Remedy
System was rebooted.	Unusual event is detected.	System restarts automatically.
The unit will not transmit any DSC call until own ship's MMSI is entered. [CANCEL]: Stop alarm	You tried to send a DSC message but your MMSI has not been registered in the equipment.	Enter MMSI no. of your ship.

## 11.5 Breaker on PR-850A

The AC-DC power supply unit PR-850A has a circuit breaker. If the breaker has tripped, find the reason before resetting the breaker.

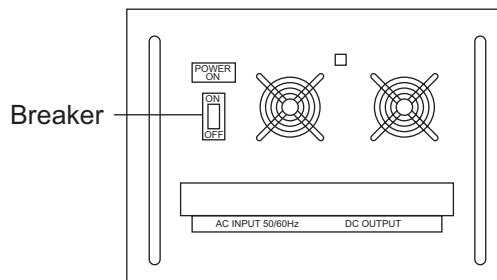

## 11.6 Test Call

This function sends a test signal to a coast or ship station, over one of six distress and safety frequencies. For that reason, it should not be executed unnecessarily. You can prepare a test call beforehand (see paragraph 6.16.5).

1. Press the **OTHER DSC MSG** key to open the [COMPOSE MESSAGE].
2. Rotate the **ENTER** knob to select [MSG TYPE] then push the knob.
3. Rotate the **ENTER** knob to select [TEST MSG] then push the knob. [PRIORITY] is automatically set to [SAFETY].
4. With [TO] selected, push the **ENTER** knob.
5. Rotate the **ENTER** knob to select [DIRECT INPUT] or [ADDRESS BOOK DATA] then push the knob.  
 [ADDRESS BOOK DATA]: Select an MMSI from the [ADDRESS BOOK] (see section 6.15) then push the **ENTER** knob.  
 [DIRECT INPUT]: Enter the MMSI of the station where to send the test message then push the **ENTER** knob.
6. With [DSC FREQ] selected, push the **ENTER** knob.
7. Rotate the **ENTER** knob to select DSC frequency then push the knob.
8. With [GO TO CALL] selected, push the **ENTER** knob to send the test message. The screen is changed to one for transmission. After the call is sent, the equipment waits for acknowledgment of the call. The timer starts counting up the time to wait for acknowledgment.
9. Do one of the following.

### Test acknowledge message received

The audio alarm sounds and the message "TEST ACK received! [CANCEL]: Stop alarm" appears. Press the **CANCEL** key to silence the alarm.

### No response

**Re-send call:** Rotate the **ENTER** knob to select [RESEND] in the user options area then push the knob.

**Cancel call:** Rotate the **ENTER** knob to select [QUIT] in the user options area then push the knob.

## 11.7 NBDP Terminal Unit Maintenance

Regular maintenance is important for good performance. A regular maintenance program should be established and should at least include the items mentioned below.

### 11.7.1 Cleaning the equipment

Wipe the LCD carefully to prevent scratching, using tissue paper and an LCD cleaner. To remove dirt or salt deposits, use an LCD cleaner, wiping slowly with tissue paper so as to dissolve the dirt or salt. Change paper frequently so the salt or dirt does not scratch the LCD. Do not use solvents such as thinner, acetone or benzene for cleaning. Also, do not use degreaser or antifog solution, as they can strip the coating from the LCD.

### 11.7.2 Connectors and earth connection

Periodically check the connectors for proper seating and the earth connection for rust. Remove rust to maintain a good ground system.

### 11.7.3 Diagnostics

#### General diagnostics

1. Press the function key **F6** to open the [System] menu.

System	
Setup	Lock Change Default
Slave Delay	xx msec (10 - 50 msec)
TX/RX MSG Save	OFF ON
Edit Before sending	OFF ON
TX POWER	HIGH MID LOW
Header/Footer	OFF ON
Time System	OFF UTC SMT JST
Date & Time	10-Apr-2012 10:00:00
Window Color	
Self Test	

For serviceman

No need to change. Only serviceman can change.

2. Select [Change] at [Setup].
3. Select [Self Test] at the bottom of the screen.

4. Press the **Enter** key. The results of the self test are displayed a short time later.

Selftest	
Date & Time	: 10-Apr-2012 20:45:30
Software Ver	: 0550251-01.XX
Starter Ver	: 0550252-01.XX
Main Unit Name	: FS-xx75
Main Unit Ver	: 0550243-01.XX
Memory Test	: OK
SD Card Test* <sup>1</sup>	: OK
SIO Test* <sup>2</sup>	: OK
Printer Test* <sup>3</sup>	: Done
USB Test* <sup>4</sup>	:

XX: Version No.  
 xx: FS-1575, FS-2575 or FS-5075  
 \*1: "NG" when the SD card is not inserted.  
 \*2: "NG" when FS-xx75 is turned off.  
 \*3: "NG" and "Printer not ready" when printer is off or abnormal.  
 \*4: The message "Press 3 keys" appears. Press any three keys.

#### Selftest results

#### **Self test results**

The test results are shown as [OK] or [NG] (No Good). For any [NG], check the connection of the equipments then try the self test again. If it appears again, call for service. When the test is completed, the message "Selftest Completed. Press any key to escape." appears.

### 11.7.4 Power fuse

If you can not turn on the power for the terminal unit, check the power fuse. If the fuse has blown, replace the fuse (Type: FGBO-A 125V 3A PBF). If the fuse blows again after replacement, request service.

### 11.7.5 Notification messages

Notification message	Meaning	Remedy
Caution: This Editor cannot edit over 16Kbytes	Can not edit the files over 16 kilobytes.	Can not open the files over 16 kilobytes. Delete unnecessary characters so that the file size is less than 16 kilobytes.
Station by that name already exists.	The station name already exists.	Change the station name.
Station memory is full.	The station memory is full.	Delete unnecessary stations.
Scan group by that name already exists.	The scan group name already exists.	Change the scan group name.
Scan group by that name does not exist.	The scan group name does not exist.	Check the scan group name.
Scan group memory is full.	The scan group memory is full.	Delete unnecessary scan groups.
Channel by that number does not exist.	The channel number does not exist.	Check the channel number.
Operation name already exists.	The timer operation name already exists.	Change the timer operation name.
Timer operation memory is full.	The timer operation memory is full.	Delete unnecessary timer operations.

11. MAINTENANCE & TROUBLESHOOTING

Notification message	Meaning	Remedy
Device Access Error	The device access fails.	The data can be corrupted because picking up the SD card on access. Before picking up the SD card, execute [Remove SD Card] from the [File] menu.
File Write Error (Write Protecting)	The writing on the file fails. The file is write-protect status.	Awake the write-protect for the SD card.
File Open Error (Already Opened)	The file is already opened.	-
File Open Error (Max Open)	The number of the opened files is over the specified number.	Close an opened file.
File Open Error (File not Found)	The file does not exist.	Check the file name.
File Open Error (File Exist)	The file has already existed.	Change the file name.
SD Card Format failed.	The format of the SD card fails.	Check the SD card.
File not found. '[file name]'	The file name could not be found.	Check the file name.
Card full.	The capacity of the SD card is full.	Change the SD card or delete unnecessary files.
Check interconnections between terminal and Main. Set SMT for stand-alone use.	Check the connection between the terminal unit and the transceiver unit. Set the SMT for the stand-alone use.	Check if the transceiver unit is on. Check the connection between the terminal unit and the transceiver unit. For the stand-alone use for IB-585, set the time in the [System] menu.
Cannot print. Check connection between printer and terminal.	You tried to print but something is wrong with the printer.	Check if the printer is on. Check the connection between the printer and the terminal unit. Check the remaining amount of the roll paper.
Selected file is not macro.	The selected file is not a macro file.	Select a file with ".mcr" extension.
Macro command error.	The macro command is illegal.	Check the macro command.
Wait one minute before calling again after failed.	If a call could not be made, wait a minute before calling again. In the ARQ mode the line is automatically disconnected when there is no reply from the called party. Wait one minute then try the call again.	-
OCCUPIED.	The transceiver unit has priority.	Can not operate the NBDP terminal unit because of in operation of the transceiver unit. Switch the transceiver unit to the RT screen.



# APPENDIX 1 MENU TREE

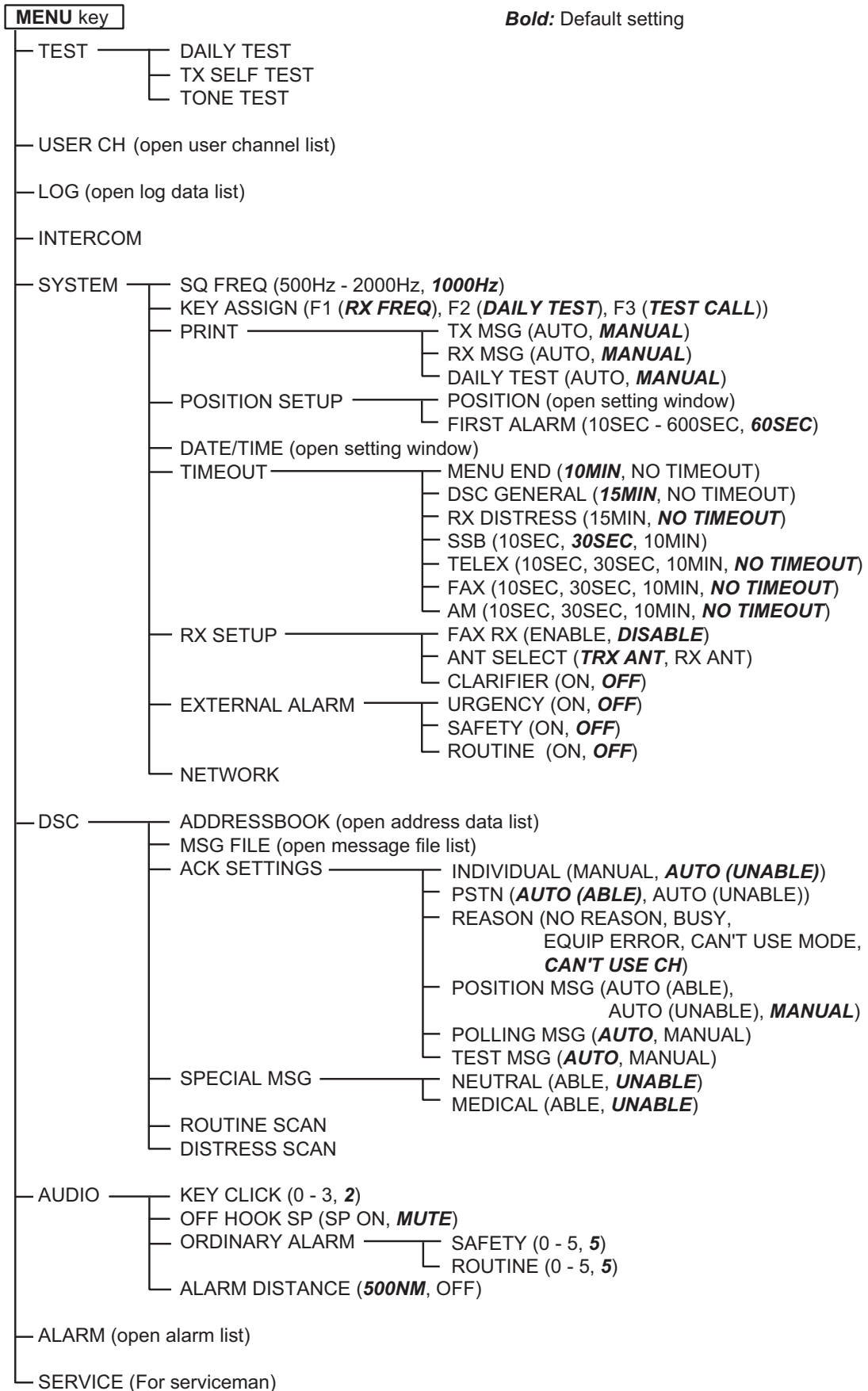

NBDP terminal unit (telex)

F1: File

- 1: New
- 2: Open
- 3: Close
- 4: Delete
- 5: Rename
- 6: Real Time Printing
- 7: File to Print
- 8: Cancel Printing
- 9: Clear Buffer
- 0: SD Card Format
- A: Remove SD Card
- B: New Macro

F2: Edit

- 1: Undo
- 2: Cut
- 3: Copy
- 4: Paste
- 5: Select All
- 6: Search
- 7: Replace
- 8: Goto Top
- 9: Goto Bottom
- 0: Goto Line
- A: Change Text

F3: Operate

- 1: Call Station
- 2: Macro Operation
- 3: File to Send
- 4: Cancel Sending
- 5: Scan (Start/Stop)
- 6: Manual Reception
- 7: Timer Operation
- 8: Manual Calling
- 9: Set Frequency
- 0: Set Channel

F4: Window

- 1: Calendar
- 2: Distress Frequency Table
- 3: Screen Saver (**OFF**, ON)

F5: Station

- 1: Station Entry
- 2: Timer Operation (Entry)
- 3: Scan Entry
- 4: Answerback Code Entry
- 5: Group ID Entry (4/5 digit)
- 6: Group ID Entry (9 digit)
- 7: Select ID Entry (4/5 digit)
- 8: Select ID Entry (9 digit)

F6: System

- Setup (**Lock**, Change, Default)
- Slave Delay (10-50 msec, **12**)
- TX/RX MSG Save (**OFF**, ON)
- Edit Before Sending (**OFF**, ON)
- TX Power (**HIGH**, MID, LOW\*<sup>1</sup>, (LOW1, LOW2)\*<sup>2</sup>)
- Header/Footer (**OFF**, ON)
- Time System (OFF, **UTC**, SMT, JST)
- Date & Time
- Window Color
  - Window Color Change
  - Select Preset (1, 2, 3)
  - Load Default
  - Window — BASE WINDOW, BACK SCROLL, EDIT 1-2, FUNCTION, SUB MENU 1-3, MESSAGE
  - Fore Color } WHITE, BLACK, L-WHITE, GRAY,
  - Back Color } L-BLUE, BLUE, L-GREEN, GREEN, L-CYAN, CYAN, L-RED, RED, L-MAGENTA, MAGENTA, L-YELLOW, YELLOW
  - Brightness (0 - 10, **10**)
- Self Test

**Bold:** Default setting

\*1: For FS-1575/2575  
\*2: For FS-5075

F7: WRU (Who are you?)

F10: Break

F8: HR (Here is)

F11: Setup (For serviceman)

F9: Over

# APPENDIX 2 FREQUENCY TABLES

## DSC frequency table

TX (kHz)	RX (kHz)	Remarks	File Name
2187.5	2187.5	Distress and Safety Frequencies	
4207.5	4207.5		
6312.0	6312.0		
8414.5	8414.5		
12577.0	12577.0		
16804.5	16804.5		
2189.5 (2177.0*)	2177.0	International Frequencies	INTL-2M
4208.0	4219.5		INTL-4M
6312.5	6331.0		INTL-6M
8415.0	8436.5		INTL-8M
12577.5	12657.0		INTL-12M
16805.0	16903.0		INTL-16M
18898.5	19703.5		INTL-18M
22374.5	22444.0		INTL-22M
25208.5	26121.0		INTL-25M
4208.5	4220.0	Local-1 Frequencies	LOCAL1-4M
6313.0	6331.5		LOCAL1-6M
8415.5	8437.0		LOCAL1-8M
12578.0	12657.5		LOCAL1-12M
16805.5	16903.5		LOCAL1-16M
18899.0	19704.0		LOCAL1-18M
22375.0	22444.5		LOCAL1-22M
25209.0	26121.5		LOCAL1-25M
4209.0	4220.5	Local-2 Frequencies	LOCAL2-4M
6313.5	6332.0		LOCAL2-6M
8416.0	8437.5		LOCAL2-8M
12578.5	12658.0		LOCAL2-12M
16806.0	16904.0		LOCAL2-16M
18899.5	19704.5		LOCAL2-18M
22375.5	22445.0		LOCAL2-22M
25209.5	26122.0		LOCAL2-25M

\*: Ship-to-ship

APPENDIX 2 FREQUENCY TABLES

Custom channels (to be programmed by FURUNO dealers)

CH NO	Ship Receive (kHz)	Ship Transmit (kHz)	Remarks

MF band working carrier frequencies (ref. US CFR 47 Part 80.371)

Region	Ship Transmit (kHz)	Ship Receive (kHz)	Region	Ship Transmit (kHz)	Ship Receive (kHz)
East Coast	2031.5	2490.0	Gulf Coast	2009.0	2466.0
	2118.0	2514.0 <sup>1</sup>		2134.0	2530.0
	2126.0	2522.0		2142.0	2538.0
	2142.0	2538.0		2158.0 <sup>1</sup>	2550.0 <sup>1</sup>
	2166.0	2558.0		2166.0	2558.0
	2198.0	2590.0		2206.0	2598.0
	2366.0	2450.0		2366.0	2450.0
	2382.0	2482.0		2382.0	2482.0
	2390.0	2566.0		2430.0	2572.0
	2400.0	2400.0		2458.0	2506.0
	2406.0	2506.0			
West Coast	2003.0	2450.0	Great Lakes <sup>2</sup>	2118.0	2514.0
	2009.0	2442.0		2158.0	2550.0
	2009.0	2566.0		2206.0	2582.0
	2031.5	2566.0	Alaska	2131.0	2309.0
	2126.0	2522.0		2134.0	2312.0
	2206.0	2598.0		2237.0	2397.0
	2382.0	2466.0		2240.0	2400.0
	2406.0	2506.0	Hawaii	2134.0	2530.0
	2430.0	2482.0	Caribbean	2009.0	2506.0
				2086.0 <sup>3</sup>	2585.0
				2134.0	2530.0
		Guam	2009.0	2506.0	

Above frequencies are not programmed. Contact a FURUNO representative.

1 = Unlimited use December 15 to April 1

2 = 2206 kHz for distress only

3 = Limited to pep of 150 W

APPENDIX 2 FREQUENCY TABLES

MF band SSB working carrier frequencies

CH NO	Ship Receive (kHz)	Ship Transmit (kHz)
241	1635	2060
242	1638	2063
243	1641	2066
244	1644	2069
245	1647	2072
246	1650	2075
247	1653	2078
248	1656	2081
249	1659	2084
250	1662	2087
251	1665	2090
252	1668	2093
253	1671	2096
254	1674	2099
255	1677	2102
256	1680	2105
257	1683	2108
258	1686	2111
259	1689	2114
260	1692	2117
261	1695	2120
262	1698	2123
263	1701	2126
264	1704	2129
265	1707	2132
266	1710	2135
267	1713	2138
268	1716	2060
269	1719	2063
270	1722	2066

CH NO	Ship Receive (kHz)	Ship Transmit (kHz)
271	1725	2069
272	1728	2072
273	1731	2075
274	1734	2078
275	1737	2081
276	1740	2084
277	1743	2087
278	1746	2090
279	1749	2093
280	1752	2096
281	1755	2099
282	1758	2102
283	1761	2105
284	1764	2108
285	1767	2111
286	1770	2114
287	1773	2117
288	1776	2120
289	1779	2123
290	1782	2126
291	1785	2129
292	1788	2132
293	1791	2135
294	1794	2138
295	1797	2060

4/6 MHz ITU SSB carrier frequencies (ITU RR Appendix 16)

4 MHz SSB (J3E)		
ITU CH NO	Ship RX	Ship TX
401	4357	4065
402	4360	4068
403	4363	4071
404	4366	4074
405	4369	4077
406	4372	4080
407	4375	4083
408	4378	4086
409	4381	4089
410	4384	4092
411	4387	4095
412	4390	4098
413	4393	4101
414	4396	4104
415	4399	4107
416	4402	4110
417	4405	4113
418	4408	4116
419	4411	4119
420	4414	4122
421	4417	4125
422	4420	4128
423	4423	4131
424	4426	4134
425	4429	4137
426	4432	4140
427	4435	4143
428* <sup>1</sup>	4351	-
429* <sup>1</sup>	4354	-
430* <sup>2</sup>	4146	4146
431* <sup>2</sup>	4149	4149
432 (01)	4000	4000
433 (02)	4003	4003
434 (03)	4006	4006
435 (04)	4009	4009
436 (05)	4012	4012
437 (06)	4015	4015
438 (07)	4018	4018
439 (08)	4021	4021
440 (09)	4024	4024
441 (10)	4027	4027
442 (11)	4030	4030
443 (12)	4033	4033
444 (13)	4036	4036
445 (14)	4039	4039
446 (15)	4042	4042
447 (16)	4045	4045
448 (17)	4048	4048
449 (18)	4051	4051
450 (19)	4054	4054
451 (20)	4057	4057
452 (21)	4060	4060

6 MHz SSB (J3E)		
ITU CH NO	Ship RX	Ship TX
601	6501	6200
602	6504	6203
603	6507	6206
604	6510	6209
605	6513	6212
606	6516	6215
607	6519	6218
608	6522	6221
609	6224	6224
610	6227	6227
611	6230	6230

These frequencies are factory programmed.

\*<sup>1</sup>: These channels are paired with ship station's simplex frequencies and used for duplex operation.

\*<sup>2</sup>: These channels are from ITU RR Section B.

CH NOs in ( ) are ITU NOs (RR Section C-1).

8 MHz ITU SSB carrier frequencies (ITU RR Appendix 16)

8 MHz SSB (J3E) - Duplex		
ITU CH NO	Ship RX	Ship TX
801	8719	8195
802	8722	8198
803	8725	8201
804	8728	8204
805	8731	8207
806	8734	8210
807	8737	8213
808	8740	8216
809	8743	8219
810	8746	8222
811	8749	8225
812	8752	8228
813	8755	8231
814	8758	8234
815	8761	8237
816	8764	8240
817	8767	8243
818	8770	8246
819	8773	8249
820	8776	8252
821	8779	8255
822	8782	8258
823	8785	8261
824	8788	8264
825	8791	8267
826	8794	8270
827	8797	8273
828	8800	8276
829	8803	8279
830	8806	8282
831	8809	8285
832	8812	8288
833	8291	8291
834* <sup>1</sup>	8707	-
835* <sup>1</sup>	8710	-
836* <sup>1</sup>	8713	-
837* <sup>1</sup>	8716	-
838* <sup>2</sup>	8294	8294
839* <sup>2</sup>	8297	8297

8 MHz SSB (J3E) - Simplex		
ITU CH NO	Ship RX	Ship TX
840 (01)	8101	8101
841 (02)	8104	8104
842 (03)	8107	8107
843 (04)	8110	8110
844 (05)	8113	8113
845 (06)	8116	8116
846 (07)	8119	8119
847 (08)	8122	8122
848 (09)	8125	8125
849 (10)	8128	8128
850 (11)	8131	8131
851 (12)	8134	8134
852 (13)	8137	8137
853 (14)	8140	8140
854 (15)	8143	8143
855 (16)	8146	8146
856 (17)	8149	8149
857 (18)	8152	8152
858 (19)	8155	8155
859 (20)	8158	8158
860 (21)	8161	8161
861 (22)	8164	8164
862 (23)	8167	8167
863 (24)	8170	8170
864 (25)	8173	8173
865 (26)	8176	8176
866 (27)	8179	8179
867 (28)	8182	8182
868 (29)	8185	8185
869 (30)	8188	8188
870 (31)	8191	8191
CH NOs in ( ) are ITU NOs (RR Section C-1).		

\*1: These channels are paired with ship station's simplex frequencies and used for duplex operation.

\*2: These channels are from ITU RR Section B.



12/16 ITU SSB carrier frequencies (ITU RR Appendix 16)

12 MHz SSB (J3E)			16 MHz SSB (J3E)			16 MHz SSB (J3E)		
CH NO	Ship RX	Ship TX	CH NO	Ship RX	Ship TX	CH NO	Ship RX	Ship TX
1201	13077	12230	1601	17242	16360	1651	17392	16510
1202	13080	12233	1602	17245	16363	1652	17395	16513
1203	13083	12236	1603	17248	16366	1653	17398	16516
1204	13086	12239	1604	17251	16369	1654	17401	16519
1205	13089	12242	1605	17254	16372	1655	17404	16522
1206	13092	12245	1606	17257	16375	1656	17407	16525
1207	13095	12248	1607	17260	16378	1657*1	16528	16528
1208	13098	12251	1608	17263	16381	1658*1	16531	16531
1209	13101	12254	1609	17266	16384	1659*1	16534	16534
1210	13104	12257	1610	17269	16387	1660*1	-	-
1211	13107	12260	1611	17272	16390	1661*1	16540	16540
1212	13110	12263	1612	17275	16393	1662*1	16543	16543
1213	13113	12266	1613	17278	16396	1663*1	16546	16546
1214	13116	12269	1614	17281	16399			
1215	13119	12272	1615	17284	16402			
1216	13122	12275	1616	17287	16405			
1217	13125	12278	1617	17290	16408			
1218	13128	12281	1618	17293	16411			
1219	13131	12284	1619	17296	16414			
1220	13134	12287	1620	17299	16417			
1221	13137	12290	1621	17302	16420			
1222	13140	12293	1622	17305	16423			
1223	13143	12296	1623	17308	16426			
1224	13146	12299	1624	17311	16429			
1225	13149	12302	1625	17314	16432			
1226	13152	12305	1626	17317	16435			
1227	13155	12308	1627	17320	16438			
1228	13158	12311	1628	17323	16441			
1229	13161	12314	1629	17326	16444			
1230	13164	12317	1630	17329	16447			
1231	13167	12320	1631	17332	16450			
1232	13170	12323	1632	17335	16453			
1233	13173	12326	1633	17338	16456			
1234	13176	12329	1634	17341	16459			
1235	13179	12332	1635	17344	16462			
1236	13182	12335	1636	17347	16465			
1237	13185	12338	1637	17350	16468			
1238	13188	12341	1638	17353	16471			
1239	13191	12344	1639	17356	16474			
1240	13194	12347	1640	17359	16477			
1241	13197	12350	1641	17362	16480			
1242*1	12353	12353	1642	17365	16483			
1243*1	12356	12356	1643	17368	16486			
1244*1	-	-	1644	17371	16489			
1245*1	12362	12362	1645	17374	16492			
1246*1	12365	12365	1646	17377	16495			
			1647	17380	16498			
			1648	17383	16501			
			1649	17386	16504			
			1650	17389	16507			

\*1: These channels are from ITU RR Section B.

Above is factory programmed.

18/19, 22, 25/26 ITU SSB carrier frequencies (ITU RR Appendix 16)

18/19 MHz SSB (J3E)		
CH NO	Ship RX	Ship TX
1801	19755	18780
1802	19758	18783
1803	19761	18786
1804	19764	18789
1805	19767	18792
1806	19770	18795
1807	19773	18798
1808	19776	18801
1809	19779	18804
1810	19782	18807
1811	19785	18810
1812	19788	18813
1813	19791	18816
1814	19794	18819
1815	19797	18822
1816*1	18825	18825
1817*1	18828	18828
1818*1	18831	18831
1819*1	18834	18834
1820*1	18837	18837
1821*1	18840	18840
1822*1	18843	18843

\*1: These channels are from ITU RR Section B.

22 MHz SSB (J3E)		
CH NO	Ship RX	Ship TX
2201	22696	22000
2202	22699	22003
2203	22702	22006
2204	22705	22009
2205	22708	22012
2206	22711	22015
2207	22714	22018
2208	22717	22021
2209	22720	22024
2210	22723	22027
2211	22726	22030
2212	22729	22033
2213	22732	22036
2214	22735	22039
2215	22738	22042
2216	22741	22045
2217	22744	22048
2218	22747	22051
2219	22750	22054
2220	22753	22057
2221	22756	22060
2222	22759	22063
2223	22762	22066
2224	22765	22069
2225	22768	22072
2226	22771	22075
2227	22774	22078
2228	22777	22081
2229	22780	22084
2230	22783	22087
2231	22786	22090
2232	22789	22093
2233	22792	22096
2234	22795	22099
2235	22798	22102
2236	22801	22105
2237	22804	22108
2238	22807	22111
2239	22810	22114
2240	22813	22117
2241	22816	22120
2242	22819	22123
2243	22822	22126
2244	22825	22129
2245	22828	22132
2246	22831	22135
2247	22834	22138
2248	22837	22141
2249	22840	22144
2250	22843	22147

22 MHz SSB (J3E)		
CH NO	Ship RX	Ship TX
2251	22846	22150
2252	22849	22153
2253	22852	22156
2254*1	22159	22159
2255*1	22162	22162
2256*1	22165	22165
2257*1	22168	22168
2258*1	22171	22171
2259*1	22174	22174
2260*1	22177	22177

25/26 MHz SSB (J3E)		
CH NO	Ship RX	Ship TX
2501	26145	25070
2502	26148	25073
2503	26151	25076
2504	26154	25079
2505	26157	25082
2506	26160	25085
2507	26163	25088
2508	26166	25091
2509	26169	25094
2510	26172	25097
2511*1	25100	25100
2512*1	25103	25103
2513*1	25106	25106
2514*1	25109	25109
2515*1	25112	25112
2516*1	25115	25115
2517*1	25118	25118

MF band telex frequency table

CH NO	Ship TX (NBDP, DSC)	Ship RX (NBDP, DSC)	
2001	2142.0	1607.0	NBDP/DSC
2002	2142.5	1607.5	
2003	2143.0	1608.0	
2004	2143.5	1608.5	
2005	2144.0	1609.0	
2006	2144.5	1609.5	
2007	2145.0	1610.0	
2008	2145.5	1610.5	
2009	2146.0	1611.0	
2010	2146.5	1611.5	
2011	2147.0	1612.0	
2012	2147.5	1612.5	
2013	2148.0	1613.0	
2014	2148.5	1613.5	
2015	2149.0	1614.0	
2016	2149.5	1614.5	
2017	2150.0	1615.0	
2018	2150.5	1615.5	
2019	2151.0	1616.0	
2020	2151.5	1616.5	
2021	2152.0	1617.0	
2022	2152.5	1617.5	
2023	2153.0	1618.0	
2024	2153.5	1618.5	
2025	2154.0	1619.0	
2026	2154.5	1619.5	
2027	2155.0	1620.0	
2028	2155.5	1620.5	
2029	2156.0	1621.0	
2030	2156.5	1621.5	
2031	2157.0	1622.0	DSC
2032	2157.5	1622.5	
2033	2158.0	1623.0	
2034	2158.5	1623.5	
2035	2159.0	1624.0	
2036	2159.5	1624.5	

APPENDIX 2 FREQUENCY TABLES

ITU Telex frequency table (1/4)

∗: For WRC-7, ∗∗: For WRC-12

ITU TELEX FREQUENCY TABLE (1/4)

4 MHz BAND			6 MHz BAND			8 MHz BAND			12 MHz BAND			16 MHz BAND			1819 MHz BAND			22 MHz BAND			25/26 MHz BAND								
No.	TX	RX	No.	TX	RX	No.	TX	RX	No.	TX	RX	No.	TX	RX	No.	TX	RX	No.	TX	RX	No.	TX	RX	No.	TX	RX			
4001	4172.5	4210.5	6001	6263.0	6314.5	8001	8376.5	8417.0	12001	12477.0	12579.5	16001	16683.5	16807.0	18001	18870.5	19681.0	22001	22824.5	23376.5	25001	25173.0	26101.0						
4002	4173.0	4211.0	6002	6263.5	6315.0	8002	8377.0	8417.5	12002	12477.5	12580.0	16002	16684.0	16807.5	18002	18871.0	19681.5	22002	22825.0	23377.0	25002	25173.5	26101.5						
4003	4173.5	4211.5	6003	6264.0	6315.5	8003	8377.5	8418.0	12003	12478.0	12580.5	16003	16684.5	16808.0	18003	18871.5	19682.0	22003	22825.5	23377.5	25003	25174.0	26102.0						
4004	4174.0	4212.0	6004	6264.5	6316.0	8004	8378.0	8418.5	12004	12478.5	12581.0	16004	16685.0	16808.5	18004	18872.0	19682.5	22004	22826.0	23378.0	25004	25174.5	26102.5						
4005	4174.5	4212.5	6005	6265.0	6316.5	8005	8378.5	8419.0	12005	12479.0	12581.5	16005	16685.5	16809.0	18005	18872.5	19683.0	22005	22826.5	23378.5	25005	25175.0	26103.0						
4006	4175.0	4213.0	6006	6265.5	6317.0	8006	8379.0	8419.5	12006	12479.5	12582.0	16006	16686.0	16809.5	18006	18873.0	19683.5	22006	22827.0	23379.0	25006	25175.5	26103.5						
4007	4175.5	4213.5	6007	6266.0	6317.5	8007	8379.5	8420.0	12007	12480.0	12582.5	16007	16686.5	16810.0	18007	18873.5	19684.0	22007	22827.5	23379.5	25007	25176.0	26104.0						
4008	4176.0	4214.0	6008	6266.5	6318.0	8008	8380.0	8420.5	12008	12480.5	12583.0	16008	16687.0	16810.5	18008	18874.0	19684.5	22008	22828.0	23380.0	25008	25176.5	26104.5						
4009	4176.5	4214.5	6009	6267.0	6318.5	8009	8380.5	8421.0	12009	12481.0	12583.5	16009	16687.5	16811.0	18009	18874.5	19685.0	22009	22828.5	23380.5	25009	25177.0	26105.0						
4010	4177.0	4215.0	6010	6267.5	6319.0	8010	8381.0	8421.5	12010	12481.5	12584.0	16010	16688.0	16811.5	18010	18875.0	19685.5	22010	22829.0	23381.0	25010	25177.5	26105.5						
4011	4177.5	4215.5	6011	6268.0	6319.5	8011	8381.5	8422.0	12011	12482.0	12584.5	16011	16688.5	16812.0	18011	18875.5	19686.0	22011	22829.5	23381.5	25011	25178.0	26106.0						
4012	4178.0	4216.0	6012	6268.5	6320.0	8012	8382.0	8422.5	12012	12482.5	12585.0	16012	16689.0	16812.5	18012	18876.0	19686.5	22012	22830.0	23382.0	25012	25178.5	26106.5						
4013	4178.5	4216.5	6013	6269.0	6320.5	8013	8382.5	8423.0	12013	12483.0	12585.5	16013	16689.5	16813.0	18013	18876.5	19687.0	22013	22830.5	23382.5	25013	25179.0	26107.0						
4014	4179.0	4217.0	6014	6269.5	6321.0	8014	8383.0	8423.5	12014	12483.5	12586.0	16014	16690.0	16813.5	18014	18877.0	19687.5	22014	22831.0	23383.0	25014	25179.5	26107.5						
4015	4179.5	4217.5	6015	6270.0	6321.5	8015	8383.5	8424.0	12015	12484.0	12586.5	16015	16690.5	16814.0	18015	18877.5	19688.0	22015	22831.5	23383.5	25015	25180.0	26108.0						
4016	4180.0	4218.0	6016	6270.5	6322.0	8016	8384.0	8424.5	12016	12484.5	12587.0	16016	16691.0	16814.5	18016	18878.0	19688.5	22016	22832.0	23384.0	25016	25180.5	26108.5						
4017	4180.5	4218.5	6017	6271.0	6322.5	8017	8384.5	8425.0	12017	12485.0	12587.5	16017	16691.5	16815.0	18017	18878.5	19689.0	22017	22832.5	23384.5	25017	25181.0	26109.0						
4018	4181.0	4219.0	6018	6271.5	6323.0	8018	8385.0	8425.5	12018	12485.5	12588.0	16018	16692.0	16815.5	18018	18879.0	19689.5	22018	22833.0	23385.0	25018	25181.5	26109.5						
4019	4181.5	4219.5	6019	6272.0	6323.5	8019	8385.5	8426.0	12019	12486.0	12588.5	16019	16692.5	16816.0	18019	18879.5	19690.0	22019	22833.5	23385.5	25019	25182.0	26110.0						
4020	4202.5	4202.5	6020	6272.5	6324.0	8020	8386.0	8426.5	12020	12486.5	12589.0	16020	16693.0	16816.5	18020	18880.0	19690.5	22020	22834.0	23386.0	25020	25182.5	26110.5						
4021	4203.0	4203.0	6021	6273.0	6324.5	8021	8386.5	8427.0	12021	12487.0	12589.5	16021	16693.5	16817.0	18021	18880.5	19691.0	22021	22834.5	23386.5	25021	25183.0	26111.0						
4022	4203.5	4203.5	6022	6273.5	6325.0	8022	8387.0	8427.5	12022	12487.5	12590.0	16022	16694.0	16817.5	18022	18881.0	19691.5	22022	22835.0	23387.0	25022	25183.5	26111.5						
4023	4204.0	4204.0	6023	6274.0	6325.5	8023	8387.5	8428.0	12023	12488.0	12590.5	16023	16694.5	16818.0	18023	18881.5	19692.0	22023	22835.5	23387.5	25023	25184.0	26112.0						
4024	4204.5	4204.5	6024	6274.5	6326.0	8024	8388.0	8428.5	12024	12488.5	12591.0	16024	16695.0	16818.5	18024	18882.0	19692.5	22024	22836.0	23388.0	25024	25184.5	26112.5						
4025	4205.0	4205.0	6025	6275.0	6326.5	8025	8388.5	8429.0	12025	12489.0	12591.5	16025	16695.5	16819.0	18025	18882.5	19693.0	22025	22836.5	23388.5	25025	25185.0	26113.0						
4026	4205.5	4205.5	6026	6275.5	6327.0	8026	8389.0	8429.5	12026	12489.5	12592.0	16026	16696.0	16819.5	18026	18883.0	19693.5	22026	22837.0	23389.0	25026	25185.5	26113.5						
4027	4206.0	4206.0	6027	6276.0	6327.5	8027	8389.5	8430.0	12027	12490.0	12592.5	16027	16696.5	16820.0	18027	18883.5	19694.0	22027	22837.5	23389.5	25027	25186.0	26114.0						
4028	4206.5	4206.5	6028	6276.5	6328.0	8028	8390.0	8430.5	12028	12490.5	12593.0	16028	16697.0	16820.5	18028	18884.0	19694.5	22028	22838.0	23390.0	25028	25186.5	26114.5						
4029	4207.0	4207.0	6029	6277.0	6328.5	8029	8390.5	8431.0	12029	12491.0	12593.5	16029	16697.5	16821.0	18029	18884.5	19695.0	22029	22838.5	23390.5	25029	25187.0	26115.0						
4030	4207.5	4207.5	6030	6277.5	6329.0	8030	8391.0	8431.5	12030	12491.5	12594.0	16030	16698.0	16821.5	18030	18885.0	19695.5	22030	22839.0	23391.0	25030	25187.5	26115.5						
4031	4208.0	4208.0	6031	6278.0	6329.5	8031	8391.5	8432.0	12031	12492.0	12594.5	16031	16698.5	16822.0	18031	18885.5	19696.0	22031	22839.5	23391.5	25031	25188.0	26116.0						
4032	4208.5	4208.5	6032	6278.5	6330.0	8032	8392.0	8432.5	12032	12492.5	12595.0	16032	16699.0	16822.5	18032	18886.0	19696.5	22032	22840.0	23392.0	25032	25188.5	26116.5						
4033	4209.0	4209.0	6033	6279.0	6330.5	8033	8392.5	8433.0	12033	12493.0	12595.5	16033	16699.5	16823.0	18033	18886.5	19697.0	22033	22840.5	23392.5	25033	25189.0	26117.0						
4034	4209.5	4209.5	6034	6279.5	6331.0	8034	8393.0	8433.5	12034	12493.5	12596.0	16034	16700.0	16823.5	18034	18887.0	19697.5	22034	22841.0	23393.0	25034	25189.5	26117.5						
4035	4210.0	4210.0	6035	6280.0	6331.5	8035	8393.5	8434.0	12035	12494.0	12596.5	16035	16700.5	16824.0	18035	18887.5	19698.0	22035	22841.5	23393.5	25035	25190.0	26118.0						
4036	4210.5	4210.5	6036	6280.5	6332.0	8036	8394.0	8434.5	12036	12494.5	12597.0	16036	16701.0	16824.5	18036	18888.0	19698.5	22036	22842.0	23394.0	25036	25190.5	26118.5						
4037	4211.0	4211.0	6037	6281.0	6332.5	8037	8394.5	8435.0	12037	12495.0	12597.5	16037	16701.5	16825.0	18037	18888.5	19699.0	22037	22842.5	23394.5	25037	25191.0	26119.0						
4038	4211.5	4211.5	6038	6281.5	6333.0	8038	8395.0	8435.5	12038	12495.5	12598.0	16038	16702.0	16825.5	18038	18889.0	19699.5	22038	22843.0	23395.0	25038	25191.5	26119.5						
4039	4212.0	4212.0	6039	6282.0	6333.5	8039	8395.5	8436.0	12039	12496.0	12598.5	16039	16702.5	16826.0	18039	18889.5	19700.0	22039	22843.5	23395.5	25039	25192.0	26120.0						
4																													

# ITU Telex frequency table (2/4)

\*: For WRC-7, \*\*: For WRC-12

ITU TELEX FREQUENCY TABLE (2/4)

4 MHz BAND				6 MHz BAND				8 MHz BAND				12 MHz BAND				16 MHz BAND				18/19 MHz BAND				22 MHz BAND				25/26 MHz BAND			
No.	TX	RX	No.	TX	RX	No.	TX	RX	No.	TX	RX	No.	TX	RX	No.	TX	RX	No.	TX	RX	No.	TX	RX	No.	TX	RX	No.	TX	RX		
8066*			8409.0			8409.0			12066			12066			12066			16176.0			22066*			22066*			25066*				
8067*			8409.5			8409.5			12067			12067			12067			16176.5			22067*			22067*			25067*				
8068*			8410.0			8410.0			12068			12068			12068			16177.0			22068*			22068*			25068*				
8069*			8410.5			8410.5			12069			12069			12069			16177.5			22069*			22069*			25069*				
8070*			8411.0			8411.0			12070			12070			12070			16178.0			22070*			22070*			25070*				
8071*			8411.5			8411.5			12071			12071			12071			16178.5			22071*			22071*			25071*				
8072*			8412.0			8412.0			12072			12072			12072			16179.0			22072*			22072*			25072*				
8073*			8412.5			8412.5			12073			12073			12073			16179.5			22073*			22073*			25073*				
8074*			8413.0			8413.0			12074			12074			12074			16180.0			22074*			22074*			25074*				
8075*			8413.5			8413.5			12075			12075			12075			16180.5			22075*			22075*			25075*				
8076*			8414.0			8414.0			12076			12076			12076			16181.0			22076*			22076*			25076*				
8077			8414.5			8414.5			12077			12077			12077			16181.5			22077*			22077*			25077*				
8078			8415.0			8415.0			12078			12078			12078			16182.0			22078*			22078*			25078*				
8079			8415.5			8415.5			12079			12079			12079			16182.5			22079*			22079*			25079*				
8080			8416.0			8416.0			12080			12080			12080			16183.0			22080*			22080*			25080*				
8081**			8339.25			8339.25			12081			12081			12081			16183.5			22081*			22081*			25081*				
8082**			8339.75			8339.75			12082			12082			12082			16184.0			22082*			22082*			25082*				
8083**			8375.0			8375.0			12083			12083			12083			16184.5			22083*			22083*			25083*				
8084**			8375.5			8375.5			12084			12084			12084			16185.0			22084*			22084*			25084*				
8085**			8376.0			8376.0			12085			12085			12085			16185.5			22085*			22085*			25085*				

APPENDIX 2 FREQUENCY TABLES

ITU Telex frequency table (3/4)

\*: For WRC-7, \*\*: For WRC-12

**FURUND** **ITU TELEX FREQUENCY TABLE (3/4)**

4 MHz BAND			6 MHz BAND			8 MHz BAND			12 MHz BAND			16 MHz BAND			1819 MHz BAND			22 MHz BAND			25/26 MHz BAND			
No.	TX	RX	No.	TX	RX	No.	TX	RX	No.	TX	RX	No.	TX	RX	No.	TX	RX	No.	TX	RX	No.	TX	RX	
12131*	12542.0	12644.0	16131*	16753.0	16871.5	12131*	12542.5	12644.5	16131*	16753.5	16872.0	22131*	22349.5	22441.5	22131*	22349.5	22441.5	22131*	22349.5	22441.5	22131*	22349.5	22441.5	
12132*	12542.5	12644.5	16132*	16754.0	16872.0	12132*	12543.0	12645.0	16132*	16754.5	16872.5	22132*	22350.0	22442.0	22132*	22350.0	22442.0	22132*	22350.0	22442.0	22132*	22350.0	22442.0	
12133*	12543.0	12645.0	16133*	16754.5	16872.5	12133*	12543.5	12645.5	16133*	16755.0	16873.0	22133*	22350.5	22442.5	22133*	22350.5	22442.5	22133*	22350.5	22442.5	22133*	22350.5	22442.5	
12134*	12543.5	12645.5	16134*	16755.0	16873.0	12134*	12544.0	12646.0	16134*	16755.5	16873.5	22134*	22351.0	22443.0	22134*	22351.0	22443.0	22134*	22351.0	22443.0	22134*	22351.0	22443.0	
12135*	12544.0	12646.0	16135*	16755.5	16873.5	12135*	12544.5	12646.5	16135*	16756.0	16874.0	22135*	22351.5	22443.5	22135*	22351.5	22443.5	22135*	22351.5	22443.5	22135*	22351.5	22443.5	
12136*	12544.5	12646.5	16136*	16756.0	16874.0	12136*	12545.0	12647.0	16136*	16756.5	16874.5	22136*	22352.0	22444.0	22136*	22352.0	22444.0	22136*	22352.0	22444.0	22136*	22352.0	22444.0	
12137*	12545.0	12647.0	16137*	16756.5	16874.5	12137*	12545.5	12647.5	16137*	16757.0	16875.0	22137*	22352.5	22444.5	22137*	22352.5	22444.5	22137*	22352.5	22444.5	22137*	22352.5	22444.5	
12138*	12545.5	12647.5	16138*	16757.0	16875.0	12138*	12546.0	12648.0	16138*	16757.5	16875.5	22138*	22353.0	22445.0	22138*	22353.0	22445.0	22138*	22353.0	22445.0	22138*	22353.0	22445.0	
12139*	12546.0	12648.0	16139*	16757.5	16875.5	12139*	12546.5	12648.5	16139*	16758.0	16876.0	22139*	22353.5	22445.5	22139*	22353.5	22445.5	22139*	22353.5	22445.5	22139*	22353.5	22445.5	
12140*	12546.5	12648.5	16140*	16758.0	16876.0	12140*	12547.0	12649.0	16140*	16758.5	16876.5	22140*	22354.0	22446.0	22140*	22354.0	22446.0	22140*	22354.0	22446.0	22140*	22354.0	22446.0	
12141*	12547.0	12649.0	16141*	16758.5	16876.5	12141*	12547.5	12649.5	16141*	16759.0	16877.0	22141*	22354.5	22446.5	22141*	22354.5	22446.5	22141*	22354.5	22446.5	22141*	22354.5	22446.5	
12142*	12547.5	12649.5	16142*	16759.0	16877.0	12142*	12548.0	12650.0	16142*	16759.5	16877.5	22142*	22355.0	22447.0	22142*	22355.0	22447.0	22142*	22355.0	22447.0	22142*	22355.0	22447.0	
12143*	12548.0	12650.0	16143*	16759.5	16877.5	12143*	12548.5	12650.5	16143*	16760.0	16878.0	22143*	22355.5	22447.5	22143*	22355.5	22447.5	22143*	22355.5	22447.5	22143*	22355.5	22447.5	
12144*	12548.5	12650.5	16144*	16760.0	16878.0	12144*	12549.0	12651.0	16144*	16760.5	16878.5	22144*	22356.0	22448.0	22144*	22356.0	22448.0	22144*	22356.0	22448.0	22144*	22356.0	22448.0	
12145*	12549.0	12651.0	16145*	16760.5	16878.5	12145*	12549.5	12651.5	16145*	16761.0	16879.0	22145*	22356.5	22448.5	22145*	22356.5	22448.5	22145*	22356.5	22448.5	22145*	22356.5	22448.5	
12146*	12549.5	12651.5	16146*	16761.0	16879.0	12146*	12550.0	12652.0	16146*	16761.5	16879.5	22146*	22357.0	22449.0	22146*	22357.0	22449.0	22146*	22357.0	22449.0	22146*	22357.0	22449.0	
12147*	12550.0	12652.0	16147*	16761.5	16879.5	12147*	12550.5	12652.5	16147*	16762.0	16880.0	22147*	22357.5	22449.5	22147*	22357.5	22449.5	22147*	22357.5	22449.5	22147*	22357.5	22449.5	
12148*	12550.5	12652.5	16148*	16762.0	16880.0	12148*	12551.0	12653.0	16148*	16762.5	16880.5	22148*	22358.0	22450.0	22148*	22358.0	22450.0	22148*	22358.0	22450.0	22148*	22358.0	22450.0	
12149*	12551.0	12653.0	16149*	16762.5	16880.5	12149*	12551.5	12653.5	16149*	16763.0	16881.0	22149*	22358.5	22450.5	22149*	22358.5	22450.5	22149*	22358.5	22450.5	22149*	22358.5	22450.5	
12150*	12551.5	12653.5	16150*	16763.0	16881.0	12150*	12552.0	12654.0	16150*	16763.5	16881.5	22150*	22359.0	22451.0	22150*	22359.0	22451.0	22150*	22359.0	22451.0	22150*	22359.0	22451.0	
12151*	12552.0	12654.0	16151*	16763.5	16881.5	12151*	12552.5	12654.5	16151*	16764.0	16882.0	22151*	22359.5	22451.5	22151*	22359.5	22451.5	22151*	22359.5	22451.5	22151*	22359.5	22451.5	
12152*	12552.5	12654.5	16152*	16764.0	16882.0	12152*	12553.0	12655.0	16152*	16764.5	16882.5	22152*	22360.0	22452.0	22152*	22360.0	22452.0	22152*	22360.0	22452.0	22152*	22360.0	22452.0	
12153*	12553.0	12655.0	16153*	16764.5	16882.5	12153*	12553.5	12655.5	16153*	16765.0	16883.0	22153*	22360.5	22452.5	22153*	22360.5	22452.5	22153*	22360.5	22452.5	22153*	22360.5	22452.5	
12154*	12553.5	12655.5	16154*	16765.0	16883.0	12154*	12554.0	12656.0	16154*	16765.5	16883.5	22154*	22361.0	22453.0	22154*	22361.0	22453.0	22154*	22361.0	22453.0	22154*	22361.0	22453.0	
12155*	12554.0	12656.0	16155*	16765.5	16883.5	12155*	12554.5	12656.5	16155*	16766.0	16884.0	22155*	22361.5	22453.5	22155*	22361.5	22453.5	22155*	22361.5	22453.5	22155*	22361.5	22453.5	
12156*	12554.5	12656.5	16156*	16766.0	16884.0	12156*	12555.0	12657.0	16156*	16766.5	16884.5	22156*	22362.0	22454.0	22156*	22362.0	22454.0	22156*	22362.0	22454.0	22156*	22362.0	22454.0	
12157*	12555.0	12657.0	16157*	16766.5	16884.5	12157*	12555.5	12657.5	16157*	16767.0	16885.0	22157*	22362.5	22454.5	22157*	22362.5	22454.5	22157*	22362.5	22454.5	22157*	22362.5	22454.5	
12158*	12555.5	12657.5	16158*	16767.0	16885.0	12158*	12556.0	12658.0	16158*	16767.5	16885.5	22158*	22363.0	22455.0	22158*	22363.0	22455.0	22158*	22363.0	22455.0	22158*	22363.0	22455.0	
12159*	12556.0	12658.0	16159*	16767.5	16885.5	12159*	12556.5	12658.5	16159*	16768.0	16886.0	22159*	22363.5	22455.5	22159*	22363.5	22455.5	22159*	22363.5	22455.5	22159*	22363.5	22455.5	
12160*	12556.5	12658.5	16160*	16768.0	16886.0	12160*	12557.0	12659.0	16160*	16768.5	16886.5	22160*	22364.0	22456.0	22160*	22364.0	22456.0	22160*	22364.0	22456.0	22160*	22364.0	22456.0	
12161*	12557.0	12659.0	16161*	16768.5	16886.5	12161*	12557.5	12659.5	16161*	16769.0	16887.0	22161*	22364.5	22456.5	22161*	22364.5	22456.5	22161*	22364.5	22456.5	22161*	22364.5	22456.5	
12162*	12557.5	12659.5	16162*	16769.0	16887.0	12162*	12558.0	12660.0	16162*	16769.5	16887.5	22162*	22365.0	22457.0	22162*	22365.0	22457.0	22162*	22365.0	22457.0	22162*	22365.0	22457.0	
12163*	12558.0	12660.0	16163*	16769.5	16887.5	12163*	12558.5	12660.5	16163*	16770.0	16888.0	22163*	22365.5	22457.5	22163*	22365.5	22457.5	22163*	22365.5	22457.5	22163*	22365.5	22457.5	
12164*	12558.5	12660.5	16164*	16770.0	16888.0	12164*	12559.0	12661.0	16164*	16770.5	16888.5	22164*	22366.0	22458.0	22164*	22366.0	22458.0	22164*	22366.0	22458.0	22164*	22366.0	22458.0	
12165*	12559.0	12661.0	16165*	16770.5	16888.5	12165*	12559.5	12661.5	16165*	16771.0	16889.0	22165*	22366.5	22458.5	22165*	22366.5	22458.5	22165*	22366.5	22458.5	22165*	22366.5	22458.5	
12166*	12559.5	12661.5	16166*	16771.0	16889.0	12166*	12560.0	12662.0	16166*	16771.5	16889.5	22166*	22367.0	22459.0	22166*	22367.0	22459.0	22166*	22367.0	22459.0	22166*	22367.0	22459.0	
12167*	12560.0	12662.0	16167*	16771.5	16889.5	12167*	12560.5	12662.5	16167*	16772.0	16890.0	22167*	22367.5	22459.5	22167*	22367.5	22459.5	22167*	22367.5	22459.5	22167*	22367.5	22459.5	
12168*	12560.5	12662.5	16168*	16772.0	16890.0	12168*	12561.0	12663.0	16168*	16772.5	16890.5	22168*	22368.0	22460.0	22168*	22368.0	22460.0	22168*	22368.0	22460.0	22168*	22368.0	22460.0	
12169*	12561.0	12663.0	16169*	16772.5	16890.5	12169*	12561.5	12663.5	16169*	16773.0	16891.0	22169*	22368.5	22460.5	22169*	22368.5	22460.5	22169*	22368.5	22460.5	22169*	22368.5	22460.5	
12170*	12561.5	12663.5	16170*	16773.0	16891.0	12170*	12562.0	12664.0	16170*	16773.5	16891.5	22170*	22369.0	22461.0	22170*	22369.0	22461.0	22170*	22369.0	22461.0	22170*	22369.0	22461.0	
12171*	12562.0	12664.0	16171*	16773.5	16891.5	12171*	12562.5	12664.5	16171*	16774.0	16892.0	22171*	22369.5	22461.5	22171*	22369.5	22461.5	22171*	22369.5	22461.5	22171*	22369.5	22461.5	
12172*	12562.5	12664.5	16172*	16774.0	16892.0	12172*	12563.0	12665.0	16172*	16774.5	16892.5	22172*	22370.0	22462.0	22172*	22370.0	22462.0	22172*	22370.0	22462.0	22172*	22370.0	22462.0	
12173*	12563.0	12665.0	16173*	16774.5																				

ITU Telex frequency table (4/4)

\*: For WRC-7, \*\*: For WRC-12

ITU TELEX FREQUENCY TABLE (4/4)

**FURUNO**

4 MHz BAND		6 MHz BAND		8 MHz BAND		12 MHz BAND		16 MHz BAND		18/19 MHz BAND		22 MHz BAND		25/26 MHz BAND			
No.	Tx	Rx	No.	Tx	Rx	No.	Tx	Rx	No.	Tx	Rx	No.	Tx	Rx	No.	Tx	Rx
						12196**	12419.75	12419.75	16196*	16786.0	16786.0						
						12197**	12422.0	12422.0	16197*	16786.5	16786.5						
						12198**	12476.5	12476.5	16198*	16787.0	16787.0						
						12199**	12655.0	12655.0	16199*	16787.5	16787.5						
						12200**	12655.5	12655.5	16200*	16788.0	16788.0						
						12201**	12656.0	12656.0	16201*	16788.5	16788.5						
						12202**	12656.5	12656.5	16202*	16789.0	16789.0						
									16203*	16789.5	16789.5						
									16204*	16790.0	16790.0						
									16205*	16790.5	16790.5						
									16206*	16791.0	16791.0						
									16207*	16791.5	16791.5						
									16208*	16792.0	16792.0						
									16209*	16792.5	16792.5						
									16210*	16793.0	16793.0						
									16211*	16793.5	16793.5						
									16212*	16794.0	16794.0						
									16213*	16794.5	16794.5						
									16214*	16795.0	16795.0						
									16215*	16795.5	16795.5						
									16216*	16796.0	16796.0						
									16217*	16796.5	16796.5						
									16218*	16797.0	16797.0						
									16219*	16797.5	16797.5						
									16220*	16798.0	16798.0						
									16221*	16798.5	16798.5						
									16222*	16799.0	16799.0						
									16223*	16799.5	16799.5						
									16224*	16800.0	16800.0						
									16225*	16800.5	16800.5						
									16226*	16801.0	16801.0						
									16227*	16801.5	16801.5						
									16228*	16802.0	16802.0						
									16229*	16802.5	16802.5						
									16230*	16803.0	16803.0						
									16231*	16803.5	16803.5						
									16232*	16804.0	16804.0						
									16233*	16804.5	16804.5						
									16234*	16805.0	16805.0						
									16235*	16805.5	16805.5						
									16236*	16806.0	16806.0						
									16237**	16615.25	16615.25						
									16238**	16615.75	16615.75						
									16239**	16616.25	16616.25						
									16240**	16616.75	16616.75						
									16241**	16682.0	16682.0						
									16242**	16682.5	16682.5						
									16243**	16683.0	16683.0						

# APPENDIX 3 LIST OF ABBREVIATIONS

---

Control unit

## Abbreviations

Abbreviation	Term	Abbreviation	Term
ACK	Acknowledge	LV	Level
AGC	Automatic Gain Control	MAR	March
ANT	Antenna	MMSI	Maritime Mobile Services Identity number
APP	Application	MSG	Message
APR	April	NB	Noise Blanker
ATT	Attenuator	NBDP	Narrow Band Direct Printing
AUG	August	NF	Notch Filter
BRILL	Brilliance	NOV	November
COMM	Communication	NR	Noise Reduction
DEC	December	OCT	October
DSC	Digital Selective Calling	PSTN	Public Switched Telephone Networks
DUP	Duplex	PWR	Power
ENT	Enter	REF	Reference
EPFS	Electronic Position Fixing System	RF	Radio Frequency
EQUIP	Equipment	RX	Receive
FEB	February	S-DUP	Semi-Duplex
FREQ	Frequency	SEP	September
GMDSS	Global Maritime Distress and Safety System	SIMP	Simplex
INFO	Information	SP	Speaker
INTERCOM	Intercommunication System	SQ	Squelch
INTL	International	TLX	Telex
JAN	January	TRX	Transmit and Receive
JUL	July	TX	Transmit
JUN	June	UTC	Coordinated Universal Time/ Universal Time, Coordinated
LAT	Latitude	WR	Watch Receiver
LON	Longitude		



Icons

Icon	Meaning	Icon	Meaning
	Speaker ON		Noise blanker ON
	Speaker OFF		Notch filter ON
	Unread message		Number keys
	Send a distress alert of your ship.		Name of the ship registered in address book
	<ul style="list-style-type: none"> <li>Receive a distress alert from a ship in distress.</li> <li>Send a distress relay on behalf of a ship in distress.</li> </ul>		Auto ACK for individual message is ON.
	Send a general (safety, urgency or routine) message.		Data is being updated regularly.
	Receive a general (safety, urgency or routine) message.		Class of emission is SSB.
	Communicate via radiotelephone		Class of emission is TLX.
	Turn down the handset volume.		Class of emission is AM.
	Turn up the handset volume.		Class of emission is AM.
	Squelch ON	1 2 3	Class of emission is NBDP. 1: Watch 2: Scan 3: Communication
	Noise reduction: NR1 (Low), NR2 (High)		ENTER knob
	Attenuator ON		Warning Active-unacknowledged notification, icon is flashing.
	Warning Active-silenced notification, icon is flashing.		Warning Active-acknowledged, icon lights on steadily.
	Warning Active-responsibility transferred, icon lights on steadily.		Warning Rectified-unacknowledged notification, icon is flashing.
	Caution Active, icon lights on steadily.		

APPENDIX 3 LIST OF ABBREVIATIONS

Telex (NBDP)

Abbreviation	Meaning	Abbreviation	Meaning
ACK	Acknowledge	CFM	Confirm
ADV	Advise	CH	Channel
AGN	Again	COL	Collation
Alt	Alternative	Comm Mode	Communication Mode
Apr	April	Comm Status	Communication Status
ARQ	Automatic Repetition request	CRV	How do you receive?
Aug	August	Ctrl	Control
BI (GS)	Good bye	Dec	December
BK	I cut off.	DER	Out of order
Caps	Capital and Small	Dir	Direction
CFEC	Collective FEC	DSC	Digital Selective Call
DWN	Down	Over	Change-over
EEE	Error	P (or 0)	Stop your transmission.
Eng	English	PLS (PSE)	Please
Esc	Escape	PPR	Paper
Feb	February	Prt Scr	Print Screen
FEC	Forward Error Correcting	R (RCD)	Received
FM	From	RAP	I will call you again.
Fn	Function	RD	Read
Freq	Frequency	RE	Referring to
Fri	Friday	RPT	Repeat
GA	Go ahead.	Rus	Russian
HR	Here is	RX	Receiving
ID	Identification Data	Sat	Saturday
Jan	January	ScrLk	Scroll Lock
JST	Japanese Standard Time	SD	Secure Digital
Jul	July	sec	second
Jun	June	Sep	September
Mar	March	SFEC	Selective FEC
MNS	Minutes	SIO	Serial Input and Output
MOM	Wait (Waiting)	SMT	Ship's Mean Time
Mon	Monday	SRV	Sorry
msec	milli second	Sun	Sunday
MSG	Message	SVP	Please
MUTI	Mutilated	TAX	What is the charge?
NA	Correspondence to this subscriber is not admitted.	TEST MSG	Please send a test message?
NBDP	Narrow Band Direct Print	THRU	You are in communication with telex position.
NC	No circuits	Thu	Thursday
NCH	Subscriber's number has been changed.	TKS (TNX)	Thanks
NG	Non-Good	TLX	Telex
Nov	November	T.op	Timer Operation
NP	The called party is not or no longer is a subscriber.	Tue	Tuesday

(Continued on next page)

<b>Abbreviation</b>	<b>Meaning</b>	<b>Abbreviation</b>	<b>Meaning</b>
<i>(Continued from previous page)</i>			
NR	Indicate your call number.	TX	Transmission
Num	Number	USB	Universal Serial Bus
NumLk	Numerical Key Lock	UTC	Coordinated Universal Time/ Universal Time, Coordinated
OCC	Subscriber is engaged.	Ver	Version
Oct	October	Wed	Wednesday
OK	Okay	WRU	Who are you

# APPENDIX 4 DIGITAL INTERFACE (IEC 61162-1, IEC 61162-450)

---

## I/O Sentences

### ***Input sentences (IEC 61162-1, IEC 61162-450)***

ACK, ACN, GGA, GLL, GNS, HBT, RMC, ZDA

### ***Input sentence description***

- ACK - Acknowledge alert  
This sentence acknowledges an alert confirmation operation of AMS to a device.

\$--ACK,xxx\*hh<CR><LF>

1

1. Unique alert ID at alert source

- ACN - Alert command

\$\*\*ACN,hhmmss.ss,aaa,x.x,x.x,c,a\*hh<CR><LF>

1 2 3 4 5 6

1. Time
2. Manufacturer mnemonic code
3. Alert Identifier
4. Alert Instance (1 - 999999)
5. Alert command  
(A=acknowledge, Q=request/repeat information, O=responsibility transfer, S=silence)
6. Sentence status flag

- GGA - Global positioning system (GPS) fix data

\$\*\*GGA,hhmmss.ss,llll.lll,a,yyyyy.yyy,a,x,xx,x.x,x.x,M,x.x,M,x.x,xxxx\*hh<CR><LF>

1 2 3 4 5 6 7 8 9 10 11 12 13 14

1. UTC of position (000000.00 - 235959.99)
2. Latitude (0000.0000 - 9000.0000)
3. N/S
4. Longitude (00000.0000 - 18000.0000)
5. E/W
6. GPS quality indicator (1 - 7)
7. Number of satellite in use (no use)
8. Horizontal dilution of precision (no use)
9. Antenna altitude above/below mean sealevel (no use)
10. Unit, m
11. Geoidal separation (no use)
12. Unit, m
13. Age of differential GPS data (no use)
14. Differential reference station ID (no use)

- GLL - Geographic position - latitude/longitude

```
$**GLL,llll.lll,a,yyyyy.yyy,a,hhmmss.ss,a,x*hh<CR><LF>
      1 2 3 4 5 6 7
```

1. Latitude (0000.0000 - 9000.0000)
2. N/S
3. Longitude (00000.0000 - 18000.0000)
4. E/W
5. UTC of position (000000.00 - 235959.99)
6. Status (A=data valid V=data invalid)
7. Mode indicator (A=Autonomous D=Differential  
E=Estimated (dead reckoning) mode M=Manual input mode  
N=No fix S=Simulator mode)

- GNS - GNSS fix data

```
$**GNS,hhmmss.ss,llll.lll,a,lllll.lll,a,c--c,xx,x.x,x.x,x.x,x.x,x.x,x.x,a*hh<CR><LF>
      1 2 3 4 5 6 7 8 9 10 11 12 13
```

1. UTC of position (000000.00 - 235959.99)
2. Latitude (0000.0000 - 9000.0000)
3. N/S
4. Longitude (00000.0000 - 18000.0000)
5. E/W
6. Mode indicator  
N=No fix A=Autonomous D=Differential P=Precise R=Real Time Kinematic  
F=Float RTK E=Estimated Mode M=Manual Input Mode S=Simulator Mode
7. Total number of satellites in use (00 - 99)
8. HDOP (no use)
9. Antenna altitude, meters (no use)
10. Geoidal separation (no use)
11. Age of differential data (no use)
12. Differential reference station ID (no use)
13. Navigational status indicator (S=Safe C=Caution U=Unsafe V=Navigational status not valid)

- HBT - Heart beat supervision

```
$**HBT,x.x,A,x*hh<CR><LF>
      1 2 3
```

1. Configured repeat interval (1 to 999, Null)
2. Equipment status (A/V)
3. Sequential sequence identifier (0 to 9)

- RMC - Recommended minimum specific GNSS data

```
$**RMC,hhmmss.ss,A,llll.ll,a,yyyyy.yy,a,x.x,x.x,ddmmyy,x.x,a,a*hh<CR><LF>
      1 2 3 4 5 6 7 8 9 10 11 12 13
```

1. UTC of position fix (000000.00 - 235959.99)
2. Status (A=data valid, V=navigation receiver warning)
3. Latitude (0000.0000 - 9000.0000)
4. N/S
5. Longitude (00000.0000 - 18000.0000)
6. E/W
7. Speed over ground, knots (no use)
8. Course over ground, degrees true (no use)
9. Date (010100 - 311249)
10. Magnetic variation, degrees (no use)
11. E/W
12. Mode indicator (A=Autonomous D=Differential E=Estimated (dead reckoning) mode  
F=Float RTK M=Manual input mode N=No fix P=Precise R=Real time kinematic S=Simulator mode)
13. Navigational status indicator (S=Safe C=Caution U=Unsafe V=Navigational status not valid)

- ZDA - Time and date

```
$**ZDA,hhmmss.ss,xx,xx,xxxx,xx,xx*hh<CR><LF>
      1 2 3 4 5 6
```

1. UTC (000000.00 - 235959.99)
2. Day (01 - 31)
3. Month (01 -12)
4. Year (2000 - 2049)
5. Local zone, hours (no use)
6. Local zone, minutes (no use)

**Output sentences (IEC 61162-1, IEC 61162-450)**

ALC, ALF, ALR, ARC, DSC, DSE, HBT

**Output sentence description**

- ALC - Cyclic alert list

```
$**ALC,xx,xx,xx,x,x,aaa,x,x,x,x,x,"",aaa,x,x,x,x,x*hh<CR><LF>
      1 2 3 4 5 6 7 8 9
```

1. Total number of sentences this message (01 to 99)
2. Sentence number (01 to 99)
3. Sequential message identifier (00 to 99)
4. Number of alert entries
5. Manufacturer mnemonic code
6. Alert identifier Alert entry 1
7. Alert instance
8. Revision counter
9. Additional alert entries (same as 5 and 8)

- ALF - Alert sentence

```
$**ALF,x,x,x,hmmss.ss,a,a,aaa,x,x,x,x,x,x,c--c,*hh<CR><LF>
      1 2 3 4 5 6 7 8 9 10 11 12 13
```

1. Total number of ALF sentences this message (1, 2)
2. Sentence number (1, 2)
3. Sequential message identifier (0 to 9)
4. Time of last change
5. Alert category (A=Category A, B=Category B, C=Category C, NULL)
6. Alert priority (E=Emergency Alarm, A=Alarm, W=Warning, C=Caution, NULL)
7. Alert state  
(V=active - unacknowledged, S=active - silenced, A=active - acknowledged or active, O=active - responsibility transferred, U=rectified - unacknowledged, N=normal, NULL)
8. Manufacturer mnemonic code
9. Alert identifier
10. Alert instance (1 to 999999)
11. Revision counter (1 to 99)
12. Escalation counter (0 to 9)
13. Alert text

Alert ID	Category	Priority	Alert text(Where Sentence No.=1)	Alert text(Where Sentence No.=2)
620013	B	Warning	POSN NO UPD	MF/HF:Position No Update
620014	B	Warning	POSN LOST	MF/HF:Position Lost
620100	B	Warning	AC PWR FAIL	MF/HF:Ship's MAIN Failure
620210	B	Warning	RX PLL UNLOCK	MF/HF:RX PLL UNLOCK
620213	B	Warning	WR1 PLL UNLOCK	MF/HF:WR1 PLL UNLOCK
620214	B	Warning	WR2 PLL UNLOCK	MF/HF:WR2 PLL UNLOCK
620220	B	Warning	TX PLL UNLOCK	MF/HF:TX PLL UNLOCK
620340	B	Warning	MAIN AMP HEATED	MF/HF:Main AMP Heated
620341	B	Warning	VC ERROR	MF/HF:SSB:VC Error
620360	B	Warning	TUNE NG	MF/HF:Tune NG
620361	B	Warning	NATURAL TUNE	MF/HF:Natural Tune
620500	A	Warning	RX DSC DISTRESS	MF/HF:Received DSC DISTRESS
620510	A	Warning	RX DSC URGENCY	MF/HF:Received DSC URGENCY
620520	A	Warning	RX DSC SAFETY	MF/HF:Received DSC SAFETY
620530	A	Warning	RX DSC ROUTINE	MF/HF:Received DSC ROUTINE
620600	B	Warning	COM ERROR	MF/HF:Communication Error
620630	B	Warning	EPFS ERROR	MF/HF:EPFS Error
620730	B	Warning	CANNOT PRINT	MF/HF:Cannot Print
620950	B	Caution	BAM COM ERROR	MF/HF:Communication Error with BAM

- ALR - Set alarm state

This sentence acknowledges an alert condition to AMS.

\$CTALR,hhmmss,xxx,A,A,c--c\*hh<CR><LF>  
           1      2 3 4 5

1. Time of alert condition change, UTC
2. Unique alert ID at alert source
3. Alert condition (A = threshold exceeded, V = not exceeded)
4. Alert's acknowledge state (A = acknowledged, V - unacknowledged)
5. Alert's description text

Alert ID	Alert text
013	Position No Update
014	Position Lost
100	Ship's MAIN failure
210	RX PLL UNLOCK
213	WR1 PLL UNLOCK
214	WR2 PLL UNLOCK
220	TX PLL UNLOCK
340	Main AMP Heated
341	VC Error
360	Tune NG
361	Natural Tune
500	Received DSC DISTRESS
510	Received DSC URGENCY
520	Received DSC SAFETY
530	Received DSC ROUTINE
600	Communication Error
630	EPFS Error
730	Cannot Print

- ARC - Alert command refused

\$\*\*ARC,hhmmss.ss,aaa,x.x,x.x,c\*hh<CR><LF>  
           1      2 3 4 5

1. Time
2. Manufacturer mnemonic code
3. Alert identifier
4. Alert instance (1 to 999999)
5. Refused Alert Command  
 A=acknowledge, Q=request/repeat information,  
 O=responsibility transfer, S=silence

- DSC - Digital selective calling information

\$CTDSC,xx,xxxxxxxxxx,xx,xx,xx,x.x,x.x,xxxxxxxxxx,xx,a,a\*hh<CR><LF>  
           1      2      3 4 5 6 7      8      9 10 11

1. Format specifier (2 digits)
2. Address (10 digits)
3. Category (2 digits or NULL)
4. Nature of Distress or first telecommand (2 digits or NULL)
5. Type of Communication or second telecommand (2 digits)
6. Position or Channel /Frequency (Max. 4 digits)
7. Time or Tel. No. (Max. 16 digits)
8. MMSI of ship in distress (10 digits or NULL)
9. Nature of distress (2 digits or NULL)
10. Acknowledgement (R=Acknowledge request B=Acknowledgement S=Neither (end of sequence))
11. Expansion indicator (E or NULL)

- DSE - Expanded digital selective calling

\$CTDSE,x,x,a,xxxxxxxxxx,xx,c--c,.....,xx,c--c\*hh<CR><LF>  
1 2 3 4 5 6 7 8 9

1. Total number of sentences (fixed value)
2. Sentence number (fixed value)
3. Query/reply flag (fixed value A=Automatic)
4. Vessel MMSI (10 digits)
5. Data set '1' (code field, fixed value 00)
6. Data set '1' (data field, Enhanced position resolution, Max. 8 characters)
7. Additional data sets\*
8. Data set 'n' (code field)\*
9. Data set 'n' (data field)\*

\*: This equipment outputs only "Data set 1".

- HBT - Heart beat supervision

\$\*\*HBT,x.x,A,x\*hh<CR><LF>  
1 2 3

1. Configured repeat interval (1 to 999, Null)
2. Equipment status (A/V)
3. Sequential sequence identifier (0 to 9)



# APPENDIX 5 PARTS LIST

This equipment contains complex modules in which fault diagnosis and repair down to component level are not practical (IMO A.694(17)/8.3.1). Only some discrete components are used. FURUNO Electric Co., Ltd. Believes identifying these components is of no value for shipboard maintenance; therefore, they are not listed in this manual. Major modules can be located on the parts location photos on pages AP-25 thru AP-27.

## Transceiver Unit FS-1575T

<b>ELECTRICAL PARTS LIST</b>	Model	FS-1575
	Unit	Transceiver Unit FS-1575T
<b>PRINTED CIRCUIT BOARD</b>	<b>Code No.</b>	
05P0868, 150WPA	—	
05P0874, PWR	—	
05P0864A, PA-IF	—	
05P0871, P-SW	—	
05P0847A, WR1	—	
05P0847B, WR2	—	
05P0856, TX	—	
05P0842, RX	—	
05P0862B, RX-FIL	—	
05P0876, 150WTX-FIL	—	
05P0861A, T-IF	—	
05P0860, MOT	—	
05P0859, T-CPU	—	

Transceiver Unit FS-2575T

<b>ELECTRICAL PARTS LIST</b>	Model	FS-2575
	Unit	Transceiver Unit FS-2575T
<b>PRINTED CIRCUIT BOARD</b>	<b>Code No.</b>	
05P0867B, PA	—	
05P0874, PWR	—	
05P0866B, DRV	—	
05P0873, SW-REG	—	
05P0871, P-SW	—	
05P0864, PA-IF	—	
05P0847A, WR1	—	
05P0847B, WR2	—	
05P0856, TX	—	
05P0842, RX	—	
05P0862B, RX-FIL	—	
05P0870B, TX-FIL	—	
05P0861, T-IF	—	
05P0860, MOT	—	
05P0859, T-CPU	—	

Transceiver Unit FS-5075T

<b>ELECTRICAL PARTS LIST</b>	Model	FS-5075
	Unit	Transceiver Unit FS-5075T
<b>PRINTED CIRCUIT BOARD</b>	<b>Code No.</b>	
05P0866A, DRV	—	
05P0873, SW-REG	—	
05P0869, COMB	—	
05P0872, FET	—	
05P0871, P-SW	—	
05P0867A, PA	—	
05P0874, PWR	—	
05P0864, PA-IF	—	
05P0847A, WR1	—	
05P0847B, WR2	—	
05P0856, TX	—	
05P0842, RX	—	
05P0863, DUP-FIL	—	
05P0862A, RX-FIL	—	
05P0870A, TX-FIL	—	
05P0861, T-IF	—	
05P0860, MOT	—	
05P0859, T-CPU	—	

Control Unit FS-2575C

<b>ELECTRICAL PARTS LIST</b>	Model	FS-1575, FS-2575, FS-5075
	Unit	Control Unit FS-2575C
<b>PRINTED CIRCUIT BOARD</b>		<b>Code No.</b>
05P0844, PANEL		—
05P0853, C-IF		—
05P0852, C-CPU		—

Antenna Coupler AT-1575

<b>ELECTRICAL PARTS LIST</b>	Model	FS-1575
	Unit	Antenna Coupler AT-1575
<b>PRINTED CIRCUIT BOARD</b>		<b>Code No.</b>
05P0883, COUP		—

Antenna Coupler AT-5075

<b>ELECTRICAL PARTS LIST</b>	Model	FS-2575, FS--5075
	Unit	Antenna Coupler AT-5075
<b>PRINTED CIRCUIT BOARD</b>		<b>Code No.</b>
05P0875, COUP		—

Terminal Unit IB-585

<b>ELECTRICAL PARTS LIST</b>	Model	FS-1575, FS-2575, FS-5075
	Unit	Terminal Unit IB-585
<b>PRINTED CIRCUIT BOARD</b>		<b>Code No.</b>
16P0287A, TERM PWR		—
16P0283A, TERM CPU		—
16P0212, SW		—
16P0289, SD USB		—
16P0214A, PWR C		—

# APPENDIX 6 PARTS LOCATION

## Transceiver Unit FS-1575T

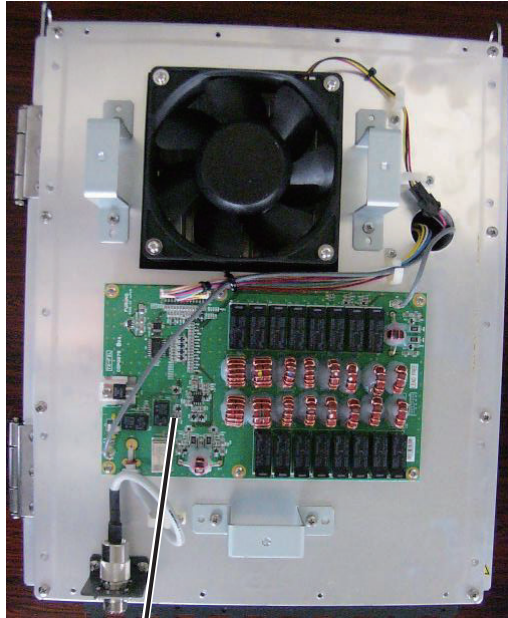

05P0876  
150WTX-FIL

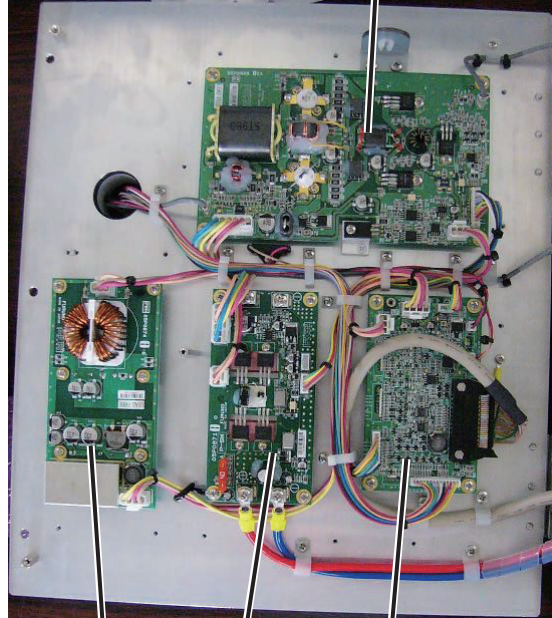

05P0868  
150WPA

05P0874 PWR  
05P0871 P-SW  
05P0864A PA-IF

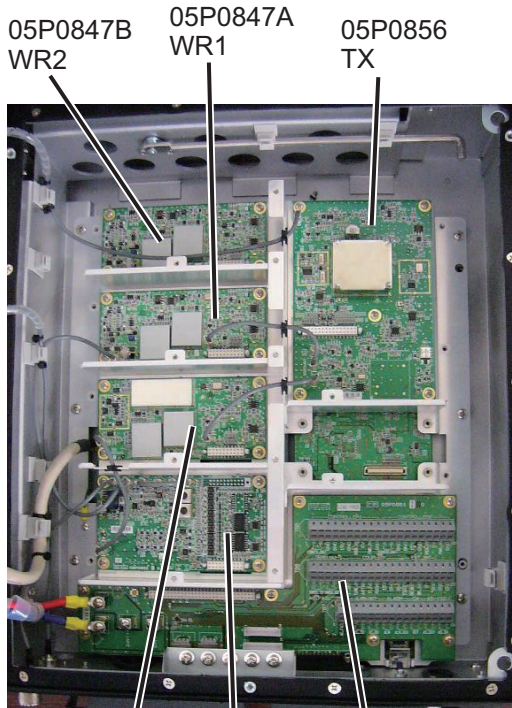

05P0847B WR2  
05P0847A WR1  
05P0856 TX

05P0842 RX  
05P0862B RX-FIL  
05P0861A T-IF

Rear side

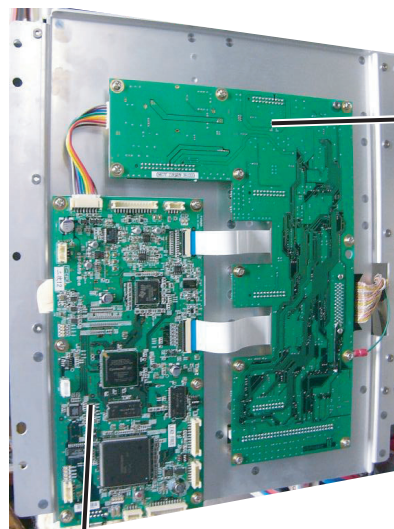

05P0860  
MOT

05P0859  
T-CPU

Transceiver Unit FS-2575T

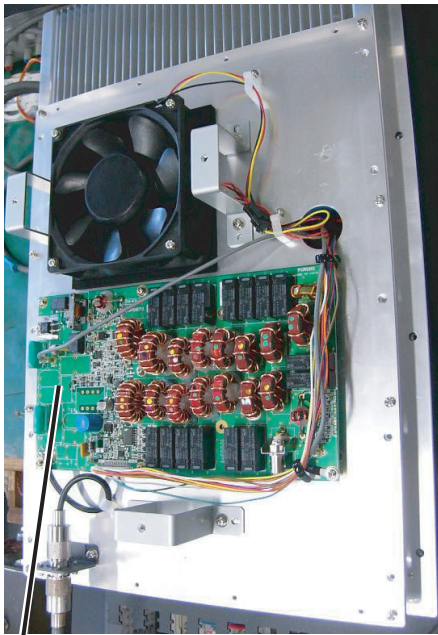

05P0870B  
TX-FIL

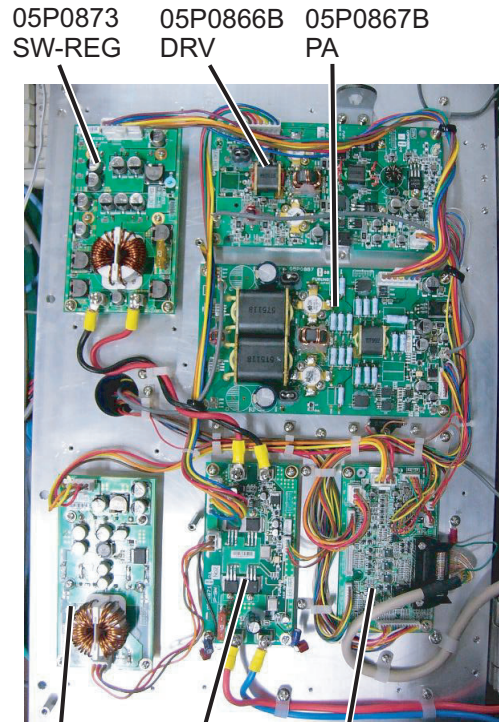

05P0873 SW-REG    05P0866B DRV    05P0867B PA

05P0874 PWR    05P0871 P-SW    05P0864 PA-IF



05P0847B WR2    05P0847A WR1    05P0856 TX

05P0842 RX    05P0862B RX-FIL    05P0861 T-IF

Rear side

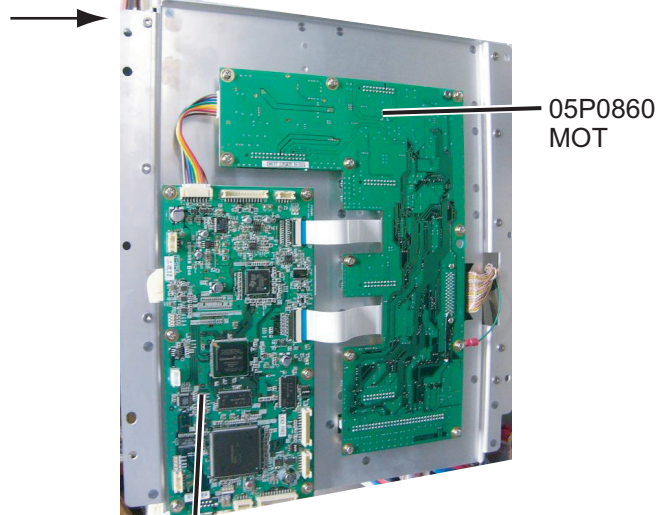

05P0860  
MOT

05P0859  
T-CPU

Transceiver Unit FS-5075T

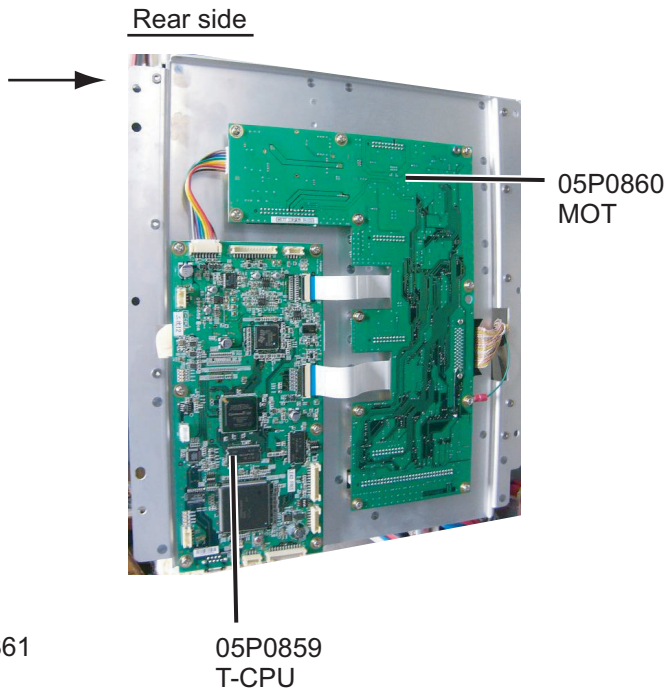
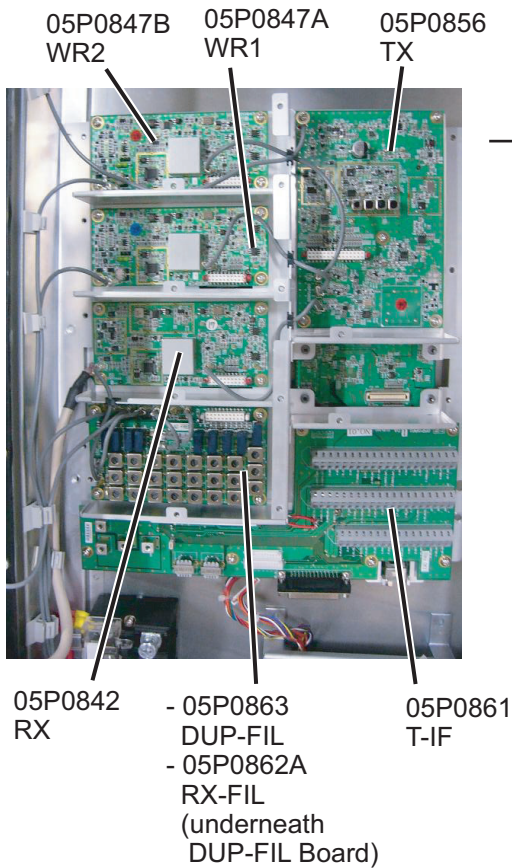
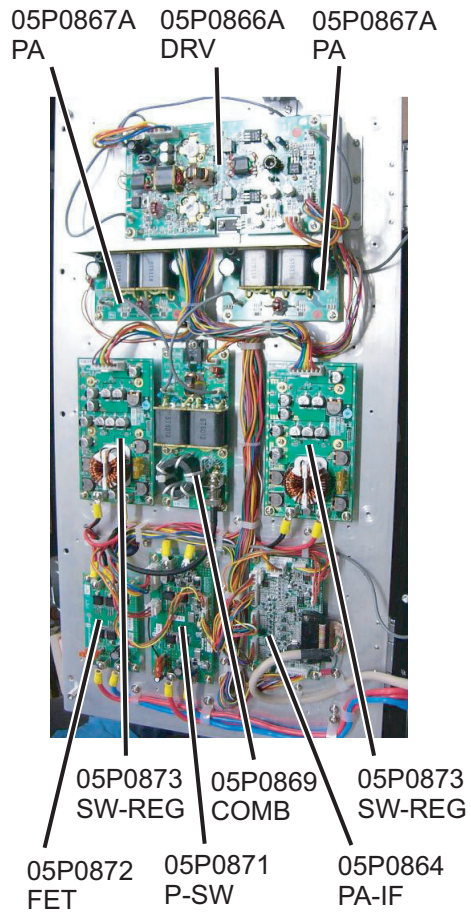
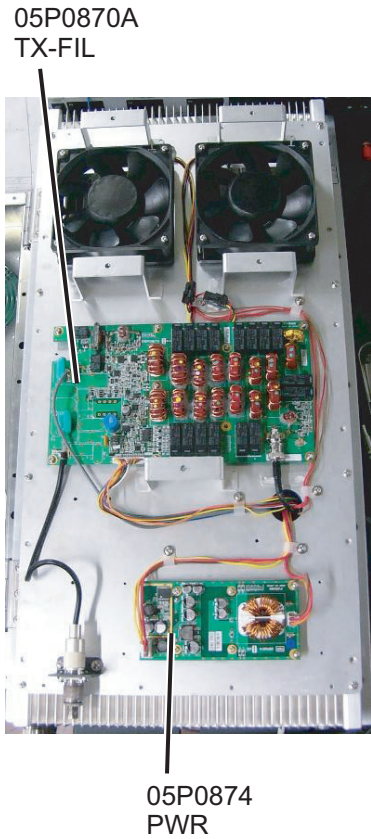

Control Unit FS-2575C

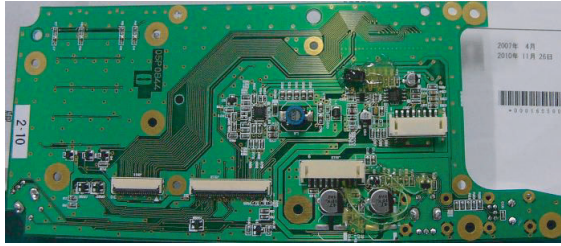

05P0844 (PANEL)

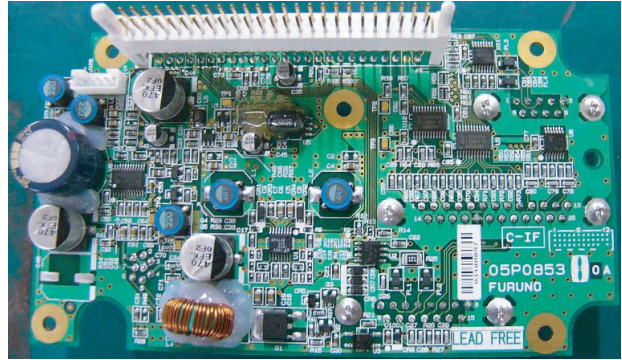

05P0853 (C-IF)

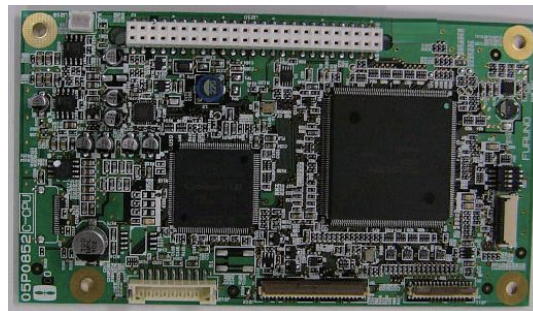

05P0852 (C-CPU)

Antenna Copuler AT-1575

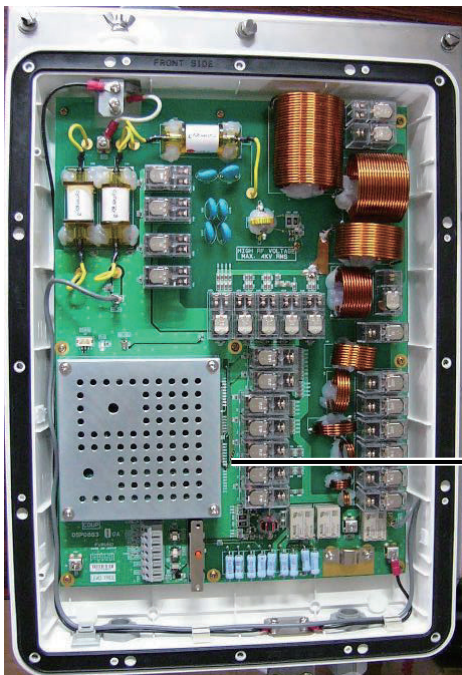

05P0883  
COUP

Antenna Copuler AT-5075

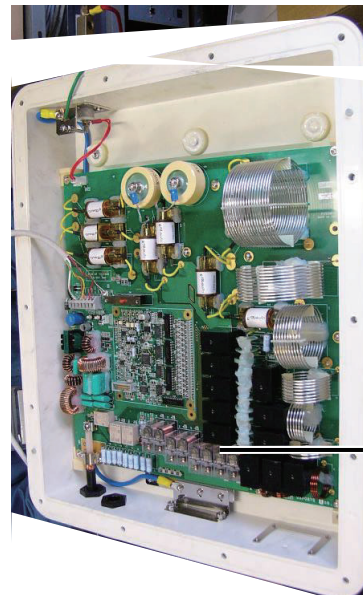

05P0875  
COUP

Terminal Unit IB-585

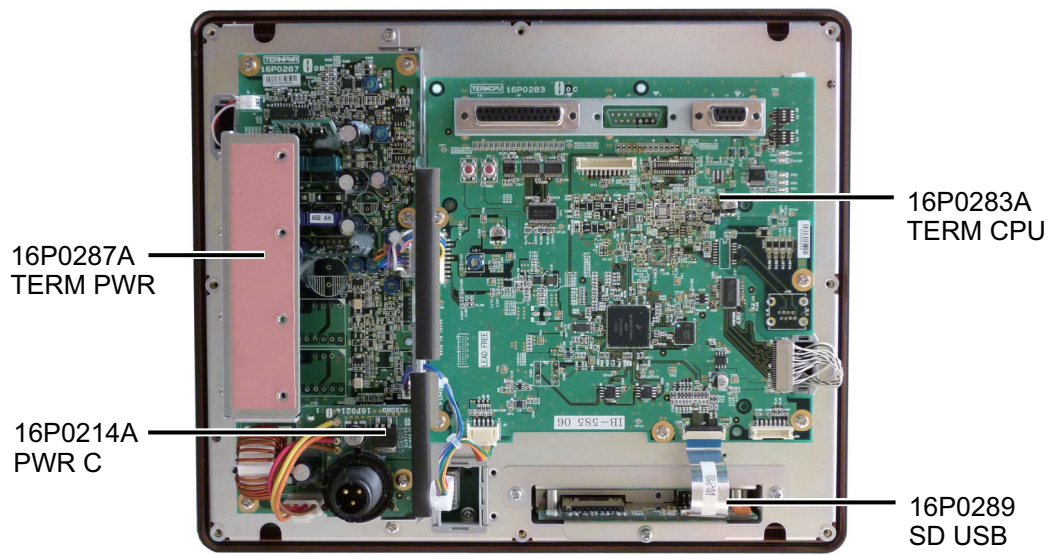



# APPENDIX 7 ALERT LIST AND CODES

The table below shows the alert ID, message, priority, category, meaning and remedy for each alert.

Alert ID	Pop-up message	Priority/ Category	Meaning/Remedy
013 (620013)	Position data is not updated! Position was older than 4H. Update it. [CANCEL]: Stop alarm	Warning/ B	Position data has not been updated for 4 hours. Ensure that EPFS is on and connected securely. Entering position data manually will also remove the message (see section 6.7).
014 (620014)	Lost position! Position was older than 23.5H. You must update position! [CANCEL]: Stop alarm	Warning/ B	Position data was deleted because data had not been updated for 23.5 hours. Ensure that EPFS is on and connected securely. Entering position data manually will also remove the message (see section 6.7).
100 (620100)	TX power reduced. Ship's main failure. [CANCEL]: Stop alarm	Warning/ B	AC power has been turned off. System power is currently supplied by backup battery. RF output power is reduced. Check AC power.
210 (620210)	RX PLL UNLOCK [CANCEL]: Stop alarm	Warning/ B	No signal can be received due to unlocked RX circuit PLL. Try to use another channel. If this alert occurs frequently, contact your dealer.
213 (620213)	WR1 PLL UNLOCK [CANCEL]: Stop alarm	Warning/ B	DSC distress and urgency signals cannot be received due to unlocked WR1 circuit PLL. Contact your dealer.
214 (620214)	WR2 PLL UNLOCK [CANCEL]: Stop alarm	Warning/ B	DSC individual and safety signals cannot be received due to unlocked WR2 circuit PLL. Contact your dealer.
220 (620220)	TX PLL UNLOCK [CANCEL]: Stop alarm	Warning/ B	No signal can be transmitted due to unlocked TX circuit PLL. Try to use another channel. If this alert occurs frequently, contact your dealer.
340 (620340)	TX power reduced. Main AMP heated. [CANCEL]: Stop alarm	Warning/ B	RF output power was reduced due to overheating power amplifier. Allow the transceiver unit to cool. If the problem persists, contact your dealer.
341 (620341)	VC error! Please restart the power supply. [CANCEL]: Stop alarm	Warning/ B	Transmitter does not work due to abnormal voltage in power amplifier circuit. Turn off the power and turn it on again.
360 (620360)	TUNE NG [CANCEL]: Stop alarm	Warning/ B	System failed to match the impedance of antenna to transmission line. Check connections on antenna coupler and antenna system, and then re-tune antenna.
361 (620361)	TX power reduced. Natural tune [CANCEL]: Stop alarm	Warning/ B	Output power was reduced due to over-current in antenna. Check antenna system and re-tune antenna.
(620500)	Received DSC DISTRESS [CANCEL]: Stop alarm	Warning/ A	DSC distress message is received. Check the message.

Alert ID	Pop-up message	Priority/Category	Meaning/Remedy
(620510)	Received DSC URGENCY [CANCEL]: Stop alarm	Warning/ A	DSC urgency message is received. Check the message.
(620520)	Received DSC SAFETY [CANCEL]: Stop alarm	Warning/ A	DSC safety message is received. Check the message.
(620530)	Received DSC ROUTINE [CANCEL]: Stop alarm	Warning/ A	DSC routine message is received. Check the message.
600 (620600)	Communication Error [CANCEL]: Stop alarm	Warning/ B	Transceiver unit cannot communicate with control unit. Check connection between transceiver unit and control unit. If the problem persists, contact your dealer.
630 (620630)	EPFS error! Please update your position data automatically or manually. [CANCEL]: Stop alarm	Warning/ B	No data from EPFS. Ensure that EPFS is on and connected securely. Entering position data manually will also remove the message (see section 6.7).
730 (620730)	Cannot print. Check printer. [CANCEL]: Stop alarm	Warning/ B	Printer can not print. Ensure that paper is loaded and cables are firmly connected.
(620950)	Communication error with BAM! [CANCEL]: Close window	Caution	HBT sentence from BAM was cut off. Check connection to BAM, check power to BAM.

**Note 1:** If you are in a mode which is using BAMS (Bridge Alert Management System), the alert ID (six digits in parentheses) will be displayed.

**Note 2:** Alert ID 620950 will only be output when BAMS mode is active. The alert icon for 620950 is  .

**SPECIFICATIONS OF SSB RADIOTELEPHONE  
FS-1575/2575/5075**

**1 MF/HF DIGITAL RADIOTELEPHONE**

**1.1 GENERAL**

- 1.1.1 Communication system
  - FS-1575/2575 Semi-duplex or simplex
  - FS-5075 Full-duplex (option required), semi-duplex or simplex
- 1.1.2 Class of emission
  - J3E: Telephone
  - F1B (J2B): DSC and NBDP
  - H3E: reception only
  - A1A, F3C: requires settings for communications
- 1.1.3 Number of channel
  - User programmable: 256 TX/RX pairs
  - All ITU channels incorporated (include DSC/NBDP), SSB, TLX, CW
- 1.1.4 Warming up
  - 1 minute approx. (oven 15 minutes approx.)

**1.2 TRANSMITTER**

- 1.2.1 Frequency range
  - 1,605 kHz to 27.5 MHz (100 Hz step)
- 1.2.2 RF output power
  - FS-1575 MF/HF: 150 Wpep
  - FS-2575 MF/HF: 250 Wpep
  - FS-5075 MF: 400 Wpep, HF: 500 Wpep
- 1.2.3 Frequency stability
  - ±10 Hz
- 1.2.4 MIC in sensitivity
  - 1 kHz, 94 dBA maximum power: -9 dB to -3 dB
- 1.2.5 Line in sensitivity
  - 1 kHz, -16 dBm maximum power: -9 dB to -3 dB
- 1.2.6 Audio frequency range
  - 350 Hz to 2.7 kHz (within 6dB)

**1.3 RECEIVER**

- 1.3.1 Receiving system
  - Double-conversion superheterodyne
- 1.3.2 Frequency range
  - 100 kHz-29,999.99 kHz (10 Hz step)
- 1.3.3 Sensitivity (SINAD 20 dB)

Frequency Range	J3E
100 kHz to 300 kHz	35 dBμV
300 kHz to 1.6 MHz	25 dBμV
1.6 MHz to 4.0 MHz	13 dBμV
4.0 MHz to 30 MHz	7 dBμV

- 1.3.4 Intermediate frequency
  - 1st: 53.964 MHz, 2nd: 36 kHz
- 1.3.5 Spurious response
  - Better than 60 dB
- 1.3.6 Audio output power
  - Speaker: 3 W/4 ohm
  - Handset: 10 mW/150 ohm
  - Line output: 0 dBm/600 ohm
- 1.3.7 Standard features
  - AGC, Noise blanker, Voice-activated squelch, Noise reduction, Notch filter, Attenuator

**2 DSC/WATCH KEEPING RECEIVER****2.1 DIGITAL SELECTIVE CALLING**

- |       |                 |  |
|-------|-----------------|--|
| 2.1.1 | Frequency shift | Mark: F-85Hz, Space: F+85 Hz (F: assigned frequency) |
| 2.1.2 | Baud rate       | 100 bps $\pm$ 30 x 10 <sup>-6</sup>                  |
| 2.1.3 | Protocol        | ITU-R Rec.493-14, 541-10                             |
| 2.1.4 | Modulation      | FSK  |

**2.2 DSC/WATCH RECEIVER (DISTRESS)**

- |       |                         |  |
|-------|-------------------------|--|
| 2.2.1 | Frequency range         | 2187.5/ 4207.5/ 6312.0/ 8414.5/ 12577.0/ 16804.5 kHz |
| 2.2.2 | Class of emission       | F1B (J2B)  |
| 2.2.3 | Antenna impedance       | 50 ohm   |
| 2.2.4 | Sensitivity             | 0 dB $\mu$ V or less                                 |
| 2.2.5 | Intermediate frequency  | 1st: 35.964 MHz, 2nd: 36 kHz                         |
| 2.2.6 | Frequency stability     | $\pm$ 10 Hz  |
| 2.2.7 | Output power for preamp | 12 VDC: 0.15 A max.                                  |
| 2.2.8 | Spurious response       | Better than 60 dB                                    |

**2.3 DSC/WATCH RECEIVER (GENERAL FREQUENCY, OPTION)**

- |       |                         |                              |
|-------|-------------------------|------------------------------|
| 2.3.1 | Frequency range         | 1605 kHz to 27.5 MHz         |
| 2.3.2 | Class of emission       | F1B (J2B)                    |
| 2.3.3 | Antenna impedance       | 50 ohm                       |
| 2.3.4 | Sensitivity             | 0 dB $\mu$ V or less         |
| 2.3.5 | Intermediate frequency  | 1st: 44.964 MHz, 2nd: 36 kHz |
| 2.3.6 | Output power for preamp | 12 VDC: 0.15 A max.          |
| 2.3.7 | Spurious response       | Better than 60 dB            |

**3 NBDP FUNCTION (OPTION)**

- |     |                    |  |
|-----|--------------------|--|
| 3.1 | Communication mode | ARQ, FEC                                   |
| 3.2 | Protocol           | ITU-R M625-3, M476-5, M490, M491-1, M492-6 |
| 3.3 | Modulation         | FSK  |

**4 CONTROL UNIT**

- |     |                  |                                      |
|-----|------------------|--------------------------------------|
| 4.1 | Display system   | 4.3-inch color dot matrix            |
| 4.2 | Pixel            | 480 x 272 dots                       |
| 4.3 | Brilliance       | 18 steps (off to maximum brightness) |
| 4.4 | Built-in speaker | 4 ohms                               |
| 4.5 | Alarm volume     | 80 to 85 dB(A)                       |
| 4.6 | Visible distance | 0.7 m nominal                        |

## 5 ANTENNA COUPLER

- 5.1 Tuning system CPU controlled fully automatic tuning system
- 5.2 Frequency range 1605 kHz to 27.5 MHz
- 5.3 Input impedance 50 ohm
- 5.4 Antenna 10 m to 18 m wire or 10 m whip, or  
8 m whip + horizontal feeder 2 m or more
- 5.5 Tuning time Within 15 seconds

## 6 TERMINAL UNIT (OPTION)

- 6.1 Display 10.4" color TFT LCD, 800 x 600 dots (SVGA)
- 6.2 Brilliance 11 steps
- 6.3 External memory SD card: 2 GB max. or SDHC card: 32 GB max.  
(SDHC card: formatted and recognized as a 2GB card)
- 6.4 Keyboard interface USB2.0, 1.5Mbps
- 6.5 Visible distance 0.7 m nominal

## 7 INTERFACE

- 7.1 Serial data
  - Format IEC 61162-1 Ed.4 (2010-11)
  - Sentences
    - Input ACK, ACN, GGA, GLL, GNS, HBT, RMC, ZDA
    - Output ALC, ALF, ALR, ARC, DSC, DSE, HBT
- 7.2 LAN
  - Physical format Ethernet 10Base-T/100Base-TX, RJ45 connector
  - Data format IEC61162-450
  - Transmission group
    - Input MISC (TGTD, NAVD, PROP)
    - Output Arbitrary (default: RCOM)
  - Sentences
    - Input ACK, ACN, HBT (GGA, GLL, GNS, RMC, ZDA)
    - Output ALF, ALC, ALR, ARC, HBT
  - Other network function Ping, SNMP, Syslog, FURUNO Management Protocol

## 8 POWER SUPPLY

- 8.1 Transceiver/control unit
  - FS-1575 24 VDC: 5A (RX), 20 A max. (TX)
  - FS-2575 24 VDC: 5A (RX), 40 A max. (TX)
  - FS-5075 24 VDC: 5A (RX), 60 A max. (TX)
  - Emergency battery use (TX): 15A (FS-1575), 22A (FS-2575), 30A (FS-5075) max.
- 8.2 Terminal unit (option) 12-24 VDC: 0.5-0.3 A
- 8.3 Printer (PP-520, option) 24 VDC: 1 A
- 8.4 AC/DC power supply unit
  - PR-300 (for FS-1575, option) 100/110/200/220VAC, 1 phase, 50/60 Hz
  - PR-850A (for FS-2575/5075, option) 100/110/120/200/220/240VAC, 1 phase, 50/60 Hz

**9 ENVIRONMENTAL CONDITION**

- 9.1 Ambient temperature
  - Antenna coupler -25°C to +55°C
  - Indoor units -15°C to +55°C
- 9.2 Relative humidity 93% or less at 40°C
- 9.3 Degree of protection
  - Antenna coupler IP56
  - Transceiver unit IP22 (bulkhead mount only)
  - Terminal unit IP20 (IP22: option required)
  - Control unit IP20 (IP22: option required)
- 9.4 Vibration IEC60945 Ed.4

**10 COATING COLOR**

- 10.1 Antenna coupler N9.5 (white)
- 10.2 Transceiver/control unit N3.0

# INDEX

---

## A

- Abbreviation .....AP-16
- Address book
  - deleting.....6-16
  - editing.....6-15
  - list.....6-14
  - registration .....6-15
- Alarm lists .....6-26
- Aler list and codes.....AP-33
- Antenna selection .....6-12
- Area message
  - receiving.....5-14
  - sending.....5-12
- Attenuator .....2-6
- Audio alarms .....3-3
- Auto ACK setting.....6-22

## B

- Brilliance .....1-5

## C

- Channel setting .....2-2
- Clarifier setting .....6-13
- Class of emission .....2-1
- Control description .....1-1

## D

- Daily test .....11-1
- Date and time setting .....6-9
- Digital interface .....AP-20
- Distress alert
  - canceling .....4-16
  - receiving.....4-6
  - sending.....4-1
- Distress relay
  - receiving.....4-15
  - sending.....4-11
- DSC frequency setting .....5-3
- DSC message .....3-1
- DSC scan screen .....1-4

## E

- Error message .....11-4
- External alarm setting .....6-13

## F

- FAX setting .....6-12
- Frequency setting .....2-2
- Frequency table .....AP-3

## G

- Group message
  - receiving.....5-11
  - sending.....5-10
- Group message preparation .....6-19

## I

- Icon .....AP-17
- Individual message
  - receiving.....5-7
  - sending.....5-2
- Individual message preparation .....6-18
- Intercom .....1-7

## K

- Key assignment .....6-7

## L

- Log file
  - deleting.....6-6
  - opening .....6-5

## M

- Maintenance .....11-3
- Medical message
  - receiving.....5-18
  - sending.....5-17
- MENU screen open/close .....6-1
- Menu tree .....AP-1

## N

- NBDP .....7-1
  - abbreviation.....AP-18
  - answerback code registration .....8-1
  - ARQ mode .....10-3
  - automatic telex.....10-15
  - creating file.....9-1
  - deleting file .....9-8
  - Edit menu .....7-6
  - editing file .....9-3
  - enamling file.....9-7
  - FEC mode .....10-5
  - File menu .....7-6
  - ID code registration .....8-2
  - macrofile.....10-10
  - maintenance.....11-6
  - menu tree .....AP-2
  - Operate menu .....7-7
  - printing file .....9-8
  - reception mode .....10-5
  - saving file .....9-2
  - saving file under new name .....9-8
  - scan channel group.....8-6
  - scanning.....10-9
  - station list .....8-2
  - Station menu .....7-8
  - System menu .....7-8
  - timer operation .....10-8
  - timer programming .....8-4
  - Window menu .....7-7
- Network setting .....6-14
- Neutral message

## INDEX

receiving.....	5-16
sending.....	5-14
Noise blanker .....	2-5
Noise reduction .....	2-5
Notch filter .....	2-6

### **P**

Parst list .....	AP-25
Parst location .....	AP-28
Polling request message.....	5-19
Position message	
receiving .....	5-22
sending.....	5-20
Position setting.....	6-8
Power on/off.....	1-3
Printing message .....	6-8
Priority .....	1-6
PSTN message	
receiving .....	5-26
sending.....	5-24
PSTN message preparation.....	6-20

### **R**

RF gain .....	2-5
RT screen .....	1-3

### **S**

Scanning frequency .....	1-5, 6-23
Session .....	1-7
S-meter .....	2-5
Sound setting .....	6-25
Speaker.....	1-5
Special message.....	6-23
Squelch .....	2-6
Squelch frequency .....	6-7

### **T**

Test call.....	11-5
Test message preparation .....	6-20
Timeout setting .....	6-10
Tone test .....	11-2
Transmission power.....	2-3
Troubleshooting .....	11-4
TX self test .....	11-2

### **U**

User channel	
deleting.....	6-4
editing.....	6-3
list.....	6-2
registration .....	6-2

### **W**

Working channel setting.....	5-4
Working frequency setting .....	5-4



## Declaration of Conformity



# 0560

We **FURUNO ELECTRIC CO., LTD.**

(Manufacturer)

9-52 Ashihara-Cho, Nishinomiya City, 662-8580, Hyogo, Japan

(Address)

declare under our sole responsibility that the product

**SSB RADIOTELEPHONE FS-1575**

(Model name, type number)

to which this declaration relates conforms to the following standard(s) or normative document(s)

IMO Resolution A.694(17)	EN 300 338-1 V1.3.1: 2010
IMO Resolution A.806(19)	EN 300 338-2 V1.3.1: 2010
IMO Resolution MSC.36(63)	EN 300 373-1 V1.4.1: 2013
IMO Resolution MSC.68(68)/A3	EN 301 033 V1.4.1: 2013
IMO Resolution MSC/Circ.862	EN 301 843-5 V1.1.1: 2004
IMO Resolution MSC.1/Circ.1460	ETS 300 067: 1990
IEC 60945 Ed.4.0: 2002 incl.Corr.1:2008	ETS 300 067 A1: 1993
IEC 61162-1 Ed.4.0: 2010	
IEC 61162-450 Ed.1.0: 2011	
IEC 62288 Ed.1.0: 2008	
ITU-R M.1082-1, M.1173-1, M.476-5, M491-1, M.492-6, M.493-14, M.541-10, M.625-4	

(title and/or number and date of issue of the standard(s) or other normative document(s))

For assessment, see

- EC type-examination (Module B) certificate No. 172120123 issued by Telefication, The Netherlands.
- Product Quality System (Module D) certificate No. P 112 issued by Telefication, The Netherlands.

This declaration is issued according to the Directive 2014/90/EU of the European Parliament and of the Council on marine equipment, and the Implementing Regulation (EU) 2017/306.

On behalf of Furuno Electric Co., Ltd.

Nishinomiya City, Japan  
May 10, 2017

(Place and date of issue)

Yoshitaka Shogaki  
Department General Manager  
Quality Assurance Department

(name and signature or equivalent marking of authorized person)

## Declaration of Conformity

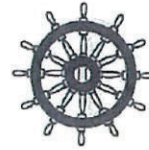

# 0560

We **FURUNO ELECTRIC CO., LTD.**

(Manufacturer)

9-52 Ashihara-Cho, Nishinomiya City, 662-8580, Hyogo, Japan

(Address)

declare under our sole responsibility that the product

**SSB RADIOTELEPHONE FS-2575**

(Model name, type number)

to which this declaration relates conforms to the following standard(s) or normative document(s)

IMO Resolution A.694(17)	EN 300 338-1 V1.3.1: 2010
IMO Resolution A.806(19)	EN 300 338-2 V1.3.1: 2010
IMO Resolution MSC.36(63)	EN 300 373-1 V1.4.1: 2013
IMO Resolution MSC.68(68)/A3	EN 301 033 V1.4.1: 2013
IMO Resolution MSC/Circ.862	EN 301 843-5 V1.1.1: 2004
IMO Resolution MSC.1/Circ.1460	ETS 300 067: 1990
IEC 60945 Ed.4.0: 2002 incl.Corr.1:2008	ETS 300 067 A1: 1993
IEC 61162-1 Ed.4.0: 2010	
IEC 61162-450 Ed.1.0: 2011	
IEC 62288 Ed.1.0: 2008	
ITU-R M.1082-1, M.1173-1, M.476-5, M491-1, M.492-6, M.493-14, M.541-10, M.625-4	

(title and/or number and date of issue of the standard(s) or other normative document(s))

For assessment, see

- EC type-examination (Module B) certificate No. 162120004 issued by Telefication, The Netherlands.
- Product Quality System (Module D) certificate No. P 112 issued by Telefication, The Netherlands.

This declaration is issued according to the Directive 2014/90/EU of the European Parliament and of the Council on marine equipment, and the Implementing Regulation (EU) 2017/306.

On behalf of Furuno Electric Co., Ltd.

Nishinomiya City, Japan  
May 16, 2017

(Place and date of issue)

Yoshitaka Shogaki  
Department General Manager  
Quality Assurance Department

(name and signature or equivalent marking of authorized person)

## Declaration of Conformity



# 0560

We **FURUNO ELECTRIC CO., LTD.**

(Manufacturer)

9-52 Ashihara-Cho, Nishinomiya City, 662-8580, Hyogo, Japan

(Address)

declare under our sole responsibility that the product

**SSB RADIOTELEPHONE FS-5075**

(Model name, type number)

to which this declaration relates conforms to the following standard(s) or normative document(s)

IMO Resolution A.694(17)	EN 300 338-1 V1.3.1: 2010
IMO Resolution A.806(19)	EN 300 338-2 V1.3.1: 2010
IMO Resolution MSC.36(63)	EN 300 373-1 V1.4.1: 2013
IMO Resolution MSC.68(68)/A3	EN 301 033 V1.4.1: 2013
IMO Resolution MSC/Circ.862	EN 301 843-5 V1.1.1: 2004
IMO Resolution MSC.1/Circ.1460	ETS 300 067: 1990
IEC 60945 Ed.4.0: 2002 incl.Corr.1:2008	ETS 300 067 A1: 1993
IEC 61162-1 Ed.4.0: 2010	
IEC 61162-450 Ed.1.0: 2011	
IEC 62288 Ed.1.0: 2008	
ITU-R M.1082-1, M.1173-1, M.476-5, M491-1, M.492-6, M.493-14, M.541-10, M.625-4	

(title and/or number and date of issue of the standard(s) or other normative document(s))

For assessment, see

- EC type-examination (Module B) certificate No. 162120005 issued by Telefication, The Netherlands.
- Product Quality System (Module D) certificate No. P 112 issued by Telefication, The Netherlands.

This declaration is issued according to the Directive 2014/90/EU of the European Parliament and of the Council on marine equipment, and the Implementing Regulation (EU) 2017/306.

On behalf of Furuno Electric Co., Ltd.

Nishinomiya City, Japan  
May 17, 2017

(Place and date of issue)

Yoshitaka Shogaki  
Department General Manager  
Quality Assurance Department

(name and signature or equivalent marking of authorized person)