

# *Installation Manual*

## **MULTI FUNCTION DISPLAY**

### *Model TZT16X/TZT22X/TZT24X*

---

<b>SAFETY INSTRUCTIONS</b> .....	<b>i</b>
<b>SYSTEM CONFIGURATION</b> .....	<b>iii</b>
<b>EQUIPMENT LISTS</b> .....	<b>v</b>
<b>1. MOUNTING</b> .....	<b>1-1</b>
1.1 Installation of Multi Function Display.....	1-1
1.2 Flush Mounting .....	1-2
1.3 Desktop Mounting (TZT16X only, option) .....	1-5
1.4 Installation of Transducers (TZT16X only).....	1-6
<b>2. WIRING</b> .....	<b>2-1</b>
2.1 Interface Connections (rear of the unit) .....	2-1
2.2 Power Cable .....	2-3
2.3 Grounding Wire (16X only) .....	2-3
2.4 MULTI Cable.....	2-3
2.5 DRS Radar Sensor Connections .....	2-4
2.6 Network Connection with Other TZT Series Units .....	2-4
2.7 NMEA 2000 Connector .....	2-4
2.8 Example TZT16X/22X/24X System Configuration.....	2-9
<b>3. HOW TO SET UP THE EQUIPMENT</b> .....	<b>3-1</b>
3.1 How to Set Time Zone, Time Format and Language.....	3-3
3.2 How to Set Units of Measurement .....	3-4
3.3 Initial Setup .....	3-5
3.4 How to Set Up the Radar (For the service technician only).....	3-11
3.5 How to Set Up the Fish Finder.....	3-13
3.6 Wireless LAN Setting .....	3-19
3.7 Ferry Mode.....	3-20
3.8 How to Manage Your Charts.....	3-20
3.9 IP Camera Setup .....	3-25
<b>APPX. 1 TRANSDUCER INSTALLATION GUIDE</b> .....	<b>AP-1</b>
<b>APPX. 2 TRANSDUCER LIST</b> .....	<b>AP-12</b>
<b>PACKING LIST(S)</b> .....	<b>A-1</b>
<b>OUTLINE DRAWING(S)</b> .....	<b>D-1</b>
<b>INTERCONNECTION DIAGRAM(S)</b> .....	<b>S-1</b>

**FURUNO ELECTRIC CO., LTD.**[www.furuno.com](http://www.furuno.com)

All brand and product names are trademarks, registered trademarks or service marks of their respective holders.

**FURUNO ELECTRIC CO., LTD.**

9-52 Ashihara-cho,  
Nishinomiya, 662-8580, JAPAN

• FURUNO Authorized Distributor/Dealer

All rights reserved. Printed in Japan

Pub. No. IME-45240-D

(TEHI ) TZT24X/TZT22X/TZT16X

A : AUG. 2023

D : AUG. 05, 2024



0 0 0 2 0 0 1 4 3 1 3



# SAFETY INSTRUCTIONS



## WARNING

Indicates a potentially hazardous situation which, if not avoided, could result in death or serious injury.



## CAUTION

Indicates a potentially hazardous situation which, if not avoided, may result in minor or moderate injury.

(Examples of symbols)



Warning, Caution



Prohibitive Action



Mandatory Action



## WARNING



**ELECTRICAL SHOCK HAZARD**  
Do not open the equipment unless totally familiar with electrical circuits.

Only qualified personnel should work inside the equipment.



**Turn off the power at the switchboard before beginning the installation.**

Fire or electrical shock can result if the power is left on.



**Be sure that the power supply is compatible with the voltage rating of the equipment.**

Connection of an incorrect power supply can cause fire or damage the equipment.



**If your vessel is configured with an autopilot system, install an autopilot control unit (or emergency autopilot stop button) at each helm station, to allow you to disable the autopilot in an emergency.**

If the autopilot cannot be disabled, accidents may result.



## CAUTION



Ground the equipment to prevent electrical shock and mutual interference.



**Use the proper fuse.**

Use of an incorrect fuse may damage the equipment.



**The front panel is made of glass. Handle it with care.**

Injury can result if the glass breaks.



Observe the following compass safe distances to prevent interference to a magnetic compass:

Model	Standard compass	Steering compass
TZT16X	0.95 m	0.60 m
TZT22X	1.15 m	0.75 m
TZT24X	0.95 m	0.60 m
HUB-101	0.80 m	0.50 m

## **WARNING**



**The radar antenna sends electromagnetic radio frequency (RF) energy. This energy can be dangerous to you, especially your eyes. Do not look at the radiator or near the antenna when the antenna is rotating.**

The distances at which RF radiation levels of 100 W/m<sup>2</sup> and 10 W/m<sup>2</sup> exist are shown in the table.

Antenna Model	Distance to 100 W/m <sup>2</sup> point	Distance to 10 W/m <sup>2</sup> point	Antenna Model	Distance to 100 W/m <sup>2</sup> point	Distance to 10 W/m <sup>2</sup> point
DRS4D-NXT	N/A	0.7	DRS6A-NXT (XN10A)	N/A	0.6
DRS4D-NXT	N/A	0.7	DRS6A-NXT (XN12A)	N/A	0.6
DRS4DL+	N/A	0.9	DRS6A-NXT (XN13A)	N/A	0.4
DRS6A X-Class (XN12A)	N/A	2.2	DRS12A-NXT (XN12A)	0.2	1.9
DRS6A X-Class (XN13A)	N/A	1.9	DRS12A-NXT (XN13A)	0.15	1.8
DRS12A X-Class (XN12A)	0.3	3.1	DRS25A-NXT (XN12A)	0.3	2.8
DRS12A X-Class (XN13A)	0.2	2.9	DRS25A-NXT (XN13A)	0.2	2.65
DRS25A X-Class (XN12A)	0.8	7.7	DRS4D X-Class	0.53	1.7
DRS25A X-Class (XN13A)	0.7	6.8			



**Check that no person is near the open-type radar antenna before you turn on the radar.**

Serious injury or death can occur if a person is hit by a rotating radar antenna.

### **About the TFT LCD**

The TFT LCD is constructed using the latest LCD techniques, and displays 99.99% of its pixels. The remaining 0.01% of the pixels may drop out or blink, however this is not an indication of malfunction.



# SYSTEM CONFIGURATION

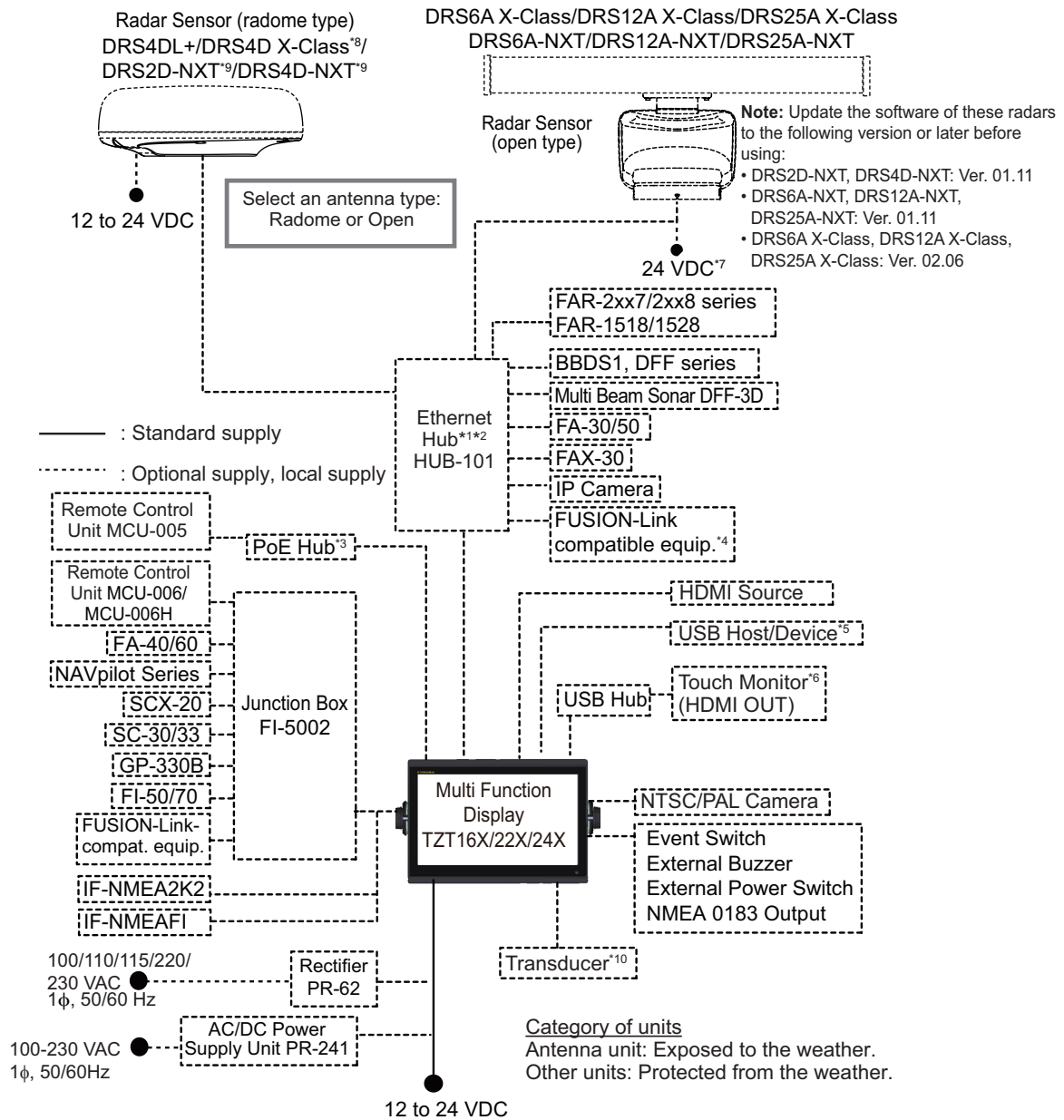

\*1: A maximum of 3 units of HUB-101 can be connected.

\*2: With the Ethernet HUB, up to six NavNet TZtouch series units can be connected (up to four units when the TZT2BB is included). NavNet TZtouch (TZT9/14/BB) and TZTL12F/15F of NavNet TZtouch2 cannot be connected. For connection combinations, see page xxi.)

\*3: Use a commercially available PoE hub. The NETGEAR GS108PE has tested as compatible. The basic functions of the hub were verified, however the compatibility of all functions were not checked. FURUNO cannot guarantee proper operation.

\*4: Available when FUSION-Link compatible equipment is connected via Ethernet.

\*5: When connected to a USB host device using USB OTG (USB), this unit operates as a touch operation output device.

\*6: The output image of HDMI OUT is fixed at 1920×1080. For a touch monitor, the resolution must be 1920×1080 (16:9 aspect ratio) and have HPD (Hot Plug Detection).

\*7: Only DRS6A-NXT supports 12 to 24 V.DC

\*8: DRS4D X-Class can only be used in Japan.

\*9: DRS2D-NXT and DRS4D-NXT cannot be used in Japan.

\*10: Only TZT16X is supported.

**TZT series network connections**

The TZT series can be connected on the same network in the following combinations.

	<b>TZtouch: TZT9/14/BB</b>	<b>TZtouch2: TZTL12F/15F</b>	<b>TZtouch2: TZT2BB<sup>*1</sup></b>	<b>TZtouch3: TZT9F/12F/16F/19F<sup>*2</sup></b>
TZtouchXL: TZT16X/22X/ 24X	No	No	Yes	Yes

<sup>\*1</sup>: Version 9.70 or later

<sup>\*2</sup>: Version 3.70 or later

# EQUIPMENT LISTS

## Standard supply

Name	Type	Code No.	Qty	Remarks
Multi Function Display	TZT16X	-	1	Including installation materials, accessories and spare parts.
	TZT22X	-	1	
	TZT24X	-	1	

## Optional supply

Name	Type	Code No.	Remarks
NMEA Data Converter	IF-NMEA2K2	000-020-510	
Remote Control Unit	MCU-005	000-035-097	
	MCU-006	000-042-803	
	MCU-006H	000-042-804	
Junction Box	FI-5002	005-008-400	
Ethernet HUB	HUB-101	000-011-762	
Joint Box	TL-CAT-012	000-167-140	For LAN network
Rectifier	PR-62	000-013-484	100 VAC
		000-013-485	110 VAC
		000-013-486	220 VAC
		000-013-487	230 VAC
AC/DC Power Supply Unit	PR-241	-	
Ferrite Core	OP86-11	001-594-450	For PR-241
External Buzzer	OP03-136	000-086-443	Buzzer: PKB5-3A40
Network (LAN) Cable	FRU-RZWPNWP-002G	000-200-338-10	Single connector waterproofed
	FRU-RZWPNWP-005G	000-200-339-10	
	FRU-RZWPNWP-010G	000-200-340-10	
	FRU-RZWPWP-002G	000-200-335-10	Dual connector waterproofed
	FRU-RZWPWP-005G	000-200-336-10	
	FRU-RZWPWP-010G	000-200-337-10	
MULTI Cable	FRU-CCCAF14-R001G	000-200-330-10	
NMEA Cable Assy.	FRU-NMEA-PMMFF-010	001-533-060	1 m, two connectors
	FRU-NMEA-PMMFF-020	001-533-070	2 m, two connectors
	FRU-NMEA-PMMFF-060	001-533-080	6 m, two connectors
	FRU-NMEA-PFF-010	001-507-010	1 m, single connector
	FRU-NMEA-PFF-020	001-507-030	2 m, single connector
	FRU-NMEA-PFF-060	001-507-040	6 m, single connector
	FRU-MM1MF1MF1001	001-507-050	T connector
	FRU-MM1000000001	001-507-070	Male, terminator
	FRU-MF000000001	001-507-060	Female, terminator
Cable Assy.	FRU-HDDAP-005G	000-200-334-10	HDMI cable
USB Cable	FRU-UPCAP300UB	000-200-331-10	USB-A/USB-B cable
	FRU-UAP300UAJC-30G	000-200-332-10	USB-A/USB-A cable
USB OTG Cable	FRU-MAEF05-MBJ0300G	000-200-333-10	Micro USB cable
Matching Box	MB-1100	000-027-226	For 1kW transducers

## EQUIPMENT LISTS

Name	Type	Code No.	Remarks	
Transducer	520-5PSD	000-015-204	For TZT16X only.	
	520-5MSD	000-015-212		
	525-5PWD	000-027-447		
	520-PLD	000-023-680		
	525T-BSD	000-023-020		
	525T-PWD	000-023-019		
	SS60-SLTD/12	000-023-676		
	SS60-SLTD/20	000-023-677		
	525T-LTD/12	000-023-679		
	525T-LTD/20	000-023-678		
	50/200-1T *10M*	000-015-170		For TZT16X only. Require MB-1100 for connection (available separately).
	50B-6 *10M*	000-015-042		
	50B-6B *15M*	000-015-043		
	200B-5S *10M*	000-015-029		
Transducer (For CHIRP Side Scan)	225T-TM904	000-044-573	For TZT16X only.	
	225T-SS904	000-044-574		
	225T-PR904	000-044-575		
	455T-TM903	000-044-576		
	455T-SS903	000-044-577		
	455T-PR903	000-044-578		
CHIRP Transducer (for internal fish finder)	TM150M	000-035-500	For TZT16X only.	
	B-75L	000-035-501		
	B-75H	000-035-502		
	B-175H	000-035-504		
	B-175L	000-035-503		
	B265LH-FJ12* <sup>2</sup>	000-037-609		
	CM265LH-FJ12* <sup>2</sup>	000-037-610		
TM265LH-FJ12* <sup>2</sup>	000-037-611			
Triducer	526TID-HDD	000-023-021		
	525STID-MSD	000-011-783		
	525STID-PWD	000-011-784		
Extension Cable* <sup>1</sup>	C332 10M	001-464-120	For transducer cable extension (For TZT16X only).	
	FRU-CCB12-DA-10M	000-198-935-10		
Bracket Assembly	JE07012-B043	000-201-141-10	For TZT16X only.	
User's Guide	E42-02210-*	000-200-313-10	For MCU-006	
Operator's Manual	OME-45240-*	000-200-138-10		

\*1: Use of the extension cable may cause the following problems:

- Reduced detection ability
- Wrong ACCU-FISH™ information (fish length smaller than actual length, fewer fish detections, error in individual fish detection).
- Wrong speed data
- No TD-ID recognition

\*2: Cannot be used simultaneously with the CHIRP side scan transducers.

# 1. MOUNTING

---

## 1.1 Installation of Multi Function Display

The TZT16X/22X/24X is designed to be mounted in a console or mounted on a desk-top (TZT16X only).

The installer of this equipment must read and follow the descriptions in this manual. Wrong installation or improper maintenance can void the warranty.

### 1.1.1 Mounting considerations

When selecting a mounting location for TZT16X/22X/24X, keep the following in mind:

- The temperature at the mounting location shall be between  $-15^{\circ}\text{C}$  and  $+55^{\circ}\text{C}$ .
- The humidity at the mounting location shall be 93% or less at  $40^{\circ}\text{C}$ .
- Locate the unit away from exhaust pipes and ventilators.
- The mounting location should be well ventilated.
- Mount the unit where shock and vibration are minimal (compliant with IEC 60945 Ed.4).
- Keep the unit away from electromagnetic field generating equipment such as motors and generators.
- For maintenance and checking purposes, leave sufficient space around the unit and leave slack in cables. Minimum recommended maintenance space is shown in the outline drawing for the display units.
- A magnetic compass will be affected if the equipment is placed too close to it. Observe the compass safe distances shown in "SAFETY INSTRUCTIONS" to prevent disturbance to the magnetic compass.
- In the below cases, use the mounting plates to reinforce the mounting location.
  - When removing and installing this unit repeatedly.

## 1.2 Flush Mounting

Referring to the figure below, select a flat mounting location. Read the installation instructions before starting. Pay particular attention to the notes; failure to follow these instructions may cause damage to the unit.

**Note:** Ensure the mounting location is flat, with no indents or protrusions, to allow a secure fit.

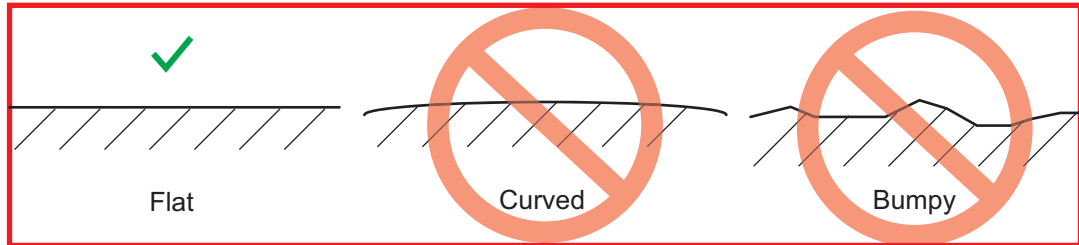

1. Prepare a cutout in the mounting location using the template supplied at the back of this manual.
2. Drill holes at each screw location (with mounting plate: total 20 for 22X/24X, 16 for 16X; without mounting plate: 12 for 22X/24X, 8 for 16X), using the supplied template.
3. For installations with no mounting plate, go to step 4. For installations with a mounting plate, fit the mounting plate to the inner side of the cutout, then secure the plate in place with two M3×25 self-tapping screws (included as installation materials) per plate (total 8 places, indicated in the following figure).

Self-tapping screws (M3x25, 8 places)

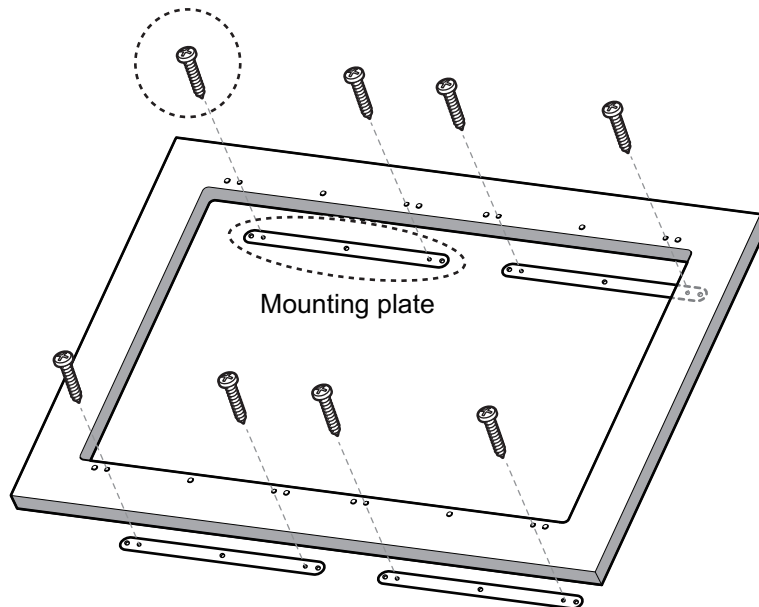

4. Connect all cables at the back of the TZT16X/22X/24X (see section 2.1 for details).

5. Set the TZT16X/22X/24X to the cutout made at step 1. For installations using the mounting plate, the screws fitted at step 4 should align with the gaps in the unit.

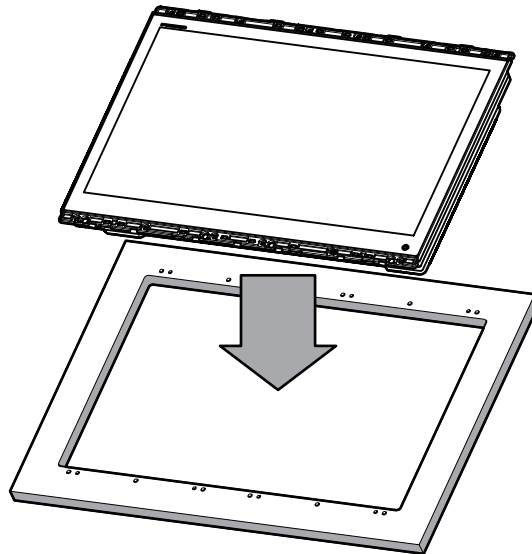

**Note 1:** Cables not shown in figure for simplification.

**Note 2:** Take care not to pinch the cables when fitting the unit.

6. Fasten 12 screws at the locations indicated in the following figure to secure the unit.

With mounting plate: Use M4×30 self-tapping screws.

No mounting plate: Use 4×20 self-tapping screws.

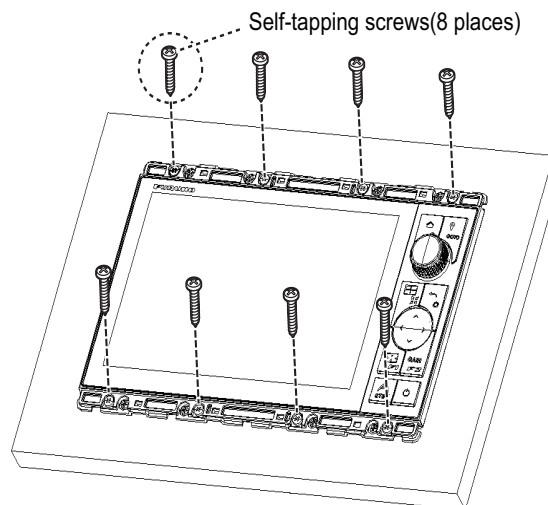

7. Fit the cosmetic plates (included as installation materials) to the top and bottom of the unit front.

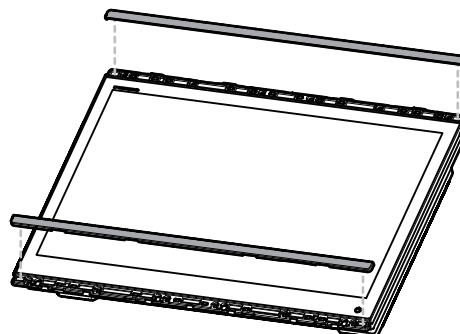

## 1. MOUNTING

### **How to remove the cosmetic plates**

Remove the top and bottom cosmetic plates from the front of the unit.

Using a flat-head screwdriver. Start at one end of the cosmetic plate, insert the blade of the screwdriver into each of the release points (indicated with gray arrows in the figure below), then gently twist the screwdriver until a “pop” sound is heard.

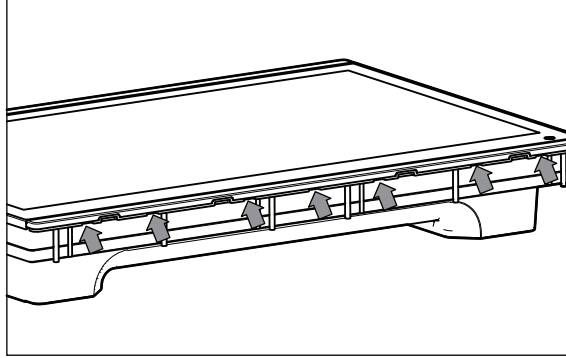

**Note 1:** To prevent damage to the cosmetic plate, release the plate from one end, then work towards the opposite end. Releasing the plate in any other manner may cause damage to the plate and your TZT16X/22X/24X.

**Note 2:** Do not use excessive force when removing the cosmetic plate. Use of excessive force can damage the cosmetic plate and the unit.

### **1.2.1 Retrofit for TZT16X (local supply)**

When upgrading to the TZT16X, prepare the remounting panel. See the outline drawing of the remounting for the details.

**Note:** The outline drawing assumes upgrading from the following models.

- TZT14
- TZTL15F
- TZT16F



## 1.3 Desktop Mounting (TZT16X only, option)

The following procedure shows how to install the TZT16X on a desktop with the optional hanger.

1. Fix the hanger by using self-tapping screws (5 × 20 SUS304, supplied). The screw locations are indicated in the figure below.

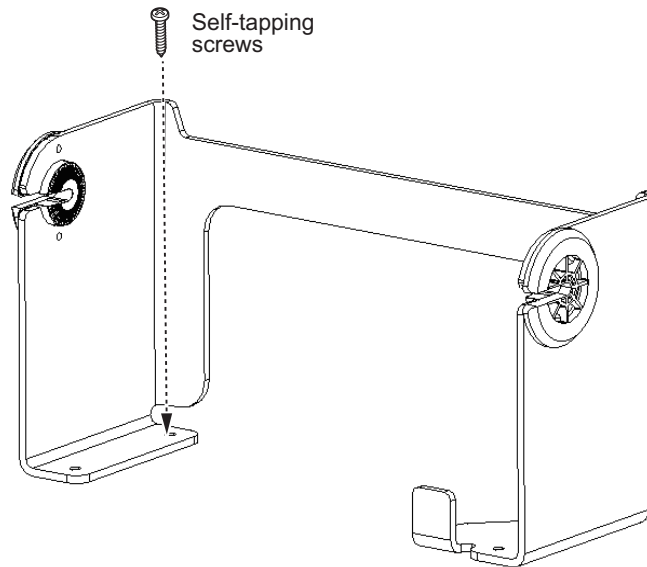

2. Place the unit face-down on a soft/clean surface, then unfasten the knob bolts on either side of the unit.

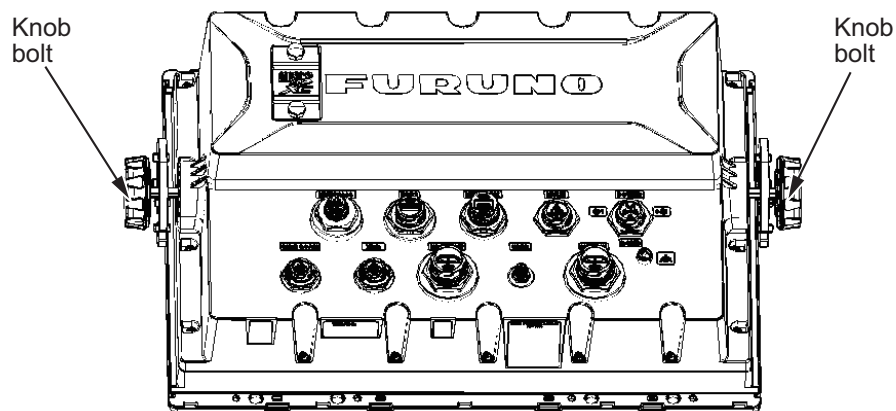

## 1. MOUNTING

3. Set the TZT16X unit to the hanger and tighten the knob bolts.

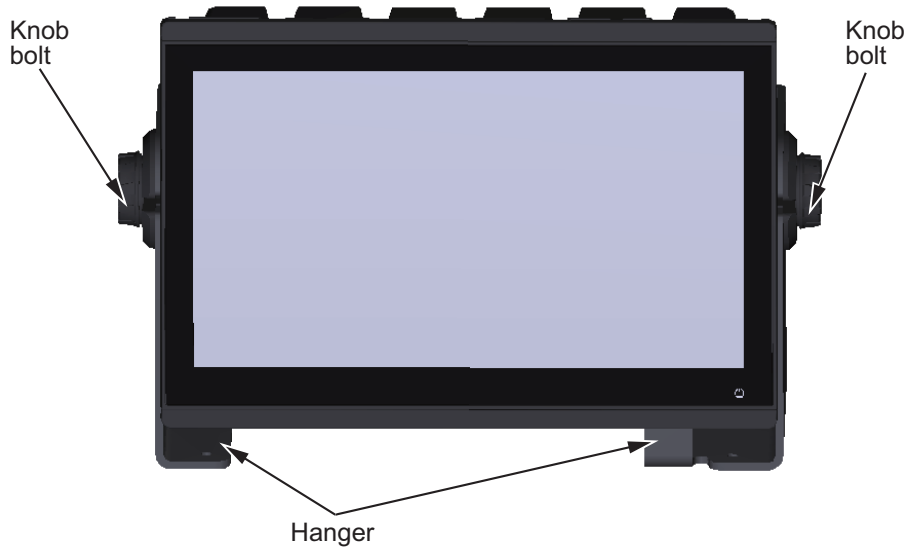

## 1.4 Installation of Transducers (TZT16X only)

### CAUTION



**Do not cover the transducer with FRP resin.** The heat generated when the resin hardens may damage the transducer. CHIRP transducers are especially vulnerable to heat.

**Note:** For instructions regarding installation of network fish finder transducers, see the respective manual.

There are three methods for installing the transducer on the ship (thru-hull mount, inside the hull and transom mount) and one of those methods is to be selected according to the structure of the ship. The procedure which follows below shows how to install a small transducer (520-5PSD/5MSD) as the representative example of installation.

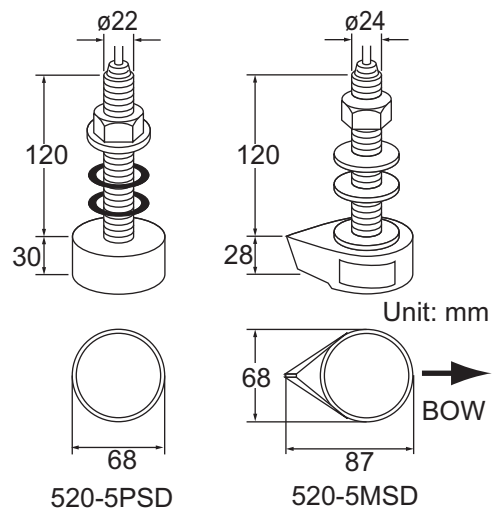

### 1.4.1 How to mount a transducer through the hull

#### Transducer mounting location

The thru-hull mount transducer provides the best performance of all, since the transducer protrudes from the hull and the effect of air bubbles and turbulence near the hull skin is reduced. If your boat has a keel, the transducer should be at least 30 cm away from it.

The performance of this fish finder is directly related to the mounting location of the transducer, especially for high-speed cruising. The installation should be planned in advance, keeping the length of the transducer cable and the following factors in mind:

- Air bubbles and turbulence caused by movement of the boat seriously degrade the sounding capability of the transducer. The transducer should, therefore, be located in a position where water flow is the smoothest. Noise from the propellers also adversely affects performance and the transducer should not be mounted nearby. The lifting strakes are notorious for creating acoustic noise, and these must be avoided by keeping the transducer inboard of them.

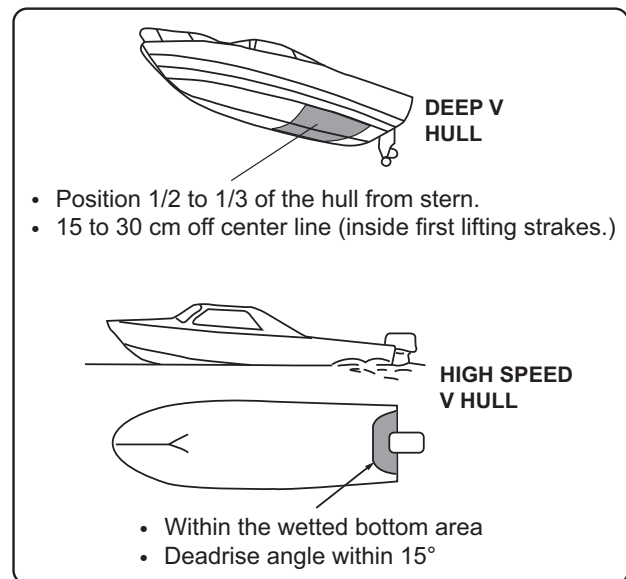

- The transducer must always remain submerged, even when the boat is rolling, pitching or up on a plane at high speed.
- A practical choice would be somewhere between 1/3 and 1/2 of your boat's length from the stern. For planing hulls, a practical location is generally rather far astern, so that the transducer is always in water regardless of the planing attitude.

### **Installation procedure**

1. With the boat hauled out of the water, mark the location chosen for mounting the transducer on the bottom of the hull.
2. If the hull is not level within 15° in any direction, fairing blocks made out of teak should be used between the transducer and hull, both inside and outside, to keep the transducer face parallel with the water line. Fabricate the fairing block as shown below and make the entire surface as smooth as possible to provide an undisturbed flow of water around the transducer. The fairing block should be smaller than the transducer itself to provide a channel to divert turbulent water around the sides of the transducer rather than over its face.

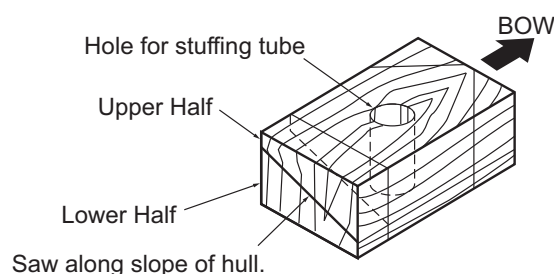

3. Drill a hole just large enough to pass the threaded stuffing tube of the transducer through the hull, making sure it is drilled vertically.
4. Apply a sufficient amount of high quality caulking compound to the top surface of the transducer, around the threads of the stuffing tube and inside the mounting hole (and fairing blocks if used) to ensure watertight mounting.

## 1. MOUNTING

5. Mount the transducer and fairing blocks and tighten the locknut. Be sure that the transducer is properly oriented and its working face is parallel to the waterline.

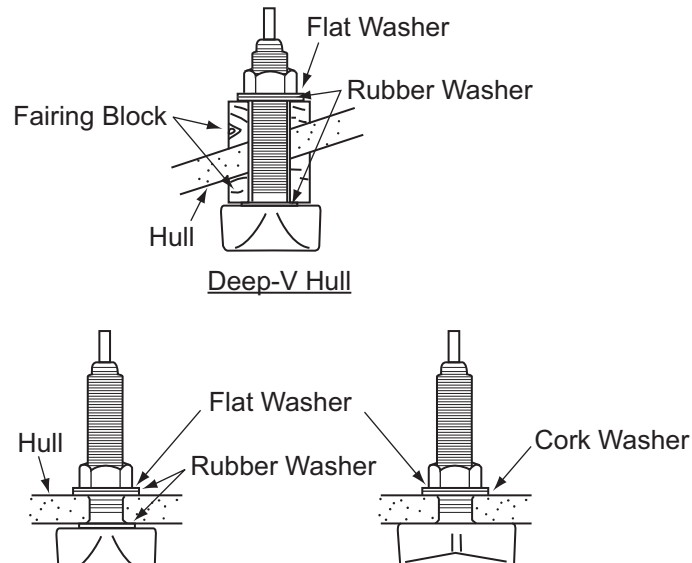

**Note:** Tightening torque should not exceed 39 N•m. Over-tightening will damage the plastic screws.

### 1.4.2 How to mount a transducer inside the hull

#### NOTICE

This installation method affects the ability to detect the bottom, fish and other objects because the ultrasound pulse is weakened when it passes through the hull. Therefore, refrain from this mounting method for a transducer that supports the RezBoost™ (Enhanced Mode), ACCU-FISH™ and/or bottom discrimination display feature.

#### Remarks on installation

This method is useful when mounting a transducer inside the hull of FRP ship, however, it affects the ability to detect the bottom, fish and other objects.

- Do the installation with the ship moored at a dock, etc. The water depth should be 6.5 to 32 feet (2 to 10 meters).
- Turn off the engine.
- Do not power the unit with the transducer in the air, to prevent damage to the transducer.
- Do not use this method on a double layer hull.
- Before attaching the transducer to the hull, check that the site is suitable, by following steps 1 to 3 in the "Installation procedure" on page 1-10.

#### Necessary tools

The following tools are required:

- Sandpaper (#100)
- Marine sealant
- Water-filled plastic bag

### Selecting a location to install the transducer



Install the transducer on the hull plate inside of the engine room. The attenuation of the ultrasound pulse varies with the thickness of the hull. Select a location where attenuation is the lowest.

Select 2-3 locations considering the four points mentioned below.

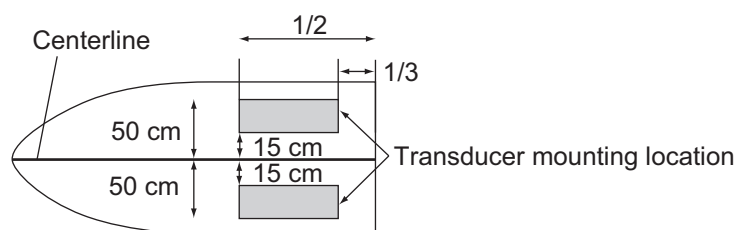
- Mount the transducer at a location  $1/2$  to  $1/3$  of the length of your boat from the stern.
- The mounting location is between 15 to 50 cm from the centerline of the hull.
- Do not place the transducer over hull struts or ribs which run under the hull.
- Avoid a location where the rising angle of the hull exceeds  $15^\circ$ , to minimize the effect of the boat's rolling.



Decide the most suitable site from the locations selected with the following procedures.

1. Connect the power cable and transducer cable to the display unit.
2. Put the transducer into a water-filled plastic bag. Press the transducer against the chosen site.
3. Tap  (power switch) to turn the power on.
4. After the startup procedure completes (approx. 90 seconds), the last used display appears. Tap the [FURUNO] icon (  ) to show the home screen and display mode settings. See section 3.3 for how to use the menu.
5. Scroll the menu to show [Fish Finder] in the menu, then tap [Fish Finder].
6. Scroll the [Fish Finder] menu to show the [User Settings] menu, then tap [Fish Finder Source].
7. Confirm the available fish finder from the list of available sounders, then tap the appropriate fish finder. For the purpose of this example, the default setting [TZT16X] (internal sounder) is selected as the source.
8. Tap the [ $<$ ] icon to return to the [Fish Finder] menu.
9. Scroll the [Fish Finder] menu to show the [Fish Finder Initial Setup] menu, then tap [Transducer Setup].
10. Tap [Transducer Setup Type].
11. Tap [Model].
12. Tap the [ $<$ ] icon to return to [Transducer Setup] menu.
13. Tap [Model Number], scroll the menu to show your transducer model, then tap the transducer model number.
14. Tap the [ $<$ ] icon twice to return to the [Fish Finder] menu, then scroll the [Fish Finder] to show the [Fish Finder Initial Setup] menu.

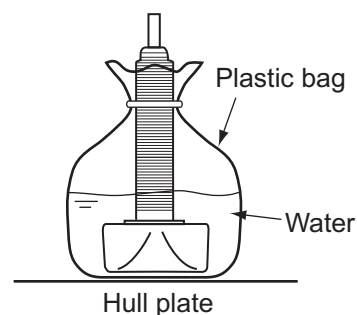

## 1. MOUNTING

15. At the [Transmission Power] menu item, set the transmission power to a level of [Max].
16. Scroll the menu to show [Fish Finder Transmit], then tap [Fish Finder Transmit]. Check if the bottom echo appears on the right side of the screen, in the display area.  
If no bottom echo appears, repeat the procedure until a suitable location is found.
17. Turn off the power of the control unit and remove the transducer from the plastic bag and wipe the face of transducer with a cloth to remove water and any foreign material.

### **Installation procedure**

1. Lightly roughen the transducer face with #100 sandpaper. Also, use the sandpaper to roughen the inside of the hull where the transducer is to be mounted. Wipe off any sandpaper dust from the face of the transducer.
2. Dry the face of the transducer and the hull. Coat the transducer face and mounting location with marine sealant. Hardening begins in approx. 15 to 20 minutes so do this step without delay.

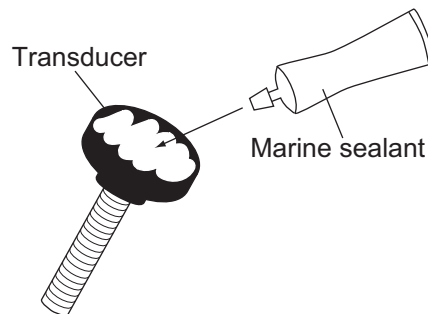

3. Attach the transducer to the hull. Press the transducer firmly down on the hull and gently twist it back and forth to remove any air which may be trapped in the marine sealant.

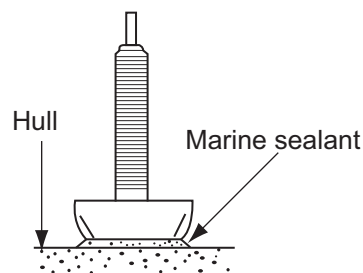

4. Support the transducer with a piece of wood to keep it in place while the sealant is drying. It takes 24 to 72 hours to harden completely.
5. Turn the power on and change the menu setting as shown below. See section 3.3 for how to use the menu.
  - 1) Tap the [FURUNO] icon (  ) to show the home screen and display mode settings.
  - 2) Scroll the menu to show [Fish Finder] in the menu, then tap [Fish Finder Initial Setup] menu.
  - 3) At the [Transmission Power Mode] menu item, set the transmission power to a level of [Max].

- 4) Adjust the Bottom Level and Gain Offset settings as shown in the table below.

Menu Item	Setting
Bottom Level HF	-40
Bottom Level LF	-40
Gain Offset HF	20
Gain Offset LF	20

### 1.4.3 How to install the transom mount transducer

The optional transom mount transducer is very commonly employed, usually on relatively small I/O or outboard boats. Do not use this method on an inboard motor boat because turbulence is created by the propeller ahead of the transducer.

DO NOT over-tighten screws, to prevent damage to the transducer.

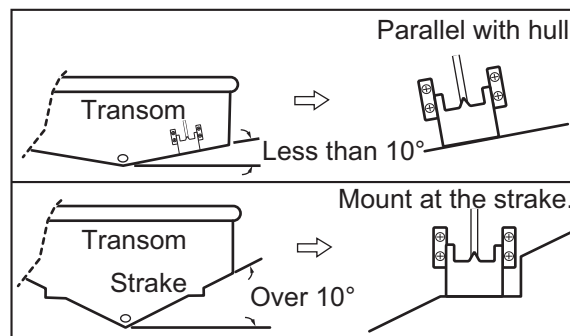

## 1. MOUNTING

### Installation procedure

A suitable mounting location is at least 50 cm away from the engine and where the water flow is smooth.

1. Drill four pilot holes for self-tapping screw (5×20) in the mounting location.
2. Coat the threads of the self-tapping screws (5×14) for the transducer with marine sealant for waterproofing. Attach the transducer to the mounting location with the self-tapping screws.
3. Adjust the transducer position so the transducer faces right to the bottom. If necessary, to improve water flow and minimize air bubbles staying on the transducer face, incline the transducer about 5° at the rear. This may require a certain amount of experimentation for fine tuning at high cruising speeds.
4. Tape the location shown in the figure below.
5. Fill the gap between the wedge front of the transducer and transom with epoxy material to eliminate any air spaces.
6. After the epoxy hardens, remove the tape.

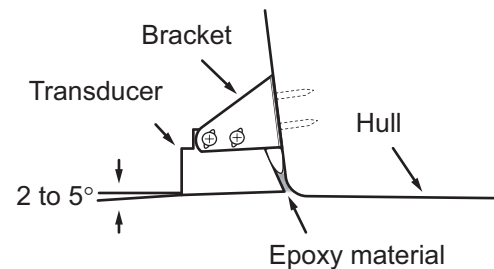
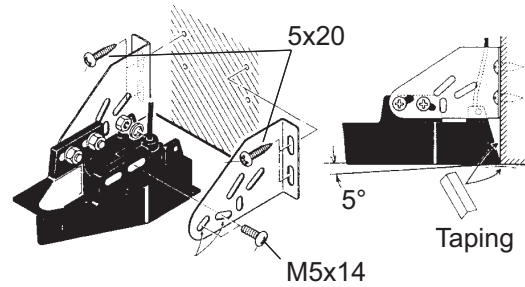

### Transducer protrusion

If the hull is not level within 15° in any direction, install the transducer so that it protrudes from the hull, to keep the transducer face parallel with the water line, not with the hull.

This installation method has a merit for avoiding the bubbles by diverting turbulent water around the sides of the transducer rather than over its face. However, it may cause damage to the transducer during trailering, launching, hauling, and storage.

### Transducer preparation

Before putting your boat in water, wipe the face of the transducer thoroughly with a liquid detergent. This will lessen the time necessary for the transducer to have good contact with the water. Otherwise the time required for complete "saturation" will be lengthened and performance will be reduced.

**DO NOT** paint the transducer. Performance will be affected.

### 1.4.4 How to install a triducer

**DO NOT** over-tighten screws, to prevent damage to the transducer.

### Tools and materials required

- Scissors
- Safety goggles
- Electric drill
- Masking tape
- Dust mask
- Screwdrivers



- Drill bit:  
For bracket holes: 4 mm, #23, or 9/64"  
For fiberglass hull: chamfer bit (preferred), 6 mm, or 1/4"  
For transom hole: 9 mm or 3/4" (optional)  
For cable clamp holes: 3 mm or 1/8"

- Straight edge
- Marine sealant
- Pencil
- Cable ties
- Water-based anti-fouling paint (mandatory in salt water)

**525STID-MSD**

The optional triducer 525STID-MSD is designed for thru-hull mounting. Note the following points when installing.

- Select a location where turbulence or bubbles do not occur when cruising.
- Select a location where noises from propellers and stripe lines are lessen.
- The transducer must always remain submerged, even when the boat is rolling, pitching or up on a plane at high speed.

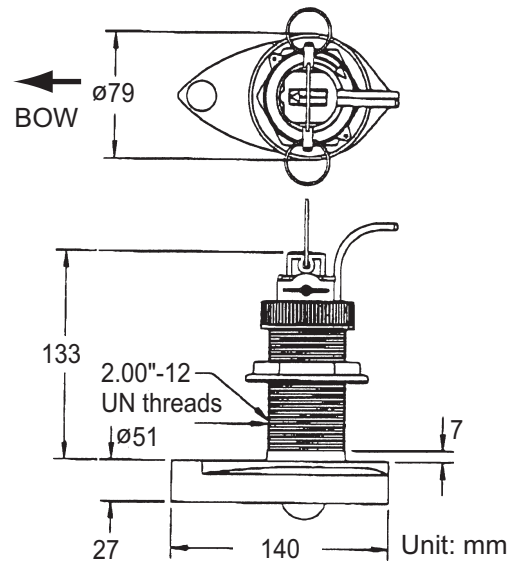

**525STID-PWD**

The optional triducer 525STID-PWD is designed for transom mounting.

Select the location where influences from bubbles and turbulences to ensure the best performance. Allow adequate space above the bracket for it to release and rotate the sensor upward as shown in the right illustration.

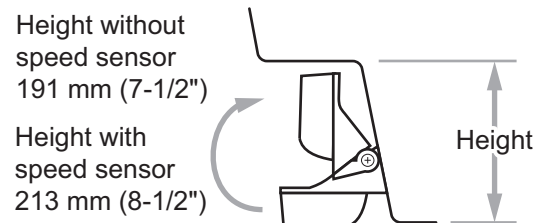

Mount the sensor close to the centerline of your boat. On slower heavier displacement hulls, positioning it farther from the centerline is acceptable.

**For single drive boat,** mount on the star-board side at least 75 mm (3") beyond the swing radius of the propeller, as shown in the right figure.

**For twin drive boat,** mount between the drives.

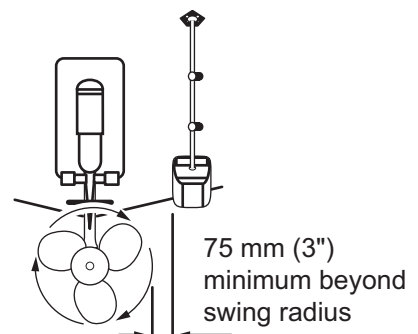

**Note 1:** Do not mount the sensor in an area of turbulence or bubbles, near water in-take or discharge openings; behind strakes, struts, fittings, or hull irregularities; behind eroding paint (an indication of turbulence).

**Note 2:** Avoid mounting the sensor where the boat may be supported during trailering, launching, hauling, and storage.

## 1. MOUNTING

### **Pretest for speed and temperature**

Connect the sensor to the instrument and spin the paddlewheel. Check for a speed reading and the approximate air temperature. If there is no reading, return the sensor to your place of purchase.

### **How to install the bracket**

1. Cut out the installation template (enclosed with transducer) along the dotted line.
2. At the selected location, position the template, so the arrow at the bottom is aligned with the bottom edge of the transom. Being sure the template is parallel to the waterline, tape it in place.

**Warning:** Always wear safety goggles and a dust mask.

3. Using a 4 mm, #23, or 9/64" bit, drill three holes 22 mm (7/8") deep at the locations indicated. To prevent drilling too deeply, wrap masking tape around the bit 22 mm (7/8") from the point.

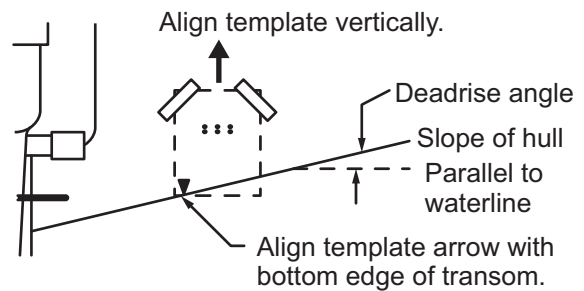

**Fiberglass hull:** Minimize surface cracking by chamfering the gelcoat. If a chamfer bit or countersink bit is not available, start drilling with a 6mm or 1/4" bit to a depth of 1 mm (1/16").

4. If you know your transom angle, the bracket is designed for a standard 13° transom angle.  
11°-18° angle: No shim is required. Skip to step 3 in "Adjustments".  
Other angles: The shim is required. Skip to step 2 of "Adjustments".  
If you do not know the transom angle, temporarily attach the bracket and sensor to the transom to determine if the plastic shim is needed.

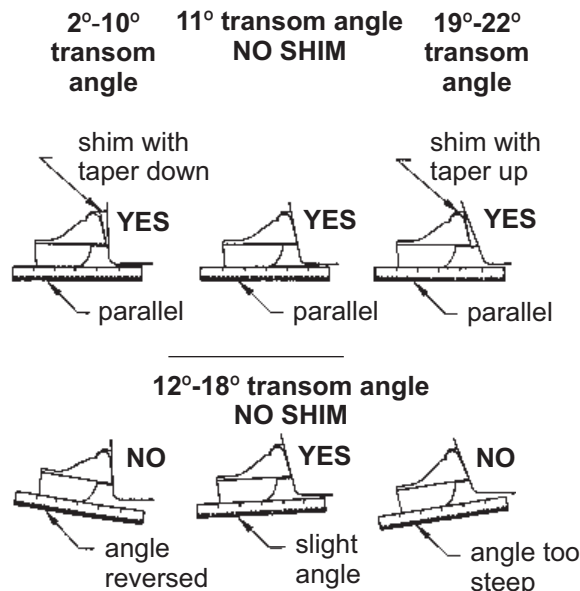

5. Using the three #10 x 1-1/4" self-tapping screws, temporarily screw the bracket to the hull. DO NOT tighten the screws completely at this time. Follow steps 1-4 in "How to attach the sensor to the bracket", before proceeding with "Adjustments".

### Adjustments

- Using a straight edge, sight the underside of the sensor relative to the underside of the hull. The stern of the sensor should be 1-3 mm (1/16-1/8") below the bow of the sensor or parallel to the bottom of the hull.  
**Note:** Do not position the bow of the sensor lower than the stern because aeration will occur.
- To adjust the sensor's angle relative to the hull, use the tapered plastic shim provided. If the bracket has been temporarily fastened to the transom, remove it. Key the shim in place on the back of the bracket.  
**2°-10° transom angle (stepped transom and jet boats):** Position the shim with the tapered end down.  
**19°-22° transom angle (small aluminum and fiberglass boats):** Position the shim with the tapered end up.
- If the bracket has been temporarily fastened to the transom, remove it. Apply a marine sealant to the threads of the three #10×1-1/4" self-tapping screws to prevent water seeping into the transom. Screw the bracket to the hull. Do not tighten the screws completely at this time.
- Repeat step 1 to ensure that the angle of the sensor is correct.  
**Note:** Do not position the sensor farther into the water than necessary to avoid increasing drag, spray, and water noise and reducing boat speed.
- Using the vertical adjustment space on the bracket slots, slide the sensor up or down to provide a projection of 3 mm (1/8"). Tighten the screws.

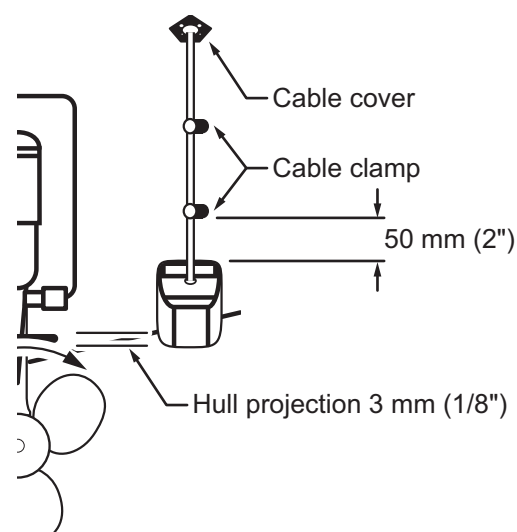

## 1. MOUNTING

### ***How to attach the sensor to the bracket***

1. If the retaining cover near the top of the bracket is closed, open it by depressing the latch and rotating the cover downward.
2. Insert the sensor's pivot arms into the slots near the top of the bracket.
3. Maintain pressure until the pivot arms click into place.
4. Rotate the sensor downward until the bottom snaps into the bracket.
5. Close the retaining cover to prevent the accidental release of the sensor when your boat is underway.

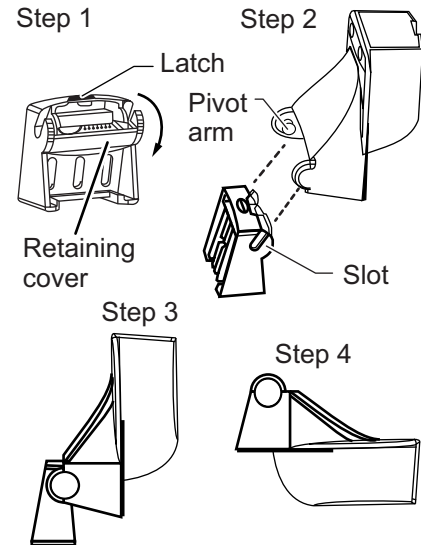

### ***How to route the cable***

Route the sensor cable over the transom, through a drain hole, or through a new hole drilled in the transom above the waterline. If a hole must be drilled, choose a location well above the waterline. Check for obstructions such as trim tabs, pumps, or wiring inside the hull. Mark the location with a pencil. Drill a hole through the transom using a 19 mm or 3/4" bit (to accommodate the connector). Always wear safety goggles and a dust mask.



1. Route the cable over or through the transom. On the outside of the hull secure the cable against the transom using the cable clamps. Position a cable clamp 50 mm (2") above the bracket and mark the mounting hole with a pencil.
2. Position the second cable clamp halfway between the first clamp and the cable hole. Mark this mounting hole.
3. If a hole has been drilled in the transom, open the appropriate slot in the transom cable cover. Position the cover over the cable where it enters the hull. Mark the two mounting holes.
4. At each of the marked locations, use a 3 mm or 1/8" bit to drill a hole 10 mm (3/8") deep. The prevent drilling too deeply, wrap masking tape around the bit 10 mm (3/8") from the point.
5. Apply marine sealant to the threads of the #6 x 1/2" self-tapping screw to prevent water from seeping into the transom. If you have drilled a hole through the transom, apply marine sealant to the space around the cable where it passes through the transom.
6. Position the two cable clamps and fasten them in place. If used, push the cable cover over the cable and screw it in place.
7. Route the cable to the display unit being careful not to tear the cable jacket when passing it through the bulkhead(s) and other parts of the boat. To reduce electrical interference, separate the sensor cable from other electrical wiring and "noise" sources. Coil any excess cable and secure it in place with zip-ties to prevent damage.

## 2. WIRING

### 2.1 Interface Connections (rear of the unit)

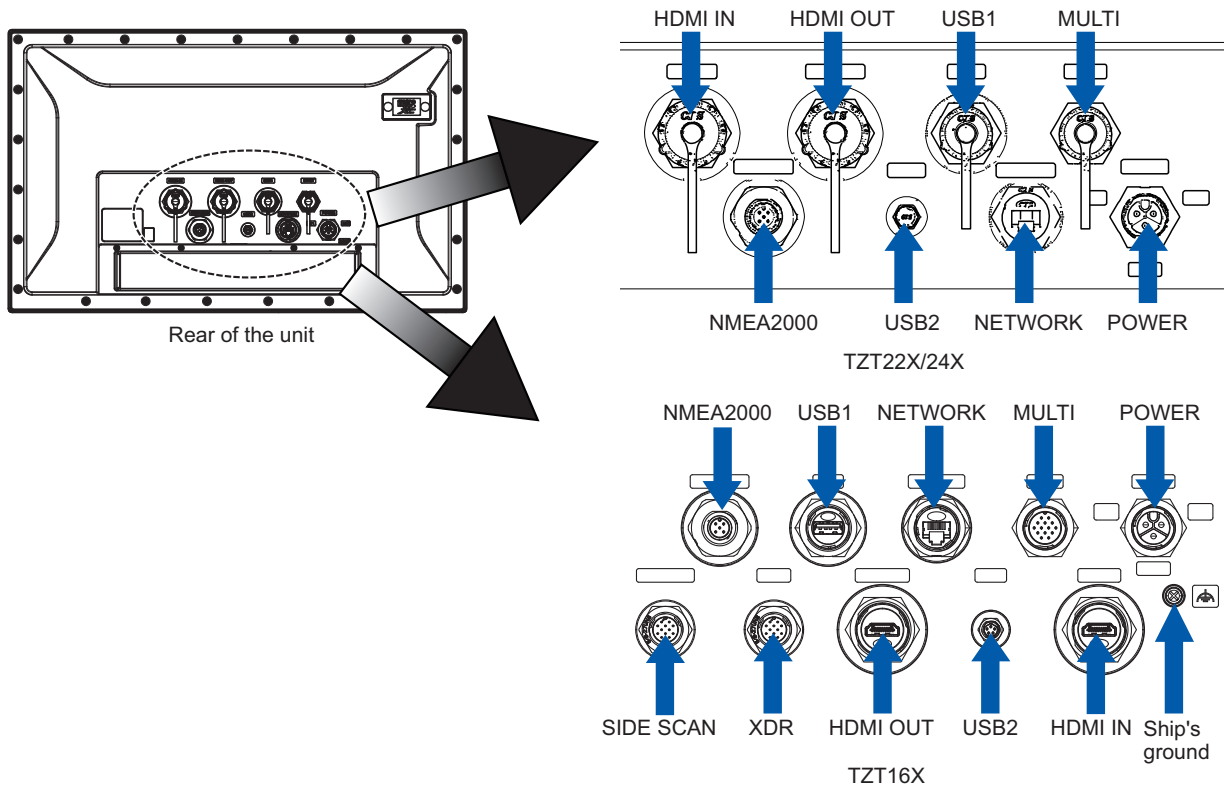

#### **Analog video input**

The TZT16X/22X/24X can use regular analog video inputs (PAL or NTSC) that connect to the TZT16X/22X/24X directly via the Video In connector on the optional MULTI cable (connected to the MULTI port). Analog video can be viewed only on the equipment where the source is connected.

Additionally a single FLIR camera may be connected to the TZT16X/22X/24X. Connect the Video Out cable from the camera to the Video In cable on the TZT16X/22X/24X.

**Note:** Some camera models may require an adapter for connection.

Cameras may be set up using the appropriate menu item on the [Camera] menu, accessed from the [Settings] menu. For details on camera setup, see the operator's manual (OME-45240-x)

#### **Network**

You can connect an external network device using a LAN cable. Use HUB-101 (option) when connecting multiple devices. The MCU-005 can also be connected via a PoE hub.

**Video out (external HDMI monitor)**

A HDMI monitor can be connected to the TZT16X/22X/24X to repeat the screen at a remote location. The TZT16X/22X/24X is compatible with wide-screen HDMI monitors which meet the following minimum requirements:

Resolution	Vert. Frequency	Horiz. Frequency	Pixel clock
1920 × 1080	60 Hz	67.5 kHz	148.5 MHz

**Video in (HDMI Source Devices)**

Video data from HDMI source devices can be watched on TZT16X/22X/24X by connecting the device.

**NMEA2000 (CAN bus) port**

TZT16X/22X/24X can be connected to multiple compatible NavNet TZT units using a micro type NMEA 2000 connector. In that case, connect them all to the same network backbone cable (Refer to section 2.7 for details).

**MULTI port**

You can connect to external devices such as buzzers and event switches. Refer to section 2.4 for details.

**USB port**

The TZT16X/22X/24X has one USB Ver. 2.0 port and one USB Ver. 3.0 port which can be used to connect a remote control unit and/or to control a touch monitor.

**XDR port /SIDE SCAN port(TZT16X only)**

For TZT16X, the type of transducer determines the port to which the transducer cable is connected (Refer to "**TRANSDUCER LIST**" on page AP-12 for details).

**Note 1:** Supply voltages are different depending on XDR ports. Be sure to connect each transducer to the correct port (see the table below).

**Note 2:** When using the optional extension cable (for 10-pin: C332 10M, for 12-pin: FRU-CCB12-DA-10M), keep the following points in mind.

- Detection performance may be degraded.
- False positives (under-display of fish length, reduced number of detections, false detection of single fish) may occur when using the ACCU-FISH™ function.
- Values measured by the ship speed sensor may differ from the actual values.
- TD-ID may not work.

**Note 3:** The below transducers and the CHIRP transducers (dual frequency) cannot be used simultaneously.

- CM265LH-FJ12
- TM265LH-FJ12
- B265LH-FJ12

## 2.2 Power Cable

Connect the power cable (FRU-PM03M-KCP01-RD, 2 m, supplied) to the connector. When connecting the power supply, connect the positive and negative terminals correctly.

**Note:** Turn off the power at the switchboard before beginning the connection.

## 2.3 Grounding Wire (16X only)

Connect a ground wire (IV-8sq., local supply) to the ship's ground terminal on the rear panel with a crimp-on lug ( $\phi 5$ , local supply). Connect the other end to ship's ground.



## 2.4 MULTI Cable

Use the optional MULTI cable for the NMEA 0183 equipment, external buzzer to supply power to the NMEA 2000. The connector has 14 wires and a connector (SMP-11V). Use the table below for reference and connector (SMD-11V, local supply) when connecting the MULTI cable.

Wire color	Function	Description
White	NMEA-TD-B	NMEA 0183 Output
Blue	NMEA-TD-A	
Gray	BUZZER	External buzzer ON/OFF
Red	12 V_OUT+	External buzzer power (12 V)
Orange	EVENT_SW	Event switch (MOB, etc.)
Black	GND	Grounding for +12V/EVENT_SW
Purple	PWR_SW	Power switch
Brown	KPI	5-12 VDC, Positive
Red/White	KPO	12 VDC, Positive
Black/White	GND	Grounding for KP
Brown/White	GND	Grounding for power switch
Braided (external)	SHIELD	FG
Signal	Signal	For video input (RCA Jack)
Braided (internal)	GND	For video signal

### 2.4.1 How to set up NMEA 0183 data output

**Note:** To set up data input from NMEA 0183 equipment, see "NMEA 0183 equipment data input" on page 2-5.

1. Tap the [FURUNO] icon (  ) to show the home screen.
2. Tap [Settings], drag the menu to show [Initial Setup], then tap [Initial Setup].
3. Tap [Data Sensors], then tap [NMEA0183 Output].
4. Tap [Baud Rate] to set the output baud rate. Available options are [4,800], [9,600] and [38,400].
5. Tap the appropriate setting then tap the  icon.
6. Tap [NMEA-0183 Version] to set the version. Available options are [1.5], [2.0] and [3.0].

7. Tap the appropriate setting then tap the  icon.
8. Select the sentences to output. Tap a sentence, then tap its flipswitch to set the sentence to [ON].
9. Tap the [Close] icon at the top right of the screen to close the menus.

## 2.5 DRS Radar Sensor Connections

The figures below show connection examples with radar sensors which are compatible with the TZT16X/22X/24X.

For details regarding connection and cables required for connection with the radar sensor, see the radar sensor's installation manual.

**Note:** DRS2D-NXT and DRS4D-NXT cannot be used in Japan.  
 DRS4D X-Class is for Japanese market only.

Connection examples for radome sensors

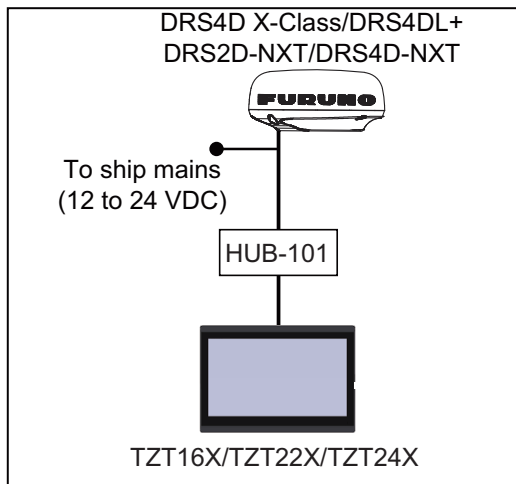

Connection examples for open-array sensors

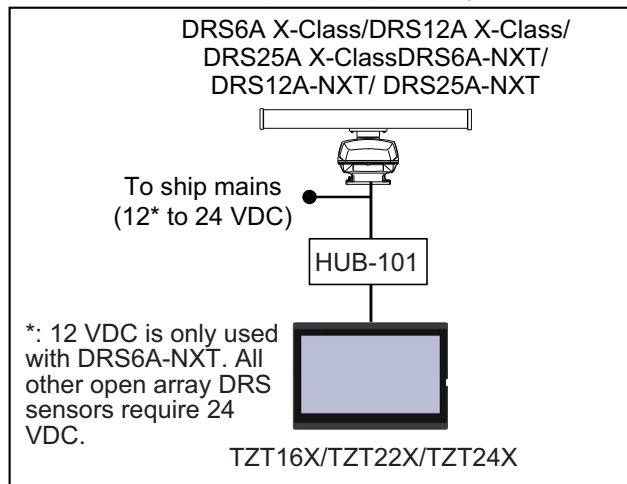

## 2.6 Network Connection with Other TZT Series Units

Your TZT16X/22X/24X is equipped with a network connector (RJ45). Like previous NavNet series equipment, the TZT16X/22X/24X is able to share Radar images and other information, across an Ethernet connection. Up to six NavNet TZtouch units may be connected to the same network at one time (see page iv for the details). However, for configurations with one or more TZT2BB included, the maximum number of networked NavNet TZtouch units is four. For example, a configuration with one TZT16X/22X/24X and one TZT12F can have two TZT2BB units connected.

## 2.7 NMEA 2000 Connector

The TZT16X/22X/24X has one NMEA 2000 connector (micro type connector). All TZT16X/22X/24X must be connected to the same NMEA 2000 backbone.

### What is NMEA 2000?

NMEA 2000 (also known as CAN bus) is a communication protocol that shares multiple data and signals through a single backbone cable. You can simply connect any



NMEA 2000 devices onto the backbone cable to expand your network on-board. With NMEA 2000, IDs are assigned to all the devices in the network, and the status of each sensor in the network can be detected. All the NMEA 2000 devices can be incorporated into the NMEA 2000 network. For detailed information about NMEA 2000 wiring, see "FURUNO CAN bus Network Design Guide" (Type: TIE-00170).

### 2.7.1 How to connect the NavNet TZtouchXL to NMEA 2000 equipment

Below is an example of two units, connected to NMEA 2000 sensors via the network.

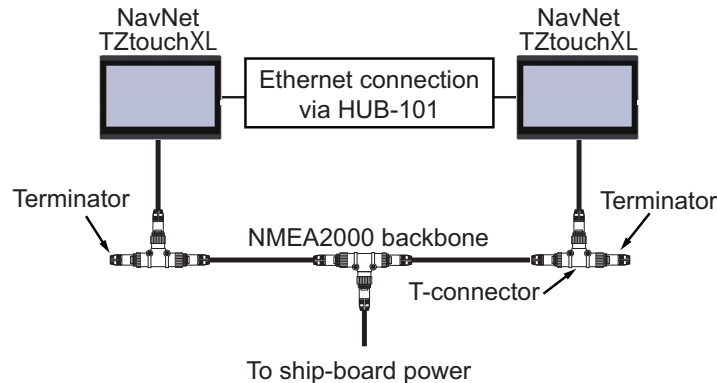

**Note 1:** The NMEA 2000 network requires a dedicated NMEA 2000 power supply. Turn the NMEA 2000 network power on before turning your connected equipment on.

**Note 2:** Terminators must be installed at both ends of the NMEA 2000 backbone cable. See the "EQUIPMENT LISTS" on page v for available terminators.

### 2.7.2 NMEA 0183 equipment data input

**Note:** To output NMEA 0183 data, see section 2.4.1.

To connect NMEA 0183 equipment to TZT16X/22X/24X, use the NMEA 2000 network via the optional NMEA data converter IF-NMEA2K2 (or IF-NMEA2K1). This NMEA connection can accept a baud rate of 4800 or 38400.

Heading input to TZT16X/22X/24X allows functions such as Radar Overlay and course stabilization (North up, etc.) in the radar operating modes. The NMEA 0183 heading refresh rate needs to be 100 ms in order for any radar function to work properly. NMEA 0183 heading can be accepted on any NMEA 2000 port at a baud rate up to 38400 bps.

**Note 1:** When using the ARPA function, set the heading refresh rate to 100 ms.

**Note 2:** For more information on connecting and wiring IF-NMEA2K2, refer to their respective installation manuals.

### 2.7.3 NMEA 2000 input/output

#### Input PGN

PGN	Description
059392	ISO Acknowledgment
059904	ISO Request

## 2. WIRING

<b>PGN</b>	<b>Description</b>
060160	ISO Transport Protocol, Data Transfer
060416	ISO Transport Protocol, Connection Management - BAM group function
060928	ISO Address Claim
061184	Self Test Group Function (Proprietary PGN)
065240	ISO Commanded Address
065280	Heave (Proprietary PGN)
126208	NMEA-Request Group Function
	NMEA-Command Group Function
	NMEA-Acknowledge Group Function
126464	PGN List - Transmit PGN's group function
126720	Memory Clear Group Function (Proprietary PGN)
126992	System Time
126996	Product Information
126998	Configuration Information
127237	Heading/Track Control
127245	Rudder
127250	Vessel Heading
127251	Rate of Turn
127252	Heave
127257	Attitude
127258	Magnetic Variation
127488	Engine Parameters, Rapid Update
127489	Engine Parameters, Dynamic
127493	Transmission Parameters, Dynamic
127498	Engine Parameters, Static
127503	AC Input Status
127505	Fluid Level
127506	DC Detailed Status
127508	Battery Status
128259	Speed
128267	Water Depth
129025	Position, Rapid Update
129026	COG & SOG, Rapid Update
129029	GNSS Position Data
129033	Local Time Offset
129038	AIS Class A Position Report
129039	AIS Class B Position Report
129040	AIS Class B Extended Position Report
129041	AIS Aids to Navigation (AtoN) Report
129291	Set & Drift, Rapid Update
129538	GNSS Control Status
129540	GNSS Satellites in View
129793	AIS UTC and Date Report
129794	AIS Class A Static and Voyage Related Data
129795	AIS Addressed Binary Message
129797	AIS Binary Broadcast Message
129798	AIS SAR Aircraft Position Report
129801	AIS Addressed Safety Related Message
129802	AIS Safety Related Broadcast Message

PGN	Description
129808	DSC Call Information
129809	AIS Class B "CS" Static Data Report, Part A
129810	AIS Class B "CS" Static Data Report, Part B
130306	Wind Data
130310	Environmental Parameters
130311	Environmental Parameters
130312	Temperature
130313	Humidity
130314	Actual Pressure
130316	Temperature, Extended Range
130576	Trim Tab Status
130577	Direction Data
130578	Vessel Speed Component
130817	Furuno GNSS Control Status (Proprietary PGN)
130818	Heading & Attitude Sensor Control Status (Proprietary PGN)
130820	Motion Sensor Status(Proprietary PGN)
130822	130822 Unit Division Code(Proprietary PGN)
130823	Browser Control Status(Proprietary PGN)
130826	Multi Sats In View (Proprietary PGN)
130827	NAVpilot General Message (Proprietary PGN)
130828	Mark Position Information(Proprietary PGN)
130845	Multi Sats in View Extended (Proprietary PGN)
130846	Motion Sensor Status Extended (Proprietary PGN)
130848	Water Current Layer (Proprietary PGN)
130880	Additional Weather Data(Proprietary PGN)

### **Output PGN**

The NMEA 2000 output PGN setting (found under the [Initial Setup] menu) is global to the network. Note that only one TZT16X/22X/24X will output NMEA 2000 data on the network at a time: the TZT16X/22X/24X which is powered ON first. If that display is turned OFF, another will take its place to output the data.

PGN	Description	Output cycle (msec)
059392	ISO Acknowledgement	
059904	ISO Request	
060928	ISO Address Claim	
061184	Self Test Group Function (Proprietary PGN)	
065287	HID Target Status (Proprietary PGN)	
126208	NMEA-Request group function	
	NMEA-Command group function	
	NMEA-Acknowledge group function	
126464	PGN List-Transmit PGN's group function	
	PGN List-Received PGN's group Function	
126720	Memory Clear Group Function (Proprietary PGN)	
126992	System Time	1000
126993	Heartbeat	
126996	Product Information	
126998	Configuration Information	
127250	Vessel Heading	100

## 2. WIRING

<b>PGN</b>	<b>Description</b>	<b>Output cycle (msec)</b>
127251	Rate of Turn	100
127257	Attitude	1000
127258	Magnetic Variation	1000
128259	Speed	1000
128267	Water Depth	1000
128275	Distance Log	1000
129025	Position, Rapid Update	100
129026	COG & SOG, Rapid Update	250
129029	GNSS Position Data	1000
129033	Local Time Offset	1000
129283	Cross Track Error	1000
129284	Navigation Data	1000
129285	Navigation-Route/WP information	
130306	Wind data	100
130310	Environmental Parameters	500
130312	Temperature	2000
130313	Humidity	2000
130314	Actual Pressure	2000
130316	Temp., Extended Range	2000
130821	NAV Source Select (Proprietary PGN)	
130822	Unit Division Code (Proprietary PGN)	
130823	Browser Control Status (Proprietary PGN)	
130827	NAVpilot General Message (Proprietary PGN)	
130841	N2K System Setup Information (Proprietary PGN)	

## 2.8 Example TZT16X/22X/24X System Configuration

### Mid/Large-size vessels (External GPS, Fish Finder, Radar)

This is a sample of the chart plotter/radar/fish finder installation. Refer to "SYSTEM CONFIGURATION" on page iii for more details.

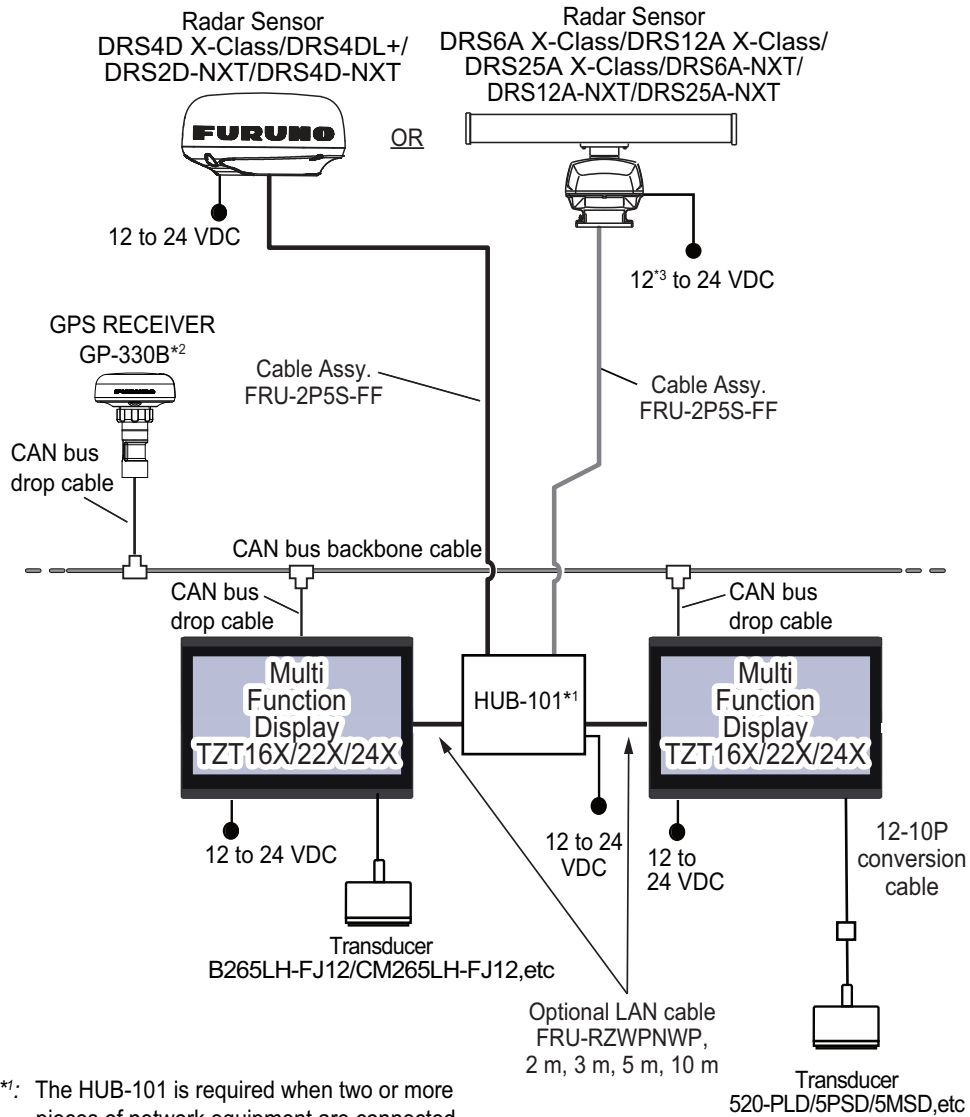

\*1: The HUB-101 is required when two or more pieces of network equipment are connected to the TZT22X/24X.

\*2: Backup

\*3: 12 VDC is only used with DRS6A-NXT.  
All other open array DRS sensors require 24 VDC.

## 2. WIRING





This page is intentionally left blank.

# 3. HOW TO SET UP THE EQUIPMENT

This chapter shows you how to set up your system according to the equipment you have connected.

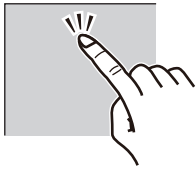

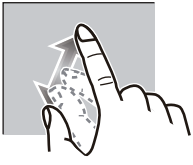
## Touch control description

The touch control depends on the screen type. The basic operations to use during the installation setup are in the following table.

	Operating by a finger	Function
Tap		<ul style="list-style-type: none"> <li>• Select a menu item.</li> <li>• Select a setting option where there are multiple options.</li> <li>• Select an object.</li> <li>• Display the pop-up menu where available.</li> </ul>
Drag		<ul style="list-style-type: none"> <li>• Scroll the menu.</li> </ul>
Pinch	  <p style="text-align: center;">Zoom in                  Zoom out</p>	Change the fish finder, plotter and radar range.

## How to operate the menus

The following procedure shows how to use the menu system.

1. Tap  (power switch) to turn the power on.
2. After the startup process completes, the last-used display appears and a warning message is displayed. Read the message, then tap [OK].
3. Tap the [FURUNO] icon (  ) to show the home screen and available display modes.





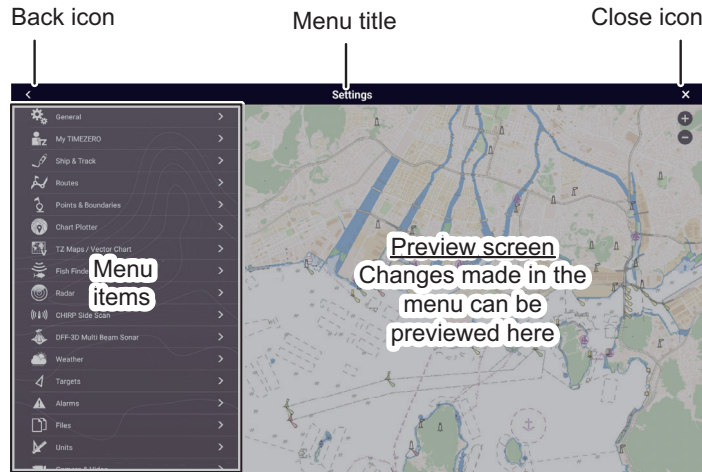

4. Tap [Settings] to open the [Settings] menu.

### 3. HOW TO SET UP THE EQUIPMENT

5. Drag the menu to show [Initial Setup], then tap [Initial Setup].



6. Depending on the menu item selected, the following operations are available:

- ON/OFF flipswitch. ON  OFF   
Tap to switch between ON and OFF to activate or deactivate the function.
- Sidebar and keyboard icon.   
Drag the slider bar to adjust the setting. Settings may also be adjusted using the software keyboard for direct input.
- Keyboard icon.   
Referring to the figure on the following page, use the software keyboard to input alphabet or numeric characters.

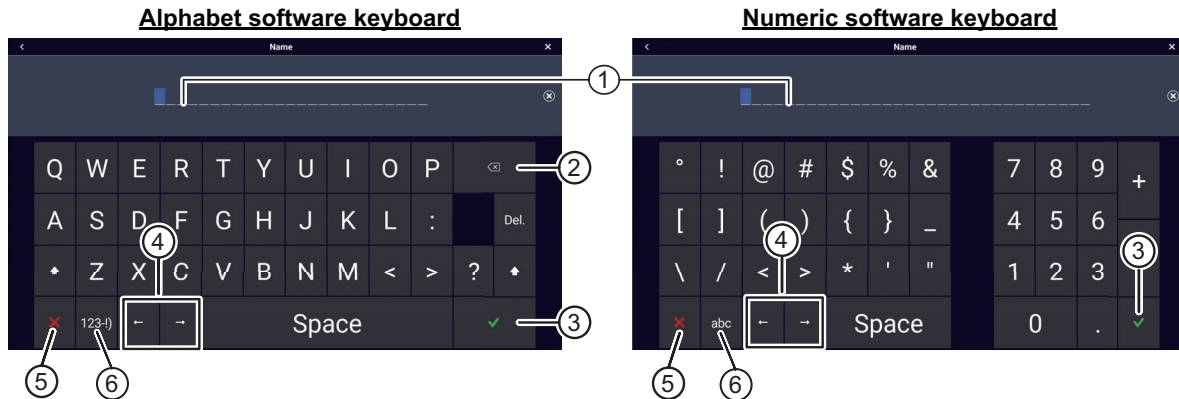

No.	Description
1	Cursor position is highlighted.
2	Backspace/Delete. Tap to erase one character at a time.
3	Enter button. Tap to complete character input and apply changes.
4	Cursor keys. Tap to move the cursor left/right.
5	Cancel button. Aborts character entry. No changes are applied.
6	Tap to switch between alphabet and numeric keyboards (where available).

7. Tap the close button (x) at the top right-hand side of the screen to exit.



## 3.1 How to Set Time Zone, Time Format and Language

Before setting up your equipment, select the time zone, language and units to use on your equipment as shown below.

1. Tap the [FURUNO] icon (  ) to show the home screen and display mode settings.
2. Tap [Settings] to show the [Settings] menu.
3. Tap [General] to show the [General] menu.
4. Tap [Local Time Offset] to show the numerical keyboard.
5. Input the time difference (using 15-minute intervals) between local and UTC , then tap [✓].
6. Drag the menu to show the [Time Format] menu item, then tap [Time Format] to show the option window.
7. Select how to display time, in 12- or 24-hour format. [Auto] automatically inserts AM, PM indication in 24 hour clock, when the language is English.
8. Tap [<] at the top left of the screen to return to the [General] menu.
9. Tap [Language] to show the [Language] menu.

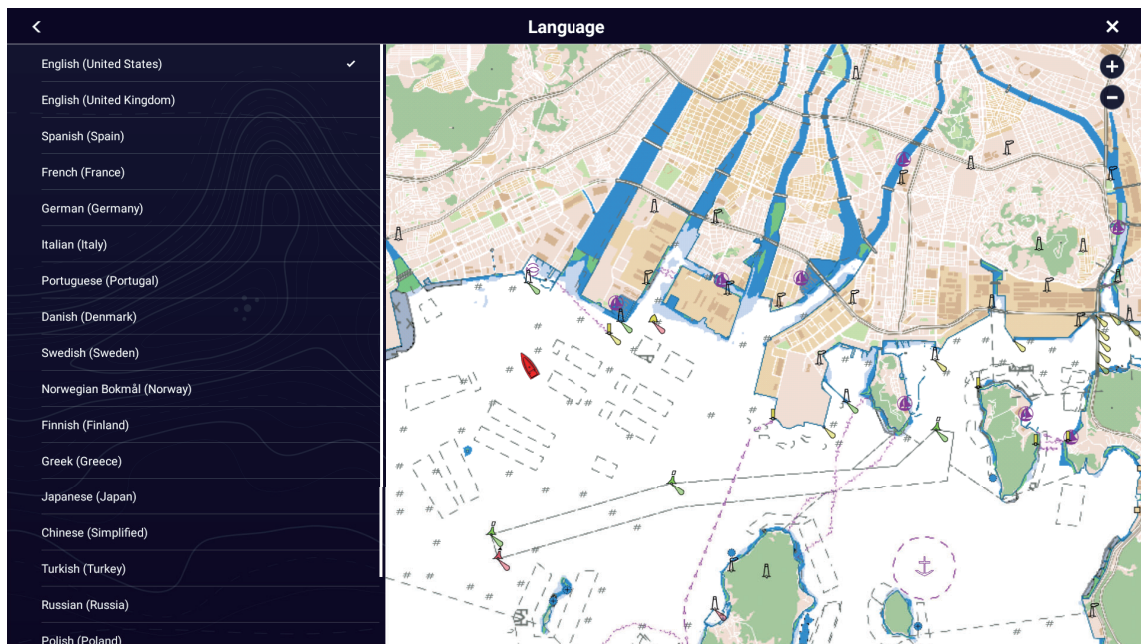

10. Tap the appropriate language to use. The unit will display a confirmation message. Tap [OK] to restart the unit and apply the new language settings. This process takes approximately five minutes to optimize the system for the new language setting. When the process is completed (five minutes later), the system restarts automatically.

## 3.2 How to Set Units of Measurement

1. Tap the [FURUNO] icon (  ) to show the home screen and display mode settings.
2. Tap [Settings] to show the [Settings] menu.
3. Drag the main menu to display [Units], then tap [Units].
4. Referring to the table below, set the units to show on the display.

Menu item	Description	Options
[Bearing Display]	Adjust the bearing display format.	[Magnetic], [True]
[True Wind Calculation Reference]	Set the reference for calculating true wind speed/angle.	[Ground], [Surface]
[Position Format]	Set the display format for position (Latitude/Longitude).	[DDD°MM.mmmm'], [DDD°MM.mmm'], [DDD°MM.mm'], [DDD°MM'SS.ss"], [DDD.ddddd°], [Loran-C], [MGRS]
[Loran C Station &GRI]	Available when [Position Format] is selected to [Loran-C].	Set Loran C station and GRI combination.
[Short/Long Change Over]	Set the distance at which to change between short and long range.	[0.0] to [2.0] (NM)
[Range (Long)]	Set the unit of measurement for long distances.	[Nautical Mile], [Kilometer], [Mile]
[Range (Short)]	Set the unit of measurement for short distances.	[Foot], [Meter], [Yard]
[Depth]	Set the unit of measurement for depth.	[Foot], [Meter], [Fathom], [Passi Braza]
[Height/Length]	Set the unit of measurement for height and length.	[Foot], [Meter]
[Fish Size]	Set the unit of measurement for fish sizes.	[Inch], [Centimeter]
[Temperature]	Set the unit of measurement for temperature.	[Fahrenheit Degree], [Celsius Degree]
[Boat Speed]	Set the unit of measurement for boat speed.	[Knot], [Kilometer per Hour], [Mile per Hour], [Meter per Second]
[Wind Speed]	Set the unit of measurement for wind speed.	[Knot], [Kilometer per Hour], [Mile per Hour], [Meter per Second]
[Atmospheric Pressure]	Set the unit of measurement for atmospheric pressure.	[HectoPascal], [Millibar], [Millimeter of Mercury], [Inch of Mercury]
[Oil Pressure]	Set the unit of measurement for oil pressure.	[KiloPascal], [Bar], [Pound per Square Inch]
[Volume]	Set the unit of measurement for tank volume.	[Gallon] (Gallon &Gallon/hour), [Litre] (Litre &Litre/hour)
[Reset Default Settings]	Restore default unit settings.	[OK], [Cancel]

### 3.3 Initial Setup

This section shows you how to set your system according to the sensors you have connected.

**Note:** Some units are set to metric in this section, actual setting ranges vary depending on the unit of measurement set in the [Units] menu.

1. Tap the **FURUNO** icon (  ) to show the home screen and display mode settings.
2. Tap [Settings] to show the [Settings] menu.
3. Drag the main menu, then tap [Initial Setup] to show the [Initial Setup] menu.
4. Referring to the tables on the following pages, set your equipment.

#### **[Boat Information] section**

Menu item	Description	Options (setting range)
[Boat Height]	Set the height of your boat.	0 (m) to 999 (m)
[Boat Width]	Set the width of your boat.	0 (m) to 999 (m)
[Boat Length]	Set the length of your boat.	0 (m) to 999 (m)
[Boat MMSI]	Set the MMSI for your boat (used for fleet tracking function only).	
[Boat Name]	Set the name for your boat (used for fleet tracking function only).	
[Size of Own Ship Icon]	Set the size of own ship icon.	50 to 150
[Depth Display]	Select the start point for depth measurement.	[Under Keel], [Under Sea Level]
[External Transducer Draft]	Set the draft for external transducers other than internal fish finder, networked or multi-beam sonar. <b>For internal/network transducers</b> , set the draft from Home screen→[Settings]→[Fish Finder]→[Fish Finder Initial Setup]→[Transducer Draft]. <b>For multi-beam sonars</b> , set the draft from Home screen→[Settings]→[Multibeam Sonar]→[Initial Setup]→[Transducer Draft].	0.0 (m) to 99.9 (m)
[Keel Draft]	Set the keel draft.	0.0 (m) to 99.9 (m)
[Engine Count]	Set the number of engines.	0 to 6

#### **[Instruments Setup] section**

Menu item	Description	Options (setting range)
[Engine & Tank Automatic Setup]	See "[Engine & Tank Automatic Setup] section" on page 3-10.	
[Engine & Tank Manual Setup]	See "[Engine & Tank Manual Setup] section" on page 3-10.	
[Graphic Instruments Setup]	See "[Graphic Instruments Setup] section" on page 3-9.	

### 3. HOW TO SET UP THE EQUIPMENT

#### **[Manual Fuel Management] section**

Menu item	Description	Options (setting range)
[Total Fuel Capacity]	Enter the total fuel capacity of your tank(s).	0 to 9,999(L).
[Manual Fuel Management]	Set to [ON] for manual fuel management. See the Operator's Manual.	Off, On
[Reset Default Page Settings]	Resets [Manual Fuel Management] menu settings to default.	

#### **[Data Sensors] section**

Menu Item	Description	Options (setting range)
[Data Sources]	Select the source for each data to input to the system. If two or more sources are connected for a data, select one using the pull-down dialog box. The FURUNO products are shown at the upper part of the list.	
[Sensor List]	Show the information for sensors connected to your equipment. Also, you can set "Nickname" for them here.	
[NMEA0183 Output]	<ul style="list-style-type: none"> <li>• [Baud Rate]: Select the baud rate.</li> <li>• [NMEA-0183 Version]: Select the version for NMEA 0183.</li> </ul>	<ul style="list-style-type: none"> <li>• [4,800], [9,600], [38,400]</li> <li>• [1.5], [2.0], [3.0]</li> </ul>
	[Sentences]: Select the sentences to output. <b>Note:</b> If the TTM sentence is received at the same time as another sentence, the constraints to communication bandwidth may cause a decrease in the number of TTM targets.	Off, On
[NMEA2000 PGN Output]	Turn On for the PGN's (Parameter Group Number, NMEA 2000 message) to output from the NMEA 2000 port. <b>Note:</b> The default setting of some PGNs is "On".	Off, On
[Sky View...]	Show the condition of GPS and GEO (WAAS) satellites on the [GPSSkyView] display. The bearing and elevation angle of all GPS and GEO-satellites (if applicable) in view of your receiver appear. For the serviceman. <b>Note:</b> The [GPS SkyView] display can also be shown by tapping the GPS icon (shown right) on the Home page.	
[GP330B WAAS Mode]	Turn On to use the WAAS mode for the corresponding GPS antenna.	Off, On
[WS200 WAAS Mode]		
[Reset Default Page Settings]	Resets [Data Sensors] menu settings to default.	

#### **[Network Sensor Setup] section**

The [NETWORK SENSOR SETUP] section allows you to set up compatible FURUNO NMEA 2000 sensors. Calibrations and offsets applied in this menu are also applied to the sensor itself.

Tap the sensor to access its menus and settings. For details regarding the menu structure and set up of each sensor, see the appropriate operator's manual, supplied with the sensor.

Menu item	Description	Option (setting range)
[FAX-30 Browser]	Show the Facsimile Receiver FAX-30 display.	

Menu item	Description	Option (setting range)
[FA-30 Browser]	Show the AIS Receiver FA-30 display.	
[FA-50 Browser]	Show the AIS Receiver FA-50 display.	

**[SC-30 Setup] section (only when the SC-30 is connected)**

Menu item	Description	Options (setting range)
[WAAS Mode]	Turn On to use the WAAS mode.	Off, On
[Heading Offset]	Enter the offset value for heading.	-180° to +180°
[Pitch Offset]	Enter the offset value for pitching.	-90° to +90°
[Roll Offset]	Enter the offset value for rolling.	-90° to +90°

**[Data Offset] section**

Menu item	Description	Options (setting range)
[Heading]	Offset heading data.	-180.0° to +180.0°
[Speed Through Water]	Calibrate speed data. Enter amount in percentage.	-50% to +50%
[Wind Speed]	Offset wind speed data. Enter amount in percentage.	-50% to +50%
[Wind Angle]	Offset wind angle data.	-180° to +180°
[Sea Surface Temperature]	Offset sea surface temperature data.	-10°C to +10°C
[Reset Default Page Settings]	Resets [Data Offset] menu settings to default.	

**[GPS Position] section**

Menu item	Description	Options (setting range)
[Longitudinal (from bow)]	Referring to the figure on the right, enter the GPS antenna positioning bow-stern (Longitudinal) and port-starboard (Lateral) position from the origin.	0 (m) to 999 (m)
[Lateral (-Port)]		-99 (m) to +99 (m) Port-side is negative, Starboard-side is positive.
[Reset Default Page Settings]	Resets [GPS Position] menu settings to default.	



**[Data Damping] section**

Menu item	Description	Options (setting range)
[COG & SOG]	Set data damping time. The lower the setting the faster the response to change.	0 to 59 seconds
[Heading]		
[Speed Through Water]		
[Wind Speed & Angle]		
[Rate of Turn]		
[Reset Default Page Settings]	Resets [Data Damping] menu settings to default.	

**[IF-NMEAFl Setup] section**

Menu item	Description	Options (setting range)
[Select IF]	Select [IF-NMEAFl] to set the analog data that is input from the IF-NMEAFl. The setting is made after restarting the IF-NMEAFl.	
[Category]	Select the use (category) for this sensor.	[Wind], [ST800_850], [Fuel], [FreshWater], [WasteWater], [LiveWell], [Oil], [BlackWater]

### 3. HOW TO SET UP THE EQUIPMENT

Menu item	Description	Options (setting range)
[Resistance Full]	The resistance, in Ohms, when the tank is full.	0 (ohm) to 500 (ohm)
[Resistance Mid]	The resistance, in Ohms, when the tank is half full.	0 (ohm) to 500 (ohm)
[Resistance Empty]	The resistance, in Ohms, when the tank is empty.	0 (ohm) to 500 (ohm)
[Capacity]	The capacity of the tank.	0 (G) to 2650 (G)
[Fluid Instance]	Select the NMEA instance for the tank.	000 to 254
[Self test]	Test results are displayed.	
[Set Hardware to Factory Default]	Resets the converter selected at [Select IF] to factory default.	[OK], [Cancel]

#### **[Fusion] section**

Menu item	Description	Options (setting range)
[Connect to Fusion]	Connects to your Fusion equipment.	
[Fusion Auto Volume]	Set to [On] to allow the TZT16X/22X/24X unit to control the FUSION volume automatically.	Off, On
[Minimum Speed]	Set the minimum speed threshold. Exceeding this speed activates volume auto control.	0.0 (kn) to 98.9 (kn)
[Maximum Speed]	Set the maximum speed threshold.	0.1 (kn) to 99.0 (kn)
[Volume Increase]	Set the amount of extra volume to output .	10% to 50%
[Reset Default Page Settings]	Resets [Fusion] menu settings to default.	

#### **[Service/Self Test/Log] section**

Menu item	Description	Option (setting range)
[Synchronization Log]	Shows synchronization with devices connected to the network.	
[Enable NMEA2000 Log]	Turn On when using NMEA 2000 log.	Off, On
[NMEA2000 Log Storage Location]	Show the location where to store the log.	
[Quick Self Test]	Displays various details regarding the TZT10X/13X unit, radar and fish finder.	
[Certification Mark]	Displays relevant certification for this equipment.	
[Service]	For the service technician.	
[Reset Default Page Settings]	Resets [Service/Self Test/Log] menu settings to default.	

#### **[Home Page] Section**

Menu item	Description	Options (setting range)
[Factory Reset]	Click [OK] to restore the [HOME] screen's default settings.	

#### **Other menu items**

Menu item	Description	Option (setting range)
[Chart Master Device]	Turn On to use this unit as the master, Off to use this unit as a slave.	
[System ID]	The system ID for this device within the network.	

Menu item	Description	Option (setting range)
[Event Input Configuration]	Set the function for the event switch. <ul style="list-style-type: none"> <li>• [Off]: Turns off the event switch function.</li> <li>• [Event Mark]: Inputs an event mark at the current position.</li> <li>• [MOB]: Inputs the MOB at the current position.</li> <li>• [Ferry mode (bow azimuth reversal)]: Turns ferry mode on or off.</li> </ul>	[OFF], [Event Mark], [MOB], [Ferry]
[Update Network Equipments]	For the service technician.	
[Remote Controller Configuration]	When there are multiple units in the NavNet network, the Remote Control Unit MCU-004/-005/-006 can select the display to show on the unit with MCU-004/-005/-006 connection. Further, the cycling order of displays can be set. See the Operator's Manual.	
[Sirius Radio Diagnostic]	Check the satellite radio of the FURUNO BBWX SiriusXM weather receiver for proper operation. See the Operator's Manual.	
[Sirius Weather Diagnostic]	Check the weather section of the FURUNO BBWX SiriusXM weather receiver for proper operation. See the Operator's Manual.	
[Reset Default Settings]	Reset the system to default settings.	[OK], [Cancel]

### **[Graphic Instruments Setup] section**

Menu Item	Description	Options (setting range)
[Maximum Boat Speed]	Set the transducer's maximum detectable speed.	1 (kn) to 99 (kn)
[Maximum Wind Speed]	Set the transducer's maximum detectable speed.	1 (kn) to 99 (kn)

### **[Graphic Instruments Setup] - [Depth]**

Menu Item	Description	Options (setting range)
[Minimum Depth]	Set the transducer's minimum detectable depth.	1 (m) to 1999 (m)
[Maximum Depth]	Set the transducer's maximum detectable depth.	1 (m) to 2000 (m)

### **[Graphic Instruments Setup] - [Sea Surface Temperature]**

Menu Item	Description	Options (setting range)
[Minimum Sea Surface Temperature]	Set the transducer's minimum detectable temperature.	0.00°C to 98.99°C
[Maximum Sea Surface Temperature]	Set the transducer's maximum detectable temperature.	0.01°C to 99.99°C

### **[Graphic Instruments Setup] - [Propulsion Engine] or [Other Engine]**

Menu Item	Description	Options (setting range)
[Max. RPM]	Set the maximum rpm of your engine to show on the RPM display.	1 (rpm) to 20,000 (rpm)
[Red Zone Oil Pressure]	Set the starting value for the red zone area of the oil pressure meter.	0 (psi) to 143 (psi)
[Max. Oil Pressure]	Set the maximum oil pressure of your engine.	1 (psi) to 144 (psi)

### 3. HOW TO SET UP THE EQUIPMENT

Menu Item	Description	Options (setting range)
[Min. Temperature]	Set the minimum temperature for your engine.	0.00°C to 99.00°C
[Red Zone Temperature]	Set the starting value for the red zone area of the engine temperature indicator.	0.01°C to 999.00°C

#### [Graphic Instruments Setup]-[CZone Setup]

Menu item	Description
[Add Default CZone Pages]	Create, edit C-Zone pages.
[CZone DIP Switch Settings]	Set this unit's DIP switches. For the service technician. Do not change the settings.

Menu item	Description	
[Reset Instrument Pages]	Resets all instrument pages to default.	[OK], [Cancel]
[Reset Default Page Settings]	Resets applicable settings to default.	[OK], [Cancel]

#### [Engine & Tank Automatic Setup] section

The TZT16X/22X/24X will automatically detect engines and tanks connected to the same network.

This is the recommended method for setting up engines and tanks.

#### [Engine & Tank Manual Setup] section

The manual set up method should only be used if the automatic setup did not correctly detect your engines or tanks.

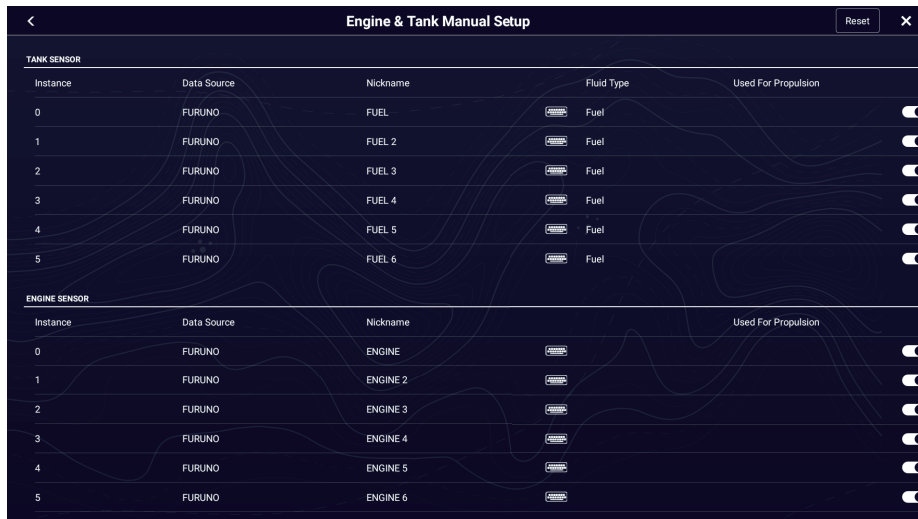

Menu Item	Description	Options (setting range)
[Nickname]	Change the nickname for the engine or tank.	
[Used For Propulsion]	Select which engine/tank is used to calculate the distance which may be traveled using the remaining fuel. [On] uses the engine/tank for calculations, [Off] ignores the engine/tank.	Off, On
[Reset]	Resets the engine/tank details to default.	



### 3.4 How to Set Up the Radar (For the service technician only)

1. Tap the **FURUNO** icon (  ) to show the home screen and display mode settings.
2. Tap [Radar] from the [Settings] menu.
3. Tap [User Settings]→ [Radar Source], then select the appropriate radar sensor.  
**Note:** If a DRS sensor is connected but does not appear in the [Radar Source] list, close the list and open it again. The name of the DRS sensor should appear with a check mark, as in the example below.

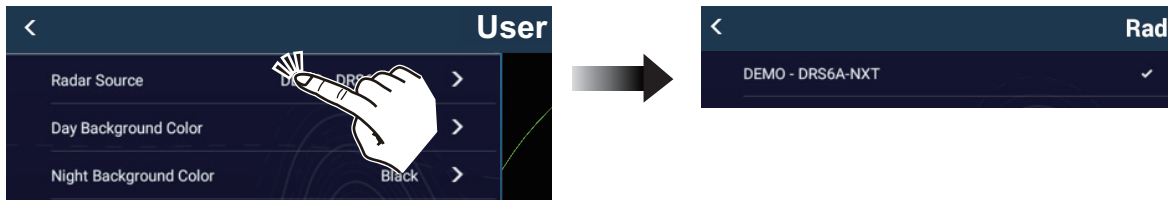

4. Scroll the [Radar] menu display to find the menu item [Radar Initial Setup], then tap [Radar Initial Setup].
5. Referring to the tables which follow, set up the radar.

**[Radar] menu - [Radar Initial Setup]**

Menu item	Description	Options (setting range)
[Antenna Rotation]	Select the speed of antenna rotation. Not available (greyed out) with the radar sensor DRS4DL+.	[Auto], [24 RPM]
[Antenna Heading Align]	See "How to align the antenna heading" on page 3-12.	-179.9° to +180.0°
[Main Bang Suppression]	If main bang appears at the screen center, slide the circle icon so that the main bang disappears, while watching the radar echo at the left-hand side of the display.	0 to 100
[Enable Sector Blanking]	Up to two sectors may be selected for blanking (no transmission). Select [ON] to enable this feature. Set the start and end angles (0° to 359°).	On, Off
[Enable Sector 2 Blanking]		
[Position from Bow]	Referring to the figure on the right, enter the radar antenna positioning bow-stern (Longitudinal) and port-starboard (Lateral) position from the origin. 	0 m to 999 m
[Position from Port]		-99 m to +99 m Port-side is negative, Starboard-side is positive.
[Height from Surface]	Select the height of the antenna above the waterline. Not available (greyed out) with the radar sensor DRS4DL+.	[Under 3m], [3m-10m], [Over 10m]
[Auto Tuning]	Enable/disable auto tuning for the connected radar. Not available (greyed out) with the radar sensor DRS2D-NXT, DRS4D-NXT.	Off, On
[Tuning Source]	Select a display in the dual range display to manually tune. Not available (greyed out) with the radar sensor DRS2D-NXT, DRS4D-NXT, DRS4DL+.	[Range1], [Range2]

### 3. HOW TO SET UP THE EQUIPMENT

Menu item	Description	Options (setting range)
[Manual Tuning]	Manually tune the radar.	-50 to 50
[Radar Monitoring]	Display various information regarding the connected radar.	
[Radar Optimization]	Automatically adjust magnetron output and tuning for the connected radar. Available when the [TX/STBY] setting is [ON]. Do not change these settings. Not available (greyed out) with the radar sensor DRS2D-NXT, DRS4D-NXT. <b>Note 1:</b> For the service technician only. <b>Note 2:</b> The service technician performs this whenever the magnetron is replaced.	
[ARPA Advanced Settings]	For service technician only. Do not change these settings. This item is available when [TX/STBY] is [ON]. Not available (greyed out) with the radar sensor DRS4DL+, and FAR-2xx8 series, FAR-2xx7 series and FAR-15x8 series radar antennas.	
[TX Channel]	Select [1], [2] or [3], the channel where the interference is smallest. See the operator's manual for details. Available with the radar sensor DRS2D-NXT, DRS4D-NXT.	[Auto], [1], [2], [3]
[Auto acquire by Doppler]	When selecting [ON], approaching targets (ships, rain clutter, etc.) within 3 NM from own ship are automatically acquired by the Doppler calculated from the radar echo. See the operator's manual for details. Available with the radar sensor DRS2D-NXT, DRS4D-NXT, DRS6A-NXT and DRS12A-NXT.	Off, On
[Set Hardware to Factory Default]	Resets the radar selected at [Radar Source] to factory default.	[OK], [Cancel]
[Reset Default Page Settings]	Resets [Radar] menu settings to default.	[OK], [Cancel]

#### How to align the antenna heading

You have mounted the antenna unit facing straight ahead in the direction of the bow. Therefore, a small but conspicuous target dead ahead visually should appear on the heading line (zero degrees).

In practice, you will probably observe some small bearing error on the display because of the difficulty in achieving accurate initial positioning of the antenna unit. The following adjustment will compensate for the error.

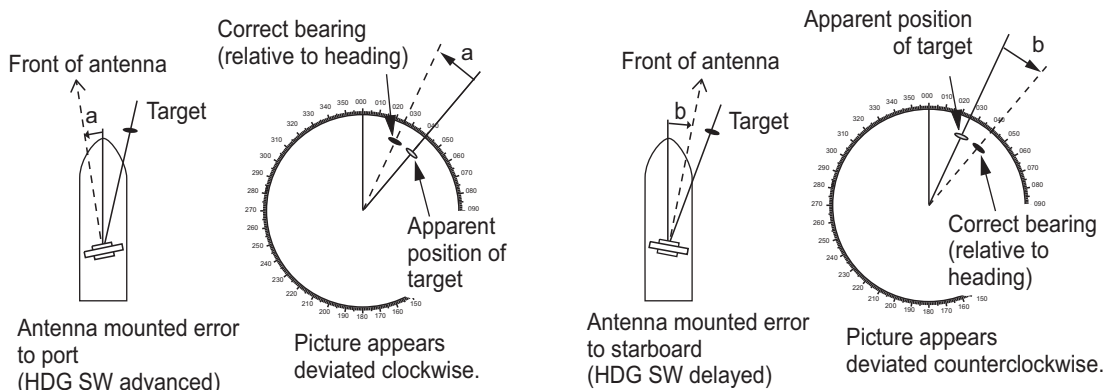

1. Set your radar with 0.125 and 0.25 nm range and the head up mode. You can select a range by using the pinch action. The range appears at the bottom right of the screen. Range may also be selected using the slide bar displayed on

the right-hand side of the radar display area. Drag the bar up to zoom in, or down to zoom out.

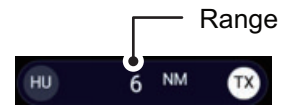
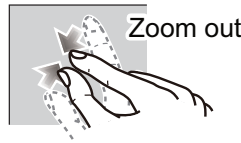
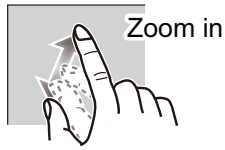

*Radar indications*

2. Turn the vessel's bow toward a target.
3. Tap the [Home] icon to show the home screen and display mode settings.
4. Tap [Radar] to show the [Radar] menu.
5. Tap [Radar Initial Setup] → [Antenna Heading Align].
6. Key in an offset value (setting range:  $-179.9^{\circ}$  to  $+180^{\circ}$ ) that puts the target at the very top of the screen, then tap the  icon.
  - + : rotate echo in clockwise direction
  - : rotate echo in counterclockwise direction
7. Confirm that the target echo is displayed at correct bearing on the screen.

### 3.5 How to Set Up the Fish Finder

When using the built-in fish finder of this unit or the NavNet TZtouch series unit in the same network, or connecting a network sounder (BBDS1 or DFF series), set up the sounder as shown in this section.

**Note 1:** Some menu items are restricted to certain external depth sounders and some menu items may not be available when using the internal depth sounder.

**Note 2:** For DFF-3D setup instructions, see the DFF-3D operator's manual.

1. Tap the **FURUNO** icon (  ) to show the home screen and display mode settings.
2. Tap [Settings], then tap [Fish Finder]
3. Refer to the table below to set up the fish finder.

**[Fish Finder Initial Setup] section**

Menu item	Description	Options (setting range)
[Transducer Setup]	Setup Transducer and Motion Sensor. See "[Transducer Setup] section" on page 3-16.	
[Preset Frequency Setup]	Set to change the TX center frequency and CHIRP width. Please refer to the instruction manual for details. <b>Note:</b> This menu is available when DFF3-UHD or TZT9F/12F/16F/19F is connected.	[Preset Frequency 1 Setup], [Preset Frequency 2 Setup], [Preset Frequency 3 Setup]

### 3. HOW TO SET UP THE EQUIPMENT

Menu item	Description	Options (setting range)
[Zero Line Rejection]	When you turn the zero line (transmission line) rejection on, the line is not shown, which allows you to see fish echoes near the surface. The width of the line changes with the transducer used and installation characteristics. If the width of the line is 1.4 m or more, select [ON]. <b>Note:</b> If [Fish Finder Source] is selected to TZTXFF (built-in fish finder for TZT16X), TZT12F/16F/19F (with DI-FFAMP), DFF3, or DFF-3 UHD, set [Zero Line Range] as described below.	Off, On
[Zero Line Range]	You can set the zero line removal range by turning on [Zero Line Rejection]. Available when [Fish Finder Source] is set to TZTXFF, DFF3-UHD, or DI-FFAMP and connected to a NavNet TZtouchXL. If the tail of the zero line is long, set a large value. If the zero line still does not disappear, reduce the transmission power. The default setting is 2.0.	DFF3: 1.4 to 2.5 Other than DFF3: 1.4 to 3.8
[Transducer Draft]	Set the distance between the transducer and the draft line to show the distance from the sea surface.	0.0m to 99.9m
[Salt Water]	Select [ON] if you use this equipment in salt water.	Off, On
[Fish Finder Source]	Set the fish finder to use. Select from a network fish finder (BBDS1, DFF1, DFF3, DFF1-UHD, DFF3-UHD), the built-in fish finder of this unit, or the NavNet TZtouch series unit in the same network. Setting options for this menu item depend on the equipment connected to this unit.	
[Transmission Format]	Select whether to transmit high and low frequencies simultaneously, or separately with a time delay. Normally, use [Parallel], which transmits the frequencies simultaneously. If you encounter interference near the bottom, select [Sequential A] or [Sequential B] in order to suppress the interference. <b>Note:</b> Shown with connection of DFF3-UHD.	[Parallel], [Sequential A], [Sequential B]
[Transmission Power Mode]	Set the TX power level. See the operator's manual for details.	DFF1-UHD: [Off], [Min], [Auto] DFF3-UHD: 0 to 10
[External KP]	Select on to synchronize with external sounder's keying pulse.	Off, On
[Bottom Level HF] [Bottom Level MF] [Bottom Level LF]	The default bottom level setting (0) determines that two strong echoes received in sequence are bottom echoes. If the depth indication is not stable in the default setting, adjust the bottom level here. If vertical lines appear from the bottom echo in the bottom lock display, lower the bottom level to erase the vertical lines. If you can not identify the fish near the bottom from the bottom echo, increase the bottom level.	-40 to +40
[Gain Offset HF] [Gain Offset MF] [Gain Offset LF]	If the auto gain offset is wrong, or there is a difference in the gain between the low and high frequencies, set an offset here to balance auto gain for the two frequencies.	-50 to +50
[Auto Gain Offset HF] [Auto Gain Offset MF] [Auto Gain Offset LF]	If the auto gain offset is wrong, or there is a difference in the gain between the low and high frequencies, set an offset here to balance auto gain for the two frequencies.	-5 to +5

Menu item	Description	Options (setting range)
[STC HF] [STC MF] [STC LF]	Adjust the low (LF), middle (MF) or high (HF) STC frequency. See the operator's manual for details. <b>Note:</b> Shown with connection of DFF3, DFF1-UHD or DFF3-UHD.	0 to +10
[TX Pulse HF] [TX Pulse MF] [TX Pulse LF]	The pulse length is automatically set according to range and shift, however it can also be set manually. Use a short pulse for better resolution and a long pulse when detection range is important. To improve resolution on zoom displays, use [Short 1] or [Short 2]. <ul style="list-style-type: none"> <li>• [Short 1] improves the detection resolution, but the detection range is shorter than with [Std] (pulse length is 1/4 of [Std]).</li> <li>• [Short 2] raises the detection resolution, however detection range is shorter (pulse length is about 1/2 of [Std]) than [Std].</li> <li>• [Std] is the standard pulse length, and is suitable for general use.</li> <li>• [Long] increases the detection range but lowers the resolution (about 1/2 compared to the [Std] pulse length)</li> </ul> <b>Note:</b> Shown with connection of DFF3 or DFF3-UHD connected to a narrow band width transducer.	[Short1], [Short2], [Standard], [Long]
[RX Band HF] [RX Band MF] [RX Band LF]	Set the bandwidth for low (LF) or high (HF) frequency. The RX bandwidth is automatically set according to pulse length. To decrease noise, select [Narrow]. For better resolution, select [Wide]. <b>Note:</b> Shown with connection of DFF3, DFF3-UHD.	[Narrow], [Standard], [Wide]
[Temperature Port]	Set the data source for water temperature. <ul style="list-style-type: none"> <li>• [MJ]: Use the temperature/speed sensor for data.</li> <li>• [Low Frequency]: Use the LF sensor for data.</li> <li>• [High Frequency]: Use the HF sensor for data.</li> </ul> <b>Note:</b> Shown with connection of DFF3, DFF1-UHD.	[MJ], [Low Frequency], [High Frequency]
[Fish Finder Demo Mode]	The demo mode provides simulated operation using data stored in the internal memory. <ul style="list-style-type: none"> <li>• [Off]: Disable the demo mode.</li> <li>• [Shallow]: Enable shallow water demo mode.</li> <li>• [Deep]: Enable deep water demo mode.</li> </ul> <b>Note:</b> Shown with connection of BBDS1, DFF1, DFF3, DFF1-UHD or DFF3-UHD.	[Off], [Shallow], [Deep]
[Set Hardware to Factory Default]	Reset the external fish finder to its factory default settings.	[OK], [Cancel]
[Restore Default Page Settings]	Restore all menu settings to default.	[OK], [Cancel]

### 3. HOW TO SET UP THE EQUIPMENT

#### **[Transducer Setup] section**

For motion sensor related settings, see "Motion sensor menu" on page 3-18.  
From [High Frequency Min] to [Low Frequency Max] is shown only when DFF3-UHD is connected.

**Note:** Make sure that the unit is set to stand-by when setting up the transducer.

Menu item	Description	Options (setting range)
[Transducer Setup Type]	Select the type of transducer connected. When the connected sounder is a DFF1-UHD and the transducer has a compatible TDID, [TDID] is automatically selected. <b>Note:</b> When the transducer model is changed or TDID is detected, the frequency and bandwidth set on [Manual] is to be reset. <ul style="list-style-type: none"> <li>• [Manual]: Manually set up the transducer.</li> <li>• [Model]: Select the appropriate transducer model (for FURUNO or AIRMAR transducers).</li> </ul>	[Manual], [Model]
[Model Number]	Select the appropriate model number from the list. <b>Note:</b> Only available when [Transducer Setup Type] is set to [Model].	
[High Frequency Min]	Display the high frequency minimum.*	
[High Frequency Max]	Display the high frequency maximum.*	
[Low Frequency Min]	Display the low frequency minimum.*	
[Low Frequency Max]	Display the low frequency maximum.*	
[Reset Default Page Settings]	Reset the [Transducer Setup] menu settings to default.	[OK], [Cancel]

\*: Shown with connection of DFF3.

#### **When [Transducer Setup Type] is set to [Model] and connected to DFF3**

Menu item	Description
[High Frequency]	Set the frequency (kHz) of the connected high frequency transducer.
[Frequency Adjust HF]	Fine-tune the high-frequency TX frequency to eliminate interference (setting range: -50 to +50). Set to [0] where there is no interference.
[Low Frequency]	Set the frequency (kHz) of the connected low frequency transducer.
[Frequency Adjust LF]	Fine-tune the low frequency TX frequency to eliminate interference (setting range: -50 to +50). Set to [0] where there is no interference.

#### **When [Transducer Setup Type] is set to [Model] and connected to DFF3-UHD**

Menu item	Description	Options (setting range)
[TX Mode HF]	Band adjustment mode for center frequency and CHIRP frequency of the transducer connected to the high frequency side.	[Auto CHIRP], [FM (Manual CHIRP)] <sup>*1</sup> , [CW (Fixed Frequency)] <sup>*2</sup>
[High Frequency]	Set the high frequency (kHz) of the transducer connected to the high frequency side.	
[Frequency Adjust HF]	If <sup>*1</sup> or <sup>*2</sup> is selected at [TX Mode HF], fine-tune the high-frequency TX frequency to eliminate interference (setting range: -50 to +50). Set to [0] where there is no interference.	
[CHIRP Width HF]	If <sup>*1</sup> is selected in [TX Mode HF], set the CHIRP frequency band of the transducer connected to the high frequency side.	

Menu item	Description	Options (setting range)
[TX Mode LF]	Band adjustment mode for center frequency and CHIRP frequency of the transducer connected to the low frequency side.	[Auto CHIRP], [FM (Manual CHIRP)] <sup>*1</sup> , [CW (Fixed Frequency)] <sup>*2</sup>
[Low Frequency]	Set the low frequency (kHz) of the transducer connected to the low frequency side.	
[Frequency Adjust LF]	If <sup>*1</sup> or <sup>*2</sup> is selected at [TX Mode LF], fine-tune the low-frequency TX frequency to eliminate interference (setting range: -50 to +50). Set to [0] where there is no interference.	
[CHIRP Width LF]	If <sup>*1</sup> is selected in [TX Mode LF], set the CHIRP frequency band of the transducer connected to the low frequency side.	

*When [Transducer Setup Type] is set to [Manual]*

Menu item	Description	Options (setting range)
[High Frequency]	Set the kHz frequency for high frequency. Setting ranges vary depending on the transducer connected. <b>Note:</b> Shown with connection of DFF1, BBDS1, DFF3, DFF1-UHD.	
[Transducer Power HF]	Set the transmission power for high frequency. <b>Note 1:</b> Shown with connection of DFF1, BBDS1, DI-FFAMP or DFF3-UHD. <b>Note 2:</b> For DFF1-UHD users, when the connected transducer TDID is not supported by the DFF1-UHD, the setting is fixed as [1000].	[600], [1000]
[Band Width (HF)]	Set the bandwidth for high frequency. <b>Note:</b> Shown with connection of DFF3.	
[Low Frequency]	Set the kHz frequency for low frequency. Setting ranges vary depending on the transducer connected. <b>Note:</b> Shown with connection of DFF1, BBDS1, DFF3, DFF1-UHD.	
[Transducer Power LF]	Set the transmission power for low frequency. <b>Note 1:</b> Shown with connection of internal fish finder, DFF1, BBDS1, DI-FFAMP and DFF3-UHD. <b>Note 2:</b> For DFF1-UHD users, when the connected transducer TDID is not supported by the DFF1-UHD, the setting is fixed as [1000].	[600], [1000]
[Band Width (LF)]	Set the bandwidth for low frequency. <b>Note:</b> Shown with connection of DFF3.	

*When [Transducer Setup Type] is set to [Manual] and connected to DFF3-UHD*

Menu item	Description
[TX Volt HF]	Set the TX voltage (V) of the transducer connected to the high frequency side.
[TX Volt LF]	Set the TX voltage (V) of the transducer connected to the low frequency side.
[High Frequency]	Set the frequency (kHz) of the transducer connected to the high frequency side.
[Low Frequency]	Set the frequency (kHz) of the transducer connected to the low frequency side.
[TX Power HF]	Set the Power of the transducer connected to the high frequency side.
[TX Power LF]	Set the Power of the transducer connected to the low frequency side.

### 3. HOW TO SET UP THE EQUIPMENT

#### Motion sensor menu

The [Motion Sensor] menu sets up the motion sensor, which provides for stable display of the seabed, schools of fish, etc. in moderate-to-rough seas.

**Note 1:** For connection of NMEA0183 equipment to the TZT16X/22X/24X, ask your FURUNO dealer to set up the equipment.

**Note 2:** To use the heaving function, the following settings are required at the satellite compass. For the setting procedure, see the operator's manual for your satellite compass. Settings for SC-30 are done from the [IF-NMEASC] menu, settings for SCX-20 is done from the [DATA OUT] menu.

	NMEA0183	NMEA 2000
Sentence	ATT, HVE	–
Baud rate	38400BPS	–
Cycle	25ms	–
PGN	–	Heave: 65280 Attitude: 127257

The [MOTION SENSOR] menu appears in the [Transducer Setup] menu when the [Heaving Correction] is activated in the [Fish Finder] menu. If the satellite compass SC-30 or SC50/110 is connected, set the distance between the antenna unit (or sensor) of the satellite compass and transducer (high and low if connected) here.

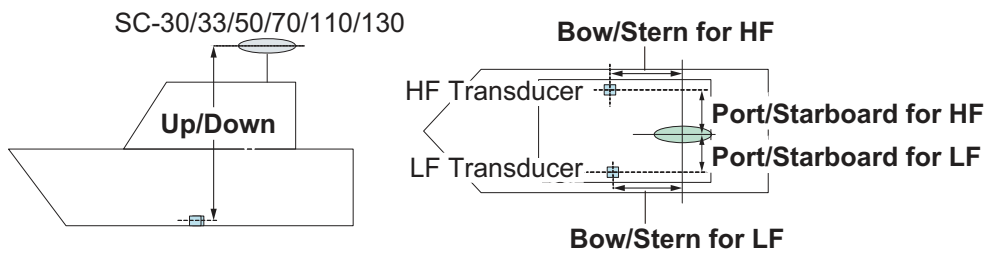

Menu item	Description	Options (setting range)
[Motion Sensor Type]	Select the sensor connected to your TZT16X/22X/24X unit. For all sensors other than SC-50 and SC-110, select [SC-30]. <b>Note:</b> This menu item is not available when [Fish Finder Source] is set to [TZT16X/22X/24X].	[SC30], [SC50_SC110]
[Antenna Position Bow/Stern HF (LF)]	Set the distance from the antenna unit to the transducer in the bow-stern direction. If the transducer is located on the fore side, set a positive value.	-99 to +99
[Antenna Position Up/Down HF (LF)]	Set the distance from the transducer to the antenna unit in the vertical direction. If the transducer is located on the bow side, set a positive value.	-0.00 to +99.9
[Antenna Port/Starboard HF (LF)]	Set the distance from the antenna unit to the transducer in the port-starboard direction. If the transducer is located on the starboard side, set a positive value.	-99.9 to +99.9

#### Transducer mis-mount correction

If the DFF-3D or a CHIRP side scan compatible transducer is installed 180° in reverse (facing stern), turn on the following item:

- DFF-3D: [Settings]→[Multi Beam Sonar]→[Initial Setup]→[Transducer Setup]→[Transducer Mis-mount Correction]→[ON]



- CHIRP Side Scan: [Settings]→[CHIRP Side Scan]→[Transducer Mis-mount Correction]→[ON]

## 3.6 Wireless LAN Setting

### 3.6.1 How to join an existing wireless network

By connecting to an existing network, you may download software updates and weather information from the Internet.

1. Tap the **FURUNO** icon (  ) to show the home screen and display mode settings.
2. Tap [Settings], then [General].
3. Tap [Connectivity], then [Wireless LAN Settings].
4. Tap [Wireless Mode].
5. Tap [Connect to existing LAN], then tap the [<] icon at the top left of the display.
6. Turn on [Wireless] in the [ENABLE WIRELESS] menu.
7. Tap [Scan] to scan the vicinity for accessible WLAN networks. Available networks are listed. To delete all WLAN networks, select [Forget All Available Networks].
8. Tap the appropriate WLAN network to show the following display.

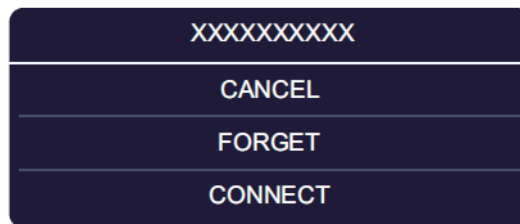

9. Tap [Connect], and the display shown in the right figure appears.
10. Use the software keyboard to enter the network key, then tap the [OK] button. To see what you have input, check [Show characters].

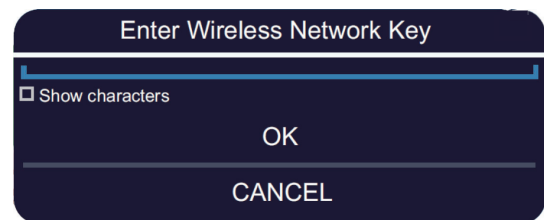

**Note:** If the network key is incorrect, an error message appears. Enter the correct key and tap [OK] again.

11. Tap [x] on the title bar to close the menu.

### 3.6.2 How to create a wireless LAN network

Smart devices connected to this wireless network may also connect directly to the unit, allowing use of the TZT16X/22X/24X applications.

1. Tap the **FURUNO** icon (  ) to show the home screen and display mode settings.
2. Tap [Settings] then [General], in that order.
3. Tap [Connectivity], then [Wireless LAN Settings].

### 3. HOW TO SET UP THE EQUIPMENT

4. Tap [Wireless Mode] in the [WIRELESS MODE] menu.
5. Tap [Create Local Network], then tap the [<] icon at the top left of the display.
6. Tap [Name] in the [LOCAL NETWORK SETTINGS] menu.
7. Using the software keyboard, name the unit, then tap the ✓.
8. Tap [Password] in the [LOCAL NETWORK SETTINGS] menu.
9. Using the software keyboard, set the password, then tap the ✓.
10. Tap [Local Network] in the [ENABLE LOCAL NETWORK] menu to activate the wireless network.
11. Your smart device may now be connected to the unit, through the network.
  - 1) From the smart device, select the network set at step 7.
  - 2) Input the password set at step 9.
12. Tap [x] on the title bar to close the menu.

## 3.7 Ferry Mode

**Note:** Only the SC-30, SC-33, and SCX-20 support the Ferry Mode.

Ferry mode allows the user to change the screen orientation by 180°. Note that all the above heading sensors must support heading offset command from the TZT16X/22X/24X. Both heading sensors and radar sensors must be powered on when the TZT16X/22X/24X sends the command. Both the heading sensor and radar sensor must be powered when the TZT16X/22X/24X sends the heading offset command to them. If TZT16X/22X/24X sends the command and one of the sensors does not receive it, the heading data may be reversed. See "[Event Input Configuration]" on page 3-9.

## 3.8 How to Manage Your Charts

A TZ MAPS world chart is provided standard. For all other TZ MAPS charts you will need to purchase and load a chart license together with an unlock code. (The same applies to MM3D charts.) To share the system ID and unlock code between NavNet TZtouch series units connected within the same network, go the Home page on any unit → [Settings] → [Initial Setup] → turn on [Chart Master].

**Note:** If two or more NavNet TZtouch series devices share an unlock code, it is necessary to obtain a new unlock code when changing the Chart Master settings. For example, one unit is set as "main" (Chart master setting: ON) and the other unit as "secondary" (Chart master setting: OFF), you need to reacquire an unlock code.

### 3.8.1 How to update or add TZ MAPS charts

By connecting this device to the Internet and logging into My TIMEZERO™, you can purchase and renew a TZ MAPS chart license (valid for one year) and download chart data online. Downloaded chart data can be used even when offline by putting it on a microSD card and inserting it into the card slot on the back of the device.

**Note:** Chart licenses are valid for one year, and during this period charts can be downloaded and updated. After the license period expires, you can continue to use the already downloaded charts. However, charts cannot be downloaded or updated. After

the one-year period, you can purchase a new chart license, which will be automatically renewed yearly. To cancel the automatic renewal, go to your My TIMEZERO™ account, using the link below. The automatic renewal cannot be canceled from the device side.

<https://extranet.mytimezero.com/>

1. Home page→[Charts]→[TZ MAPS Store].

Tap here to highlight the selected area, on the right side of the screen (White background: Not purchased, Blue background: Purchased).

[Buy]: Not purchased, [ ✓ ]: Purchased

\*: When the license expires (one year), the indication changes to [Subscribe], and when you select and purchase a subscription, the indication changes to [Subscribed].

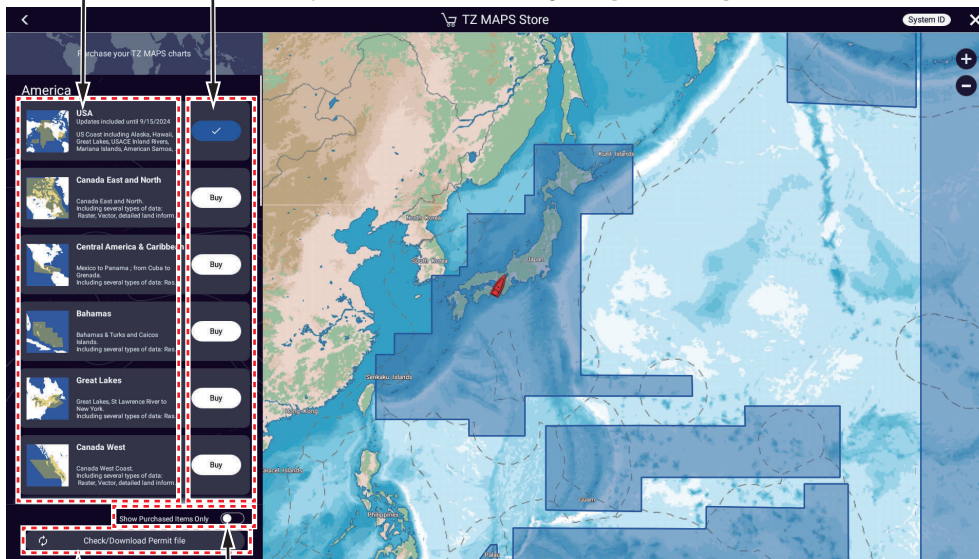

Turn ON to display only purchased charts.

Tap to check whether there is a license for the purchased chart. If there is, the file will be downloaded. After downloading, the [Buy] button of the purchased chart changes to a blue button with a checkmark, and you can then download the chart data for the purchased area ✓.

2. Tap the [Buy] button corresponding to the area to purchase. The message "Please wait, preparing your purchase" appears then the "buy screen" appears.

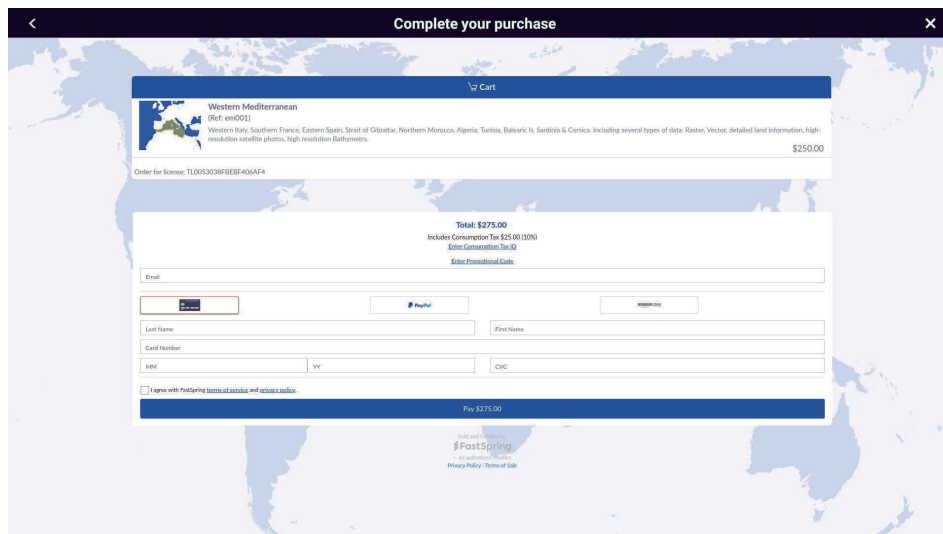

### 3. HOW TO SET UP THE EQUIPMENT

If you are not connected to the Internet, a quick-response code appears. Use your smartphone/tablet to read it and display the “buy screen”.

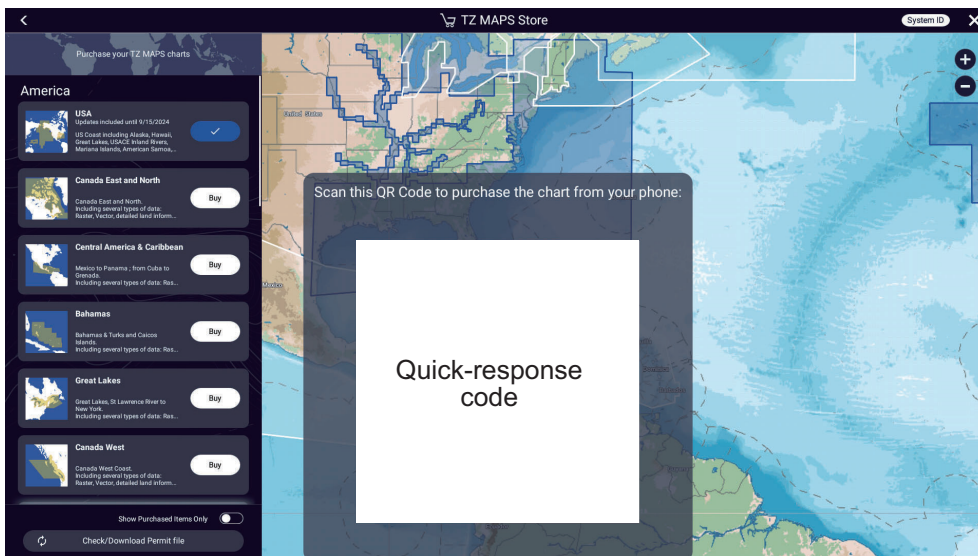

3. Select how to buy the chart.
4. Enter the required information.
5. Read the conditions of purchase, check ✓ to agree, then tap [Payment].
6. If you purchase a license using a quick-response code, a ZUC file is sent to your registered email address. Save the file to a USB flash memory, insert the memory into the USB port of this equipment, and read the file.

### 3.8.2 How to update TZ MAPS charts

If there is a new version of a downloaded chart data, there are two ways to update the chart, individually or all at once.

1. Home page→[Charts]→[TZ MAPS Update].

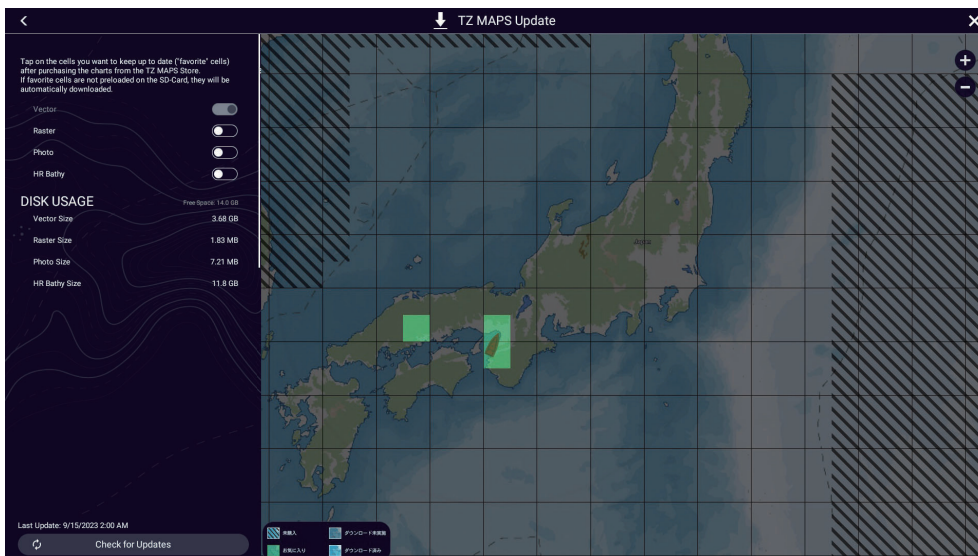

2. Update chart data collectively: Tap [Check for Updates], at the bottom left corner of the screen,  
Update chart data individually: Tap the area you want to update.

### 3. HOW TO SET UP THE EQUIPMENT

The update begins and progress is indicated at the bottom left corner of the screen. The [Check for Updates] button label changes to [Cancel], and when the update is completed it changes to [Download Updates].

For individual download, the selected area is given [Favorites]\* status, Tap [×] on the title bar to close the T[TZ MAPS Update] screen and complete the process.

For collective download, an icon appears in the areas that can be updated. You can update multiple areas. The following screen appears.

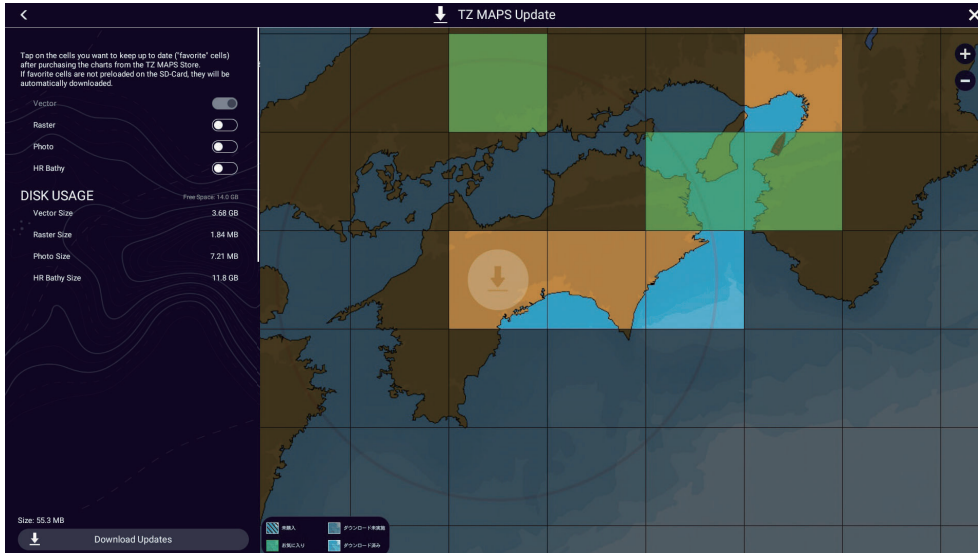

\*: Depending on the status of chart data, each area is classified and displayed into the following four types. Areas set as [Favorites] are automatically updated if the latest data is available. [Favorites] switches between [Favorites] and [Downloaded] each time you tap an area.

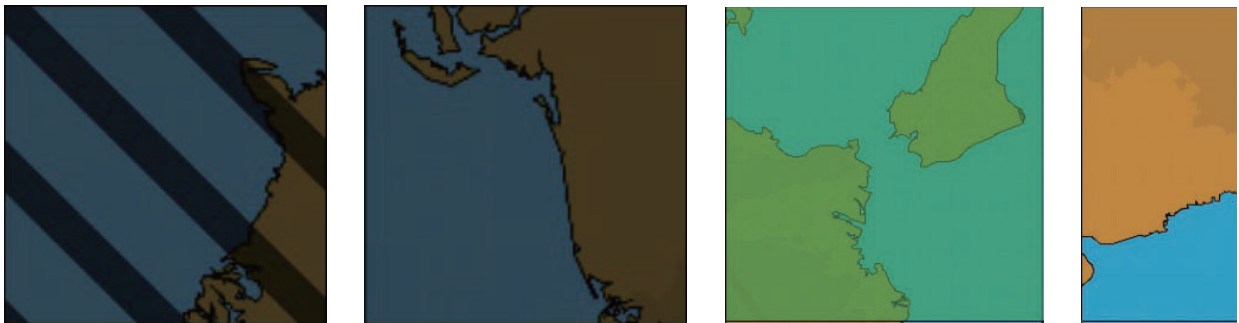

3. Tap [Download Updates] at the bottom left corner of the screen. The download begins and progress is indicated at the bottom left corner of the screen. The [Download Updates] button label changes to [Cancel] and then [Downloaded] once the download is complete.
4. Tap [×] on the title bar to finish the download and close the [TZ MAPS Update] screen.



3. HOW TO SET UP THE EQUIPMENT

### 3.8.3 How to display the MM3D charts catalog

The charts catalog shows all the charts incorporated in your equipment. To show the charts catalog, Home page→[Charts]→[MM3D Charts Catalog].

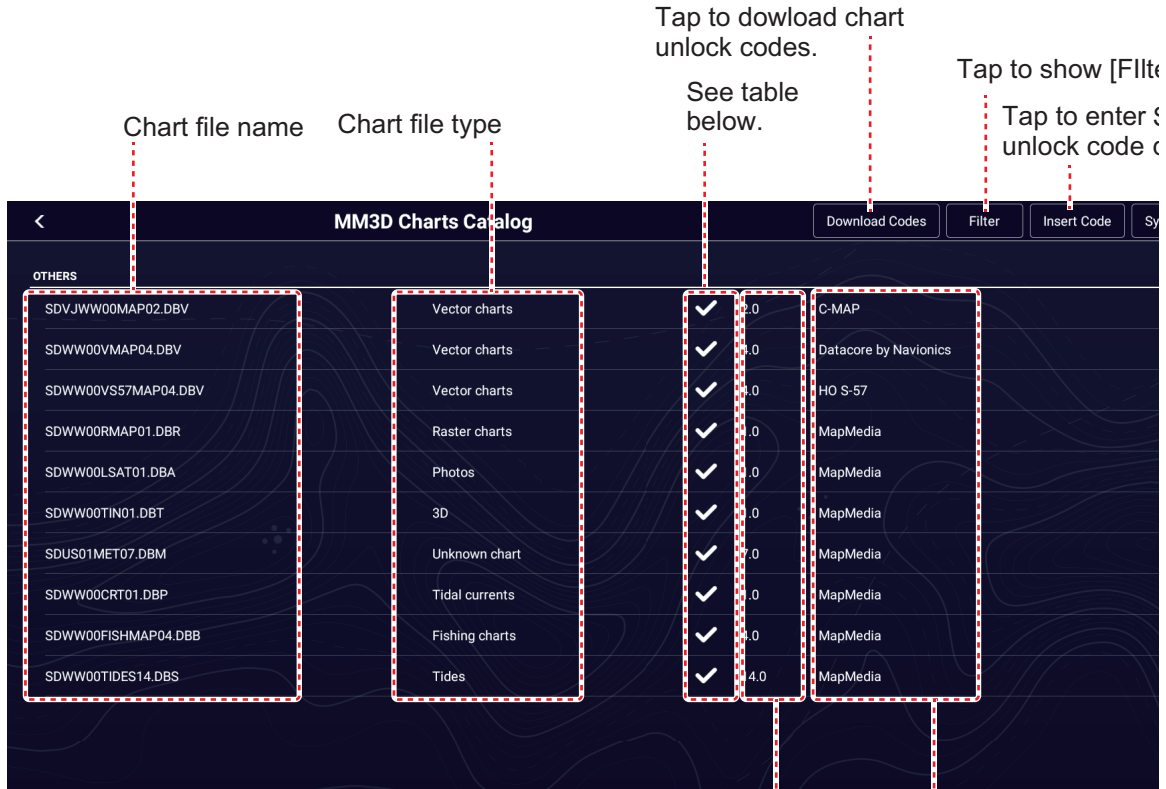



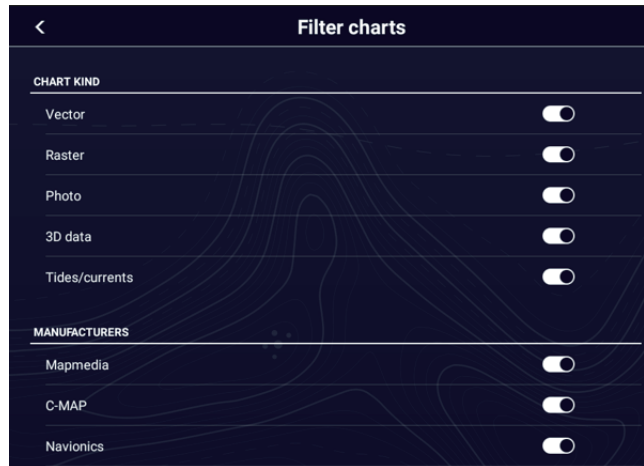

Chart status icon	Meaning	Chart status icon	Meaning
	Free chart. An unlock code is not necessary.		Paid chart. Unlock code entered.
	Paid chart. Unlock code is necessary to use the chart. Tap [Insert Code] at the top of the [Charts Catalog] screen. Enter the unlock code then tap [✓] to finish.		Chart cannot be used because it is corrupted.

### **How to hide unnecessary charts on the chart catalog list**

1. Tap [Filter] on the chart catalog list title bar to show the [Filter charts] window.
2. Select [OFF] for the items that you want to hide. The factory setting shows all charts. To restore all charts, tap [Reset Filters].
3. Tap < on the title bar to return to the chart catalog list. [Filter] on the title bar changes to [Change Filter].
4. Tap the close button to close the chart catalog list.



### **3.8.4 How to add MM3D charts**

For information on how to obtain a chart and the unlock code, contact the point of purchase, or the nearest branch/sales office of our company. Copy the chart to a microSD card and insert it into the card slot on the back of the equipment. If you have added a paid chart, please enter the unlock code (see the section 3.8.3).

### **3.8.5 How to MM3D charts**

To delete charts, go the Home page then tap [Charts]→[MM3D Chart Catalog]. Tap the trash can icon (right edge of screen) corresponding to the chart to delete. You are asked if you are sure to delete the chart. Tap [OK] to delete the chart.

## **3.9 IP Camera Setup**

When connecting one or more IP camera (maximum 8), the following settings are required at the camera.

- IP Address: 172.31.xxx.xxx
- Subnet Mask: 255.255.0.0

### 3. HOW TO SET UP THE EQUIPMENT

This page is intentionally left blank.



# APPX. 1 TRANSDUCER INSTALLATION GUIDE

## OWNER'S GUIDE & INSTALLATION INSTRUCTIONS

Transom Mount  
Side Scan Transducer

Model: **TM904**

Record the information found on the cable tag for future reference.

Part No: \_\_\_\_\_ Serial No: \_\_\_\_\_  
Date \_\_\_\_\_ Frequency \_\_\_\_\_ kHz

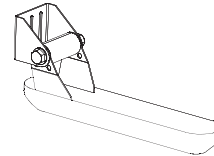

09/28/22

102642-rev.1

D-201960-rev.1

**Follow the precautions below for optimal product performance and to reduce the risk of property damage, personal injury, and/or death.**

**WARNING:** Always wear safety glasses, a dust mask, and ear protection when installing.

**WARNING:** When the boat is placed in the water, immediately check for leaks around the screws and any other holes drilled in the hull.

**CAUTION:** Never pull, carry, or hold the sensor by the cable as this may sever internal connections.

**CAUTION:** Never strike the transducer with anything except the palm of the hand. Never strike the paddlewheel.

**CAUTION:** Never use solvents. Cleaner, fuel, sealant, paint and other products may contain solvents that can damage plastic parts, especially the transducer's face.

**IMPORTANT:** Please read the instructions completely before proceeding with the installation. These instructions supersede any other instructions in your instrument manual if they differ.

### Mounting Location

**CAUTION:** Do not mount the sensor in line with or near water intake or discharge openings; or behind strakes, struts, fittings, or hull irregularities that will disturb the water flow.

**CAUTION:** Do not mount the sensor in a location where the boat may be supported during trailering, launching, hauling, or storage.

- For the best performance, the sensor must be in contact with smooth water. To identify an area of "clean" water, observe the water flow off the transom while the boat is underway.
- Mounting the sensor on the side of the transom where the propeller blades are moving downward is preferred (Figure 1).
- Mount the sensor as close to the centerline (keel) of the boat as possible to ensure the transducer's face remains in the water when the boat is turning.

### Applications

- Not recommended for boats with inboard engine(s).
- Not recommended for a stepped hull
- Adjusts to *transom* angles from 0°–30°
- Vertically orients sound beam on hull with *deadrise* angle up to 28°
- Recommended for boats capable of speeds up to 30kn (35MPH). Optimal speed is 1.5 - 8.5 kn (2 - 10MPH).

### Boat Types

- **Single drive boat**—Mount a minimum of 15cm (6") beyond the swing radius of the propeller (Figure 1).
- **Twin drive boat**—Mount between the drives a minimum of 15cm (6") beyond the swing radius of the propeller.
- **Trim tabs**—Mount inside the trim tab, space permitting.
- **Stepped transom**—Mount the transducer on the lowest step.

### Tools & Materials

- Safety glasses
- Dust mask
- Ear protection
- Pencil
- Electric drill
- Drill bits and hole saws:
  - Bracket holes 5mm, #4, or 7/32"
  - Transom hole (optional) 2mm or 1/16" larger than connector Ø
  - Cable clamp holes 3mm or 1/8"
- Masking tape
- Angle finder
- Grommets (some installations)
- Marine sealant (suitable for below waterline)
- Socket wrench
- Torque wrench
- Screwdrivers
- Straight edge
- Cable ties
- Water-based anti-fouling paint (**mandatory in salt water**)

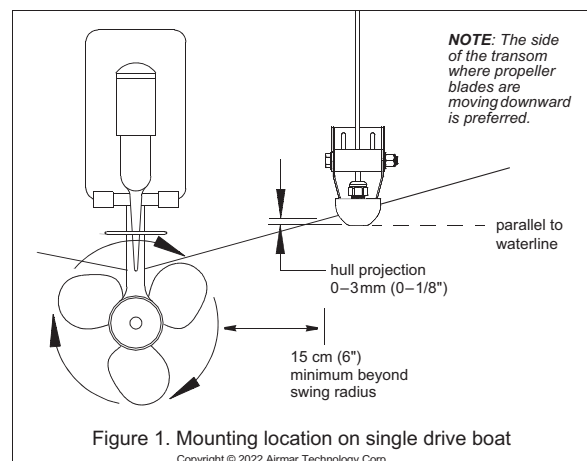

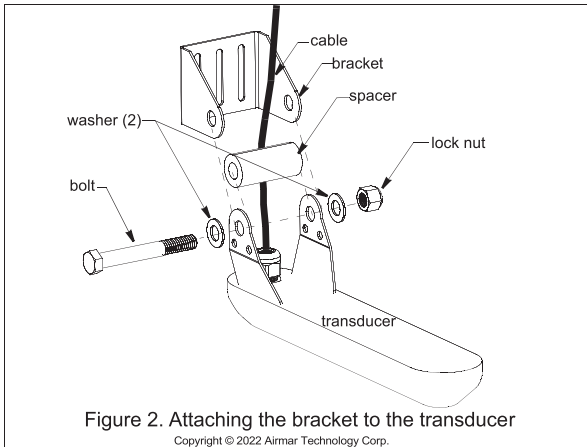

Figure 2. Attaching the bracket to the transducer  
Copyright © 2022 Airmar Technology Corp.

**Installation**

**Attaching the Bracket to the Transducer**

1. Slide a washer onto the bolt (Figure 2).
2. Align the bracket to the transducer and insert the bolt through the upper hole in the transducer. Slide the spacer onto the bolt and push the bolt through the remaining hole in the transducer and the bracket. Ensure the cable passes between the bracket and the spacer.
3. Slide the remaining washer onto the bolt and hand tighten the lock nut onto the bolt.

**Hole Drilling**

**CAUTION:** To prevent drilling too deeply, wrap masking tape around the bit 22mm (7/8") from the point.

**NOTE: Fiberglass hull—**Minimize surface cracking by running the drill in reverse until the gelcoat is penetrated.

1. At the selected location position the transducer, so it projects 3mm (1/8") below the bottom edge of the transom (Figure 1).
2. Be sure the bottom of the transducer is parallel to the waterline.
3. Mark the screw holes with an "X" in the center of each slot in the bracket.
4. Using a 5mm, #4, or 7/32" drill bit, drill three holes 22mm (7/8") deep at the marked locations.

**Mounting the Bracket**

**CAUTION: Metal hull—**The stainless steel bracket must be isolated from a metal hull to prevent electrolytic corrosion. Place non-metal insulating washers between the bracket and the metal hull.

1. Remove the bracket from the transducer.
2. Apply marine sealant to the threads of the three hex-washer-head screws to prevent water seepage into the transom. Screw the bracket to the hull using a socket wrench. *Do not tighten the screws at this time.*
3. Reinstall the transducer to the bracket (Figure 2).

**Checking the Sensor Angle & Projection**

**CAUTION:** Do not position the leading edge of the sensor deeper in the water than the trailing edge because aeration will occur.

**CAUTION:** Do not position the sensor deeper into the water than necessary to avoid increasing drag, spray, and water noise and reducing boat speed.

1. Using the vertical adjustment space in the bracket slots, slide the assembly up or down until the bottom inside corner of the transducer projects 0–3mm (0–1/8") below the bottom of the hull (Figure 1). When you are satisfied with the position of the transducer, tighten the three bracket screws. For clear access to the screws, remove the transducer assembly from the bracket (Figure 2). *When reattaching, be sure to include the spacer.*
2. With the transducer in the operational position, use a straight edge to sight the underside of the transducer relative to the underside of the hull (Figure 3). The trailing edge of the transducer should be 1–6mm (1/16–1/4") below the leading edge. When you are satisfied with the position of the transducer, use a torque wrench to tighten the lock nut to 40ft lbs.

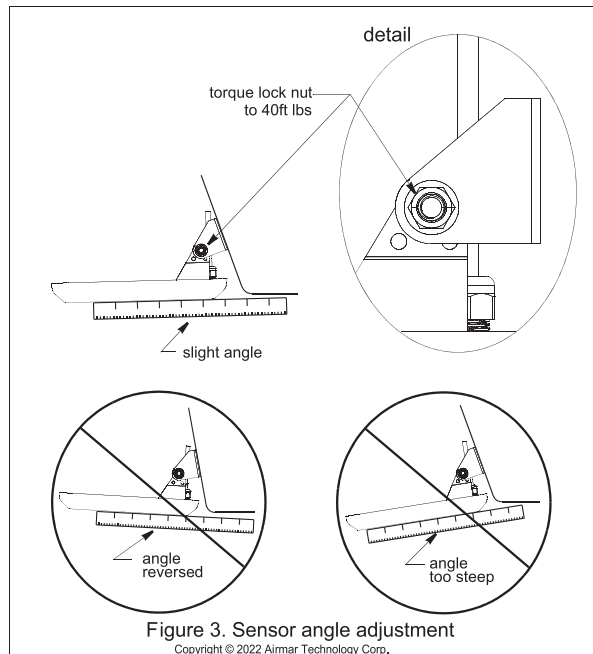

Figure 3. Sensor angle adjustment  
Copyright © 2022 Airmar Technology Corp.

**Testing on the Water**

1. Become familiar with your echosounder's performance at a speed of 4 kn (5MPH).
2. Gradually increase the boat speed and observe the gradual decline in performance due to turbulent water flowing under the transducer's face.
3. If the decline in performance is sudden (not gradual), identify the boat speed at which the onset occurred. Return the boat to this speed, then gradually increase speed while making moderate turns in both directions.
4. If the performance improves while turning to the side on which the sensor is installed, the transducer's position probably needs adjustment. The transducer is probably in turbulent or aerated water.

**To improve performance**, try the following one at a time in the order given, in small increments.

- a. Increase the sensor's angle in the water. Review "Checking the Sensor Angle & Projection:" and see Figure 3.
- b. Move the sensor deeper into the water in increments of 3mm (1/8") (Figure 4).
- c. Move the sensor closer to the centerline of the boat. Fill unused screw holes with marine sealant.

**NOTE:** Optimal operating speed for a side scan transducer is 1.5 - 8.5 kn (2 - 10MPH).

**Cable Routing & Connecting**

**CAUTION:** Do not remove the connector to ease cable routing. If the cable must be cut and spliced, use Airmar's splash-proof Junction Box No. 33-035 and follow the instructions provided. Removing the waterproof connector or cutting the cable, except when using a water-tight junction box, will void the sensor warranty.

Route the sensor cable over the transom, through a drain hole, or through a new hole drilled in the transom **above the waterline**.

1. If a hole must be drilled through the transom, choose a location **well above the waterline** (Figure 4). Check for obstructions such as trim tabs, pumps, or wiring inside the hull. Mark the location with a pencil. Drill a hole using the appropriate size bit to accommodate the connector.
2. Route the cable over or through the transom.
3. On the outside of the hull, secure the cable against the transom using the cable clamps. Position a cable clamp 15cm (6") above the bracket and mark the mounting hole with a pencil.
4. Position the second cable clamp halfway between the first clamp and the cable hole. Mark this mounting hole.
5. If a hole has been drilled in the transom, open the appropriate slot in the cable cover. Position the cover over the cable where it enters the hull. Mark the two mounting holes.
6. At each of the marked locations, use a 3mm or 1/8" bit to drill a hole 10mm (3/8") deep.
7. Apply marine sealant to the threads of the #6 x 1/2" self-tapping screws to prevent water from seeping into the transom. If you have drilled a hole through the transom, apply marine sealant to the space around the cable where it passes through the transom.

8. Position the two cable clamps and fasten them in place. If used, push the cable cover over the cable and screw it in place.
9. Route the cable to the instrument being careful not to tear the cable jacket when passing it through the bulkhead(s) and other parts of the boat. Use grommets to prevent chaffing. To reduce electrical interference, separate the sensor cable from other electrical wiring and the engine(s). Coil any excess cable and secure it in place with cable ties to prevent damage.
10. Refer to your echosounder owner's manual to connect the sensor to the instrument.

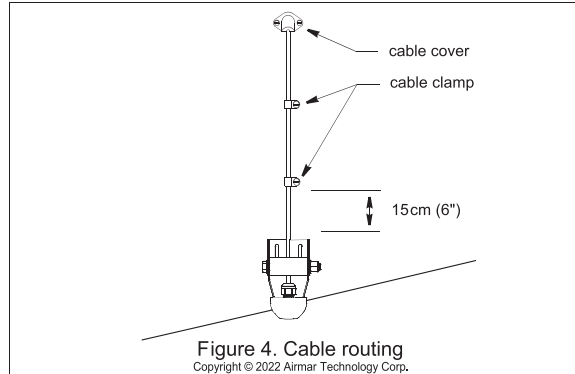

**Checking for Leaks**

When the boat is placed in the water, **immediately** check for leaks around the screws and any other holes drilled in the hull. Note that very small leaks may not be readily observed. Do not leave the boat in the water unchecked for more than three hours.

**Operation & Maintenance**

**Anti-fouling Paint**

Surfaces exposed to salt water that *do not interlock*, must be coated with anti-fouling paint. Use **water-based** anti-fouling paint only. Never use ketone-based paint, since ketones can attack many types of plastic possibly causing damage to the transducer. Reapply paint every 6 months or at the beginning of each boating season.

**Cleaning**

Aquatic growth can accumulate rapidly on the sensor's surface reducing performance within weeks. Clean the transducer's face with a Scotch-Brite® scour pad and mild household detergent taking care to avoid making scratches. If the fouling is severe, lightly wet sand with fine grade wet/dry paper.

**Sensor Replacement & Parts**

The information needed to order a replacement sensor is printed on the cable tag. Do not remove this tag. When ordering, specify the part number, serial number, date, and frequency in kHz. For convenient reference, record this information on the top of page one.

Lost, broken or worn parts should be replaced immediately. Obtain parts from your instrument manufacturer or marine dealer.

Gemeco

USA

Tel: 803-693-0777  
email: sales@gemeco.com

Airmar EMEA

Europe, Middle East, Africa

Tel: +33.(0)2.23.52.06.48  
email: sales@airmar-emea.com



35 Meadowbrook Drive, Milford, New Hampshire 03055-4613, USA  
•www.airmar.com

Copyright © 2022 Airmar Technology Corp. All rights reserved.



# OWNER'S GUIDE & INSTALLATION INSTRUCTIONS

## Sidescan Transducer with Anti-rotation Hardware

Model: **SS904**

Record the information found on the cable tag for future reference.

Part No: \_\_\_\_\_ Serial No: \_\_\_\_\_  
Date: \_\_\_\_\_ Frequency: \_\_\_\_\_ kHz

05/24/22  
102366-rev.1  
D-20553-rev.1

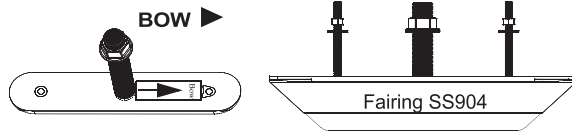

**Follow the precautions below for optimal product performance and to reduce the risk of property damage, personal injury, and/or death.**

**WARNING:** Installation of the anti-rotation studs/screws is mandatory! The anti-rotation studs/screws hold the fairing firmly in place. Failure to install the anti-rotation studs/screws may result in the fairing rotating while the boat is underway. The effect may be violent movement and loss of steering.

**WARNING:** The transducer must be installed parallel to the keel/centerline to ensure proper boat handling and water flow under the transducer.

**WARNING:** Always wear safety glasses, a dust mask, and ear protection when installing.

**WARNING:** Immediately check for leaks when the boat is placed in the water. Do not leave the boat in the water unchecked for more than three hours. Even a small leak may allow a considerable amount of water to accumulate.

**WARNING: Fairing**—The fairing must be screwed to a block of wood before cutting. It is too thin to cut safely without additional material. Failure to do so may result in the fairing moving on the band saw.

**WARNING: Fairing**—Do not install a fairing that has been mis-cut. Replace it.

- Cutting the fairing at an angle greater than the maximum allowed will cut into the transducer and/or anti-rotation pockets, thus weakening the fairing.
- Do not allow any gap between the fairing and the hull that is greater than 1.5mm (1/16"). When the boat is underway, water will enter any gaps and push against the fairing with considerable force, possibly rotating it.

**WARNING: Fiberglass hull**—The transducer must be installed in solid fiberglass, not in coring.

**CAUTION:** Never install a metal transducer on a vessel with a positive ground system.

**CAUTION:** Never pull, carry, or hold the transducer by the cable as this may sever internal connections.

**CAUTION:** Never strike the transducer.

**CAUTION: Stainless steel transducer in a metal hull**—Stainless steel must be isolated from a metal hull to prevent electrolytic corrosion. Use the isolation sleeving supplied.

**CAUTION: Transducer Orientation** —Be sure to install the transducer in the correct orientation to the bow. If the transducer is installed in reverse, the display will not work properly.

**CAUTION: Installation without a Fairing** —The transducer must be installed on a nearly flat hull with less than 10° of deadrise. Do not install on a V-hull. If the transducer is installed without a fairing on a hull with a deadrise greater than 10°, the display will not work properly.

**CAUTION: Transducer Pair** —Be sure to install the port transducer and the starboard transducer in the correct orientation to the bow. If the transducers are installed in reverse, the display will not work properly.

**CAUTION:** Never use solvents. Cleaner, fuel, sealant, paint, and other products may contain solvents that can damage plastic parts, especially the transducer's face.

**IMPORTANT:** Read the instructions completely before proceeding with the installation. These instructions supersede any other instructions in your instrument manual if they differ.

### Applications

- Stainless steel is compatible with all hull materials. Recommended for aluminum hulls to prevent electrolytic corrosion, provided the stainless steel transducer is isolated from the metal hull.
- Recommended for boats capable of speeds up to 30 kn (35 MPH). Optimal speed is 1.5 - 8.5 kn (2 - 10 MPH).
- A fairing is strongly recommended if the deadrise angle of the hull exceeds 10°. The fairing can accommodate a deadrise angle of up to 22°.
- **Transducer Pair** - On a boat with a steep deadrise angle, a pair of transducers, one on the port side and one on the starboard side, can be installed and connected to the echosounder module.
- For stepped hulls, to be installed just ahead of the first step.

**Tools & Materials**

- Safety glasses
- Dust mask
- Ear protection
- Angle finder (installation with fairing)
- Band saw (installation with fairing)
- Block of wood (installation with fairing) min. 4" x 4" x 18"
- Screws (4) (installation with fairing) No. 8
- Screwdrivers
- Rasp or power tool (installation with fairing)
- Electric drill
- Drill bits and hole saws:
  - Pilot hole 3mm or 1/8"
  - Transducer stem 25mm or 1"
  - Anti-rotation studs in solid fiberglass or wood hull 9mm or 11/32"
  - Anti-rotation studs in metal hull 10mm or 3/8"
- Sandpaper
- Mild household detergent or weak solvent (such as alcohol)
- File (installation in metal hull)
- Marine sealant (suitable for below waterline)
- Slip-joint pliers
- Grommet(s) (some installations)
- Cable ties
- Water-based anti-fouling paint (**mandatory in salt water**)
- Installation in a cored fiberglass hull: (see page 8)
  - Drill bits and hole saws for hull interior:
    - Transducer stem 38mm or 1-1/2"
    - Anti-rotation studs 19mm or 3/4"
  - Cylinder, wax, tape, and casting epoxy

**Mounting Location**

*Guidelines*

**CAUTION:** Do not mount in line with or near water intake or discharge openings or behind strakes, struts, fittings, or hull irregularities that will disturb the water flow.

**CAUTION:** Do not mount the sensor where the boat may be supported during trailering, launching, hauling, or storage to avoid damaging the transducer's face.

- The water flowing under the hull must be smooth with a minimum of bubbles and turbulence (especially at high speeds).
- The transducer must be continuously immersed in water.
- The transducer beam must be unobstructed by the keel or propeller shaft(s).
- Choose a location away from interference caused by power and radiation sources such as: the propeller(s) and shaft(s), other machinery, other echosounders, and other cables. The lower the noise level, the higher the echosounder gain setting that can be used.
- Choose an accessible spot inside the vessel with adequate space for the height of the stem and tightening the nuts.
- Choose a location with a minimal deadrise angle. If the hull has a steep deadrise, mount a pair of transducers.

**Boat Types** (Figure 1)

- **Planing hull powerboat**—Mount well aft near the centerline and *well inboard of the first set of lifting strakes* to insure that it is in contact with the water at high speeds. The starboard side of the hull where the propeller blades are moving downward is preferred.
  - Outboard and I/O**—Mount just forward and to the side of the engine(s).
  - Inboard**—Mount well ahead of the propeller(s) and shaft(s).
  - Stepped hull**—Mount just ahead of the first step.
- **Displacement hull powerboat**—Locate 1/3 of the way along the LWL and 150–300mm (6–12") off the centerline. The starboard side of the hull where the propeller blades are moving downward is preferred.
  - Transducer Pair**—Mount the transducers across from one another on opposite sides of the centerline (keel).

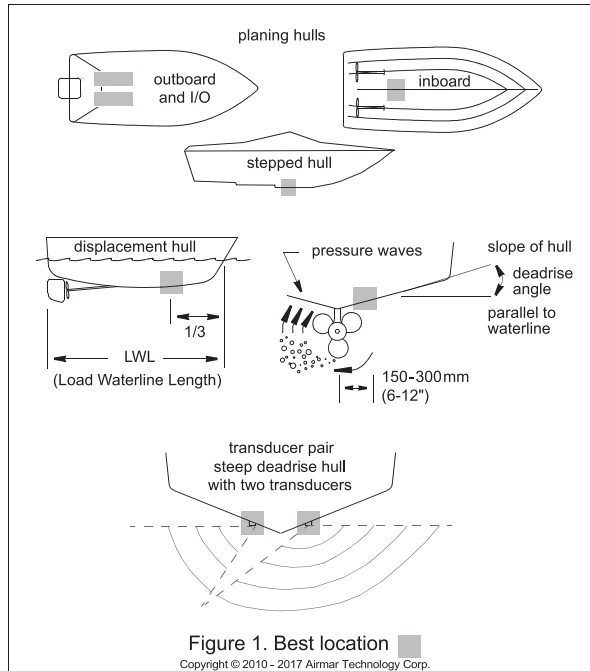



## APPX. 1 TRANSDUCER INSTALLATION GUIDE

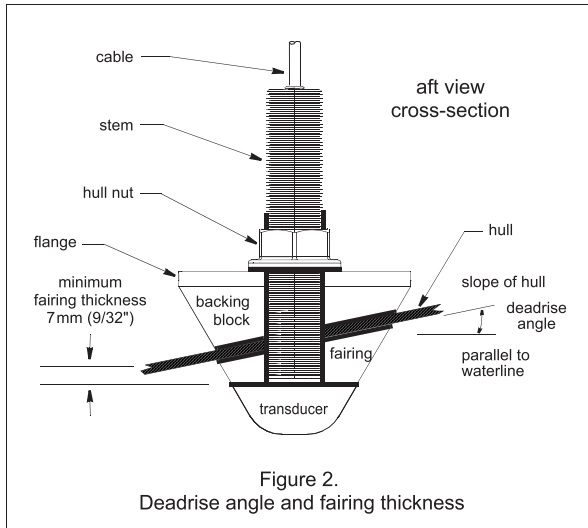

Figure 2.  
Deadrise angle and fairing thickness

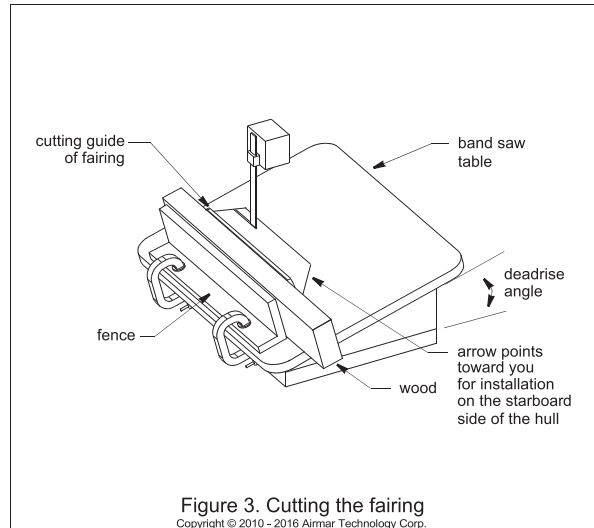

Figure 3. Cutting the fairing  
Copyright © 2010 - 2016 Airmar Technology Corp.

### Installation:

**NOTE:** If you are installing the transducer with NO fairing, disregard all references to a fairing and backing block. Skip to "Hole Drilling" on page 3.

### Cutting the Fairing

**CAUTION:** The arrow on the fairing points forward toward the bow when installed. Be sure to orient the fairing on the band saw, so the angle cut matches the intended side of the hull and not the mirror image.

**CAUTION:** Shape the fairing to the hull as precisely as possible. If there are gaps between the fairing and the hull near the ends, cut a new fairing. Over tightening the rods to minimize gaps may crack the transducer and/or crush the fairing.

- 1. Metal hull**—The holes for the anti-rotation studs must be enlarged to accommodate the isolation sleeving. Using a 10mm (3/8") drill bit, enlarge the two holes in the fairing.
- Measure the deadrise angle of the hull at the selected mounting location using an angle finder or a digital level (Figure 3).
- Tilt the band saw table to the measured angle and secure the cutting fence (Figure 4).
- Fasten the fairing to the center of the block of wood using the four corner holes and No. 8 screws.
- Place the fairing on the table so the cutting guide rests against the fence. The arrow will be pointing *toward* you for installation on the starboard side of the boat or *away* from you for installation on the port side (Figure 5).
- Adjust the cutting fence, so the fairing will be cut in about two equal parts (Figure 3). *The section that will become the fairing must be a minimum of 7mm (9/32") at its thinnest dimension.* This number corresponds to the flange on the fairing.
- Recheck steps 1 through 5. Then cut the fairing.
- Check the fit of the fairing by placing it against the hull, being sure it is parallel to the centerline of the boat (keel).** Hold the fairing on the ends and try to rock it back and forth. Shape the fairing to the hull as precisely as possible with a rasp or power tool until it no longer rocks.

- Remove the fairing from the block of wood.
- Use the remaining section of the fairing with the cutting guide as the backing block.

### Hole Drilling

**Cored fiberglass hull**—Follow separate instructions on page 6.

- Locate and drill the holes for the transducer stem and anti-rotation studs, using the fairing or the provided template on page 8 as a guide (Figure 4, 5, 6, or 7). Align the fairing or template parallel to the centerline of the boat (keel).
  - Drill 3mm (1/8") pilot holes for the transducer stem and the two anti-rotation studs.
  - Using the appropriate drill bits/hole saw, drill the holes for the transducer stem and the two anti-rotation studs.
 

**Fairing**—Drill through the holes in the fairing to be sure the holes are drilled *perpendicular to the waterline* and not at the angle of the hull.

**NO Fairing**—Be sure to drill the holes perpendicular to the hull.
- Sand and clean the area around the holes, inside and outside, to ensure the marine sealant will adhere properly to the hull. If there is any petroleum residue inside the hull, remove it with either a mild household detergent or a weak solvent (alcohol) before sanding.
 

**Metal hull**—Remove all burrs with a file and sandpaper.

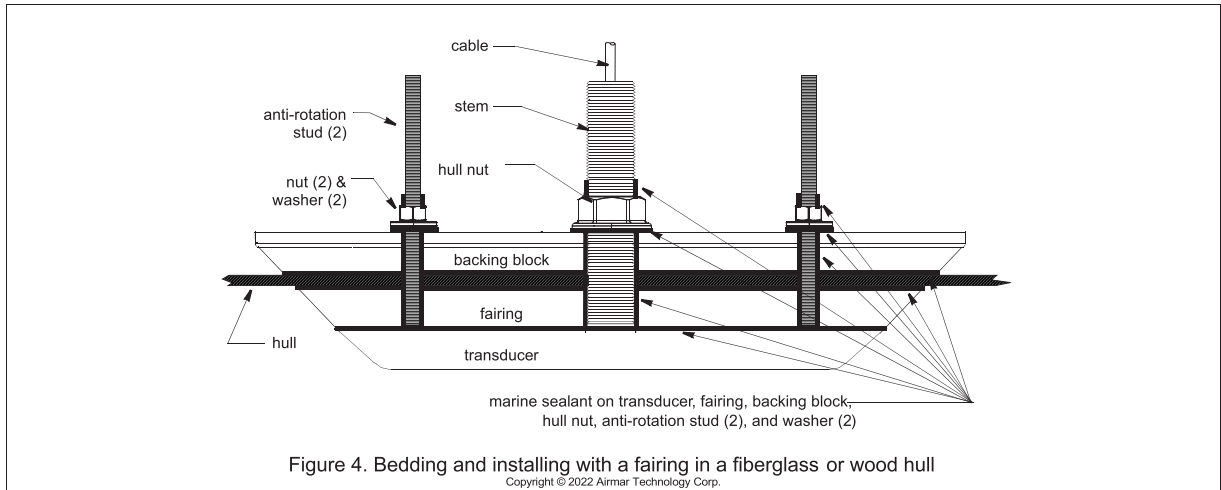

**Bedding**

**CAUTION:** Be sure all surfaces to be bedded are clean and dry.

**CAUTION:** When installing the anti-rotation studs, use slip-joint pliers placed near the bottom of the stud. Do not use pliers farther up, as this will damage the threads.

1. Remove the hull nut (Figure 4, 5, 6, or 7).
2. Apply a 2mm (1/16") thick layer of marine sealant to the surface of the transducer that will contact the hull/fairing and up the stem. *The sealant must extend 6mm (1/4") higher than the combined thickness of the hull, fairing and backing block (if used), and the hull nut.* This will ensure there is marine sealant in the threads to seal the hull and hold the hull nut securely in place.
3. Apply a 2mm (1/16") thick layer of marine sealant around the anti-rotation studs *including the bottom.* This will ensure there is marine sealant in the threads to secure the studs in the transducer, seal the hull, and hold the nut securely in place.
4. Screw the anti-rotation studs into the holes in the transducer. Using slip-joint pliers placed *near the bottom of the stud*, tighten

each one in turn. Do not use pliers farther up, as this will damage the threads.

5. **Metal hull**—Use the isolation sleeving to cover the transducer stem and the two anti-rotation studs. Cut the length of each sleeve greater than the thickness of the hull. *Note that the sleeves must not interfere with tightening the nuts.* Slide the larger diameter isolation sleeve over the bedded transducer stem. Slide the two remaining isolation sleeves over the bedded anti-rotation studs. Slide the sleeves as far down as possible. Apply a 2mm (1/16") thick layer of the marine sealant to the outside of the three isolation sleeves.

6. **Fairing**—Thread the transducer cable through the fairing. Seat the transducer firmly within the recess in the fairing. Apply a 2mm (1/16") thick layer of marine sealant to the following surfaces:

- Fairing that will contact the hull
- Backing block that will contact the hull
- Hull nut that will contact the backing block
- Washers for the anti-rotation studs that will contact the backing block

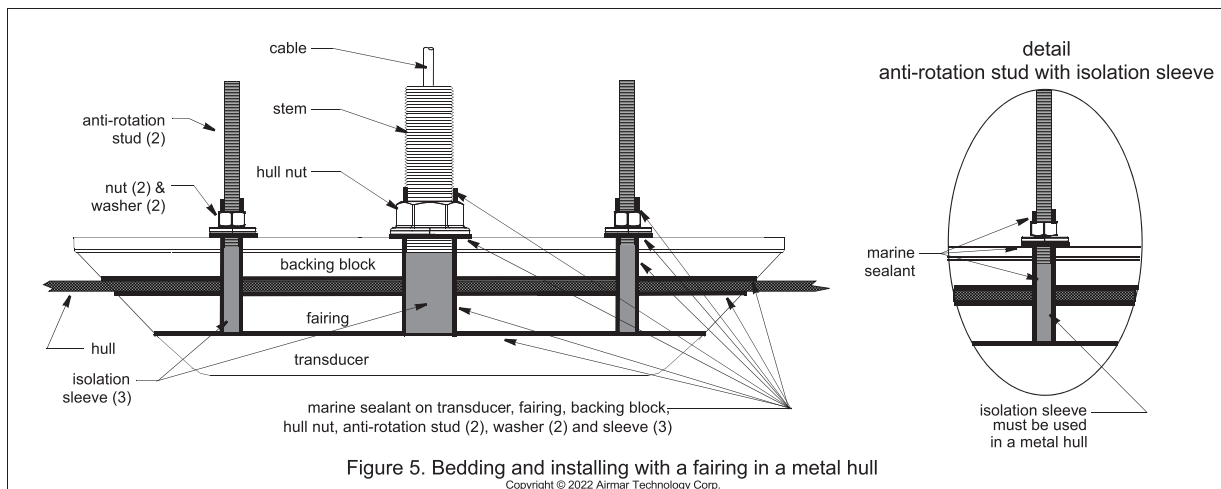

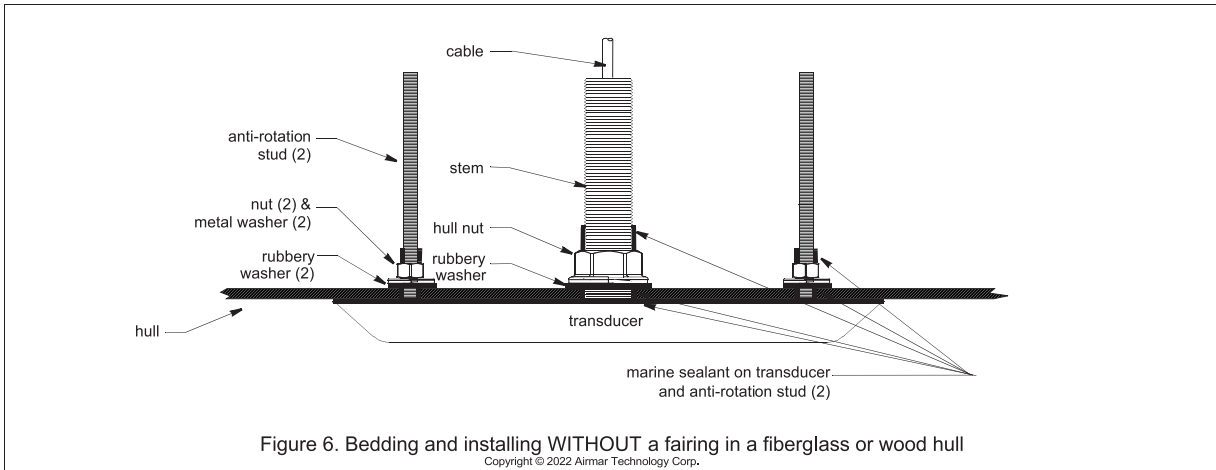

**Installing**

**CAUTION:** Do not over-tighten the nuts possibly damaging the transducer or fairing.

1. From outside the hull, thread the cable through the mounting hole (Figure 4, 5, 6, or 7).
2. Push the stem of the transducer and the anti-rotation studs through the hull.
3. From inside the hull:

- **Fairing**—Slide the backing block and the hull nut onto the cable. Seat the backing block firmly against the hull. Screw the hull nut in place and tighten it with slip-joint pliers. *Do not over-tighten.* With the bedded side down, slide one washer and nut onto each anti-rotation stud. Tighten the nuts *one full turn only* with slip-joint pliers. *Do not over-tighten.*
- **Cored fiberglass hull**—*Do not over-tighten* crushing the hull.
- **Wood hull**—Allow for the wood to swell before tightening.
- **Metal hull**—Be sure the isolation sleeves are between the transducer stem/studs and the hull. *The isolation sleeves must be below the nuts to prevent the sleeves from interfering with tightening the nuts.* Trim the sleeves if necessary.

- **NO fairing**—Slide the rubbery washer and hull nut onto the cable. Seat the rubbery washer firmly against the hull. Screw the hull nut in place and tighten it with slip-joint pliers. *Do not over-tighten.* Slide the rubbery washer, metal washer, and nut onto each anti-rotation stud. Seat the rubbery washer firmly against the hull. Tighten the nuts *one full turn only* with slip-joint pliers. *Do not over-tighten.*
  - **Cored fiberglass hull**—*Do not over-tighten* crushing the hull.
  - **Wood hull**—Allow for the wood to swell before tightening.
  - **Metal hull**—Be sure the isolation sleeves are between the transducer stem/studs and the hull. *The isolation sleeves must be below the nuts to prevent the sleeves from interfering with tightening the nuts.* Trim the sleeves if necessary.
4. **Fairing**—When the boat is underway, especially at high speeds, water will enter any gaps and push against the fairing with considerable force, possibly rotating it. Fill any gaps between the fairing and the hull with marine sealant. **If there is any gap greater than 1.5 mm (1/16"), replace the fairing.**
  5. Remove any excess marine sealant on the outside of the hull, transducer, and fairing if used to ensure smooth water flow under the transducer.

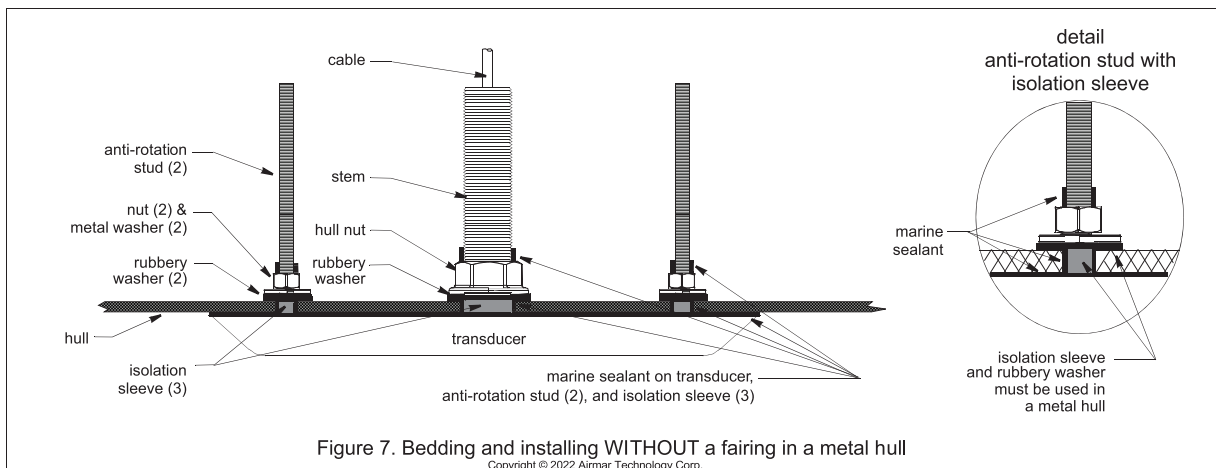



### Installation in a Cored Fiberglass Hull

The core (wood or foam) must be cut and sealed carefully. The core must be protected from water seepage, and the hull must be reinforced to prevent it from crushing under the hull nut allowing the transducer(s) to become loose.

**CAUTION:** Completely seal the hull to prevent water seepage into the core.

1. Drill a 3 mm or 1/8" pilot hole perpendicular to the waterline from inside the hull (Figure 8). If there is a rib, strut, or other hull irregularity near the selected mounting location, drill from the outside. If the hole is drilled in the wrong location, drill a second hole in a better location. Apply masking tape to the outside of the hull over the incorrect hole and fill it with epoxy.
2. Using the appropriate size drill bit/hole saw, cut a hole from outside the hull through the outer skin only. Be sure to hold the drill plumb, so the hole will be perpendicular to the water surface.
3. The optimal interior hole diameter is affected by the hull's thickness and deadrise angle. It must be large enough in diameter to allow the core to be completely sealed.
4. Using the drill bit/hole saw for the hull interior, cut through the *inner* skin and most of the core from inside the hull keeping the drill perpendicular to the hull. The core material can be very soft. Apply only light pressure to the drill bit after cutting through the *inner* skin to avoid accidentally cutting the *outer* skin.
5. Remove the plug of core material so the *inside* of the outer skin and the inner core of the hull is fully exposed. Sand and clean the inner skin, core, and the outer skin around the hole.
6. Coat a hollow or solid cylinder of the correct diameter with wax and tape it in place. Fill the gap between the cylinder and hull with casting epoxy. After the epoxy has set, remove the cylinder.
7. Sand and clean the area around the hole, inside and outside, to ensure that the sealant will adhere properly to the hull. If there is any petroleum residue inside the hull, remove it with either mild household detergent or a weak solvent (alcohol) before sanding.
8. Follow the same procedure to prepare the hull for each anti-rotation stud/screw (steps 1 through 6).
9. Proceed with "Bedding" on page 4.

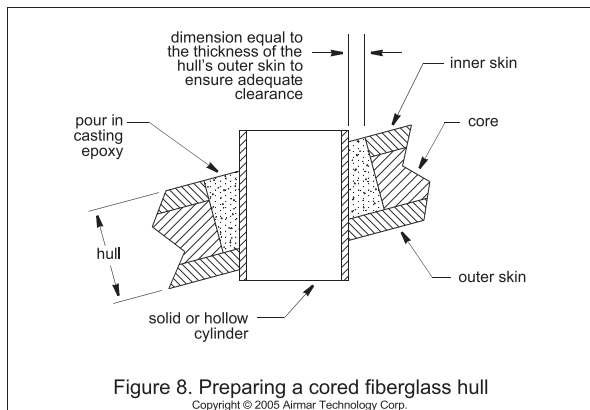

### Cable Routing & Connecting

**CAUTION:** Do not remove the connector(s) to ease cable routing. If a cable must be cut and spliced, use Airmar's splash-proof Junction Box No. 33-035 and follow the instructions provided. Removing the waterproof connector or cutting the cable, except when using a water-tight junction box, will void the sensor warranty.

1. Refer to the instructions that came with the echo sounder module to connect it to the display and the power supply.
2. **Transducer Pair**—Connect the starboard transducer to the short cable on the port transducer. Rout the longer cable on the port transducer to the echo sounder module (Figure 9).

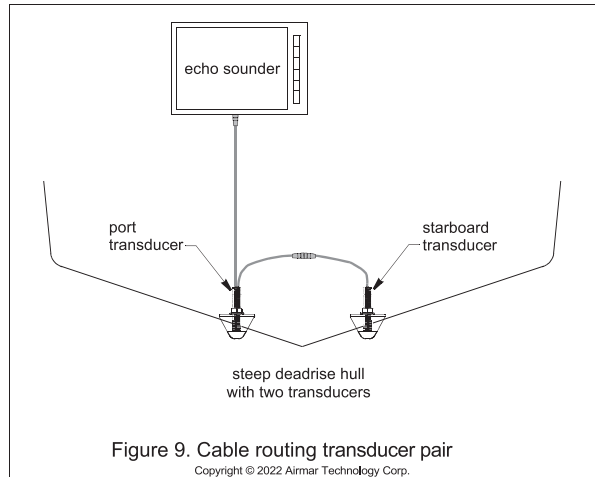

### Maintenance, Parts & Replacement

#### Anti-fouling Coating

Surfaces exposed to salt water must be covered with an anti-fouling coating. Use a *water-based* anti-fouling coating made for transducers only. Never use ketone based paint, since ketones can attack many plastics possibly damaging the transducer. Brush on anti-fouling coating every 6 months or at the beginning of each boating season.

#### Checking for Leaks

When the boat is placed in the water, **immediately** check around the transducer(s) for leaks. Note that very small leaks may not be readily observed. Do not leave the boat in the water for more than 3 hours before checking it again. If there is a small leak, there may be considerable bilge water accumulation after 24 hours. If a leak is observed, repeat "Bedding" and "Installing" **immediately**.

#### Cleaning

Aquatic growth can accumulate rapidly on the transducer's surface reducing its performance within weeks. Clean the surface with a Scotch-Brite® scour pad and mild household detergent taking care to avoid making scratches. If the fouling is severe, lightly wet sand with fine grade wet/dry paper.

## APPX. 1 TRANSDUCER INSTALLATION GUIDE

### *Transducer Replacement & Parts*

The information needed to order a replacement transducer is printed on the cable tag. Do not remove this tag. When ordering, specify the part number, serial number, date, and frequency in kHz. For convenient reference, record this information on the top of page 1.

Lost, broken, and worn parts should be replaced immediately.

Obtain parts from your instrument manufacturer or marine dealer.

Model	Fairing	Hull Nut
SS904	ACC-FAIR-SS904-01	02-149-01

#### Gemeco

#### USA

Tel: 803-693-0777  
Email: sales@gemeco.com

#### Airmar EMEA

#### Europe, Middle East, Africa

Tel: +33.(0)2.23.52.06.48  
Email: sales@airmar-emea.com



35 Meadowbrook Drive, Milford, New Hampshire 03055-4613, USA  
• www.airmar.com

Copyright © 2012 - 2018 Airmar Technology Corp. All rights reserved.

**Template**  
SS904

**IMPORTANT:** Some printers and printer settings can alter the size of the template.

Verify the template's size before cutting. Place the transducer on the template to be sure it is the *exact* size. If necessary, redraw the template.

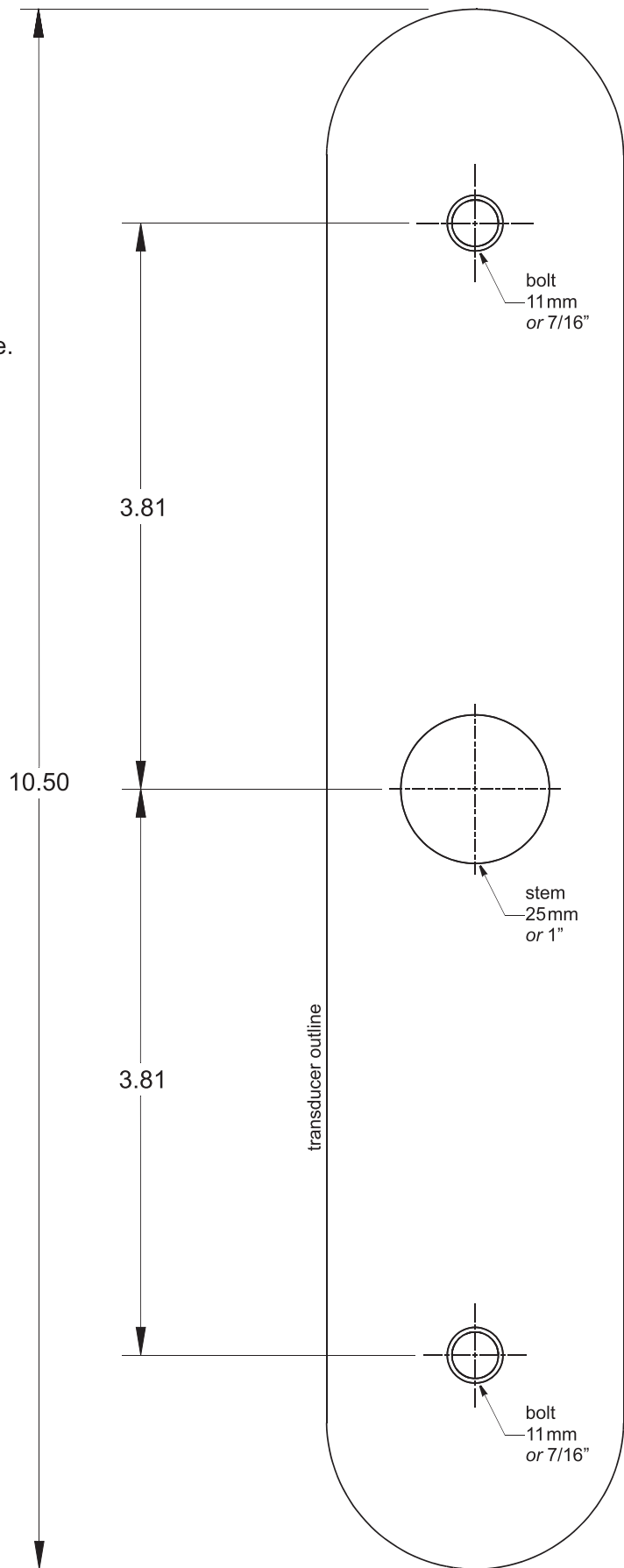

# APPX. 2 TRANSDUCER LIST

The tables below show all available transducers, whether they are compatible with the functions listed, and connection port.

**Note:** Applicable for the TZT16X only.

## Optional transducers

### Standard transducers (CW narrow band)

Model	ACCU-FISH™	Bottom Disc.	Port	Remarks		
520-5PSD	Yes	Yes	XDR*1	600 W		
520-5MSD	Yes	Yes				
525-5PWD	Yes	Yes				
525STID-MSD	Yes	Yes				
525STID-PWD	Yes	Yes				
520-PLD	Yes	Yes				
525T-BSD	Yes	Yes				
525T-PWD	Yes	Yes				
525T-LTD/12	Yes	Yes				
525T-LTD/20	Yes	Yes				
SS60-SLTD/12	Yes	Yes				
SS60-SLTD/20	Yes	Yes				
526TID-HDD	Yes	Yes			XDR*2	1 kW
50/200-1T	Yes	Yes				
50B-6	No	No				
50B-6B	No	No				
200B-5S	No	No				

\*1: Connect with the cable assembly FRU-CCB12-MJ-01-BU (000-200-955-10, standard supply).

\*2: Connect with the matching box MB-1100 (000-041-353, optional supply).

### CHIRP transducers

Model	ACCU-FISH™	Bottom Disc.	Port	Remarks
TM150M	No	No	XDR*3	300W
B-75L	No	No		
B-75H	No	No		
B-175H	No	No		
B-175L	No	No		
B265LH-FJ12	Yes	No	XDR*4*5	1kW
CM265LH-FJ12	Yes	No		
TM265LH-FJ12	Yes	No		

\*3: Connect with cable assembly FRU-CCB12-MJ-01-BU (000-200-955-10, standard supply).

\*4: Connect directly to the XDR port.

\*5: Cannot be used simultaneously with the CHIRP Side Scan transducers.

## AP-12

Side Scan transducers

Model	ACCU-FISH™	Bottom Disc.	Port	Remarks
225T-TM904	No	No	SIDE SCAN* <sup>6</sup>	150 W
225T-SS904	No	No		
225T-PR904	No	No		
455T-TM903	No	No		
455T-SS903	No	No		
455T-PR903	No	No		

\*<sup>6</sup>: Connect directly to the SIDE SCAN port.

Other compatible transducersCHIRP transducers (single frequency)

Model	ACCU-FISH™	Bottom Disc.	Port	Remarks	
B75HW	No	No	XDR* <sup>7</sup>	300 W	
B150M	No	No			
P95M	No	No			
SS75L	No	No			
B75M	No	No		600 W	
B785M	No	No			
P75M	No	No			
SS75H	No	No			
SS75M	No	No			
TM165HW	No	No			
B175HW	No	No			1 kW
B175M	No	No			
B175MW	No	No			
B285HW	No	No			
B285M	No	No			
SS175MW	No	No			
TM185HW	No	No			
TM185M	No	No			
TM185MW	No	No			

\*<sup>7</sup>: Connect with cable assembly FRU-CCB12-MJ-01-BU (000-200-955-10, standard supply).

CHIRP/CW transducers (dual frequency)

Model	ACCU-FISH™	Bottom Disc.	Port	Remarks
165T-50/200-SS260	No	No	XDR <sup>*8</sup>	1 kW
165T-50/200-TM260	No	No		
165T/265LH-PM488-12P	No	No	XDR <sup>*9,*10</sup>	
165T/275LHW-12P	No	No		
B275LHW-FJ12	No	No		
B265LM-FJ12	No	No		
CM265LM-FJ12	No	No		
CM275LHW-FJ12	No	No		
TM265LM-FJ12	No	No		
TM275LHW-FJ12	No	No		

\*8: Connect with cable assembly FRU-CCB12-MJ-01-BU (000-200-955-10, standard supply).













\*9: Connect directly to the XDR port.

\*10: Cannot be used simultaneously with the CHIRP Side Scan transducers.

PACKING LIST

19BP-X-9853-0 1/1

TZT16X-E/-J

N A M E	PRODUCT NAME	O U T L I N E	DESCRIPTION / CODE No.	QTY
ユニット UNIT	指示部 Multi Function Display UNIT		TZT16X- 0016905000 **	1
予備品 SPARE PARTS	ヒューズ(7.5A) FUSE (7.5A)		FRU-80V-FU-7.5A 00019491410	1
付属品 ACCESSORIES	フレッククリーナー LCD CLEANING CLOTH		19-028-3125-7 1003887710	1
付属品 ACCESSORIES	SDカード(メモリー) MICRO SD CARD		JE07012-C170/171 9999980410 **	1
工事材料 INSTALLATION MATERIALS	マウントメタル MOUNT METAL		JE07012-Y540 9999980610	4
工事材料 INSTALLATION MATERIALS	ネジ袋詰め品 PACKAGED SCREW		JE07012-B368 0002019510	1
工事材料 INSTALLATION MATERIALS	ネジカバー TZX16X用 SCREW COVER For TZT16X		JE07012-Y930 9999980910	2
工事材料 INSTALLATION MATERIALS	電源ケーブル POWER CABLE		FRU-3P-FF-A002M-002R 00020108710	1
工事材料 INSTALLATION MATERIALS	ネットワークケーブル NETWORK CABLE		FRU-RZWPWP-005G 00020033910	1
工事材料 INSTALLATION MATERIALS	魚探ケーブル FISH FINDER CABLE		FRU-C0B12-MJ-01-BU 00020095510	1
図書 DOCUMENT	取扱要領書(和/英) INSTALLATION MANUAL(JP/EN) TZT16X/22X/24X		IM-45240- 0002001431* **	1
図書 DOCUMENT	操作要領書(和/英) OPERATOR'S GUIDE(JP/EN) TZT10X/13X/16X/22X/24X		OS-45240- 0002001451* **	1
図書 DOCUMENT	型紙(サイズ:A3/TZT16X) (和/英) FLUSH MOUNTING TEMPLATE (SIZE: A3/TZT16X) (JP/EN)		C42-02209- 0002011481*	1

\*1 コード番号末尾の[\*\*]は、選択品の代表コードを表します。  
CODE NUMBER ENDING WITH "\*\*" INDICATES THE CODE NUMBER OF REPRESENTATIVE MATERIAL.















(略図の寸法は、参考値です。 DIMENSIONS IN DRAWING FOR REFERENCE ONLY.)

JE07012-Y674

PACKING LIST

19BN-X-9851-0 1/1

TZT22X-E/-J

N A M E	PRODUCT NAME	O U T L I N E	DESCRIPTION / CODE No.	QTY
ユニット UNIT	指示部 Multi Function Display UNIT		TZT22X- 00164278000 **	1
予備品 SPARE PARTS	ヒューズ(10A) FUSE (10A)		FRU-80V-FU-10A 00019491410	1
付属品 ACCESSORIES	フレッククリーナー LCD CLEANING CLOTH		19-028-3125-7 1003887710	1
付属品 ACCESSORIES	SDカード MICRO SD CARD		JE07012-C170/171 9999980410 **	1
工事材料 INSTALLATION MATERIALS	マウントメタル MOUNT METAL		JE07012-Y140 9999980110	4
工事材料 INSTALLATION MATERIALS	ネジ袋詰め品 PACKAGED SCREW		JE07012-B392 00020066410	1
工事材料 INSTALLATION MATERIALS	ネジカバー TZX22X用 SCREW COVER For TZT22X		JE07012-Y030 9999980210	2
工事材料 INSTALLATION MATERIALS	電源ケーブル POWER CABLE		FRU-3P-FF-A002M-001R 00020032910	1
工事材料 INSTALLATION MATERIALS	ネットワークケーブル NETWORK CABLE		FRU-RZWPWP-005G 00020033910	1
図書 DOCUMENT	取扱要領書(和/英) INSTALLATION MANUAL(JP/EN) TZT22X/24X		IM-45240- 0002001541* **	1
図書 DOCUMENT	操作要領書(和/英) OPERATOR'S GUIDE(JP/EN) TZT22X/24X		OS-45240- 0002001561* **	1
図書 DOCUMENT	型紙(サイズ:A2/TZT22X) (和/英) FLUSH MOUNTING TEMPLATE (SIZE: A2/TZT22X) (JP/EN)		C42-02208- 0002001511*	1

\*1 コード番号末尾の[\*\*]は、選択品の代表コードを表します。  
CODE NUMBER ENDING WITH "\*\*" INDICATES THE CODE NUMBER OF REPRESENTATIVE MATERIAL.

\*2 SDカードは、仕様と仕様で容量が異なります。  
MEMORY CAPACITY DEPENDS ON SPECIFICATION (E or J).















(略図の寸法は、参考値です。 DIMENSIONS IN DRAWING FOR REFERENCE ONLY.)

JE07012-Y061

PACKING LIST

19BN-X-9852-0 1/1

TZT24X-E/-J

N A M E	PRODUCT NAME	O U T L I N E	DESCRIPTION / CODE No.	QTY
ユニット UNIT	指示部 Multi Function Display UNIT		TZT24X- 0018428000 **	1
予備品 SPARE PARTS	ヒューズ(10A) FUSE (10A)		FRU-80V-FU-10A 00019491410	1
付属品 ACCESSORIES	フレッククリーナー LCD CLEANING CLOTH		19-028-3125-7 1003887710	1
付属品 ACCESSORIES	SDカード MICRO SD CARD		JE07012-C170/171 9999980410 **	1
工事材料 INSTALLATION MATERIALS	マウントメタル MOUNT METAL		JE07012-Y140 9999980110	4
工事材料 INSTALLATION MATERIALS	ネジ袋詰め品 PACKAGED SCREW		JE07012-B392 00020066410	1
工事材料 INSTALLATION MATERIALS	ネジカバー TZX24X用 SCREW COVER For TZT24X		JE07012-Y230 9999980310	2
工事材料 INSTALLATION MATERIALS	電源ケーブル POWER CABLE		FRU-3P-FF-A002M-001R 00020032910	1
工事材料 INSTALLATION MATERIALS	ネットワークケーブル NETWORK CABLE		FRU-RZWPWP-005G 00020033910	1
図書 DOCUMENT	取扱要領書(和/英) INSTALLATION MANUAL(JP/EN) TZT22X/24X		IM-45240- 0002001541* **	1
図書 DOCUMENT	操作要領書(和/英) OPERATOR'S GUIDE(JP/EN) TZT22X/24X		OS-45240- 0002001561* **	1
図書 DOCUMENT	型紙(サイズ:A2/TZT24X) (和/英) FLUSH MOUNTING TEMPLATE (SIZE: A2/TZT24X) (JP/EN)		C42-02209- 0002001521*	1

\*1 コード番号末尾の[\*\*]は、選択品の代表コードを表します。  
CODE NUMBER ENDING WITH "\*\*" INDICATES THE CODE NUMBER OF REPRESENTATIVE MATERIAL.

\*2 SDカードは、仕様と仕様で容量が異なります。  
MEMORY CAPACITY DEPENDS ON SPECIFICATION (E or J).



(略図の寸法は、参考値です。 DIMENSIONS IN DRAWING FOR REFERENCE ONLY.)

JE07012-Y063

工事材料表

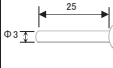
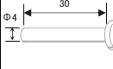
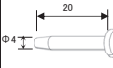
番号 NO.	名称 NAME	略図 OUTLINE	型名/規格 DESCRIPTIONS	数量 QTY	用途/備考 REMARKS
1	ネジ(M3) SCREW (M3)		J6-SBD3-25200 CODE NO.	8	
2	ネジ(M4) SCREW (M4)		J6-SBD4-30200 CODE NO.	8	
3	ネジ(呼び4) SCREW (D4)		JE82001-0026 CODE NO.	8	
MFR'S NAME: FURUNO ELECTRIC CO.,LTD. DWG NO. 1/1					

(略図の寸法は、参考値です。 DIMENSIONS IN DRAWING FOR REFERENCE ONLY.)



表1 TABLE 1

寸法区分 (mm) DIMENSION	公差 (mm) TOLERANCE
L ≤ 50	±1.5
50 < L ≤ 100	±2.5
100 < L ≤ 500	±3

NOTE

1. TABLE 1 INDICATES TOLERANCE OF DIMENSIONS WHICH IS NOT SPECIFIED.
2. # MINIMUM SERVICE CLEARANCE.
3. USE TAPPING SCREWS  $\phi 5 \times 20$  FOR FIXING THE UNIT.

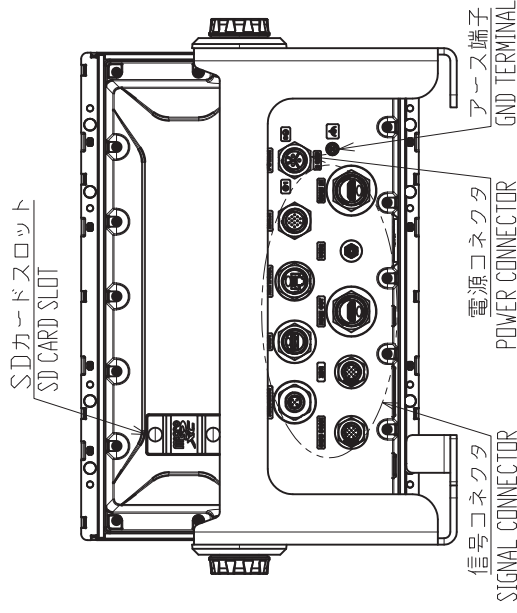
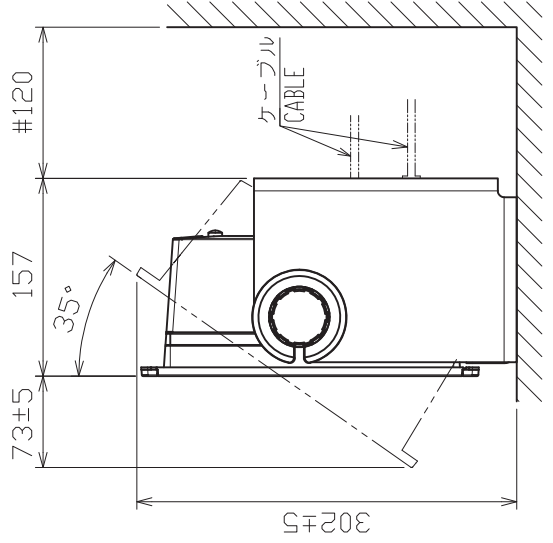
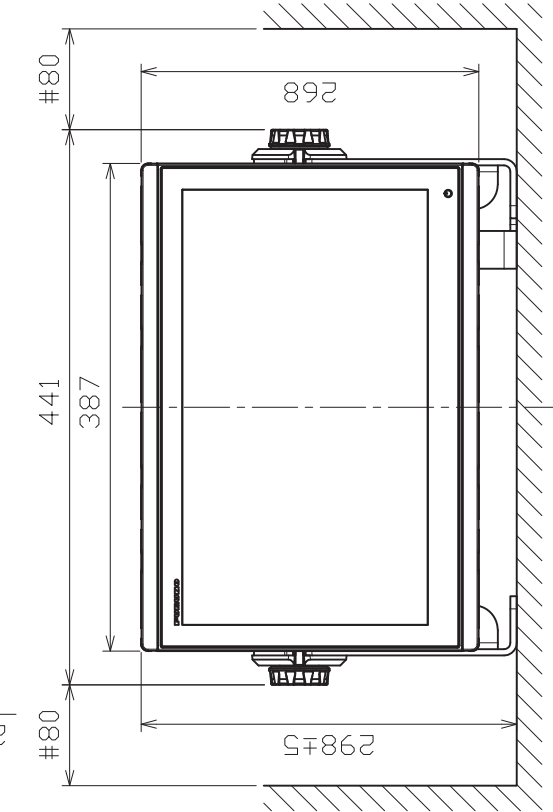
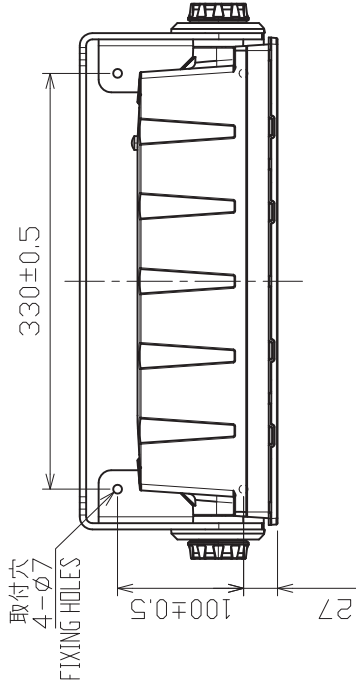
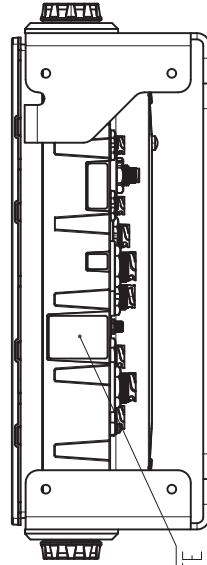

注記

- 1) 指定外の寸法公差は表 1 による。
- 2) #印寸法は最小サービス空間寸法とする。
- 3) 取付用ネジはトラスタツ呼び径  $5 \times 20$  を使用のこと。

DRAWN	23/Jan/2024 S.HAN	TITLE	TZT16X
CHECKED	23/Jan/2024 T.YAMASAKI	名称	マルチファンクションディスプレイ (卓上装備)
APPROVED	19/Feb/2024 H.MAKI	外寸図	
SCALE	1/6	NAME	MULTI FUNCTION DISPLAY (TABLETOP MOUNT)
DWG No.	C4528-G03-A	REF No.	19-036-12EG-1
			OUTLINE DRAWING



表1 TABLE 1

寸法区分 (mm) DIMENSION	公差 (mm) TOLERANCE
L ≤ 50	±1.5
50 < L ≤ 100	±2.5
100 < L ≤ 500	±3

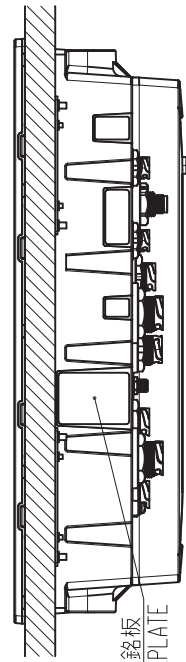
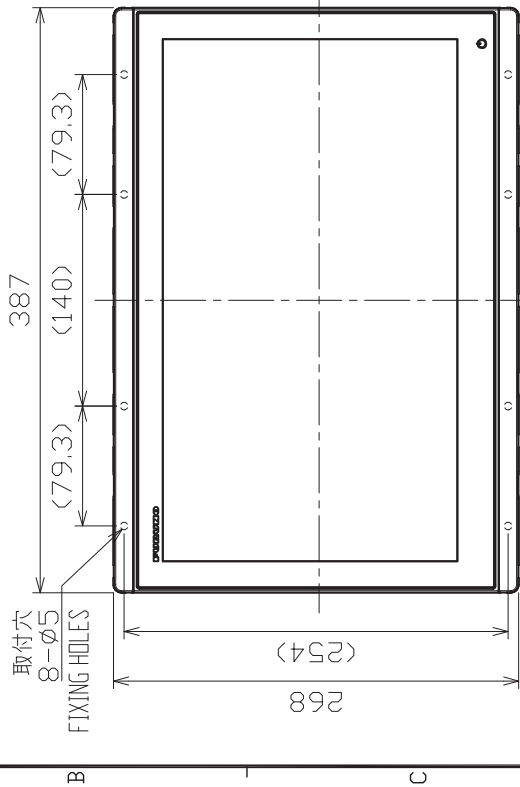
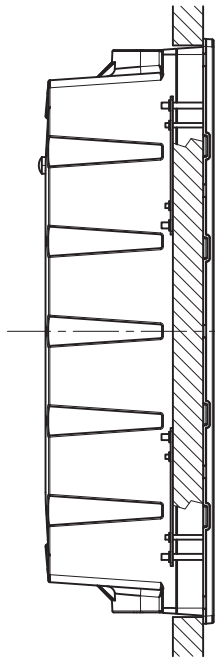

型式銘板  
NAMEPLATE

注 記

- 1) 指定外の寸法公差は表1による。
- 2) #印寸法は最小サービス空間寸法とする。
- 3) 壁の厚さ(B)は最小5, 最大20とする。
- 4) 取付金具はバインドネジM3×25、本体はバインドネジM4×30で固定する。

2

1

5

4

3

2

1

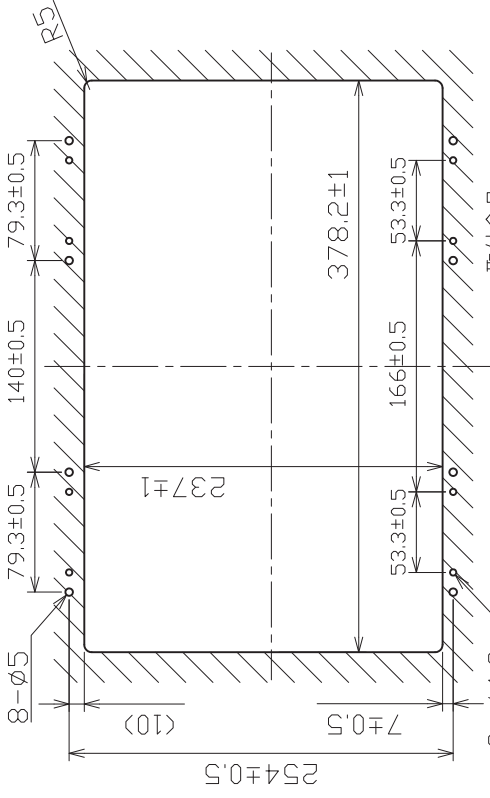

S.Dカードスロット  
SD CARD SLOT

取付金具  
FIXTURE

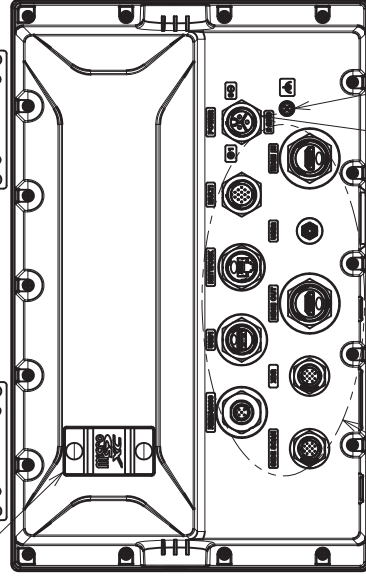

信号コネクタ  
SIGNAL CONNECTOR

電源コネクタ  
POWER CONNECTOR

アース端子  
GND TERMINAL

109 #150

7

(B)

NOTE

1. TABLE 1 INDICATES TOLERANCE OF DIMENSIONS WHICH IS NOT SPECIFIED.
2. # MINIMUM SERVICE CLEARANCE.
3. BULKHEAD THICKNESS (B): 5 ≤ B ≤ 20.
4. USE BINDING SCREWS M3×25 FOR FIXING THE FIXTURES, AND USE BINDING SCREWS M4×30 FOR FIXING THE UNIT.

DRAWN 23/Jun/2024 S.HAN	TITLE TZT16X
CHECKED 23/Jun/2024 T.YAMASAKI	名称 マルチファンクションディスプレイ (埋込装備2)
APPROVED 19/Feb/2024 H.MAKI	外寸図
SCALE 1/5	壁厚はケーブルを含まず MASS DOES NOT INCLUDE CABLE.
DWG No. C4528-G02-A	19-036-121G-1

1

表1 TABLE 1

寸法区分 (mm) DIMENSION	公差 (mm) TOLERANCE
L ≤ 50	±1.5
50 < L ≤ 100	±2.5
100 < L ≤ 500	±3

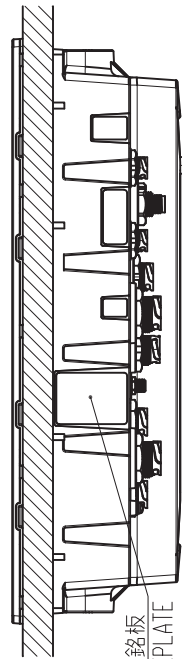
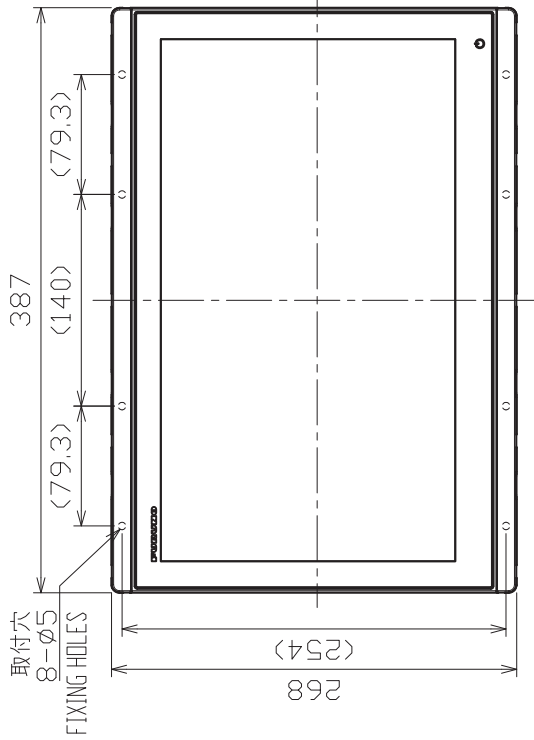
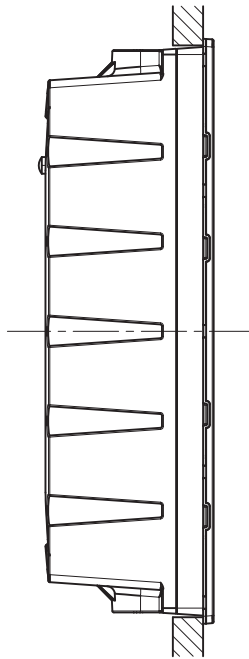

注記

- 1) 指定外の寸法公差は表1による。
- 2) 印寸法は最小サービス空間寸法とする。
- 3) 取付用ネジはバインドタツピンネジ呼び径4×2.0を使用のこと。

8-取付穴位置  
PILOT HOLES

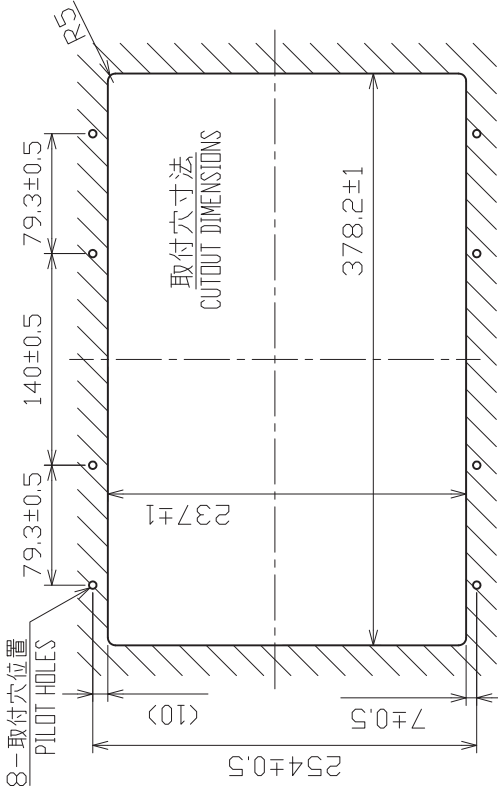

SDカードスロット  
SD CARD SLOT

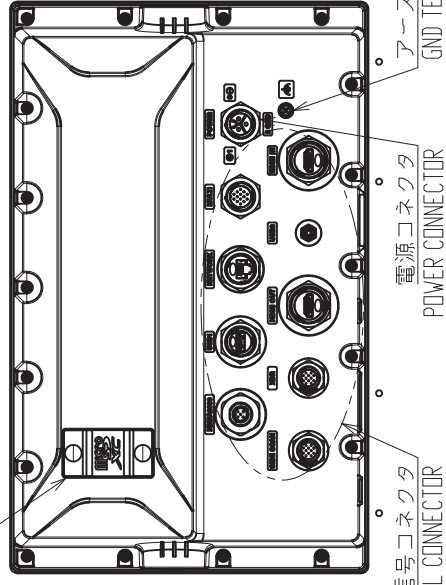

信号コネクタ  
SIGNAL CONNECTOR

電源コネクタ  
POWER CONNECTOR

アース端子  
GND TERMINAL

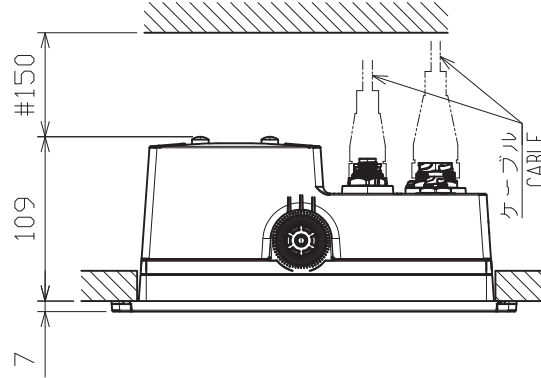

ケーブル  
CABLE

NOTE

1. TABLE 1 INDICATES TOLERANCE OF DIMENSIONS WHICH IS NOT SPECIFIED.
2. # MINIMUM SERVICE CLEARANCE.
3. USE TAPPING SCREWS φ4x20 FOR FIXING THE UNIT.

DRAWN	23/Jan/2024 S.HAN	TITLE	TZT16X
CHECKED	23/Jan/2024 T.YAMASAKI	名称	マルチファンクションディスプレイ (埋込装備1)
APPROVED	19/Feb/2024 H.MAKI	外寸図	
SCALE	1/5	重量はケーブルを含み MASS DOES NOT INCLUDE CABLE.	
DWG. No.	C4528-G01-A	REF. No.	19-036-120G-1
		NAME	MULTI FUNCTION DISPLAY (FLUSH MOUNT 1)
		OUTLINE DRAWING	

表1 TABLE 1

寸法区分 (mm) DIMENSION	公差 (mm) TOLERANCE
L ≤ 50	±1.5
50 < L ≤ 100	±2.5
100 < L ≤ 500	±3
500 < L ≤ 1000	±4

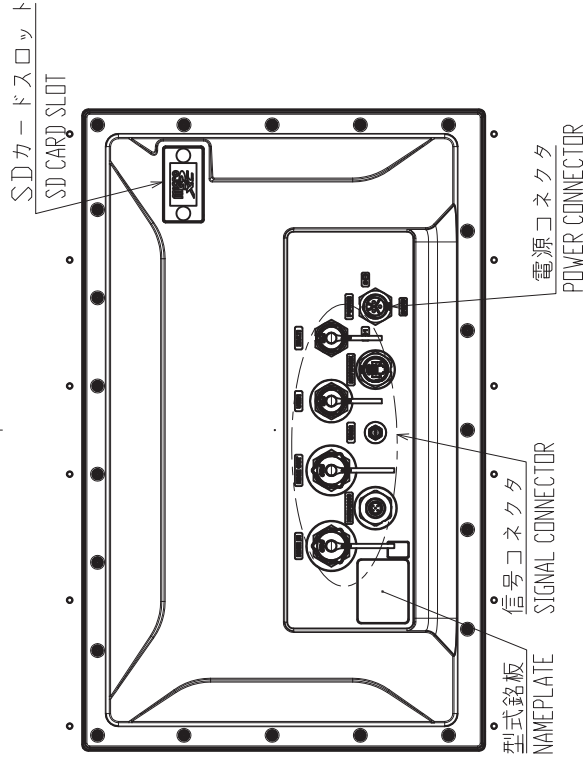
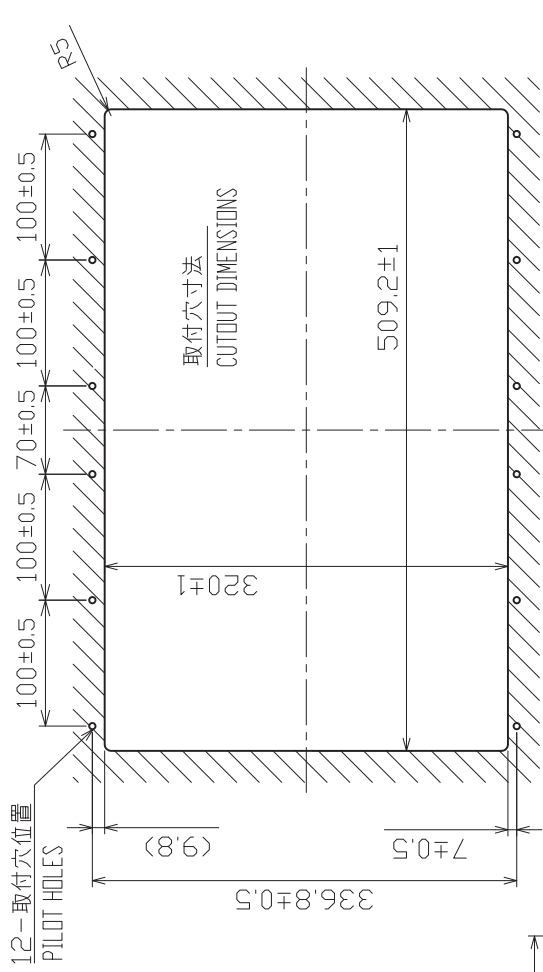
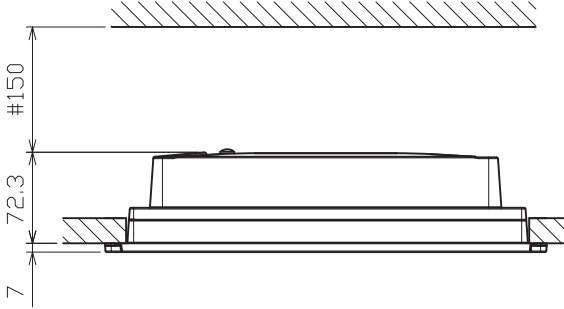
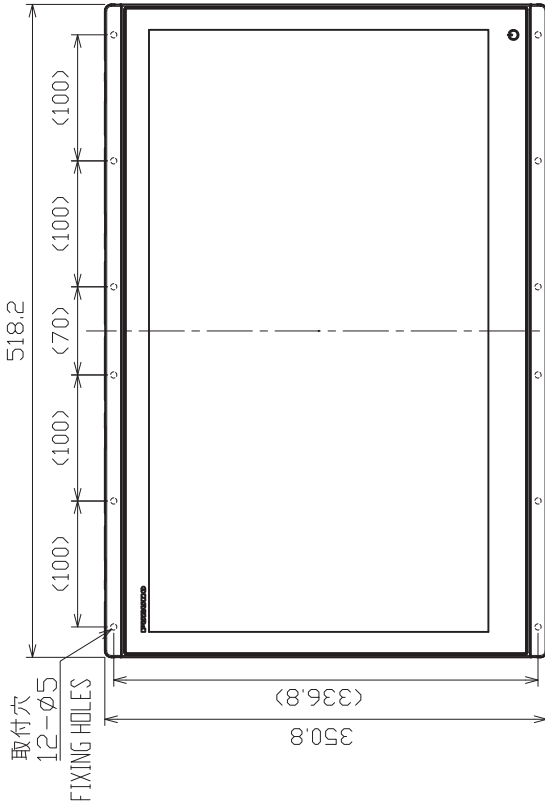

- 注 記
- 1) 指定外の寸法公差は表 1 による。
  - 2) #印寸法は最小サービス空間寸法とする。
  - 3) 取付用ネジはバインドットタッピング呼び径 4×2.0 を使用のこと。
- NOTE
1. TABLE 1 INDICATES TOLERANCE OF DIMENSIONS WHICH IS NOT SPECIFIED.
  2. # MINIMUM SERVICE CLEARANCE.
  3. USE TAPPING SCREWS Ø4x2.0 FOR FIXING THE UNIT.

DRAWN	11/Dec/2023	I. YAMASAKI	TITLE	TZT22X
CHECKED	11/Dec/2023	H. MAKI	名称	マルチファンクションディスプレイ (埋込装備1)
APPROVED	22/Jan/2024	H. MAKI	外寸図	
SCALE	1/6	1/6	NAME	MULTI FUNCTION DISPLAY (FLUSH MOUNT 1)
DWG. No.	C4523-001-B	REF. No.	19-036-130G-1	OUTLINE DRAWING

表1 TABLE 1

寸法区分 (mm) DIMENSION	公差 (mm) TOLERANCE
L ≤ 50	±1.5
50 < L ≤ 100	±2.5
100 < L ≤ 500	±3
500 < L ≤ 1000	±4

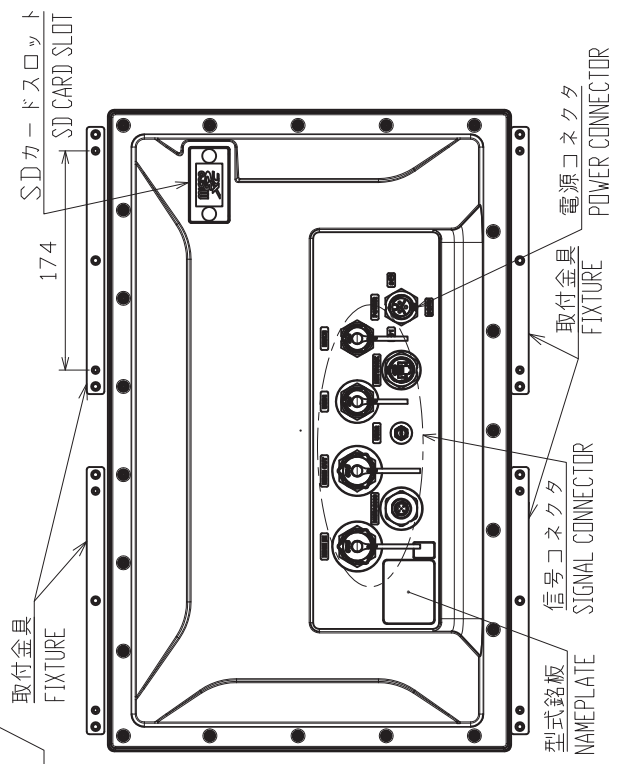
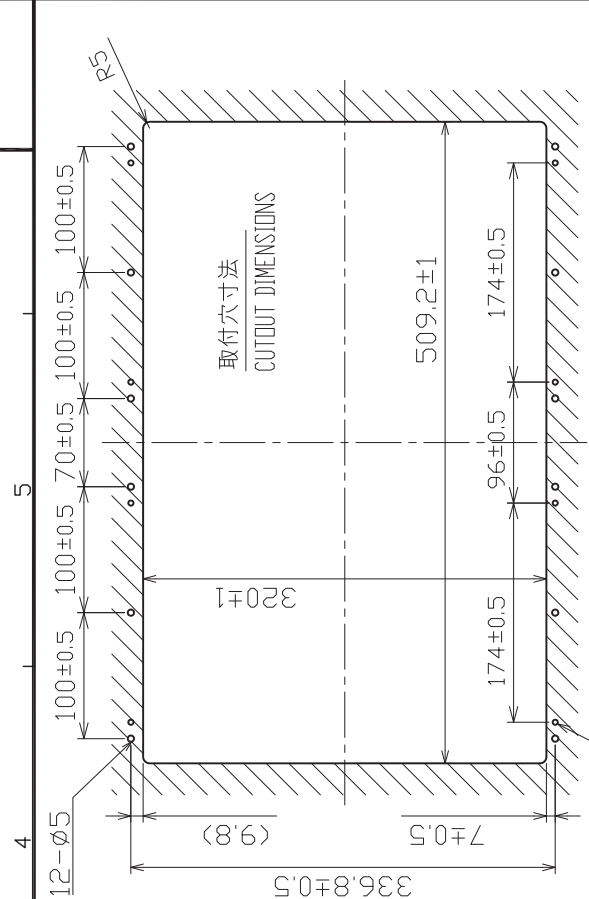
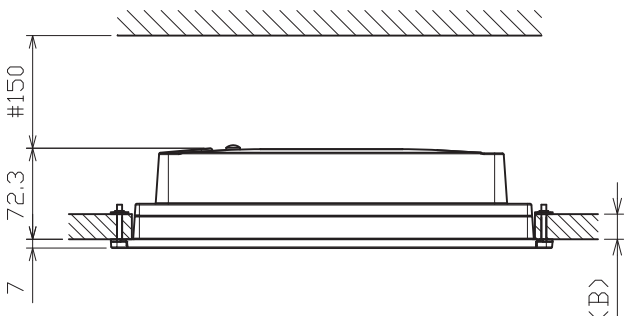
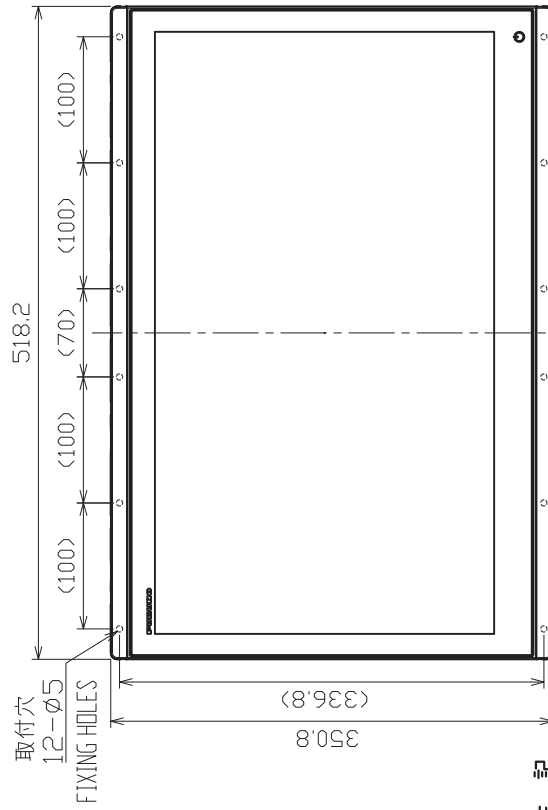
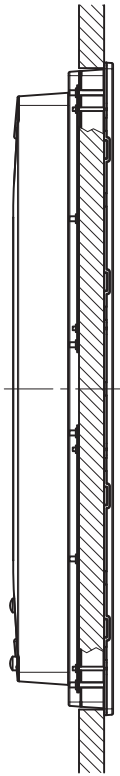

注 記  
 1) 指定外の寸法公差は表1による。  
 2) #印寸法は最小サージビス空間寸法とする。  
 3) 壁の厚さ(B)は最小5、最大20とする。  
 4) 取付金具はバインドネジM3×25、本体はバインドネジM4×30で固定する。

NOTE  
 1. TABLE 1 INDICATES TOLERANCE OF DIMENSIONS WHICH IS NOT SPECIFIED.  
 2. # MINIMUM SERVICE CLEARANCE.  
 3. BULKHEAD THICKNESS (B): 5≦B≦20.  
 4. USE BINDING SCREWS M3×25 FOR FIXING FIXTURES AND USE BINDING SCREWS M4×30 FOR FIXING THE UNIT.

DRAWN	11/Dec/2023	I.YAMASAKI	TITLE	TZ122X
CHECKED	11/Dec/2023	H.MAKI	名称	マルチファンクションディスプレイ (埋込装備2)
APPROVED	22/Jan/2024	H.MAKI	外寸図	
SCALE	1/6	MASS 5.7 kg	NAME	MULTI FUNCTION DISPLAY (FLUSH MOUNT 2)
DWG.No.	C4523-002-B	REF.No.	19-036-131G-1	OUTLINE DRAWING

表1 TABLE 1

寸法区分 (mm) DIMENSION	公差 (mm) TOLERANCE
L ≤ 50	±1.5
50 < L ≤ 100	±2.5
100 < L ≤ 500	±3
500 < L ≤ 1000	±4

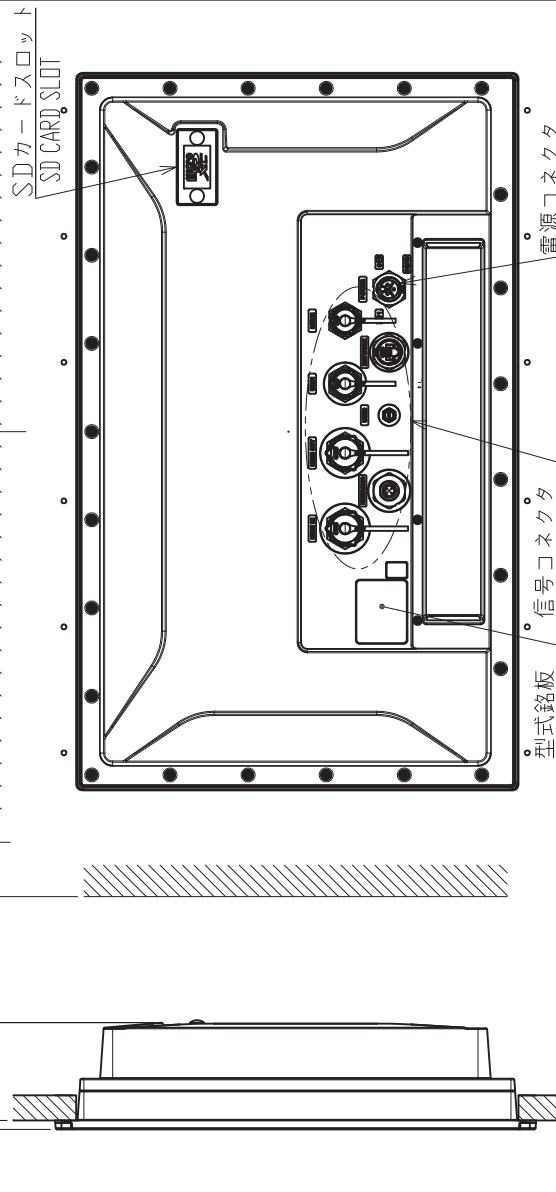
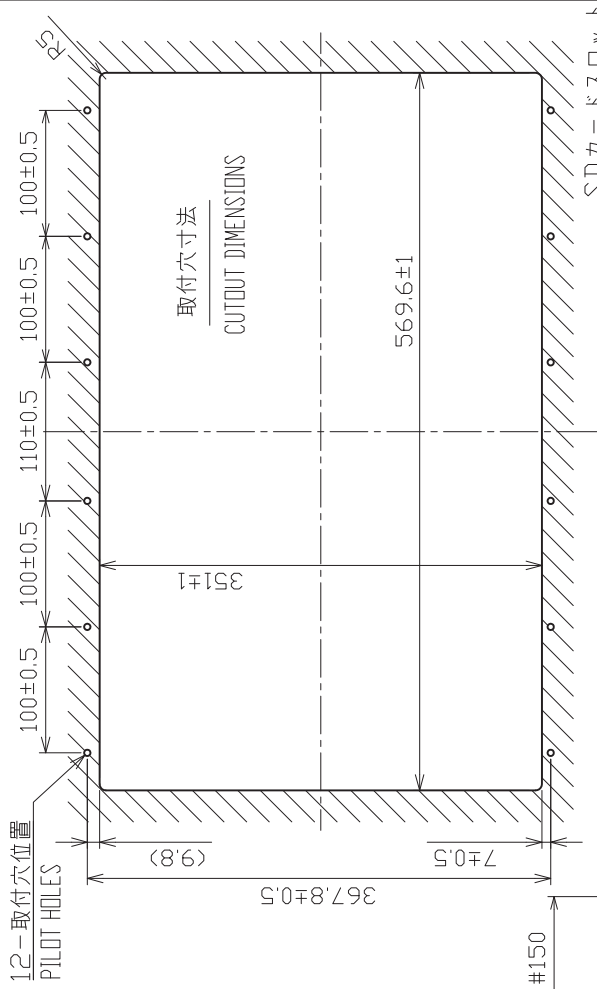
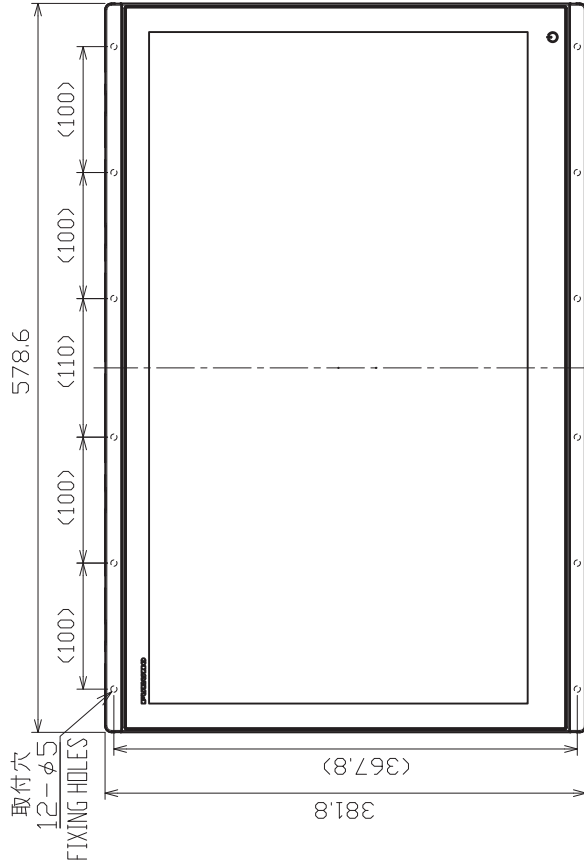
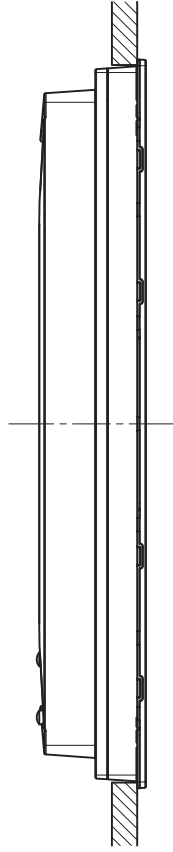

DRAWN	11/Dec/2023	T.YAMASAKI	TITLE	TZT24X
CHECKED	11/Dec/2023	H.MAKI	名称	マルチファンクションディスプレイ (埋込装備1)
APPROVED	22/Jan/2023	H.MAKI	外寸図	
SCALE	1/6	MASS 8.0 100g kg	NAME	MULTI FUNCTION DISPLAY (FLUSH MOUNT 1)
DWG.No.	C4524-501-B	REF.No.	19-036-140G-2	OUTLINE DRAWING

注記  
 1) 指定なき寸法公差は表1による。  
 2) #印寸法は最小サービスイ隙寸法とする。  
 3) 取付にはバインドットピンネジ呼び径4×2.0を使用のこと。

NOTE  
 1. TABLE 1 INDICATES TOLERANCE OF DIMENSIONS WHICH IS NOT SPECIFIED.  
 2. # MINIMUM SERVICE CLEARANCE.  
 3. USE TAPPING SCREWS φ4×2.0 FOR FIXING THE UNIT.

表1 TABLE 1

寸法区分 (mm) DIMENSION	公差 (mm) TOLERANCE
L ≤ 50	±1.5
50 < L ≤ 100	±2.5
100 < L ≤ 500	±3
500 < L ≤ 1000	±4

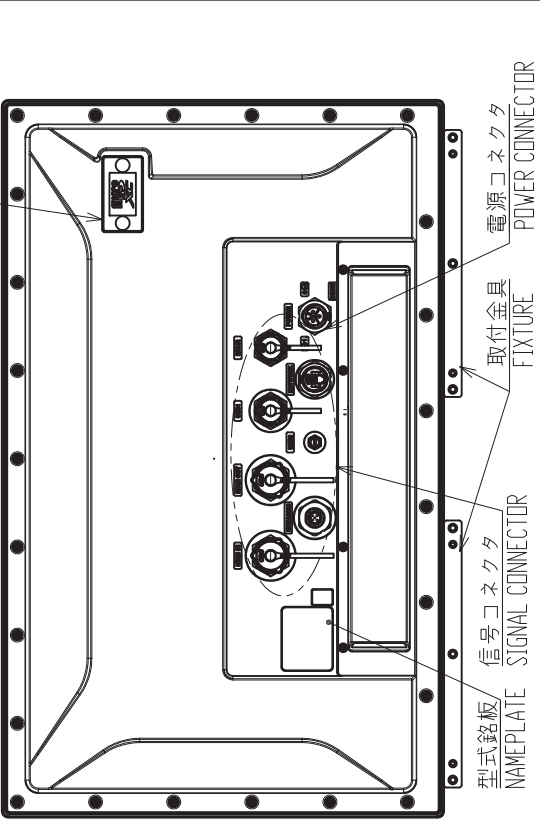
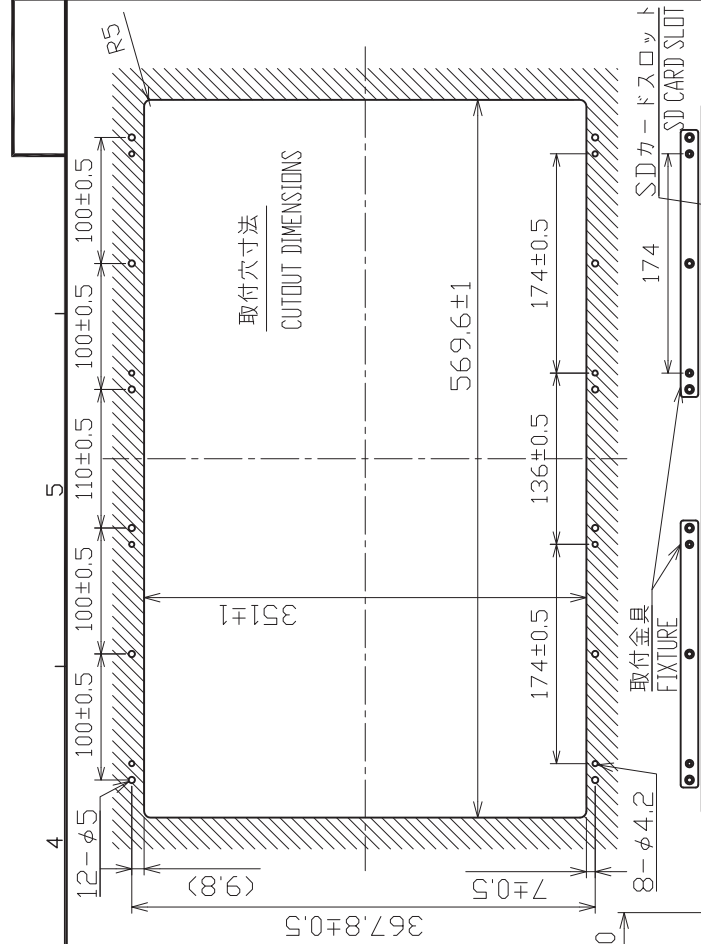
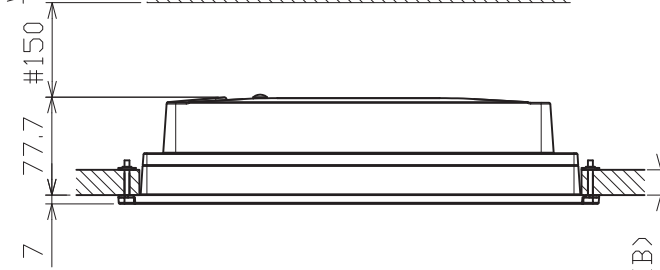
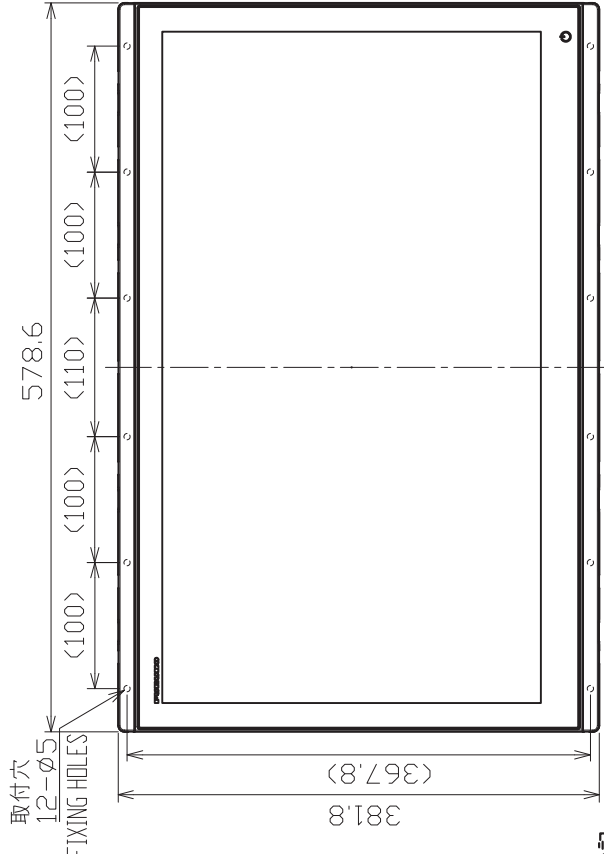
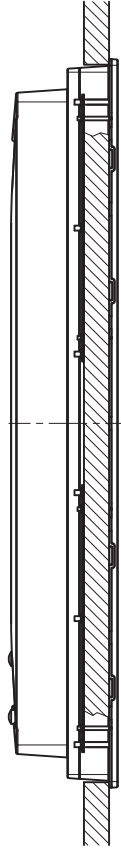

注記  
 1) 指定なき寸法公差は表1による。  
 2) #印寸法は最小サービス空間寸法とする。  
 3) 壁の厚さ(B)は最小5、最大20とする。  
 4) 取付金具はバインドネジM3×25、本体はバインドネジM4×30で固定する。

NOTE  
 1. TABLE 1 INDICATES TOLERANCE OF DIMENSIONS WHICH IS NOT SPECIFIED.  
 2. # MINIMUM SERVICE CLEARANCE.  
 3. BULKHEAD THICKNESS (B): 5 ≤ B ≤ 20.  
 4. USE BINDING SCREWS M3×25 FOR FIXING FIXTURES AND BINDING SCREWS M4×30 FOR FIXING THE UNIT.

DRAWN	11/Dec/2023	T.YAMASAKI	TITLE	TZT24X
CHECKED	11/Dec/2023	H.MAKI	名称	マルチファンクションディスプレイ (埋込装備2)
APPROVED	22/Jan/2024	H.MAKI	外寸図	
SCALE	1/6	MASS 8.1 100% kg	NAME	MULTI FUNCTION DISPLAY (FLUSH MOUNT 2)
DWG.No.	C4524-G02-B	REF.No.	16-036-141G-1	OUTLINE DRAWING

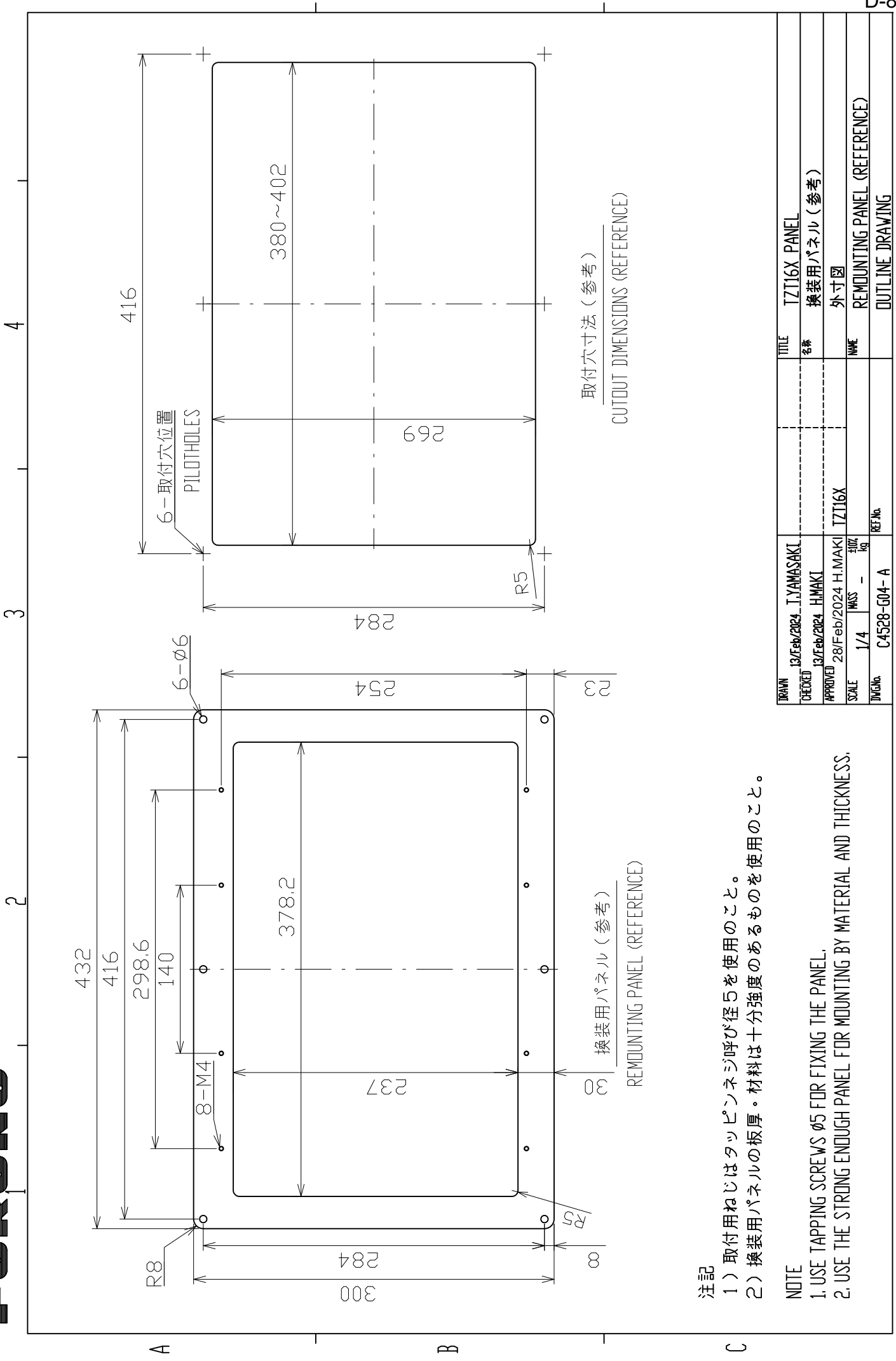

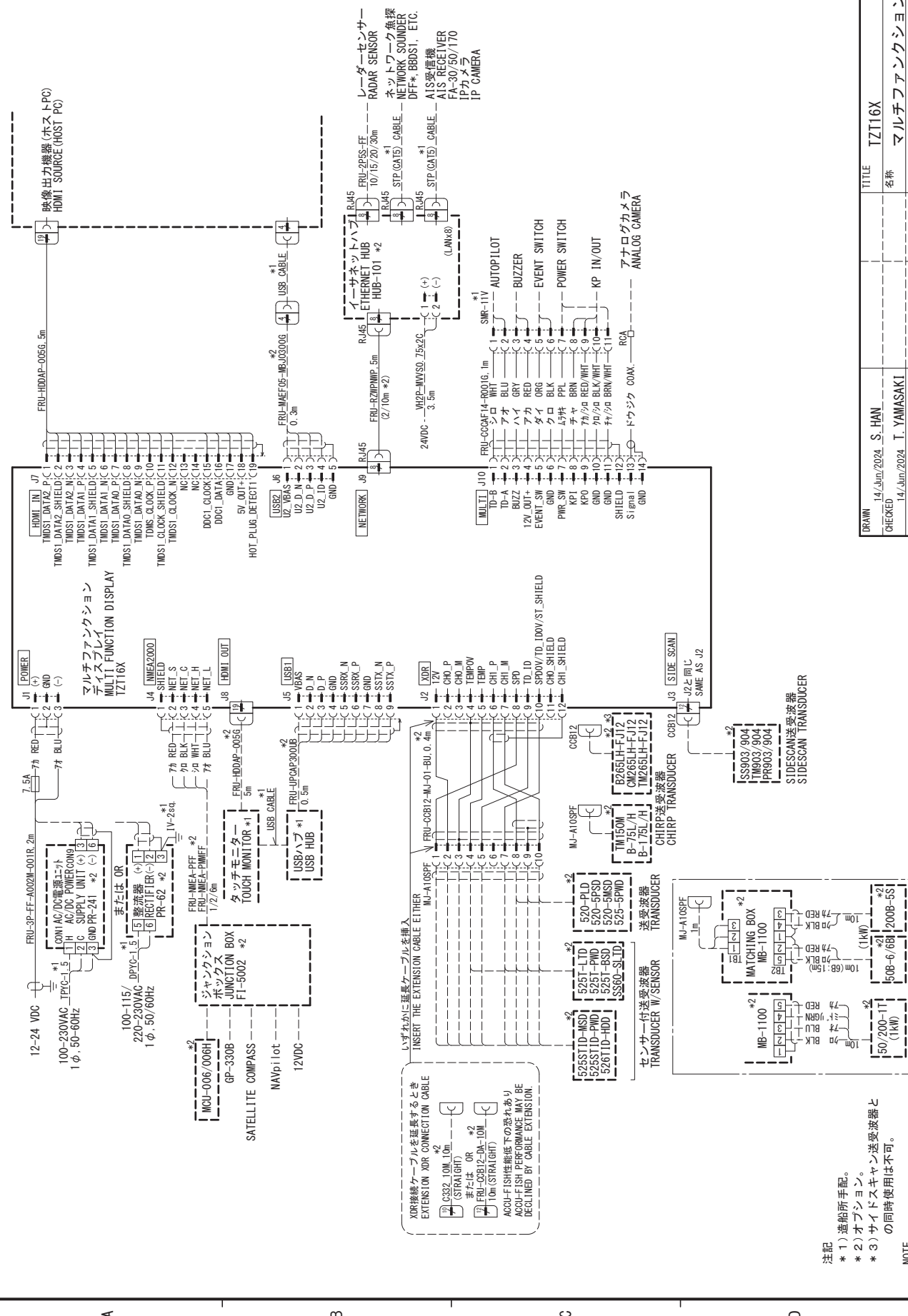

**注記**  
 \*1) 造船所手配。  
 \*2) オプション。  
 \*3) サイドスキャン送受波器との同時使用は不可。

**NOTE**  
 \*1: SHIPYARD SUPPLY.  
 \*2: OPTION.  
 \*3: DO NOT USE WITH SIDESCAN TRANSDUCER SIMULTANEOUSLY.

DRAWN	14/Jun/2024	S. HAN	TITLE	TZ116X
CHECKED	14/Jun/2024	T. YAMASAKI	名称	マルチファンクションディスプレイ
APPROVED	28/Jun/2024	A. Murae	相互結線図	
SCALE		1/ASS	NAME	MULTI FUNCTION DISPLAY
DWG No.		C4528-C01-B	REF. No.	INTERCONNECTION DIAGRAM



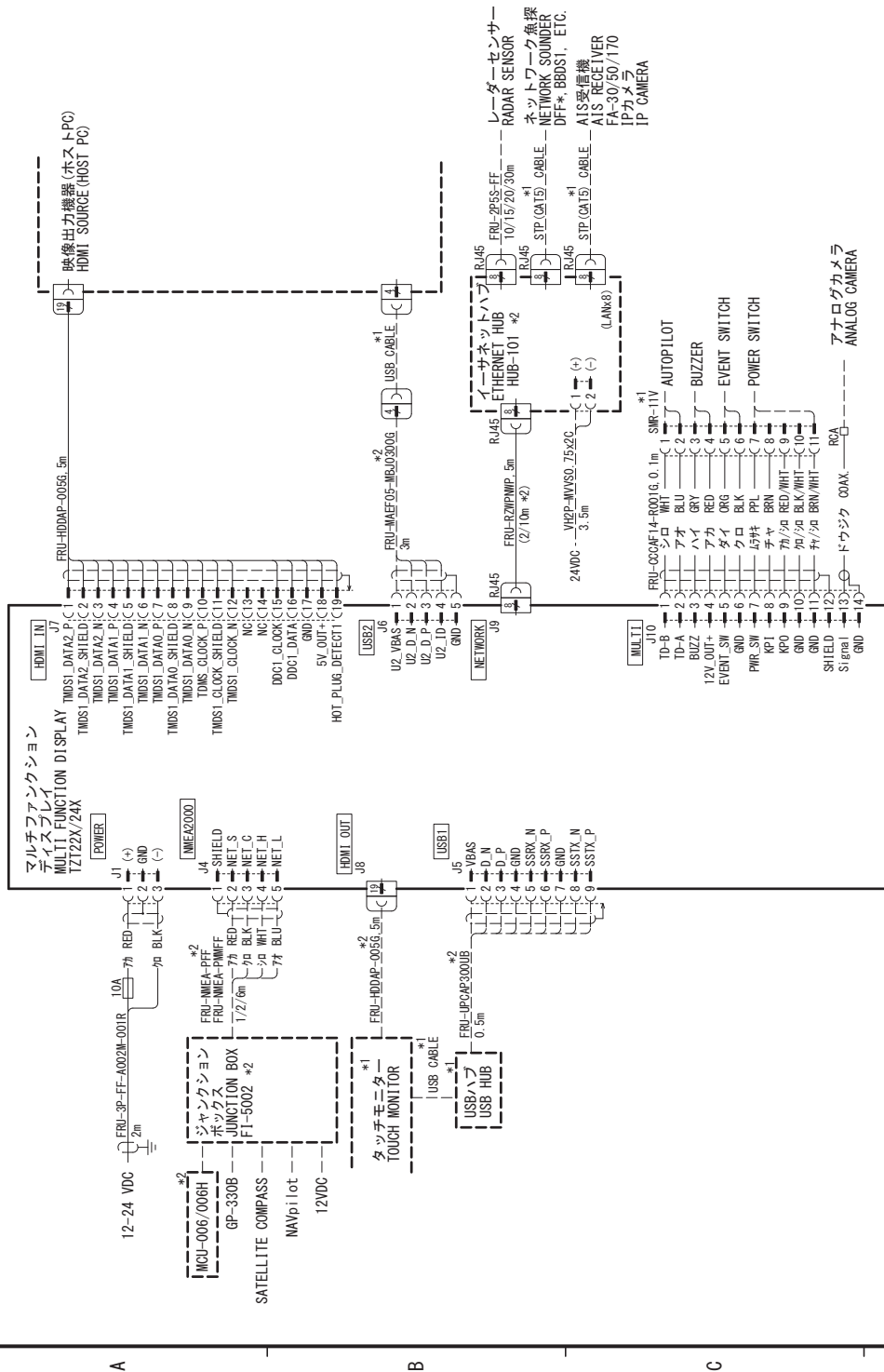

注記  
\*1) 造船所手配。  
\*2) オプション。

NOTE  
\*1: SHIPYARD SUPPLY.  
\*2: OPTION.

DRAWN	17/Jhd/2024	S. HAN	TITLE	TZT22X/24X
CHECKED	17/Jhd/2024	T. YAMASAKI	名称	マルチファンクションディスプレイ
APPROVED	28/Jun/2024	A. Murae	相互接続図	
SCALE	1/ASS	kg	NAME	MULTI FUNCTION DISPLAY
DWG No.	C4523-C01-E		INTERCONNECTION DIAGRAM	
			REF. No.	