

Installation Manual

AUTOPILOT

Model NAVpilot-300

SAFETY INSTRUCTIONS	i
SYSTEM CONFIGURATION	iii
EQUIPMENT LISTS	iv
1. MOUNTING	1-1
1.1 Control Unit.....	1-1
1.2 Processor Unit	1-5
1.3 Rudder Reference Unit (Option)	1-8
2. WIRING	2-1
2.1 Processor Unit	2-3
2.2 Control Unit.....	2-5
2.3 Junction Box (Option)	2-6
2.4 Input/Output PGNs.....	2-8
3. INITIAL SETTING	3-1
3.1 [Initialization] Menu	3-1
3.2 [Display Setup] Menu.....	3-3
3.3 [Ship's Characteristics] Menu	3-3
3.4 [Dockside Setup] Menu.....	3-5
3.5 [NMEA2000] Menu.....	3-18
3.6 [Drive by Wire Port] Menu.....	3-19
3.7 [Sensors Selection] Menu	3-19
3.8 [Sea Trial] Menu.....	3-20
3.9 [Parameter Setup] Menu.....	3-23
3.10 [Auto Pilot Option] Menu	3-26
3.11 [Fish Hunter Option] Menu.....	3-27
3.12 [System Setup] Menu.....	3-31
3.13 Pairing the Gesture Controller ([Wireless RC] Menu).....	3-33
3.14 [Alert] Menu.....	3-34
APPX. 1 JIS CABLE GUIDE	AP-1
PACKING LIST(S)	A-1
OUTLINE DRAWING(S)	D-1
INTERCONNECTION DIAGRAM(S)	S-1

**FURUNO ELECTRIC CO., LTD.**www.furuno.com

All brand and product names are trademarks, registered trademarks or service marks of their respective holders.

ECF

(Elemental Chlorine Free)

The paper used in this manual
is elemental chlorine free.

FURUNO ELECTRIC CO., LTD.

9-52 Ashihara-cho,
Nishinomiya, 662-8580, JAPAN

• FURUNO Authorized Distributor/Dealer

All rights reserved. Printed in Japan

Pub. No. IME-72840-D1

(TEHI) NAVpilot-300

A : OCT. 2017

D1 : AUG. 17, 2022





0 0 0 1 9 3 2 9 6 1 3









SAFETY INSTRUCTIONS

The installer must read the appropriate safety instructions before attempting to install the equipment.



Note: For Gesture Controller (GC-001) safety instructions, see the User's Guide (C72-01603).

 WARNING	Indicates a condition that can cause death or serious injury if not avoided.
 CAUTION	Indicates a condition that can cause minor or moderate injury if not avoided.

 Prohibitive Action	 Warning, Caution	 Mandatory Action
--	--	--

 WARNING	
	<p>ELECTRICAL SHOCK HAZARD Do not open the equipment unless totally familiar with electrical circuits and service manual.</p> <p>Only qualified personnel are allowed to work inside the equipment. For the serviceman: Make sure the waterproofing gasket is correctly seated in the groove in the chassis before closing the cover.</p>
	<p>Do not allow unit to be wet by waves, spray or heavy rain in inclement weather.</p> <p>Electrical fire and/or electrical shock can result.</p>
	<p>Turn off the power at the mains switchboard before beginning the installation.</p> <p>Fire, electrical shock or serious injury can result if the power is left on or is applied while the equipment is being installed.</p>
	<p>When connecting a geomagnetism detection type heading sensor, correct magnetic field deviation.</p> <p>If an autopilot is used without the compensation, unexpected course change may occur.</p>
	<p>Confirm that no one is near the rudder when bleeding air from oil cylinder.</p> <p>The rudder may move unexpectedly, possibly causing bodily injury.</p>
	<p>Input the correct ship's speed data.</p> <p>The NAVpilot cannot control the rudder properly, if the incorrect ship's speed is input.</p>

 WARNING	
	<p>Install an control unit (or emergency stop button) at each helm station, to allow you to disable the autopilot in an emergency.</p> <p>If the autopilot cannot be disabled, accidents may result.</p>

 CAUTION	
	<p>Confirm that the power supply voltage is compatible with the voltage rating of the equipment.</p> <p>Connection to the wrong power supply can cause fire or damage the equipment.</p>

	<p>Observe the following compass safe distances to prevent interference to a magnetic compass:</p>	
	Standard compass	Steering compass
Control Unit FAP-3011	0.55 m	0.35 m
Processor Unit FAP-3012	0.30 m	0.30 m

	<p>Separate the reversible pump at least one meter from communications equipment, communications antenna and communications cabling to prevent interference.</p>
---	---

Notice for the FishHunter™ Drive

The FishHunter Drive™ is intended to operate as a navigational aid. Depending on sea and sensor conditions, the vessel may move unexpectedly.

Do not rely solely on this function while navigating.

When using this function, the customer is responsible for making decisions based on the following precautions.

- Be sure to check the safety of your surroundings before using this function.
- The propeller may rotate at any time. Therefore, keep well away from the propeller when in the water, and when getting in or out of the water. To prevent bodily injury or even death, observe the following:
 - 1) It is very dangerous to be in the water near the hull. Keep well clear of the hull.
 - 2) The hull can suddenly move in any direction, so take care not to fall overboard.
- Read the operator's manual carefully to ensure safe use.

To prevent possible bodily injury, attach the warning labels(FP64-01601, 001-634-970) supplied with the control unit (FAP-3011), near the control unit and in places easily noticeable (two in total), such as near the swim steps or the ladder (see "Attaching position" in below).

Attaching position

NOTICE
<p>When attaching warning labels, observe the following:</p> <ul style="list-style-type: none">• Organic solvents and anti-corrosive sealants should be wiped off before attaching.• No organic solvents or anti-corrosive sealants should adhere to the label.• Labels should be attached on a flat, smooth surface.

Attach the labels to A and B or C as shown below.

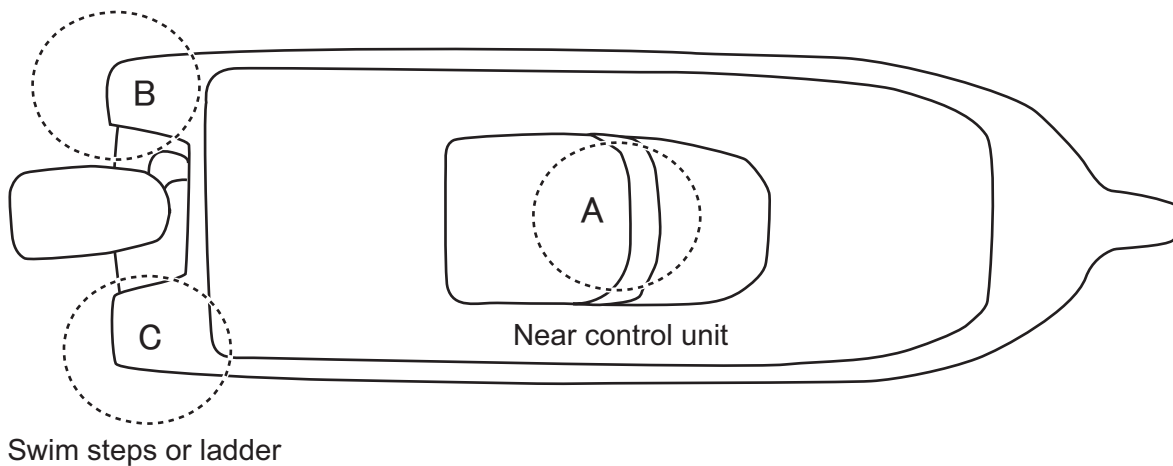

SYSTEM CONFIGURATION

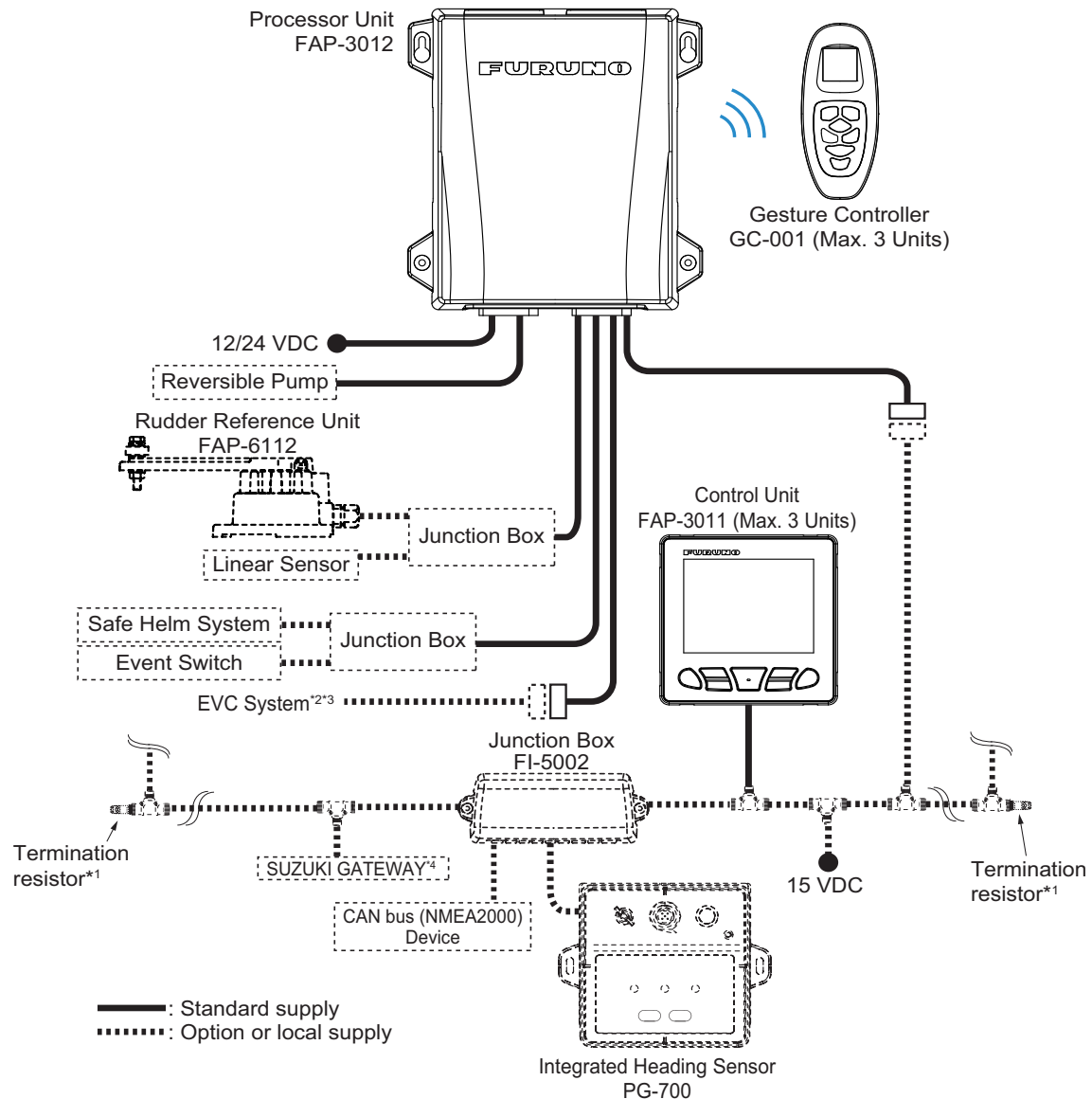

*1: Termination resistors must be installed at both ends of the backbone.

*2: EVC systems compatible with the NAVpilot are as follows:

EVC System	Remarks
VOLVO PENTA IPS	Requires VOLVO IPS gateway (available as an optional extra).
YAMAHA Helm Master	Requires YAMAHA HM gateway (available as an optional extra).
YANMAR VC10	-
Dometic Optimus	The software version of the Main PCM (Pump Control Module) must be "Rev. T" or later.

*3: Dometic Optimus is only available when using the SUZUKI Gateway.

*4: Below equipment is required to use FishHunter™ Drive.

Equipment	Compatible model
Throttle	67200-98L00, 98L10, 98L20
Outboards	DF140BG/115BG, DF150AP/DF200AP/175AP, DF300AP/250AP, DF350A/325A/300B
Gateway	34923-96L12 (34923-96L10, 96L11 is available with updating the software)
BCM	36770-98L01

EQUIPMENT LISTS

Standard supply

Name	Type	Code No.	Qty	Remarks
Control Unit	FAP-3011	-	1	
Processor Unit	FAP-3012	-	1	
Gesture Controller	GC-001	-	1	May or may not be supplied depending on order.
Installation Materials	CP64-03400	001-472-360	1	For control unit
	CP64-02501	009-000-880	1	For processor unit
Accessories	FP64-01501	001-482-130	1	Batteries for GC-001
Spare Parts	SP64-01701	001-485-540	1	For processor unit, fuse

Option

Name	Type	Code No.	Remarks
Control Unit	FAP-3011	-	
Gesture Controller	GC-001	-	
Junction Box	FI-5002	-	For CAN bus connection
Rudder Reference Unit	FAP-6112-200	-	
VOLVO IPS Gateway	AUTOPILOT-GATEWAY	-	For VOLVO PENTA IPS system connection
YAMAHA HM Gateway	YAMAHA-HM-GATEWAY	-	For YAMAHA Helm Master system connection
SUZUKI Gateway	SUZUKI GATEWAY	-	For SUZUKI system connection.
Bracket Kit	OP64-13	000-033-337	For control unit

Name	Type	Code No.	Remarks
Cable Assembly	FI-70-0600	001-490-200	With micro type connectors (one side: L-type connector), 6 m
	M12-05BM+05BF-010	001-105-750-10	With micro type connectors, 1 m
	M12-05BM+05BF-020	001-105-760-10	With micro type connectors, 2 m
	M12-05BM+05BF-060	001-105-770-10	With micro type connectors, 6 m
	M12-05BFFM-010	001-105-780-10	With micro type connector, 1 m
	M12-05BFFM-020	001-105-790-10	With micro type connector, 2 m
	M12-05BFFM-060	001-105-800-10	With micro type connector, 6 m
	CB-05PM+05BF-010	000-167-968-11	With mini type connectors, 1 m
	CB-05PM+05BF-020	000-167-969-11	With mini type connectors, 2 m
	CB-05PM+05BF-060	000-167-970-11	With mini type connectors, 6 m
	CB-05BFFM-010	000-167-971-11	With mini type connector, 1 m
	CB-05BFFM-020	000-167-972-11	With mini type connector, 2 m
Cable Assembly	CB-05BFFM-060	000-167-973-11	With mini type connector, 6 m
Micro T-Connector	SS-050505-FMF-TS001	000-168-603-10	
Mini/Micro T-Connector	NC-050505-FMF-TS001	000-160-507-10	
Termination Resistor (Micro)	LTWMC-05BMMT-SL8001	000-168-604-10	Male
	LTWMC-05BFFT-SL8001	000-168-605-10	Female
Termination Resistor (Mini)	LTWMN-05AMMT-SL8001	000-160-508-10	Male
	LTWMN-05AFFT-SL8001	000-160-509-10	Female

This page is intentionally left blank.

1. MOUNTING

The NAVpilot-300 is design for use in 20 ft or larger boats with inboard, outboard, in/outboard engines or DBW engines^{*,**}.

The installer of this equipment must be familiar with the hydraulic system and have the experience of installing the ship's steering equipment.

*: DBW (Drive By Wire) systems compatible with the NAVpilot-300 are as follows:

- VOLVO PENTA IPS
- YAMAHA Helm Master
- YANMAR VC10
- Dometic Optimus
(The software version of the Main PCM (Pump Control Module) must be "Rev. T" or later.)

**.: FishHunter™ Drive is only available for outboard engines.

NOTICE

Do not apply paint, anti-corrosive sealant or contact spray to coating or plastic parts of the equipment.

Those items contain organic solvents that can damage coating and plastic parts, especially plastic connectors.

1.1 Control Unit

The control unit can be installed with one the following three methods:

- Flush mount: Secured from the rear side of the mounting hole.
- Front mount: Secured from the front side of the mounting hole.
- Desktop mount: Requires optional bracket kit (OP64-13). For desktop mount installation instructions, see the installation instruction (C72-01605) supplied with bracket kit.

Mounting consideration

Select a mounting location, keeping in mind the following points:

- Select a location where the unit can easily be operated.
- Do not install the unit under "Plexiglas" or other types of shielding material. Plexiglas can trap heat and moisture or magnify sunlight on the surface of the display.
- Locate the unit away from exhaust pipes and ventilators.
- The mounting location should be well ventilated.
- Select a location where shock and vibration are minimal.
- Leave sufficient space for maintenance and service, referring to the outline drawings at the back of this manual.

1. MOUNTING

- Select a mounting location considering the length of the cables to be connected to the unit.
- A magnetic compass will be affected if the unit is placed too close to the magnetic compass. Observe the compass safe distances at the front of this manual to prevent interference to a magnetic compass.

1.1.1 Flush mount

Supplied installation materials

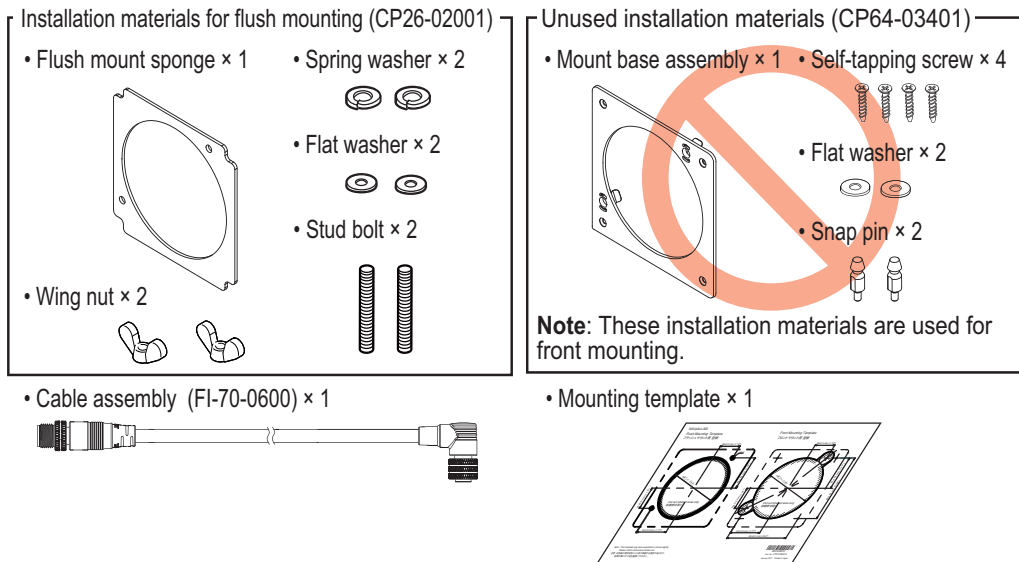

Required tools

The following tools should be prepared in advance for this installation.

Name	Remarks
Electrical Drill	For making the bolt holes for threaded rods.
Drill Bit	φ3.5
Tank Cutter	For making the mounting hole (φ90 mm).
File	For smoothing the cut edge of the mounting hole.

1. Make a mounting hole in the mounting location and two bolt holes for the threaded rods, using the supplied mounting template.
Note: Be sure to use “Flush Mounting Template”.
2. Fit the supplied threaded rods (M3×40) to the rear of the unit.
Note: Do not use tools to fit or insert the threaded rods.
3. Fit the supplied flush mount sponge to the rear of the unit.
4. Feed the cable through the mounting hole, then connect the cable to the unit.
5. Set the unit into the mounting hole.

- Fit the supplied flat washers, spring washers and wing nuts to the threaded rod, then fasten the wing nuts to secure the unit.

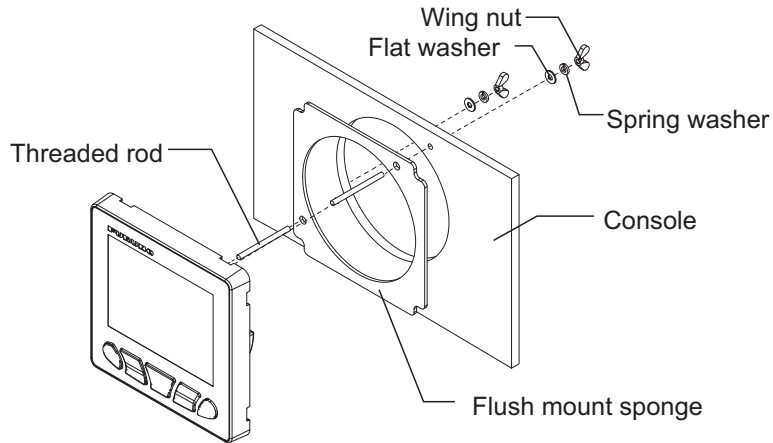

When using locally supplied materials

When using locally supplied screws to secure the control unit, thread depth should be approx. 5 mm, as indicated in the figure to the right.

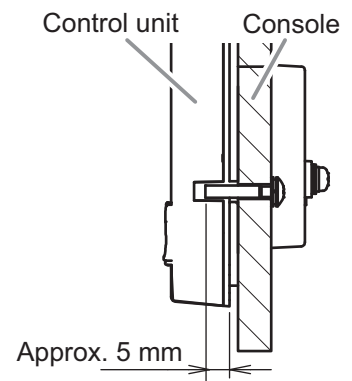

1.1.2 Front mount

Supplied installation materials

Installation materials for front mounting (CP64-03401)

- Mount base assembly × 1
- Self-tapping screw × 4
- Flat washer × 2
- Snap pin × 2

- Cable assembly (FI-70-0600) × 1

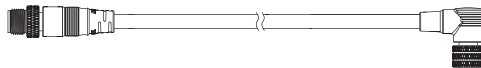

- Mounting template × 1

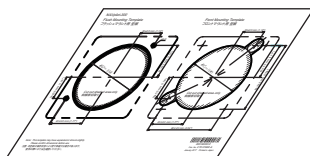

Unused installation materials (CP26-02001)

- Flush mount sponge × 1
- Spring washer × 2
- Flat washer × 2
- Stud bolt × 2
- Wing nut × 2

Note: These installation materials are used for flush mounting.

1. MOUNTING

Required tools

The following tools should be prepared in advance for this installation.

Name	Remarks
Electrical Drill	For making the pilot holes for self-tapping screws.
Drill Bit	φ2.5
Tank Cutter	For making the mounting hole (φ90 mm).
Hole Saw (φ19 mm)	For making holes for the snap pin slot.
File	For smoothing the cut edge of the mounting hole.
Phillips-head Screw Driver	#2

1. Make a mounting hole in the mounting location and four pilot holes for the self-tapping screws, using the supplied mounting template.

Note: Be sure to use “Front Mounting Template”.

2. Insert the supplied flat washers and snap pins to the rear of the unit.

3. Secure the supplied mount base assembly to the mounting hole, using the supplied self-tapping screws (φ3×20).

Note: Check that the mount base assembly is oriented in the correct manner, referring to the figure to the right.

4. Feed the cable through the mounting hole, then connect the cable to the unit.

5. Set the control unit into the mount base assembly, using the snap pins and snap pin slots as guides.

Push the unit into the mount base assembly until a “click” sound is made, indicating that the unit is now secured.

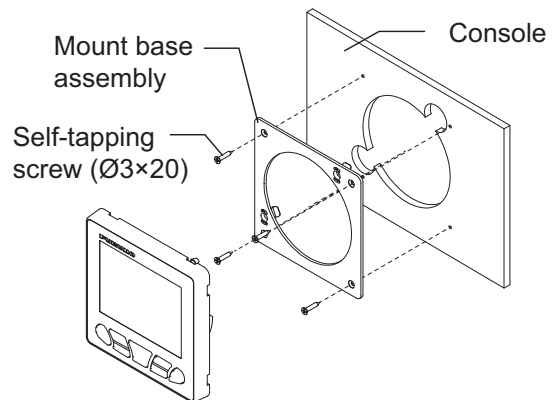
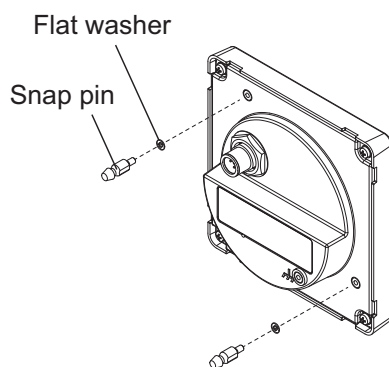
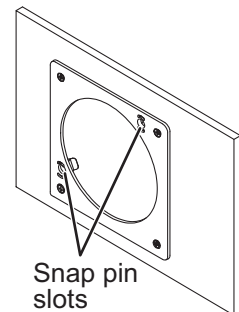

How to remove a front mounted control unit

To remove the control unit from the mount base assembly, release the pin holders at the back of the panel, then remove the unit. Forced removal may damage the pin holders, snap pins, mount base assembly or the control unit.

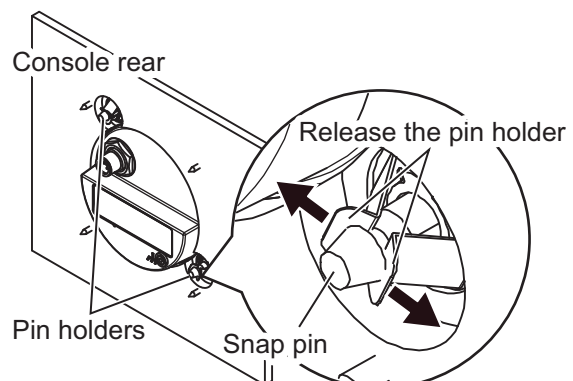

1.2 Processor Unit

The processor unit can be installed on a desktop or on a bulkhead.

Mounting consideration

Select a mounting location, keeping in mind the following points:

- Perform a communication test between the processor unit and gesture controller, **before** mounting the processor unit. For how to perform the communication test, see section 1.2.1.
- Do not install the unit in a metal shield body, which may obstruct communication with the gesture controller.
- Select a location where obstructions between the processor unit and gesture controller is minimal.
Obstructions between the processor unit and gesture controller reduce the communicable range.
- Select a location where the gesture controller is visible from the mounting location of the processor unit (ex. flying bridge).
- Locate the unit away from direct sunlight
- Locate the unit away from places subject to water splash and rain.
- Locate the unit away from exhaust pipes and ventilators.
- The mounting location should be well ventilated.
- Select a location where the shock and vibration are minimal.
- For the installation on a bulkhead, make sure the mounting location is strong enough to support the unit under the pitching and rolling normally found on the boat.
- Leave sufficient space for maintenance and service, referring to the outline drawings at the back of this manual.
- Select a mounting location considering the length of the cables to be connected to the unit.
- A magnetic compass will be affected if the unit is placed too close to the magnetic compass. Observe the compass safe distances at the front of this manual to prevent interference to a magnetic compass.
- For installation on a bulkhead, secure the unit so that the cables face downward.

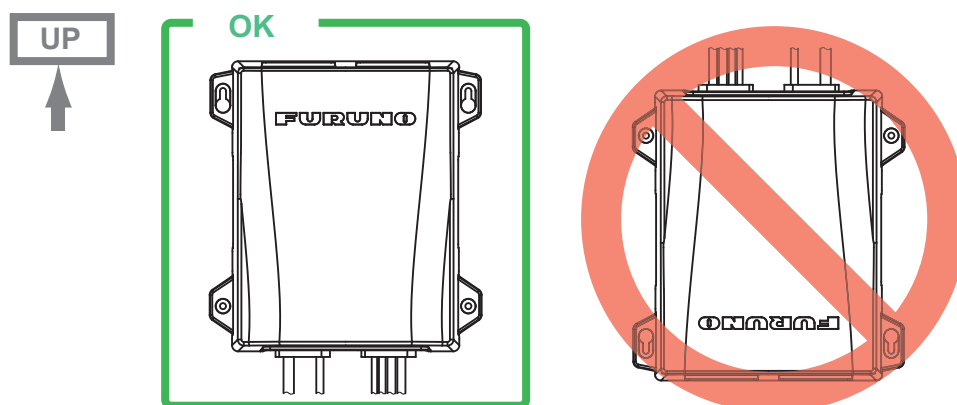

1. MOUNTING

1.2.1 Bluetooth® communication test before mounting

The processor unit communicates with the gesture controller via the Bluetooth® wireless technology*. Before mounting the unit, perform a communication test at the planned mounting location, to check that Bluetooth® communication is established correctly. If the Bluetooth communication is not established, change the mounting location and perform the communication test again.

*: The Bluetooth® word mark and logos are registered trademarks of Bluetooth SIG, Inc.

1. Connect the units referring to the following figure.

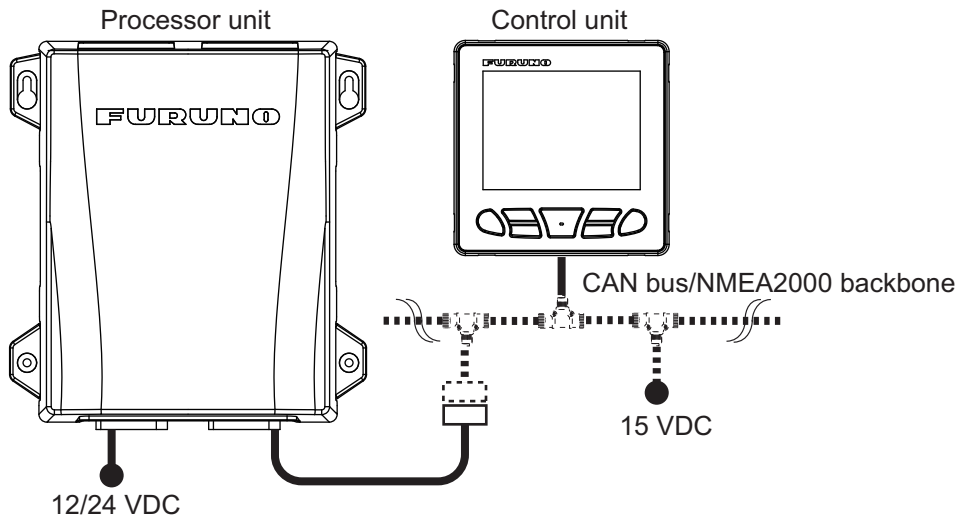

2. Turn on the processor unit, control unit and gesture controller.
3. Pair the gesture controller to the processor unit, referring to section 3.13.
4. Move to the location where you use the gesture controller.
5. Turn your back on the location where the processor unit is located. Your body should be located between the processor unit and gesture controller during the communication test.
6. Press the  on the gesture controller to open the menu, then select [SYSTEM MENU]→[DIAGNOSTIC]→[BT TEST].
7. Confirm the test result.

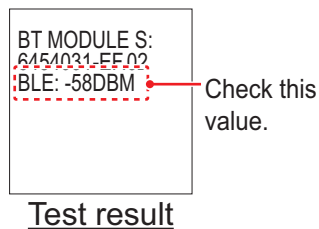

- When [BLE] is “-80 DBM” or higher, the communication is stable. The planned installation location for the processor unit is good.
- When [BLE] is lower than “-80 DBM”, the communication is unstable. In this case, the communication error is more likely to occur. Change the installation location and retry the communication test.

1.2.2 Mounting

Mount the unit on a bulkhead or desktop.

Supplied installation materials

- Self-tapping screw ×4



Required tools

The following tools should be prepared in advance for this installation.

Name	Remarks
Electrical Drill	For making the pilot holes for self-tapping screws.
Drill Bit	φ3.5
Phillips-head Screw Driver	#2

1. Drill four pilot holes in the bulkhead or desktop for self-tapping screws.
2. Screw two self-tapping screws (φ4×20) into the upper pilot holes, leave 5 mm protruding.
3. Hang (or set) the notches of the unit onto the screws fastened at step 2.
4. Screw two self-tapping screws (φ4×20) into the lower fixing holes.
5. Fasten all screws tightly to secure the unit in place.

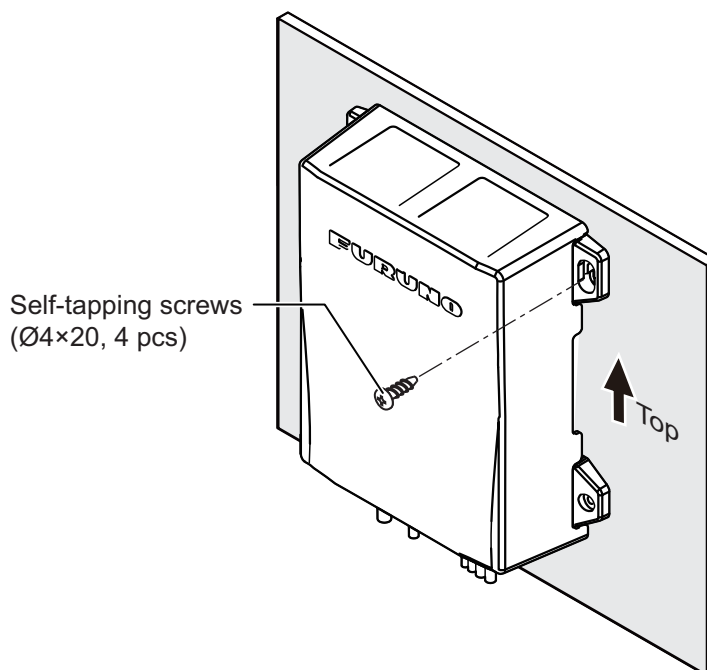

1.3 Rudder Reference Unit (Option)

Note 1: This unit is not required for Fantum Feedback™ and EVC system equipped boats. For details of Fantum Feedback™, see section 1.3.5.

Note 2: DOMETIC linear sensor AR4502 is available with the NAVpilot, instead of the rudder reference unit. For installation instructions, see the linear sensor operator's manual.

Mounting consideration





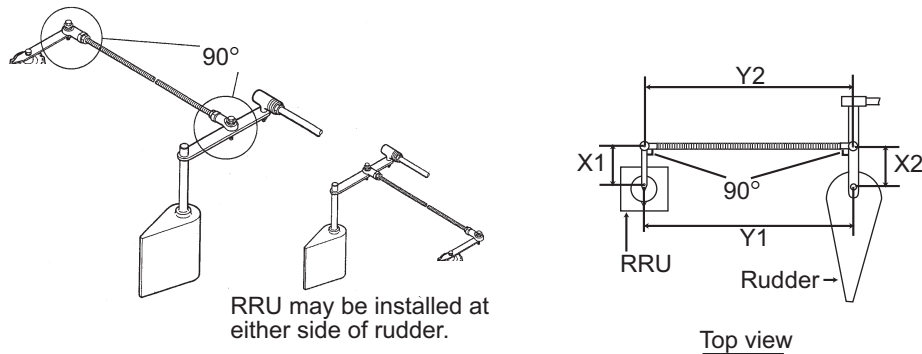

Select a mounting location, keeping in mind the following points:

- Leave sufficient space around all moving parts.
- The unit must be fastened to the rudder as shown below, where the following conditions are met:
 $350 \text{ mm (13.8")} < Y2 < 540 \text{ mm (21.3")}$
 $X1 = X2$
 $Y1 = Y2$

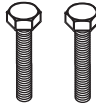

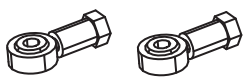
1.3.1 Mounting

Supplied installation materials

- | | | |
|---|---|---|
| • Connecting rod × 1 | • Hex. bolt × 2 | • Hex. nut × 4 |
|  |  |  |
| • Rod end bearing × 2 | • Flat washer × 6 | • Self-tapping screw × 3 |
|  |  |  |
| • Spacer × 1 | • Spring washer × 2 | |
|  |  | |

Required tools

The following tools should be prepared in advance for this installation.

Name	Remarks
Electrical Drill	For making the pilot holes for self-tapping screw.
Drill Bit	φ3.5
Phillips-head Screw Driver	#2
Wrench	For M6 (hex. size 10 mm)

Mount the RRU, referring to the following figure. Installation materials for mounting the RRU are supplied with the RRU. The RRU can be installed either side of rudder.

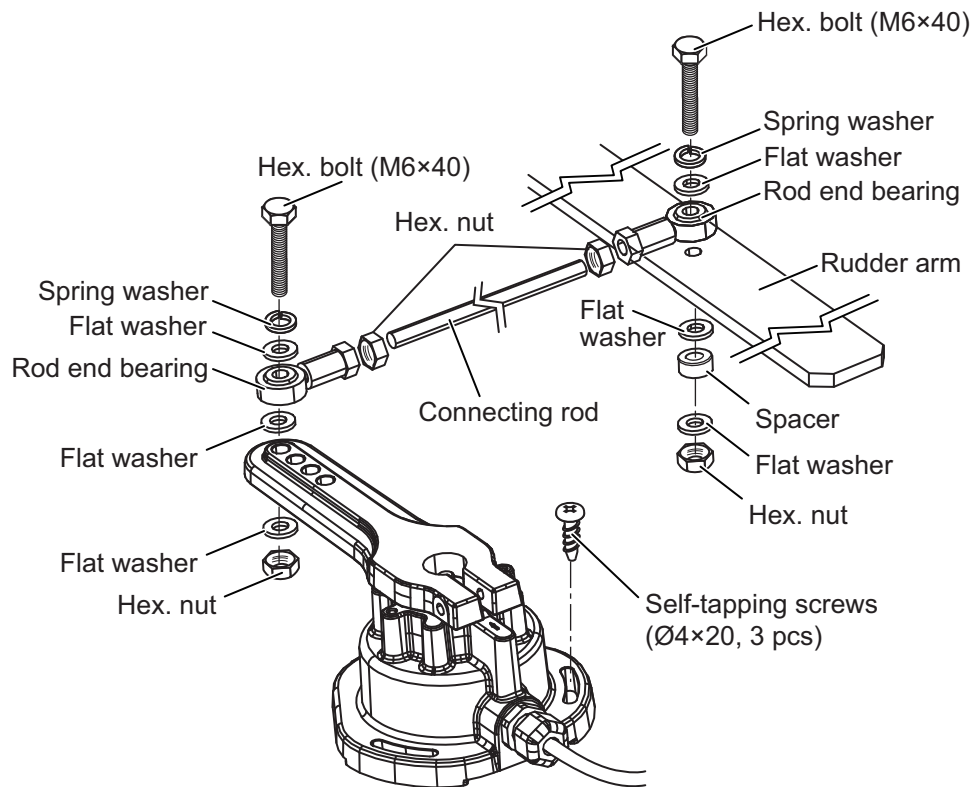

1.3.2 Adjustment after mounting

After mounting the RRU, adjust it as follows:

1. Center the rudder.
2. With the rudder centered, check if the notch is aligned with the arrow mark. If it is, no further adjustment is necessary. If not, go to step 3.

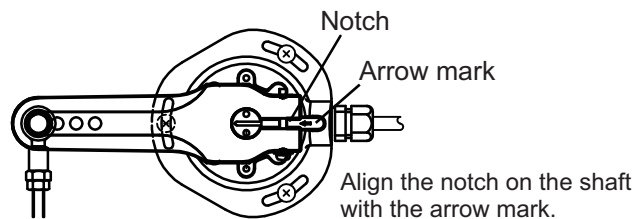

3. Loosen the screw on the arm of the RRU then align notch with the arrow mark.
4. Tighten the screw.

1.3.3 How to select a reversible pump

The Accu-Seer HRP series reversible pump is recommended. When you use the HRP series reversible pump, calculate the optimum pump discharge amount from the following parameters, to select an appropriate reversible pump.

1. MOUNTING

- **Cylinder capacity (cc or cu inch):** Contact the manufacturer of the cylinder.
- **Maximum cylinder operating angle (°):** Contact the manufacturer of the cylinder.
- **Rudder speed (°/s):** 5 to 7 °/s is appropriate.

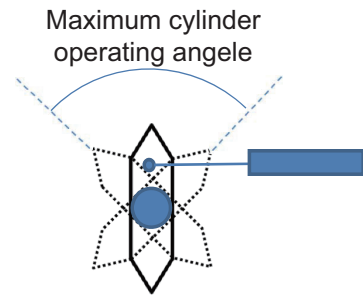

Calculating formula for the optimum pump discharge amount is shown below. Select appropriate formula depending on the cylinder capacity unit ("cc" or "cu inch").

Note: Use the following formula regardless of the number of engines.

Cylinder capacity unit is "cc":

$$\text{Optimum pump discharge amount (cu inch/sec)} = \frac{\text{Cylinder capacity (cc)} \times \text{Rudder speed (°/sec)}}{\text{Maximum cylinder operating angle (°)} \times 16.387064}$$

Cylinder capacity unit is "cu inch":

$$\text{Optimum pump discharge amount (cu inch/sec)} = \frac{\text{Cylinder capacity (cu inch)} \times \text{Rudder speed (°/sec)}}{\text{Maximum cylinder operating angle (°)}}$$

Select an appropriate reversible pump, referring to the following table. For example, when calculated optimum discharge amount is "0.6 cu inch/sec" and ship's length is "28 ft", "HRP-11" is appropriate.

Accu-Steer Reversible Pump	Optimum pump discharge amount	Ship's length
HRP-05	0.25 to 0.5 cu inch/sec	20 ft
HRP-11	0.5 to 1 cu inch/sec	25 to 35 ft
HRP-17	0.8 to 1.6 cu inch/sec	30 to 50 ft
HRP-100	3.2 to 6.4 cu inch/sec	50 ft or more

1.3.4 Reversible pump flow rate and steering cylinder capacity

The following table shows a rough guideline to determine the proper reversible pump flow rate to match with the hydraulic steering cylinder capacity. Your experience with specific boat designs may cause you to select a pump/cylinder relationship outside of the range of these guidelines.

Pump spec.	Hardover to Hardover is 70°	Hardover to Hardover is 90°
1.0 cu inch/sec pump	5.85 to 17.5 cu inch	7.5 to 22.5 cu inch
1.6 cu inch/sec pump	9.36 to 28.0 cu inch	12.0 to 36.0 cu inch

If the hydraulic cylinder capacity is much smaller than the recommended values in the table, the rudder turning speed may be too fast for the pilot to deliver proper performance. The rudder deadband will decrease and the NAVpilot may not apply enough voltage for the pump motor to start because the applied "duty cycle" will be too low.

If the hydraulic cylinder capacity is much larger than the recommended values in the table, the rudder turning speed may be too slow to allow the NAVpilot to control the boat effectively.

Notices for the reversible pump

- When a reversible pump is installed newly, it is required to branch the hydraulic line between the helm pump and cylinder to connect the reversible pump. Therefore, prepare the installation materials to branch the hydraulic line (piping joint, hydraulic pressure hose, sealing tape, etc). If the pipe diameter of the reversible pump is different from the existing pipe, a pitch conversion fitting is also necessary.
- The hydraulic line for the reversible pump must be as short and thick as possible.
- Install the reversible pump horizontal to the ground.
- Perform air bleeding (see section 3.4) after installing the reversible pump.

1.3.5 What is Fantum Feedback™?

Fantum Feedback™ clears the path to a simplified installation, while also delivering enhanced steering control. With Fantum Feedback™, NAVpilot outboard installations no longer require use of a physical rudder reference unit.

Fantum Feedback™ achieves precise course control, from slow trolling speeds to high-speed cruising, utilizing a newly developed gain process, rather than traditional rudder angle based control.

To use Fantum Feedback™, keep the following in mind.

- The ship motor is outboard or in/outboard.
- The length of the ship is 40 ft or less.
- [Drive Unit], in the [Dockside Setup] menu should be set to [Reversible 24V(or 12V)] (see section 3.4).
- The rudder angle indicator is unavailable. The steering direction indicator appears instead of the rudder angle indicator.
- Center the rudder before activating the SABIKI™ mode. If the SABIKI™ mode is activated when the rudder is turned, the autopilot cannot control the vessel properly.

1. MOUNTING

This page is intentionally left blank.

2. WIRING

The following illustration shows the general connection of the NAVpilot-300. For detailed information, see the interconnection diagram at the back of this manual.

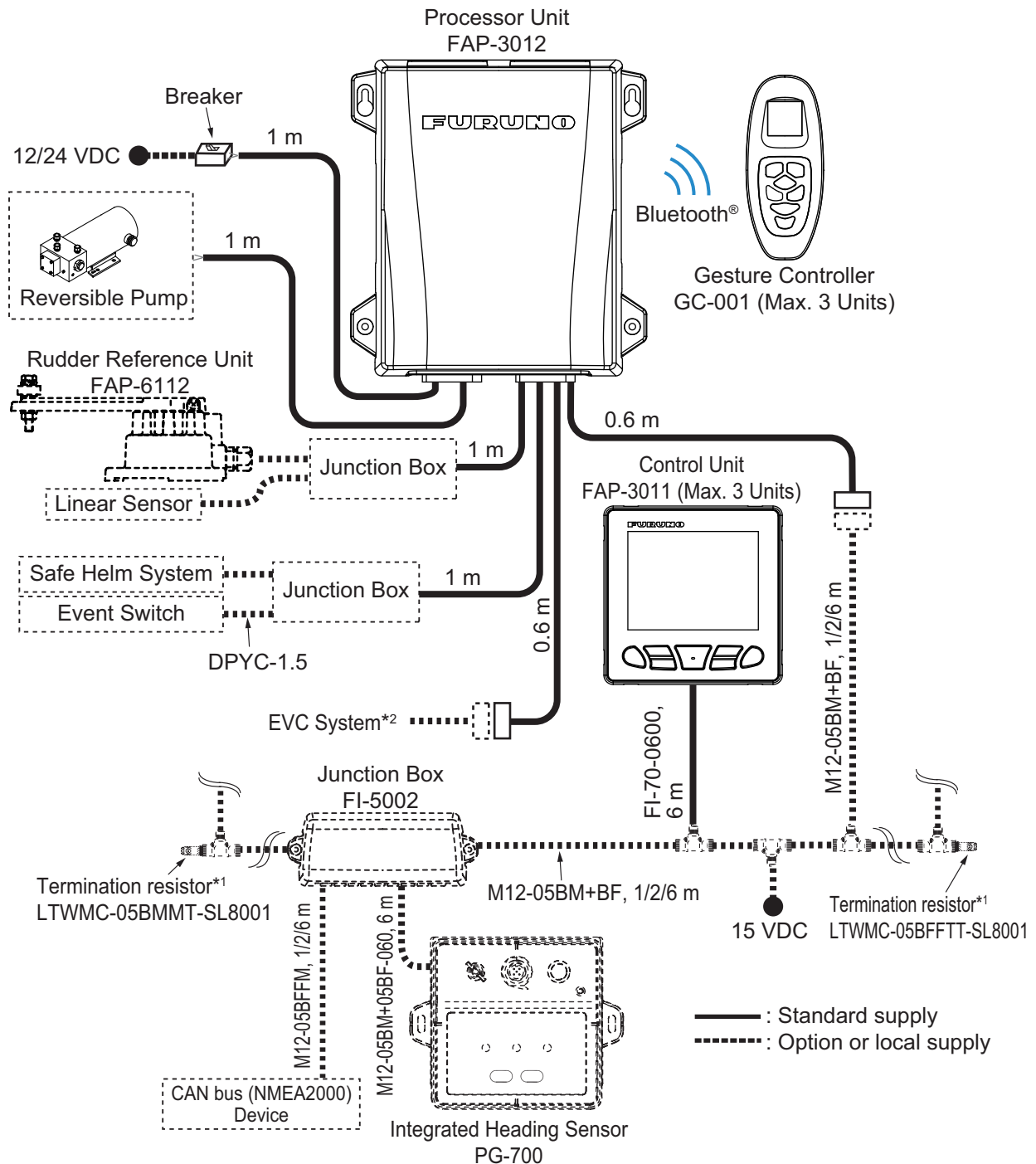

*1: Termination resistors must be installed at both ends of the backbone.

*2: EVC systems compatible with the NAVpilot are as follows:

EVC System	Remarks
VOLVO PENTA IPS	Requires VOLVO IPS gateway (available as an optional extra).
YAMAHA Helm Master	Requires YAMAHA HM gateway (available as an optional extra).
YANMAR VC10	-
DOMETIC OPTIMUS	The software version of the Main PCM (Pump Control Module) must be "Rev. T" or later.

How to secure and waterproof the cable connections

The connector at the rear of the control unit and all cable connections should be waterproofed and secured after making the connection.

To waterproof and secure each connection, refer to the following procedure.

- Securing and waterproofing the connector at the rear of the control unit

- 1) Wrap the connector with the vinyl tape.
- 2) Wrap the self-vulcanizing tape over the vinyl tape.

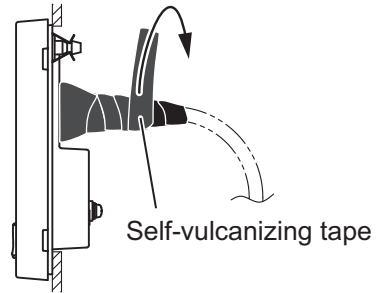
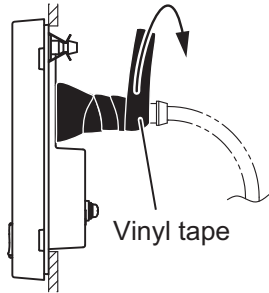

- 3) Wrap the vinyl tape over the self-vulcanizing tape.

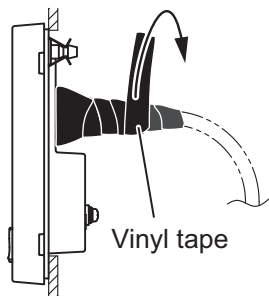

- 4) Apply a marine sealant around the base of the connector.

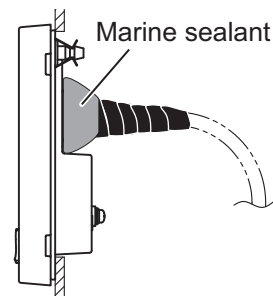

- Securing and waterproofing connections

- 1) Wrap the connector with the vinyl tape.
- 2) Wrap the self-vulcanizing tape over the vinyl tape.

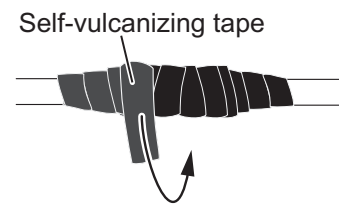
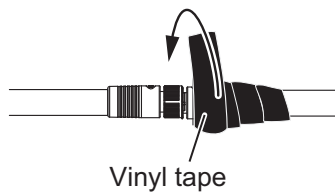

- 3) Wrap the vinyl tape over the self-vulcanizing tape.

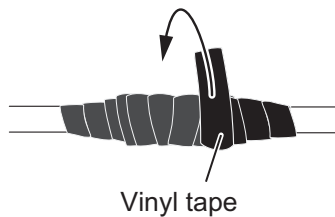

2.1 Processor Unit

Two pigtail cables are attached to the processor unit. All external devices can be connected to processor unit through the pigtail cables. Each cable is labeled with its port name and signals. You can easily find an appropriate port on the pigtail cables.

Note: Although the degree of protection for the processor unit is IP55, the each cable end is not waterproof. Install the processor unit in a waterproof area, or waterproof the cable ends, if these cables are potentially exposed to splash and rain.

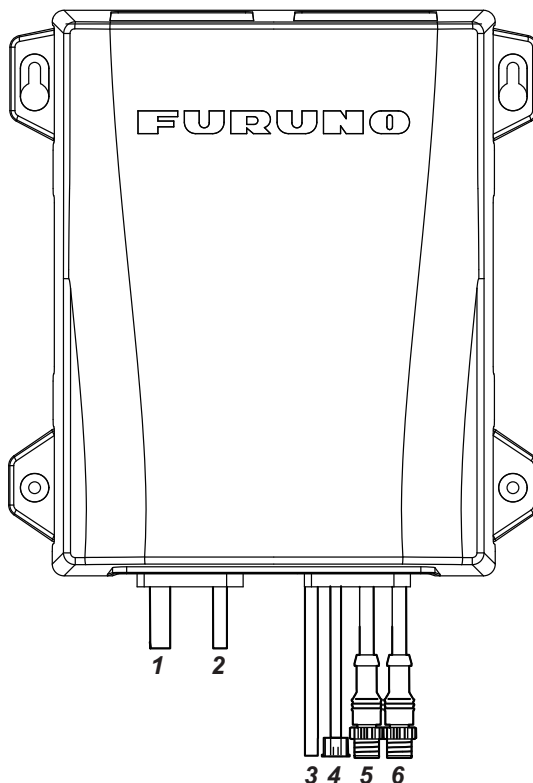

No.	Label	Remarks
1	Power	For power supply (12/24 V DC). Connect the ship's main through a breaker (supplied locally), to turn the power off in case of an emergency. Use a breaker that has a rating acceptable to the motor.
2	Motor	For connecting with motor (reversible pump)
3	RRU	For connecting with the rudder reference unit FAP-6112. A junction box (supplied locally) is required to connect with the RRU.
4	General IN	For connecting with the safe helm block and emergency stop button (event switch). The connector is attached to the General IN cable end, to prevent short circuit. When the General IN cable is used, cut out the connector at the cable end and connect with the safe helm block and event switch through a junction box (supplied locally).
5	DBW	For connecting with the VOLVO IPS gateway, YAMAHA HM gateway, YANMAR VC10 or Dometic Optimus system. Note 1: The connector cover is attached to the DBW cable to waterproof the connector. Do not remove the connector cover when the DBW cable is not used. Note 2: For the Dometic Optimus system, the software version of the Main PCM (Pump Control Module) must be "Rev. T" or later.
6	NMEA2000	For connecting with the CAN bus/NMEA2000 network.

2. WIRING

2.1.1 Power and motor cables

For the power cable and motor line cable, see the following table to select cables.

Rated current of the motor	10 A	
Cable length*	Section of core (mm ²)	AWG
2 m or less	1.00	16
5 m or less	1.25	16
9 m or less	2.00	14
15 m or less	4.00	10

*: Not included the pigtail cable length (1 m).

2.1.2 Emergency stop button

Install the control unit or emergency stop button (supplied locally) near each helm station, to disable rudder control by the autopilot in an emergency.

When you install an emergency stop button, connect the event switch (supplied locally) to the General IN of the processor unit through a junction box (supplied locally).

When the emergency button is pressed, autopilot rudder control is disabled and steering mode changes to the STBY mode (manual steering).

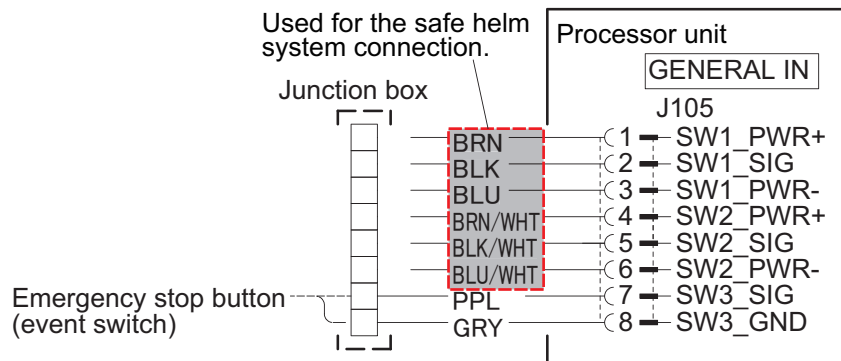

2.1.3 What is CAN bus?

CAN bus is a communication protocol (NMEA2000 compliant) that shares multiple data and signals through a single backbone cable. You can simply connect any CAN bus devices onto the backbone cable to expand your network on-board. With CAN bus, IDs are assigned to all the devices in the network, and the status of each sensor in the network can be detected. All the CAN bus devices can be incorporated into the CAN bus network.

For technical personnel: See “Furuno CAN bus Network Design Guide” (TIE-00170) for details about CAN bus network.

2.1.4 Termination resistors for CAN bus/NMEA2000 network

Termination resistors are required to close off the CAN bus/ NMEA2000 network ends, completing the network.

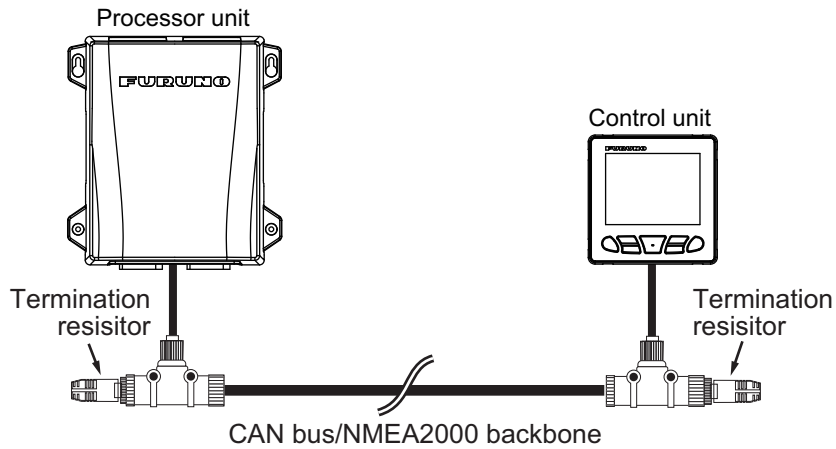

The following optional termination resistors are available:

Name	Type	Code No.	Remarks
Termination Resistor	LTWMN-05AMMT-SL8001	000-160-508-10	Mini connector, male
	LTWMN-05AFFT-SL8001	000-160-509-10	Mini connector, female
	LTWMC-05BMMT-SL8001	000-168-604-10	Micro connector, male
	LTWMC-05BFFT-SL8001	000-168-605-10	Micro connector, female

2.2 Control Unit

The control unit is part of a network, connected via a CAN bus/NMEA2000 backbone. Power is also supplied via the CAN bus/NMEA2000 backbone to the control unit. A maximum of three control units can be connected in the same network.

Note: Unlike the NAVpilot-700 series, the NAVpilot-300 control unit can not be daisy-chained. When retrofitting from the NAVpilot-700 series, connect each control unit to the CAN bus (NMEA2000) backbone.

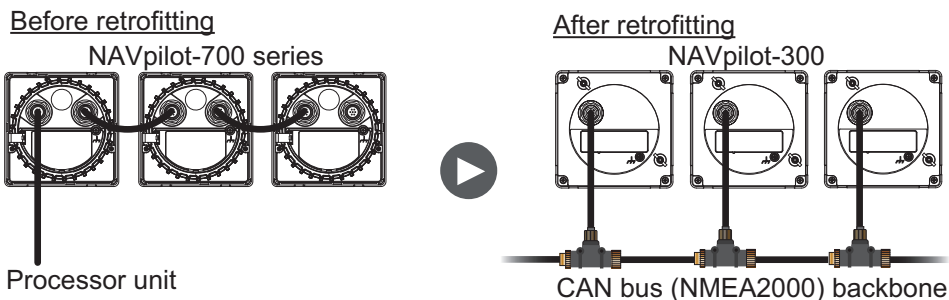

Connection

Using the supplied cable assembly, connect the control unit to the CAN bus/ NMEA2000 network backbone. The control unit must be on the same network as the processor unit.

2. WIRING

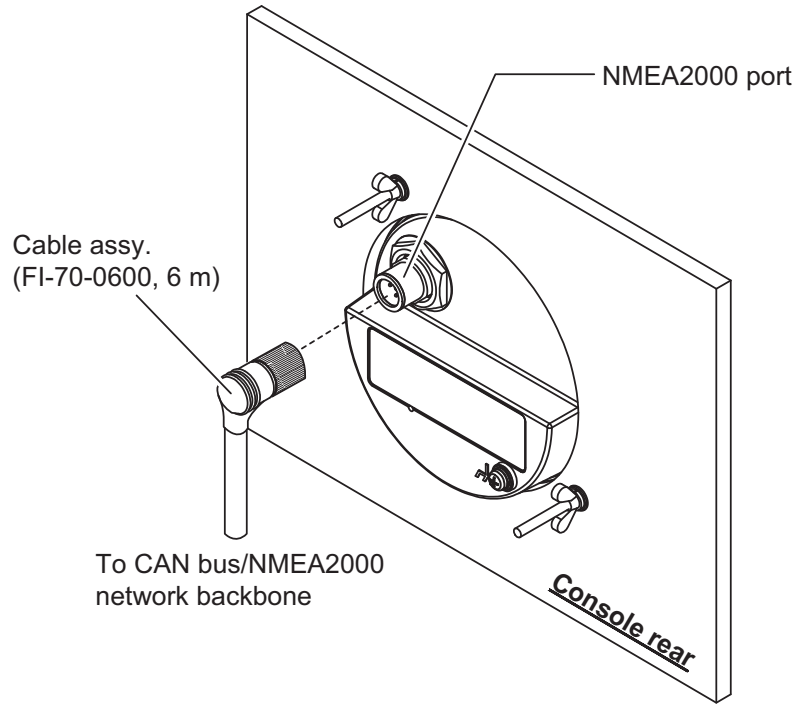

2.3 Junction Box (Option)

The optional junction box FI-5002 has two backbone ports and allows up to six CAN bus/NMEA2000 devices to be networked together. The FI-5002 can be available for connecting between the processor unit and control unit.

When using the FI-5002 to connect between processor unit and control unit, fabricate the drop cable, then connect the cable to the FI-5002 internal MC connectors (CN3 to CN5).

For details about the FI-5002 installation, refer to the installation instructions (C72-00702) supplied with the FI-5002.

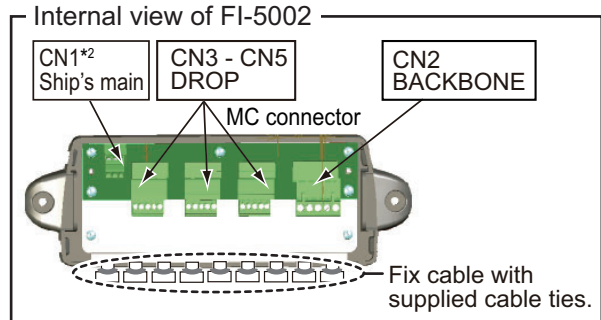
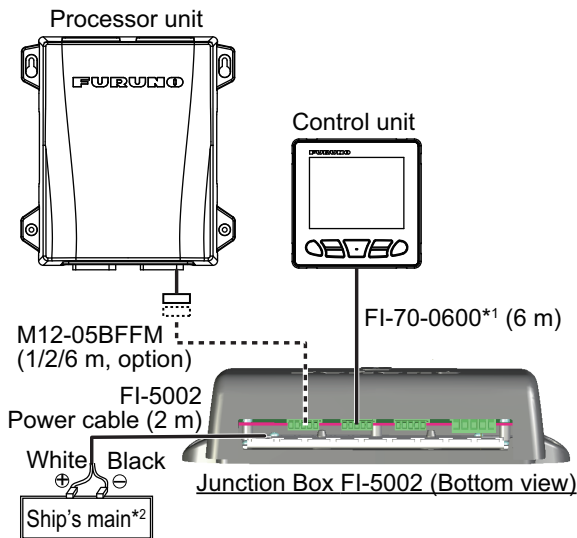

*1: The FI-70-0600 cable, which is supplied with the control unit, has the connectors at both cable ends. Cut off the connector at the junction box end to connect the MC connectors.

*2: When the FI-5002 is added to the existing CAN bus network, power supply to the CN1 is not required. Power is supplied via the CAN bus backbone (CN2).

2.3.1 Additional installation to the existing CAN bus network

When the FI-5002 is added to the existing CAN bus network, it is not required to connect the power to the FI-5002 (CN1). Power is supplied via the CAN bus backbone to the FI-5002 (CN2).

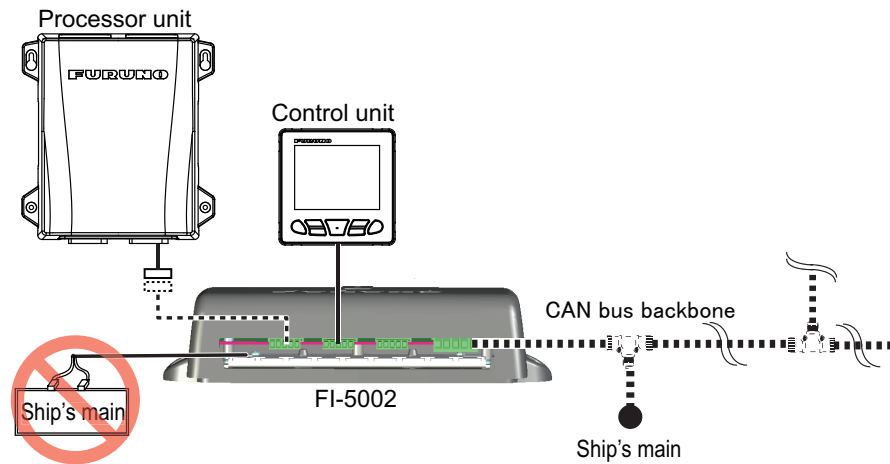

2.3.2 How to fabricate the drop cable

Fabricate the drop cable as shown in the following figure to connect the MC connector. When you use the drop cable which has connectors at both cable ends, it is required to cut out either one of the connector to connect the MC connector.

Pin No.	Signal	Wire
1	SHIELD	Drain
2	NET-S	Red
3	NET-C	Black
4	NET-H	White
5	NET-L	Blue

How to insert cores:

1. Twist the cores.
2. Unfasten the screw with Philips head screwdriver.
3. Set the core to hole.
4. Tighten the screw.
5. Pull the wire to confirm connection.

2.3.3 Termination resistor in the FI-5002

The FI-5002 has two termination resistors (R1 and R2). The resistors are set in the following manner:

- When no backbone cable is connected, R1 and R2 are set to ON position.
- When one backbone cable is connected, either R1 or R2 is set to ON position.
- When two backbone cables are connected, R1 and R2 are set to OFF position.

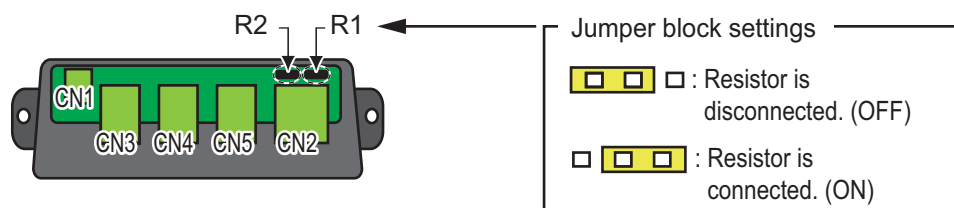

2.4 Input/Output PGNs

2.4.1 Input/output PGNs for processor unit

The processor unit can input/output following PGNs:

Input PGNs for processor unit

PGN	Description
059392	ISO Acknowledgement
059904	ISO Request
060160	ISO Transport Protocol, Data Transfer
060416	ISO Transport Protocol, Connection Management - BAM group function
060928	ISO Address Claim
061184	FURUNO Proprietary PGN
065240	ISO Commanded Address
126208	NMEA - Request group function
	NMEA - Command group function
	NMEA - Acknowledge group function
126464	PGN List - Transmit PGN's group function
126720	FURUNO Proprietary PGN
126992	System Time
126996	Product Information
127250	Vessel Heading
127258	Magnetic Variation
128259	Speed, Water referenced
129025	Position, Rapid Update
129026	COG & SOG, Rapid Update
129029	GNSS Position Data
129033	Local Time Offset
129283	Cross Track Error
129284	Navigation Data
129285	Navigation - Route/WP Information
130577	Direction Data
130818	FURUNO Proprietary PGN
130821	FURUNO Proprietary PGN
130823	FURUNO Proprietary PGN
130827	FURUNO Proprietary PGN
130841	FURUNO Proprietary PGN

Output PGNs for processor unit

PGN	Description	Sending Cycle
059392	ISO Acknowledgement	Non-periodic
059904	ISO Request	Non-periodic
060928	ISO Address Claim	Non-periodic
126208	NMEA - Request group function	Non-periodic
	NMEA - Command group function	Non-periodic
	NMEA - Acknowledge group function	Non-periodic
126464	PGN List - Transmit PGN's group function	Non-periodic
	PGN List - Received PGN's group function	Non-periodic

PGN	Description	Sending Cycle
126720	FURUNO Proprietary PGN	Non-periodic
126993	Heartbeat	60,000 ms
126996	Product Information	Non-periodic
126998	Configuration Information	Non-periodic
127237	Heading/Track Control	250 ms
127245	Rudder	100 ms
130816	FURUNO Proprietary PGN	Non-periodic
130821	FURUNO Proprietary PGN	Non-periodic
130822	FURUNO Proprietary PGN	Non-periodic
130823	FURUNO Proprietary PGN	Non-periodic
130825	FURUNO Proprietary PGN	Non-periodic
130827	FURUNO Proprietary PGN	Non-periodic
130841	FURUNO Proprietary PGN	Non-periodic

2.4.2 Input/output PGNs for control unit

The control unit can input/output following PGNs:

Input PGNs for control unit

PGN	Description
059392	ISO Acknowledgement
059904	ISO Request
060160	ISO Transport Protocol, Data Transfer
060416	ISO Transport Protocol, Connection Management - BAM group function
060928	ISO Address Claim
065240	ISO Commanded Address
126208	NMEA - Request group function
	NMEA - Command group function
	NMEA - Acknowledge group function
126464	PGN List - Transmit PGN's group function
126720	FURUNO Proprietary PGN
126992	System Time
126996	Product Information
127245	Rudder
127250	Vessel Heading
127258	Magnetic Variation
128259	Speed, Water referenced
129025	Position, Rapid Update
129026	COG & SOG, Rapid Update
129029	GNSS Position Data
129033	Local Time Offset
129283	Cross Track Error
129284	Navigation Data
129285	Navigation - Route/WP Information
130577	Direction Data
130816	FURUNO Proprietary PGN
130818	FURUNO Proprietary PGN
130821	FURUNO Proprietary PGN
130823	FURUNO Proprietary PGN

2. WIRING

PGN	Description
130825	FURUNO Proprietary PGN
130827	FURUNO Proprietary PGN
130841	FURUNO Proprietary PGN

Output PGNs for control unit

PGN	Description	Sending Cycle
059392	ISO Acknowledgement	Non-periodic
059904	ISO Request	Non-periodic
060928	ISO Address Claim	Non-periodic
061184	FURUNO Proprietary PGN	Non-periodic
126208	NMEA - Request group function	Non-periodic
	NMEA - Command group function	Non-periodic
	NMEA - Acknowledge group function	Non-periodic
126464	PGN List - Transmit PGN's group function	Non-periodic
	PGN List - Received PGN's group function	Non-periodic
126720	FURUNO Proprietary PGN	Non-periodic
126993	Heartbeat	6,000 ms
126996	Product Information	Non-periodic
126998	Configuration Information	Non-periodic
130825	FURUNO Proprietary PGN	Non-periodic
130827	FURUNO Proprietary PGN	Non-periodic
130841	FURUNO Proprietary PGN	Non-periodic

3. INITIAL SETTING

This chapter shows you how to enter initial settings. The menu contains some items that may not apply to your system. Minimally, the settings on the following menus must be done:

- [Ship's Characteristics] menu
- [Dockside Setup] menu

Note: The [Dockside Setup] menu is not shown for EVC system equipped boat.

3.1 [Initialization] Menu



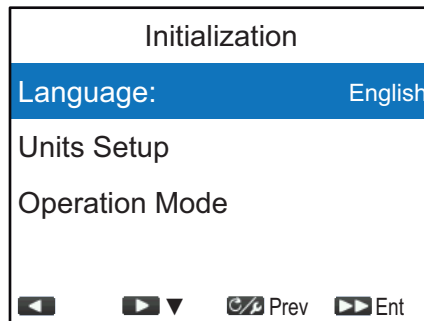

After mounting and wiring are completed, press the  key to turn the system on. The first time the system is powered, the [Initialization] menu appears.

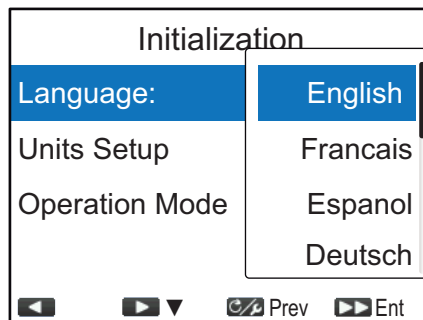

Follow the procedure below to set up the NAVpilot-300.

1. [Language] is selected, press the  key.



2. Press the  key to select the appropriate language, then press the  key to apply the setting.
3. Press the  key to select [Units Setup], then press the  key.

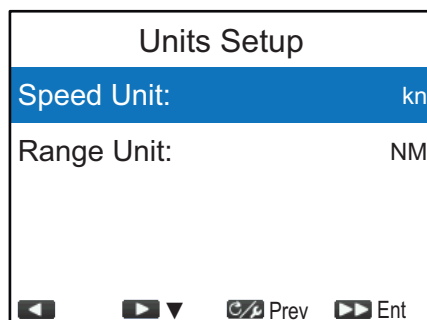





3. INITIAL SETTING

- Select the appropriate unit to adjust, then press the  key.

The following table shows available options for each unit.

Unit	Available options
Speed	[kn] (knot), [km/h] (kilometers per hour), [MPH] (miles per hour)
Range	[NM] (nautical miles), [km] (kilometers), [SM] (statute miles), [NM, yd] (nautical miles, yards), [NM, m] (nautical miles, meters), [km, m] (kilometers, meters), [SM, yd] (statute miles, yards)

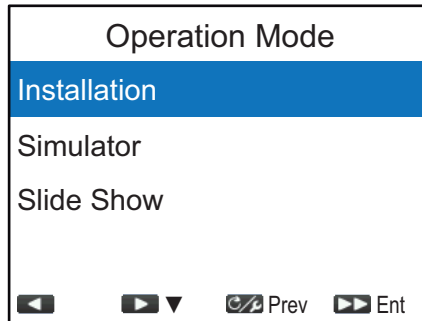

- Select the units as required, then press the  key.
- Press the  key to go back to the [Initialization] menu.
- Press the  key to select [Operation Mode], then press the  key.

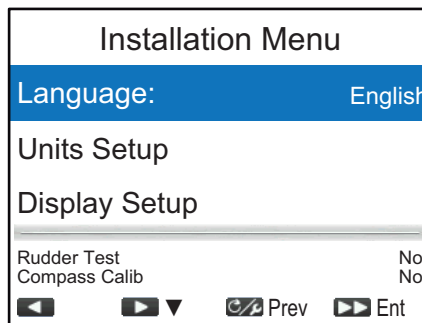

- [Installation] is selected, press the  key to open [Installation Menu].



Note 1: [Simulator] and [Slide Show] are not used for normal operation.

Note 2: [Installation Menu] can be opened from the STBY mode, by pressing the  key three times while holding down the  key.

- Follow the procedures in the remaining sections (in the order shown) of this chapter to set up the NAVpilot.

Note: [Installation Menu] can be accessed and adjusted from the TZTL12F/TZTL15F/TZT2BB. Keep in mind the following points when you access the [Installation Menu] from the TZTL12F/TZTL15F/TZT2BB:

- Do not operate the NAVpilot-300 from multiple TZTL12F/TZTL15F/TZT2BB simultaneously. Simultaneous operation from multiple TZTL12F/TZTL15F/TZT2BBs can result in incorrect settings and/or malfunction.
- The software version of the TZTL12F/TZTL15F/TZT2BB must be version "06.01" or later.

For how to operate the NAVpilot-300 from the TZTL12F/TZTL15F/TZT2BB, see the operator's manual of the TZTL12F/TZTL15F/TZT2BB.

3.2 [Display Setup] Menu

The [Display Setup] menu sets up the display indications according to your needs, like how to show the date and time. To open the [Display Setup] menu, select [Display Setup] from the [Installation Menu].

Display Setup	
Position Format:	DD°MM.MMM'
Heading Display:	Magnetic
Compass Display:	Heading Up
Time Offset:	0:00

Menu item	Description
[Position Format]	Select how to show the position indication, in degrees, minutes, seconds. Setting range: [DD°MM.MM'], [DD°MM.MMM], [DD°MM.MMMM'], [DD°MM'SS.S]
[Heading Display]	Select how to show heading, true or magnetic. <ul style="list-style-type: none"> [Magnetic]: Use the magnetic heading. [True]: Use the true heading.
[Compass Display]	Select the orientation mode for the compass display. <ul style="list-style-type: none"> [Heading Up]: The compass rotates to keep the ship's heading (gray pointer) at the top of the display. [Course Up]: The compass rotates to keep the set course (red pointer) at the top of the display.
[Time Offset]	Enter the time difference between local time and UTC time. Setting range: -14:00 to +14:00

3.3 [Ship's Characteristics] Menu

The [Ship's Characteristics] menu sets up the NAVpilot according to the boat type, etc. To open the [Ship's Characteristics] menu, select [Ship's Characteristics] from the [Installation Menu].

Ship's Characteristics	
Boat Type:	Outboard
Rudder Sensor*:	Fantum Feedback
Cruising Speed:	30kn
Rate of Turn:	5°/s

*: [Rudder Sensor] is changed to [EVCS Pwr Supply] when [Boat Type] is set to [EVCS-Pod Drive], [EVCS-Outboard], [EVCS-In/Out] or [EVCS-Inboard].

3. INITIAL SETTING

Menu item	Description
[Boat Type]	Select your boat type. <ul style="list-style-type: none"> • [Outboard]: Outboard motor boat • [In/Outboard]: Inboard/outboard motor boat • [Inboard]: Inboard motor boat • [EVCS-Pod Drive]: EVC (Electronic Vessel Control) pod drive equipped boat • [EVCS-Outboard]: Outboard EVC system equipped boat • [EVCS-In/Out]: Inboard/outboard motor EVC system equipped boat • [EVCS-Inboard]: Inboard EVC system equipped boat
[Rudder Sensor]	Select your rudder sensor (rudder reference unit) type. <ul style="list-style-type: none"> • [Fantom Feedback]: Rudder sensor is not installed. For details of Fantom Feedback™, see section 1.3.5. • [Rotary (Inboard)]: For FURUNO rudder reference unit FAP-6112. • [Linear (outboard)]: For DOMETIC linear sensor AR4502. <p>Note: [Rudder Sensor] is shown when [Boat Type] is set to [Outboard], [In/Outboard] or [Inboard].</p>
[EVCS Pwr Supply]	Select whether the power is supplied or not from the EVC system, according to the specifications of the EVC system connected to the NAVpilot (DBW port). <ul style="list-style-type: none"> • [Input]: The power is supplied from the EVC system to the NAVpilot (DBW port). Select this option when the NAVpilot is connected with the Dometic Optimus or YANMAR VC10 system. • [Output]: The power is supplied from the NAVpilot (DBW port) to the EVC system. Select this option when the NAVpilot is connected with the VOLVO PENTA IPS or YAMAHA Helm Master system. <p>Note: [EVCS Pwr Supply] is shown when [Boat Type] is set to [EVCS-Pod Drive], [EVCS-Outboard], [EVCS-In/Out] or [EVCS-Inboard].</p>
[FishHunterDrive]	Selects the FishHunter™ Drive On/Off. <p>Note: [FishHunterDrive] is not shown when [Boat Type] is set to [Outboard] or [EVCS-Outboard].</p>
[Boat Length]	Enter the length of your boat. <p>Note: [EVCS Pwr Supply] is shown when [FishHunterDrive] is set to [On].</p>
[Cruising Speed]	Enter the cruising speed of your boat.
[Rate of Turn]	Enter the rate of turn of your boat. <p>Note: Enter the [Rate of Turn] according to your boat's specifications. If the rate is set higher than your boat's specifications, the rudder may turn abruptly when arriving at a waypoint, creating a dangerous situation. Further, it may not be possible to change course correctly if the rate is higher than the actual rate of turn of your boat.</p>

3.4 [Dockside Setup] Menu

The [Dockside Setup] menu for the rudder reference unit (rudder sensor) and Fantum Feedback™ is different. To open the [Dockside Setup] menu, select [Dockside Setup] from the [Installation Menu].

Note: The [Dockside Setup] menu is not shown when [Boat Type] is set to [EVCS-Pod Drive], [EVCS-Outboard], [EVCS-In/Out] or [EVCS-Inboard].

3.4.1 [Dockside Setup] menu for the rudder reference unit

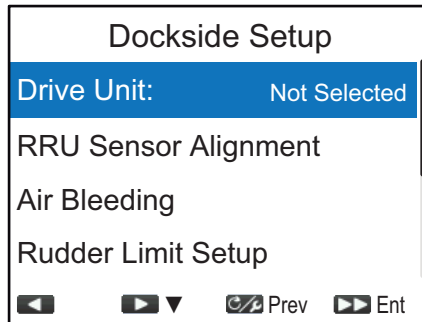

[Drive Unit]

- [Drive Unit] is selected on the [Dockside Setup] menu, press the key.
- Press the key to select the drive unit, then press the key.
 - [Reversible 24V]: Reversible pump 24V
 - [Reversible 12V]: Reversible pump 12V
 - [Safe Helm 24V]: Accu-Steer FPS 24V drive unit
 - [Safe Helm 12V]: Accu-Steer FPS 12V drive unit

Reversible 24V

Reversible 12V

Safe Helm 24V

Safe Helm 12V

[RRU Sensor Alignment]

- Press the key to select [RRU Sensor Alignment] from the [Dockside Setup] menu, then press the key.
The message shown to the right appears.

Measure rudder center position and confirm displayed value is $< 5^\circ$
If not, adjust RRU arm or magnet. NAVpilot will correct reversed PORT & STBD indication later.
Press any key to continue

3. INITIAL SETTING

2. Press any key to close the message and start the RRU sensor alignment.

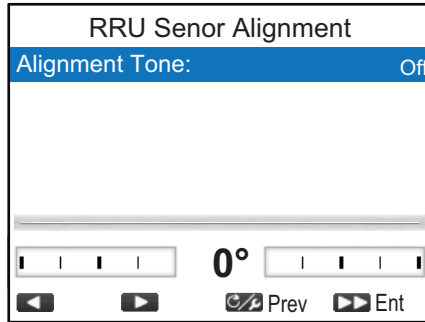



3. With the rudder physically centered, confirm that the displayed rudder angle indication is less than or equal to $\pm 5^\circ$. If not, you must adjust the rudder sensor body or magnet position (For DOMETIC linear sensor AR4502) so that the indicator is within $\pm 5^\circ$ before continuing.





Note: If the rudder angle indication shows “*9°”, input data exceed the display range or the processor unit does not detect the rudder reference unit. Check the connection with the rudder reference unit.

- [Alignment Tone]: There is an alignment tone that you can use to help you make this adjustment remotely. A beep sounds continuously when the indicator is within $\pm 5^\circ$. If you do not need the alignment tone, set [Alignment Tone] to [Off].
4. Press the  key to close the [RRU Sensor Alignment] window and go back to the [Dockside Setup] menu.

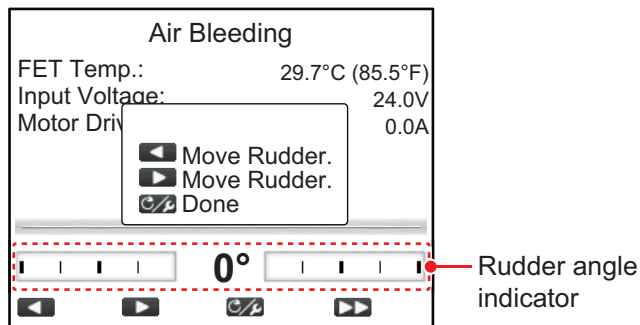
[Air Bleeding]



1. Press the  key to select [Air Bleeding] from the [Dockside Setup] menu, then press the  key.





2. Press the  key until the rudder angle indicator is completely filled.
3. Remove the appropriate rudder cap of the cylinder to bleed air, then reattach the cap.
4. Press the  key until the rudder angle indicator is completely filled.
5. Remove the appropriate rudder cap of the cylinder to bleed air, then reattach the cap.
6. Repeat step 2 to step 5 to bleed air completely.
7. Press the  key to finish the air bleeding.
8. Press the  key to close the [Air Bleeding] window and go back to the [Dockside Setup] menu.

[Rudder Limit Setup]



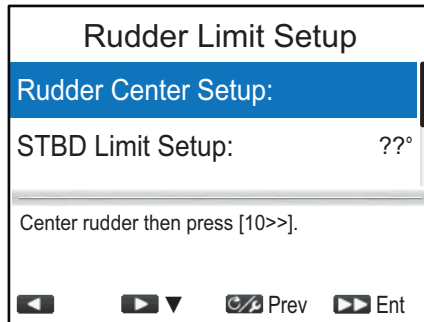





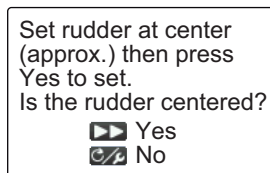



Set the rudder center position, then set the maximum rudder limits, or "hard over" points, for the rudder system. It does not matter which way the rudder reference unit arm or linear sensor rod is installed as this correction will be done electronically. Therefore, it is recommended that you make both port and starboard rudder values the same.

1. Press the  key to select [Rudder Limit Setup] from the [Dockside Setup] menu, then press the  key.



2. [Rudder Center Setup] is selected, press the  key. The following message appears.



3. Turn the helm so that the rudder is centered, then press the  key.
4. Press the  key to select [STBD Limit Setup], then press the  key.
5. Turn the helm hard-over to starboard, then measure the rudder angle.
6. Press the  or  key to enter the starboard rudder limit, then press the  key.
7. Press the  key to select [PORT Limit Setup], then press the  key.
8. Turn the helm hard-over to port, then measure the rudder angle.
9. Press the  or  key to enter the port rudder limit, then press the  key.
10. Press the  key to close the [Rudder Limit Setup] menu and go back to the [Dockside Setup] menu.

Note 1: If one of the following messages appears, retry the rudder limit setup. If the message appears again, adjust the rudder reference unit.

- RRU center is misaligned. Turn helm or adjust RRU, then try again.
- RRU STBD (or PORT) pos is out of range-turn helm or adjust RRU then try again.
- RRU Setup Error-Must turn helm hard over PORT/STBD. Retry?

Note 2: When you try to escape from the [Rudder Limit Setup] menu and there is some uncompleted setting items, the message shown below appears. Confirm the items shown on the message, and do the uncompleted items.

3. INITIAL SETTING

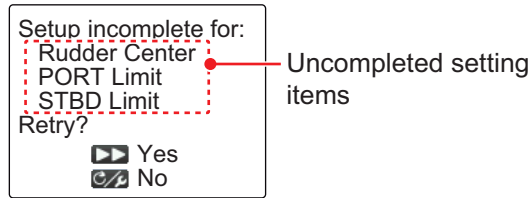

Note 3: After completing the settings on the [Rudder Limit Setup] menu, [Rudder Limit Setup] on the [Dockside Setup] menu changes to [Rudder Limit Setup (Done)].

[Auto Rudder Limit]

Auto rudder limit determines the maximum rudder movement in degrees from the mid position in the AUTO, NAV, Turn, FishHunter™ and Dodge modes.

Note: Complete the setting items on the [Rudder Limit Setup] menu before entering the auto rudder limit.

1. Press the **▶** key to select [Auto Rudder Limit] from the [Dockside Setup] menu then press the **▶** key.
2. Press the **◀** or **▶** key to adjust the auto rudder limit value, then press the **▶** key.
The value set here should be smaller than the maximum rudder limits set on the [Rudder Limit Setup] menu. It is recommended that [Auto Rudder Limit] is 5° smaller than the maximum rudder limits set on the [Rudder Limit Setup] menu.

[Manual Rudder Limit]

In the dodge mode, usually a wide range of rudder angles are used, and therefore a larger number should be entered. however, the setting must not exceed the rudder limit angle which is inherent on your boat.

Do not set the limit higher than the rudder limit. It is recommended to set the manual rudder limit equal to or greater than the auto rudder limit. If the manual rudder limit is set lower than the auto one, the rudder may be returned to center position too quickly when the vessel is doing automatic turning.

Note: Complete the setting items on the [Rudder Limit Setup] menu before entering the manual rudder limit.



1. Press the **▶** key to select [Manual Rudder Limit] from the [Dockside Setup] menu, then press the **▶** key.
2. Press the **◀** or **▶** key to adjust the manual rudder limit value, then press the **▶** key.

[Rudder Test]

For power steering vessels with an engine-driven power steering pump, the engines must be running and slightly above idle before doing this test.

Note 1: The rudder test cannot be performed if the drive unit has not been selected.

Note 2: BEFORE doing this test, check that [Rudder Deadband] in the [Sea Trial] menu (see section 3.8) is set to [Auto].

1. Press the  key to select [Rudder Test] from the [Dockside Setup] menu, then press the  key.

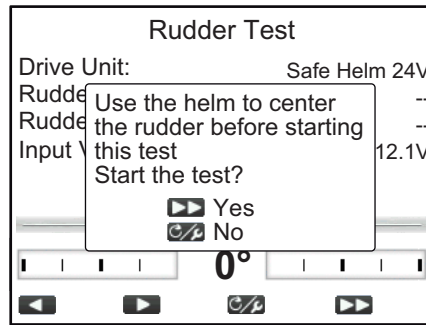

2. Center the rudder then press the  key. During the rudder test, the following message appears.

Testing Rudder-PLS Wait.
Press any key to abort.

After the test is completed, the following message appears.

Rudder Test completed.
Press any key to continue.

Note: When one of the following messages appears, the rudder test could not be completed successfully. Retry the rudder test after resolving the problem.

- Rudder Test failed. Press any key to continue.
- Rudder angle error. Check drive circuit. Press any key to continue.
- Rudder drive error. Check drive circuit. Press any key to continue.

3. Press any key to show the rudder test result.

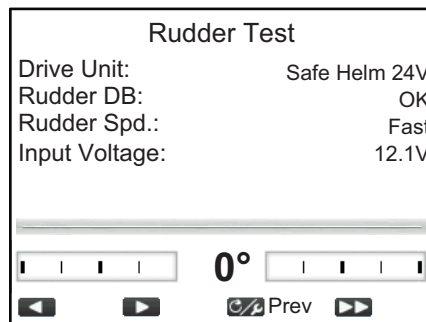

- [Drive Unit]: Drive type used with the NAVpilot: [Reversible 12V (or 24V)] or [Safe-Helm 12V (or 24V)].
- [Rudder Deadband]: Rudder Deadband ([OK] or [Big])
- [Rudder Speed]: Rudder speed ([OK], [Fast], or [Slow])
- [Input Voltage]: Input voltage to the processor unit.

Note 1: If [Rudder Deadband] is [Big], the boat cannot be controlled correctly. Check for air in the steering system and if [Rudder Speed] is [OK].

Note 2: Do not turn the power off within two seconds after finishing the rudder test. If the power is turned off accidentally, retry the rudder test.

4. Press the  key to close the rudder test result.

Note: After completing the rudder test, [Rudder Test] on the [Dockside Setup] menu changes to [Rudder Test (Done)].

3.4.2 [Dockside Setup] menu for Fantum Feedback™

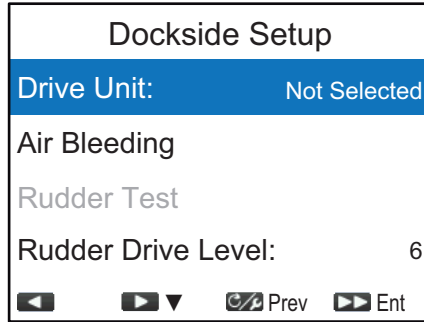

[Drive Unit]

1. [Drive Unit] is selected on the [Dockside Setup] menu, press the key.
2. Press the key to select the drive unit, then press the key.
 - [Reversible 24V]: Reversible pump 24V
 - [Reversible 12V]: Reversible pump 12V
 - [Safe Helm 24V]: Accu-Steer FPS 24V drive unit
 - [Safe Helm 12V]: Accu-Steer FPS 12V drive unit

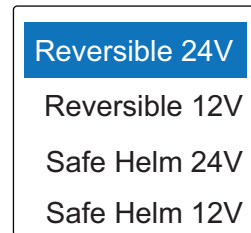

[Air Bleeding]

1. Press the key to select [Air Bleeding] from the [Dockside Setup] menu, then press the key.

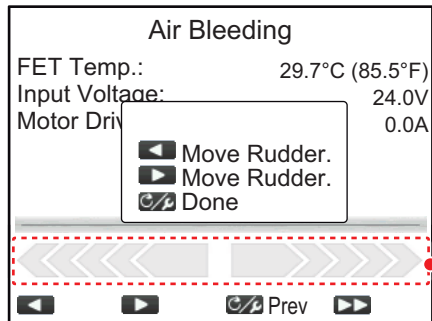



Steering direction indicator

2. Press the key until the steering direction indicator is completely filled.
3. Remove the appropriate rudder cap of the cylinder to bleed air, then reattach the cap.
4. Press the key until the steering direction indicator is completely filled.
5. Remove the appropriate rudder cap of the cylinder to bleed air, then reattach the cap.
6. Repeat step 2 to step 5 to bleed air completely.
7. Press the key to finish the air bleeding.
8. Press the key to close the [Air Bleeding] window and go back to the [Dockside Setup] menu.

[Rudder Test]

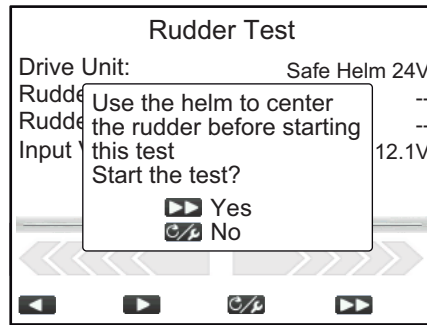

Note: The rudder test cannot be performed if the drive unit has not been selected.

1. Press the  key to select [Rudder Test] from the [Dockside Setup] menu, then press the  key.



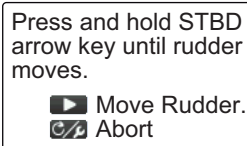

2. Center the rudder then press the  key.

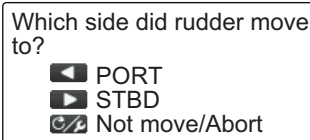

3. Press the  key and confirm the direction of rudder movement.
4. Release the  key.



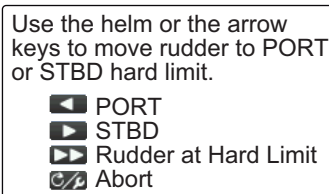

5. Press the  or  key according to the direction of rudder movement found in step 3.



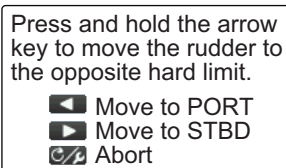

6. Turn the helm or press the  or  key hard-over to PORT or STBD, then press the  key.

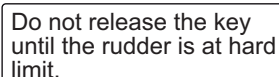

7. Long press the  or  key hard-over in the opposite direction from step 6. While pressing a key, the following message appears.



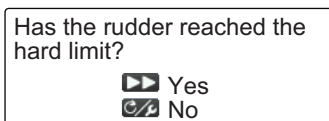

8. When the rudder reaches the hard limit, release the  or  key to display the following message.





3. INITIAL SETTING

9. Do one of the following.

- If the rudder reached the hard limit properly: Press the  key. After pressing the key, the either one of the following messages appears according to the key pressed at step 7.



Press and hold the arrow key to move the rudder to the opposite hard limit.
 Move to PORT
 Abort



Press and hold the arrow key to move the rudder to the opposite hard limit.
 Move to STBD
 Abort



 key is pressed at step 7

 key is pressed at step 7



- If the rudder did not reach the hard limit properly: Press the  key to show the following message.



Rudder Test is incomplete.
Restart?
 Yes
 No

Press the  key to retry the rudder test from step 6. If the  key is pressed, the rudder test is aborted.

10. Long press the  or  key hard-over in the opposite direction from step 7. While pressing a key, the following message appears.

Do not release the key until the rudder is at hard limit.



11. When the rudder reaches the hard limit, release the  or  key to display the following message.



Has the rudder reached the hard limit?
 Yes
 No

12. Do one of the following.



- If the rudder reached the hard limit properly: Press the  key to finish the rudder test. After the rudder test is completed, the following messages appears.



Rudder Test completed.
Press any key to continue.

Note: If the steering speed needs to be adjusted, the following message appears. Press the  key to retry the rudder test from step 6. If the  key is pressed, the rudder test is aborted.

Setting may not be correct, rudder peed is inaccurate.
Restart rudder test?
 Yes
 No

- If the rudder did not reach the hard limit properly: Press the  key to show the following message.

Rudder Test is incomplete.
Restart?
 Yes
 No

Press the  key to retry the rudder test from step 6. If the  key is pressed, the rudder test is aborted.

13. Press any key to show the rudder test result.

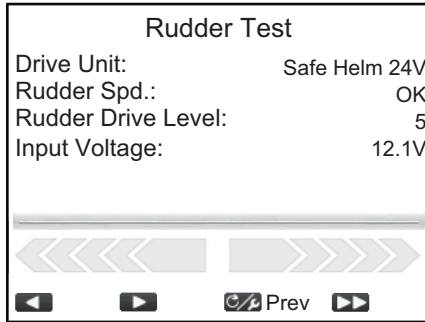

- [Drive Unit:]: Drive type used with the NAVpilot: [Reversible 12V (or 24V)] or [Safe-Helm 12V (or 24V)]
- [Rudder Speed]: Rudder speed ([OK], [Fast], or [Slow])
- [Rudder Drive Level]: The amount of helm operation required to move the rudder.
- [Input Voltage]: Input voltage to the processor unit.

Note: Do not turn the power off within two seconds after finishing the rudder test. If the power is turned off accidentally, retry the rudder test.

14. Press the  key to close the rudder test result.

Note: After completing the rudder test, [Rudder Test] on the [Dockside Setup] menu changes to [Rudder Test (Done)].

3.4.3 [Engine Setup] menu

The [Engine Setup] menu is used to configure settings of the engines. To open the menu, select [Engine Setup] from the [Dockside Setup] menu.

To use the FishHunter™ Drive, enter the maximum ship's speed in this menu.

Note: When you are not sure about the [Max Speed] and [Planing Detection], Refer to "How to set the ship's speed" (see section 3.8.5).

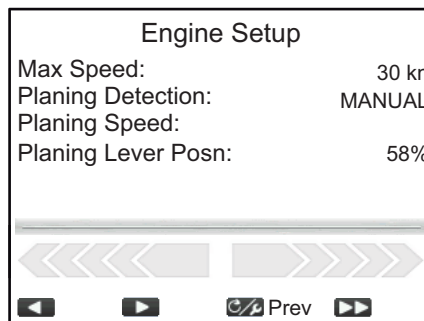

Menu	Function
[Max Speed]	Enter the maximum ship's speed. The rule of thumb is approx. 1.2 times of the ship's cruising speed.
[Planing Detection]	Used to setting of the planing. The following menu appears only when set to [MANUAL]. <ul style="list-style-type: none"> • [Planing Speed]: Set the ship's speed on planing. • [Planing Lever Posn.]: Set the position of lever on planing.



3.4.4 How to set the safe helm mode and power assist mode

The safe helm and power assist features are available with the Accu-Steer FPS 12V (or 24V) drive unit. If your drive unit is different, go to section 3.4.5.

Perform the helm sensor test before safe helm and power assist setup.

Helm sensor test (for Accu-Steer FPS 12V (or 24V) drive)

The helm sensor test checks the connection between the processor unit and the Accu-Steer FPS 12V (or 24V) drive.

1. Press the  key to select [Helm Sensor Test] from the [Dockside Setup] menu, then press the  key.

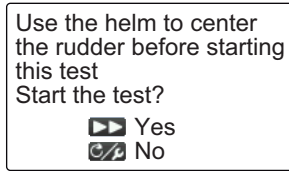

2. Center the rudder then press the  key.
One of the following messages appears.



When the RRU is installed

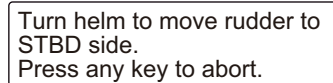

For Fantum Feedback™

3. **When the RRU is installed:** Turn the helm to PORT or STBD direction.
For Fantum Feedback™: Turn the helm to STBD direction.

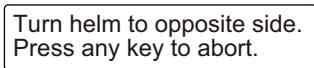

When the RRU is installed

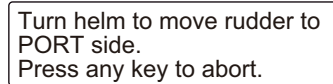

For Fantum Feedback™

4. **When the RRU is installed:** Turn the helm to the opposite direction from step 3.
For Fantum Feedback™: Turn the helm to PORT direction.

If the connection is normal, the message "Helm Sensor Test completed. Press any key to continue." appears. For failure, "Helm Sensor Test failed. Check the sensor. Press any key to continue." appears. Check that your helm sensor is Accu-Drive FPS 12V/24V. Also, check that the helm sensor is correctly connected to the processor unit.

5. Press any key to show the helm sensor test result.

Following display example is for the Fantum Feedback™. When the RRU is installed, the appearance of the indicator at the bottom of the screen changes.

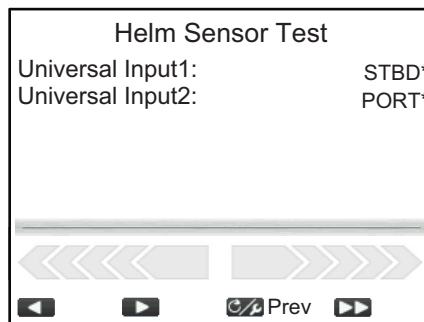

*: "--" appears if the test failed.

6. Press the  key to close the test result.

Note: After completing the helm sensor test, [Helm Sensor Test] on the [Dockside Set-up] menu changes to [Helm Sensor Test (Done)].

Safe helm setup (for Accu-Steer FPS 12V (or 24V) drive)

Set up the safe helm function from the [Safe Helm Setup] menu. To open the [Safe Helm Setup] menu, select [Safe Helm Setup] from the [Dockside Setup] menu.

Note: The safe helm setup cannot be performed if the safe helm test is not complete.

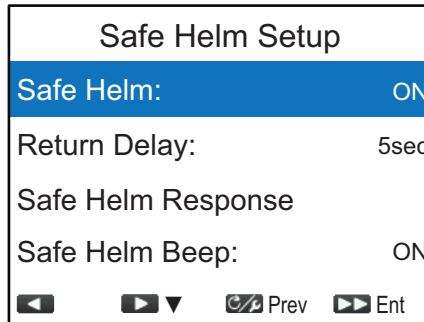

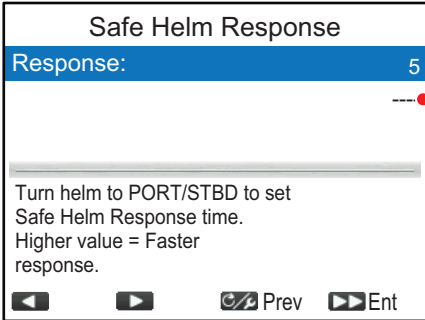
Menu item	Description
[Safe Helm]	Turn the safe helm mode on or off. The safe helm mode, available with the Accu-Steer FPS 12V/24V drive unit, temporarily switches the NAVpilot to manual steering for the specified time interval when the helm is steered in an automatic steering mode. This prevents continued turning of the helm. The mode and course indications flash when the safe helm mode activates.
[Return Delay]	Set the time interval to restore the restore the previous steering mode. <ul style="list-style-type: none"> • NAV mode: When the data from the helm sensor is not input for the set time, NAV mode is restored. • Other than NAV mode: When cruising straight ahead and the data from the helm sensor is not input for the set time, the previous steering mode is restored.
[Safe Helm Response]	Open the [Safe Helm Response] window to adjust safe helm response value. The higher the value the faster the response. <div style="display: flex; align-items: center;">  <div style="margin-left: 10px;"> <p>When you turn the helm, "PORT" or "STBD" appears according to the rudder direction.</p> </div> </div>
[Safe Helm Beep]	Turns the beep on or off when the safe helm mode is activated.

Power assist setup (for Accu-Steer FPS 12V (or 24V) drive)

Set up the power assist function from the [Power Assist Setup] menu. To open the [Power Assist Setup] menu, select [Power Assist Setup] from the [Dockside Setup] menu.

3. INITIAL SETTING

Note: The power assist setup cannot be performed if the safe helm test is not complete.

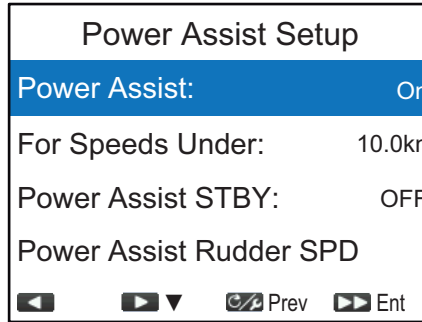

Menu item	Description
[Power Assist]	Turn the power assist mode on or off. The power assist mode, available with the Accu-Steer FPS 12V/24V type drive, customizes manual steering to your own preferences. The mode is available during the safe helm mode and the STBY mode.
[For Speeds Under]	Set the highest speed at which power assist activates. Note: When the power assist activates at high speed, the vessel may turn faster than intended. Set [For Speeds Under] according to the vessel and rudder feature.
[Power Assist STBY]	If you want power assist in the STBY mode, select [ON]. If not, select [OFF].
[Power Assist Rudder SPD]	Open the [Power Assist Rudder SPD] window to set the rudder speed when the power assist activates. The higher the setting, the stronger the power assist. Following display example is for the Fantum Feedback™. When the RRU is installed, the appearance of the indicator at the bottom of the screen changes.

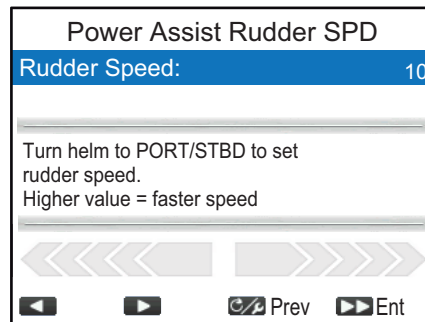

3.4.5 Confirmation of the dockside setup



After entering the dockside setup, confirm that the dockside setup is completed correctly, and the safe helm and power assist features work properly.

Confirmation of the rudder limit setup (when the RRU is installed)

Note: The following procedure is not required for Fantum Feedback™.

1. Show the rudder angle indicator.
2. Turn the helm hard-over to port at the dockside.
3. Confirm that the rudder angle indicator shows the value set at [STBD Limit Setup].
4. Turn the helm hard-over to starboard at the dockside.
5. Confirm that the rudder angle indicator shows the value set at [PORT Limit Setup].

Confirmation of the rudder steering

1. Show the rudder angle indicator or steering direction indicator.
2. Select the AUTO mode at the dockside.
3. Press the  key to set course.
4. When the RRU is installed, confirm that the rudder turns to starboard with the rudder angle indicator. For Fantum Feedback™, confirm visually that the rudder turns to starboard.
5. Press the  to set course.
6. When the RRU is installed, confirm that the rudder turns to port with the rudder angle indicator. For Fantum Feedback™, confirm visually that the rudder turns to port.

Confirmation of the AUTO mode at sea

1. Select a safe area and cruise at low speed.
2. Select the AUTO mode and confirm that NAVpilot controls the vessel properly.

Helm sensor test

Note: Confirm that your boat is equipped with the Accu-Steer FPS 12V (or 24V) drive unit.

1. Long-press the  key to open the menu, then select [Other Menu] → [System Setup] → [Diagnostics] → [Helm Sensor Test].
2. Perform the helm sensor test, referring to page 3-14.

Confirmation of the power assist feature activation

Note: When [Power Assist] is set to [ON], do the following procedure.

1. When [Power Assist STBY] is set to [ON] on the [Power Assist Setup] menu, select the STBY mode. When [Power Assist STBY] is set to [OFF], select the AUTO mode.
2. Turn the helm to starboard slowly, and then confirm that the power assist is activated and the rudder turns to starboard.
3. Turn the helm to port slowly, and then confirm that the power assist is activated and the rudder turns to port.

Confirmation of the safe helm and power assist features

Note: When [Safe Helm] and [Power Assist] is set to [ON], do the following procedure.

1. Select a safe area and cruise at minimum speed.
2. Select the AUTO mode.
3. Turn the helm and adjust the response at [Safe Helm Response].
4. While turning the helm, confirm that the power assist feature does not work too strongly. If necessary, adjust the value at [Power Assist Rudder Speed].
5. Center the rudder and stop steering. Then the steering mode is changed to the AUTO mode automatically. Adjust the return delay at [Return Delay].
6. Set the ship's speed to the value set at [For Speeds Under].

3. INITIAL SETTING

7. Turn the helm, and then confirm that the safe helm and power assist feature activate correctly.
Note: Do not turn the helm rapidly. If the power assist feature works strongly, the vessel may turn faster than intended.
8. Turn the helm and adjust the response at [Safe Helm Response].
9. When it is difficult to cruise at the speed set at step 6, adjust the setting value at [For Speeds Under] so that you can control the vessel easily.

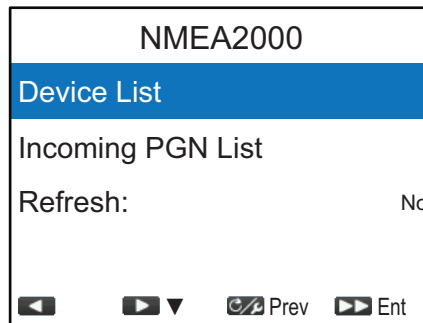

3.5 [NMEA2000] Menu

The [NMEA2000] menu sets up the equipment connected to the NMEA2000/CAN bus network. To open the [NMEA2000] menu, select [NMEA2000] from the [Installation Menu].

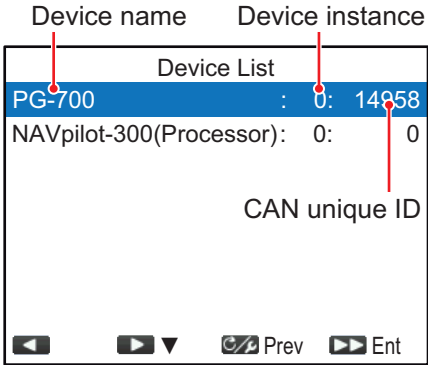
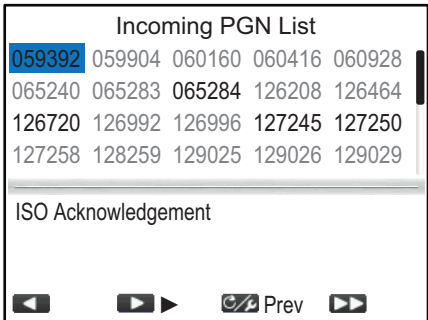

Note: When using GPS data, your NAVpilot requires the input of PGN 129029. Make sure that the required PGN is output from other equipment on the same network.

Menu item	Description
[Device List]	<p>Shows a list of devices connected to the same NMEA2000/CAN bus network as the NAVpilot.</p> 
[Incoming PGN List]	<p>Shows a list of PGNs that the NAVpilot is capable of receiving. Items in the PGN list which are available shown in black, unavailable items are shown in gray.</p> 

Menu item	Description
[Refresh]	Refreshes the items displayed in the [Device List] and [Incoming PGN List]. The lists should be refreshed when devices are added or removed from the same NMEA2000 network. To refresh the lists, select [Refresh] and press the  key. Then, select [Yes] and press the  key.

3.6 [Drive by Wire Port] Menu

You can check the incoming data from the DBW (Drive by Wire) port on the [Drive by Wire Port] menu. To open the [Drive by Wire Port] menu, select [Drive by Wire Port] from the [Installation Menu].

Note: [Drive by Wire Port] is appear on [Installation Menu] only when [Boat Type] is set to [EVCS-Pod Drive], [EVCS-Outboard], [EVCS-In/Out] or [EVCS-Inboard] on the [Ship's Characteristics] menu.

Select [Incoming Data] to monitor the incoming data. Items in the [Incoming Data] list which are available shown in black, unavailable items are shown in gray.

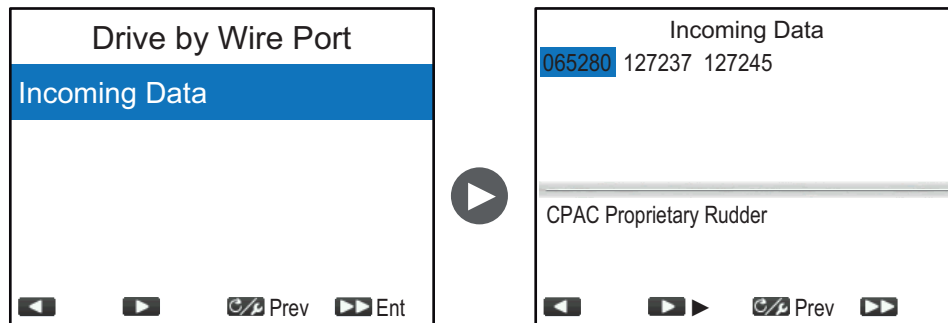

3.7 [Sensors Selection] Menu

The [Sensors Selection] menu selects the data source for the heading, STW, SOG and position data. Also, you can open the [View Sensors in Use] display from the [Sensors Selection] menu. The [View Sensors in Use] display shows a list showing the sensors currently used as the data source. To open the [Sensors Selection] menu, select [Sensors Selection] from the [Installation Menu].

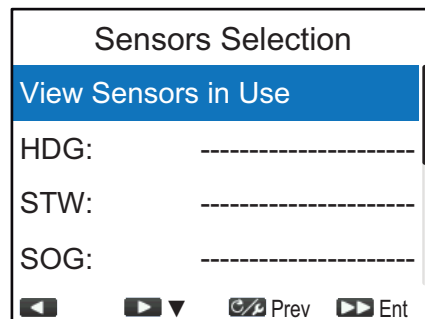

[View Sensors in Use] display

The [View Sensors in Use] display shows a list showing the sensors currently used as the data source. To open the [View Sensors in Use] display, select [View Sensors in Use] from the [Sensors Selection] menu, then press the  key.

3. INITIAL SETTING

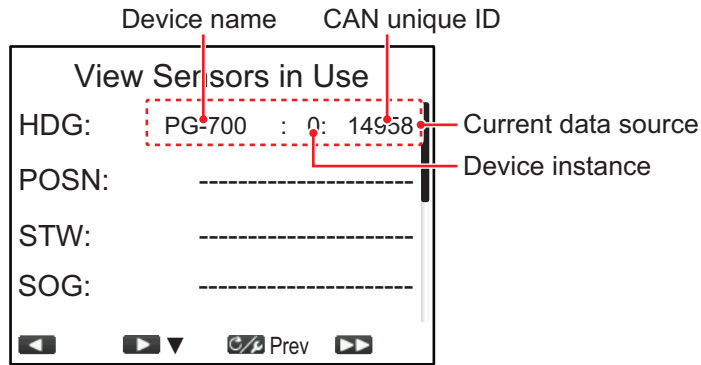

Dashed lines "-----" indicate that either there is no connection, or the sensor is not currently active.





To close the [View Sensors in Use] display, press the  key

How to select the data source

In default, the NAVpilot automatically detects and connects to data sources with in the network. If you want to use a specific sensor as the data source, do the following procedure:

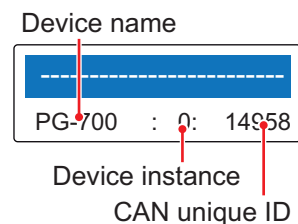
1. Turn on all sensors connected to the NAVpilot.
2. Press the  or  key to select the data from the [Sensors Selection] menu, then press the  key. The data source selection window appears. The display example shown to the right is the data source selection window for the heading data.



3. Press the  or  key to select the sensor, then press the  key.

When "-----" is selected, the NAVpilot automatically detects and connects to data sources within the network.

Note: [Not used] is shown in the data selection window for the STW data. When [Not used] is selected, the NAVpilot does not use STW data.

4. Press the  key to close the [Sensors Selection] menu and go back to the [Installation Menu].

3.8 [Sea Trial] Menu

Settings on the [Sea Trial] menu require taking the vessel on a short sea trial. This requires the vessel to leave the dock. To open the [Sea Trial] menu, select [Sea Trial] from the [Installation Menu].

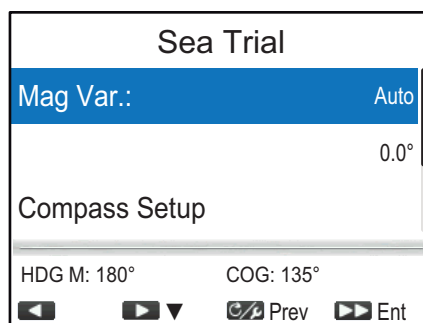

3.8.1 Setting for magnetic variation information ([Mag. Var.])

With a magnetic heading sensor (PG-500/PG-700, etc.), magnetic variation information is necessary to display true heading data. In almost all cases, a GPS will be connected to the NAVpilot and the GPS will send this variation information to the NAVpilot automatically. Therefore, set [Mag. Var.] to [Auto]. In special cases where a manual variation is required, you may input these values manually. Note that this selection is only effective when [Heading Display] is set to [True] on the [Display Setup] menu.

When [Heading Display] is set to [True] on the [Display Setup] menu, the NAVpilot will display true heading information even though the NAVpilot may be connected to a magnetic heading sensor. This is very valuable when connecting a FURUNO FAR-21×7 series radar to the NAVpilot because these radars can not be set for a magnetic heading input and the “Waypoint Lollipop” will only align properly when true heading is used.

3.8.2 How to calibrate the heading sensor ([Compass Setup] menu)

You can calibrate the connected heading sensor (FURUNO PG-700 or SC-30) from the [Compass Setup] menu.

- This procedure is not applicable to heading sensors other than PG-700 and SC-30.
- It is not necessary to perform any adjustments locally at the PG-700 or SC-30. NAVpilot has full control of these heading sensors.

To open the [Compass Setup] menu, select [Compass Setup] from the [Sea Trial] menu. The items on the [Compass Setup] menu change according to the heading sensor (PG-700 or SC-30). The following display example is for the PG-700.

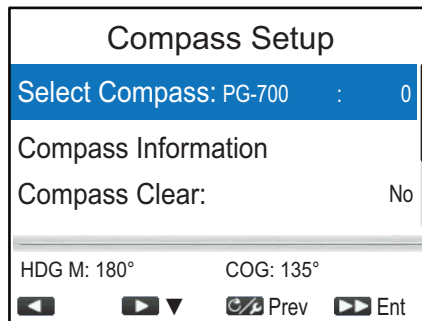

Menu item	Description
[Select Compass]	Select the heading sensor to setup.
[Compass Information]	Show the model name and software version of the sensor. <div style="border: 1px solid black; padding: 5px; margin: 5px 0;"> <p style="text-align: center;">Compass Information</p> <p>Model ID: PG-700</p> <p>Software Version: 01.02:02.02</p> </div>

3. INITIAL SETTING

Menu item	Description
[Compass Calib.]* ¹	<p>Select the calibration mode.</p> <ul style="list-style-type: none"> [No]: Calibration is not performed. [Auto]: The boat turns to starboard about three or four full circles for calibration. Note that the boat will turn to starboard with the degree set at [Manual Rudder Limit] on the [Rudder Limit Setup] menu. For the EVC system equipped boats, the boat will turn to starboard with 26°. <p>Note: [Auto] is not shown for Fantum Feedback™.</p> <ul style="list-style-type: none"> [Manual]: Use the helm to turn the boat to port or starboard for three or four full circles in a speed of about one minute/circle to perform the calibration.
[WAAS Mode]* ²	<p>Turn on/off the WAAS (SBAS) satellite search.</p> <ul style="list-style-type: none"> [Auto]: Search the WAAS (SBAS) satellite automatically. [SBAS OFF]: Disable WAAS (SBAS) position fixing.
[Compass Offset]* ^{1,2}	<p>If the heading data shown on the display differs from the indication of the heading sensor, apply an offset at [Compass Offset]. This offset is applied to the heading sensor data. For example, if the indication on the control unit shows 125° though the heading sensor reading is 120°, enter "5°"</p>
[Compass Clear]* ¹	<p>Select [Yes] to restore sensor's factory defaults. For recalibrating the heading sensor.</p>
[Restart PG-700]* ¹	<p>Select [Yes] to restart the PG-700. Turn the steering mode to the STBY mode before restarting the PG-700.</p>
[Pitch Offset]* ²	<p>Offset the pitch value.</p>
[Roll Offset]* ²	<p>Offset the roll value.</p>



*1: Shown when PG-700 is selected at [Select Compass].



*2: Shown when SC-30 is selected at [Select Compass].

3.8.3 How to set the center rudder position in cruising

Do the following procedure to set the rudder position at 0° in a normal cruising speed. If this setting is not completed, the boat may wander. For dual-engine boats, be sure that the engines are synchronized and maintain a normal cruising speed.

Note: When the rudder reference unit is not installed or the boat is equipped the EVC system, the following procedure is unnecessary.











1. Press the  key to select [Set Center Rud. Pos.] from the [Sea Trial] menu, then press the  key.
The following message appears.

Follow a straight course
and press [10>>] to set
Are you sure?
 Yes
 No

2. Turn the helm so that the rudder is centered, then run the boat between 10 to 15 knots.
3. Press the  key while the boat runs straight to set the center rudder position in cruising.

3.8.4 How to set the rudder deadband









You can set the rudder deadband automatically or manually.

1. Press the  key to select [Rudder Dead Band] from the [Sea Trial] menu, then press the  key.
2. Press the  or  key to select [Manual] or [Auto], then press the  key.
3. For Manual, do as follows:
 - 1) Press the  key to select the current deadband value, then press the  key.
 - 2) Press the  or  key to adjust the deadband value, then press the  key.

Note: When the rudder test is performed after setting the rudder deadband manually, set the rudder deadband again.





3.8.5 How to set the ship's speed

Do as follows to set ship's speed.

1. Press the  key to select [Boat Speed Settings] from the [Sea Trial] menu, then press the  key.
2. Press the  or  key to select [Set Max Speed] or [Set Planing Speed], then press the  key.
3. Press the  or  key to adjust the value, then press the  key.

3.8.6 How to offset the STW value

Do as follows to apply an offset to the STW data.

1. Press the  key to select [STW Adjust] from the [Sea Trial] menu, then press the  key.
2. Press the  or  key to adjust offset value, then press the  key.
Enter a 99% or below when the indication is higher than the actual value; 101% or more when it is lower than the actual value. If the indication on the display shows the current value, keep the setting at "100%".

3.9 [Parameter Setup] Menu

The NAVpilot has an automatic adjustment feature which sets up the equipment according to ship's characteristics and sea state, for optimum performance in vessel control. In addition, a self-learning algorithm is incorporated; Parameters for rudder ratio, counter rudder and auto trim gain are constantly optimized based on the steering history of your boat, and are stored in memory for future navigation.

3. INITIAL SETTING

Set how the NAVpilot steers your boat on the [Parameter Setup] menu as follows: To open the [Parameter Setup] menu, select [Parameter Setup] from the [Installation Menu].

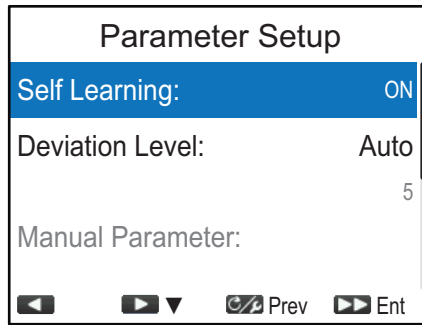

Menu item	Description
[Self Learning]	Activate/deactivate the NAVpilot self-learning feature. The self-learning feature adjusts parameters for rudder ratio, counter rudder and auto trim gains are constantly optimized based on the steering history of your boat, and are stored in memory for future navigation.
[Deviation Level]	You can set the deviation level automatically or manually. Select [Manual] to set the deviation level manually, then enter the deviation level value. A lower value keeps the course more precisely but the rudder may be turned more often. With a higher value, the rudder is fixed, but the course may not be kept as precisely. Note: Set [Self Learning] to [ON] to adjust [Deviation Level].
[Manual Parameter]	Open the [Manual Parameter] menu and adjust the steering parameters manually. <div data-bbox="788 1122 1214 1435" data-label="Image"> </div> <p>For the detailed information about each setting items, see "Guidelines for how to adjust the steering parameters manually" on page 3-24. Note: Set [Self Learning] to [OFF] to adjust [Manual Parameter].</p>
[Speed Calculation]	Speed is normally entered automatically from your navigator. If the navigator fails, enter the speed manually. When you enter the speed manually, set [Speed Calculation] to [Manual], then enter the ship's speed value.

Guidelines for how to adjust the steering parameters manually

- **[Weather]:** When the sea is rough, the boat's heading fluctuates to port and starboard. If the rudder is driven very often to maintain the set course, the helm mechanism may wear out. To prevent this, the weather adjustment makes the NAVpilot insensitive to minute course deviations. Until the course deviation exceeds the selected setting, steering to correct the heading will not be initiated.

The following illustration shows boat's track lines with weather setting 3° and 7°. When 7° is set, for example, the rudder is not driven until the course deviation exceeds 7°. Increasing the setting reduces activation of the steering gear, however the boat tends to zigzag. When the sea is calm, set a smaller value.

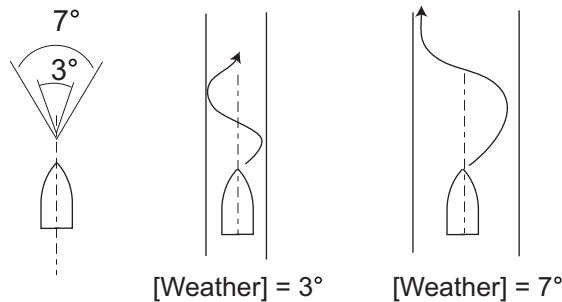

- **[Rudder Gain]:** When the boat's heading deviates from the set course, the NAVpilot adjusts the rudder to correct it. The rudder angle (number of degrees) which is steered against every degree of course deviation is known as the rudder gain. Set the rudder gain so that the boat does not make frequent yaw. The following figure provides general guidelines for setting the rudder gain.

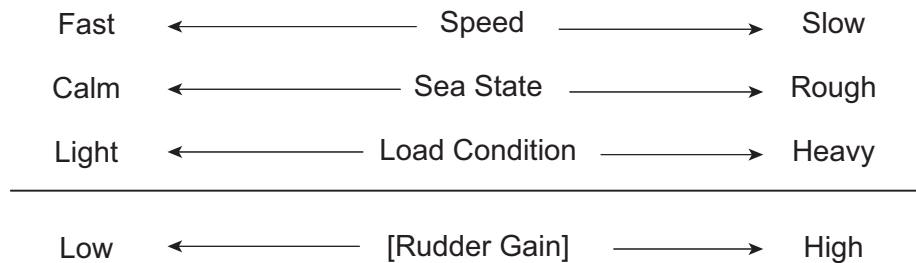

- **[Counter Rud.]:** If the boat is heavily loaded, the heading could change excessively because of inertia. This phenomenon causes the vessel to "overshoot" the intended course. If this happens, the NAVpilot will steer the rudder to the opposite side and the heading will turn in the opposite direction excessively again. In an extreme case the heading oscillates several times until it finally settles in the new course. An adjustment known as "counter rudder" prevents this kind of oscillation. Counter rudder is usually not required for small boats. When your boat zigzags a lot before settling in the new course, increase the counter rudder setting.

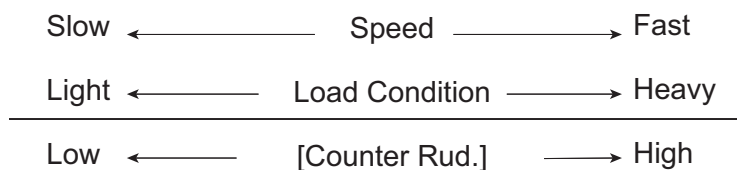
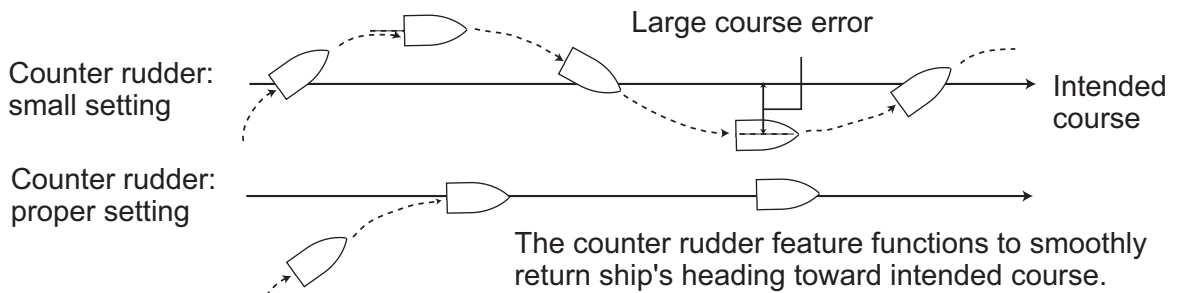

3. INITIAL SETTING

- **[Manual Trim]:** This setting compensates for yaw caused by rough seas or heavy loads. If the boat has a port-side yaw, adjust the trim to starboard. Alternatively, if the boat has a starboard-side yaw, adjust the trim to port.



Note: For boats with Fantum Feedback™, [Manual Trim] settings are not used. The menu items is available, however any change in settings is ignored.

3.10 [Auto Pilot Option] Menu

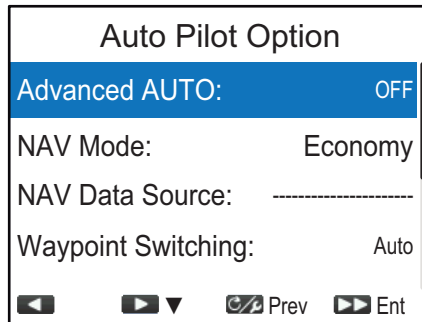
The features for the AUTO and NAV modes are set up from the [Auto Pilot Option] menu. To open the [Auto Pilot Option] menu, select [Auto Pilot Option] from the [Installation Menu].



Menu item	Description
[Advanced AUTO]	The AUTO mode will maintain a set course, but your vessel's course may be shifted by the effects of tide and wind. To compensate for the effects of tide and wind, set [Advanced AUTO] to [ON]. The NAVpilot must be connected to a GPS navigator which outputs position data (Latitude and Longitude) in NMEA2000/ CAN bus format.
[NAV Mode]	Your vessel may go off course when navigating between waypoints in the NAV mode. To get you back on course, two methods are available: [Precision] and [Economy]. [Precision] and [Economy] both use the XTE (cross-track error) value to steer the boat towards your original course before dodging. <ul style="list-style-type: none"> • [Precision]: Keeps the course within 0.01 NM. [Precision] provides for more precise steering than [Economy]. • [Economy]: Keeps the course within 0.03 NM. [Economy] provides for more economical steering than [Precision].
[NAV Data Source]	Opens the data source selection window and selects the source for nav data to use in the NAV mode. When "-----" is selected, the NAVpilot automatically detects and connects to data sources within the network. <p>Note: The XTE (Cross Track Error) resolution of the nav data source must be 0.001 NM or more precise. If not, the NAVpilot steering performance may be reduced.</p>
[Waypoint Switching]	When you arrive at a waypoint on a route in the NAV mode, you can switch to the next waypoint automatically or manually. <ul style="list-style-type: none"> • [Auto]: Switch to the next destination waypoint automatically when your boat is within the arrival alarm area (set on the chart plotter). • [Manual]: Requires operator confirmation (pressing the any key) before switching to the next waypoint.

Menu item	Description
[On Arrival]	Set how the boat is to be steered after arriving at the last waypoint in a route, in the NAV mode. <ul style="list-style-type: none"> • [Go Straight]: Cruise straight after arriving at the last waypoint. • [Orbit to PORT]: Orbits to PORT around waypoint. • [Orbit to STBD]: Orbits to STBD around waypoint. • [Figure Eight PORT]: Turns to PORT in a figure-eight pattern. • [Figure Eight STBD]: Turns to STBD in a figure-eight pattern. • [Point Lock]: Activates Point Lock™, which maintains a fixed boat position by controlling the rudder and throttle.
[Turn1 Angle]/ [Turn2 Angle]	Set the angle of User turn in the turn mode. <div style="display: flex; justify-content: space-around; margin-top: 10px;"> <div style="border: 1px solid black; padding: 5px; width: 45%;"> <p>[Turn1 Angle] setting is applied to the following two user turn icon.</p>  </div> <div style="border: 1px solid black; padding: 5px; width: 45%;"> <p>[Turn2 Angle] setting is applied to the following two user turn icon.</p>  </div> </div>
[Route Smoothing]	Sets deceleration control during change of the course and upon arrival at the final waypoint.
[Low Limit Speed]	Sets the speed of the lower limit to slow down.
[Deceleration Rate]	Sets deceleration rate on turning.

3.11 [Fish Hunter Option] Menu

The FishHunter™ mode is a unique feature of FURUNO NAVpilot series. Find a fish target with your FURUNO sonar/sounder or bird target with your FURUNO radar and feed it to the NAVpilot. The NAVpilot will activate the FishHunter™ mode to perform various turn around the specified target.

You can set the parameters for the FishHunter™ turns from the [Fish Hunter Option] menu. To open the [Fish Hunter Option] menu, select [Fish Hunter Option] from the [Installation Menu].

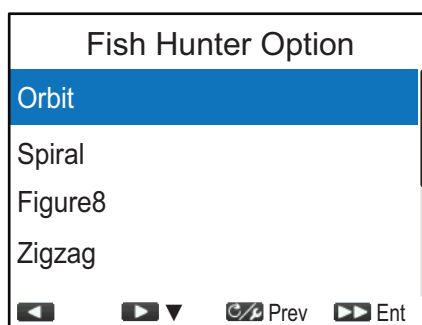

Set the parameters for each FishHunter™ turn referring to the following description.

3. INITIAL SETTING

Orbit turn

Your boat orbits around its current position. This function requires a chartplotter or GPS navigator.

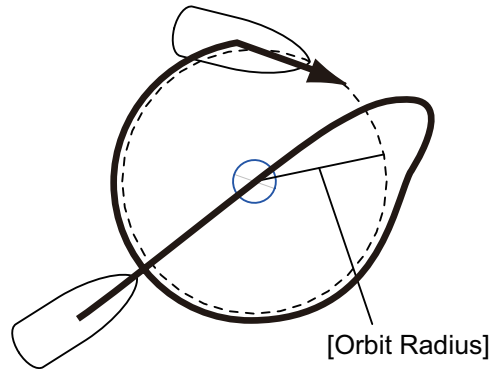
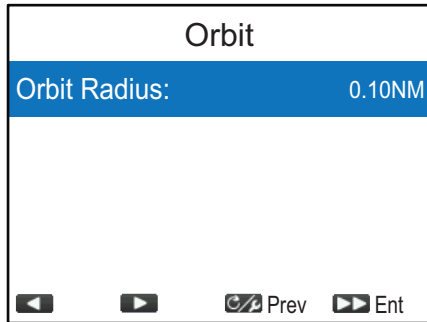

Spiral turn

The boat spirals in the direction of current heading (STBY), set course (AUTO) or the course to the next waypoint (NAV) that was active at the moment that the spiral turn is started.

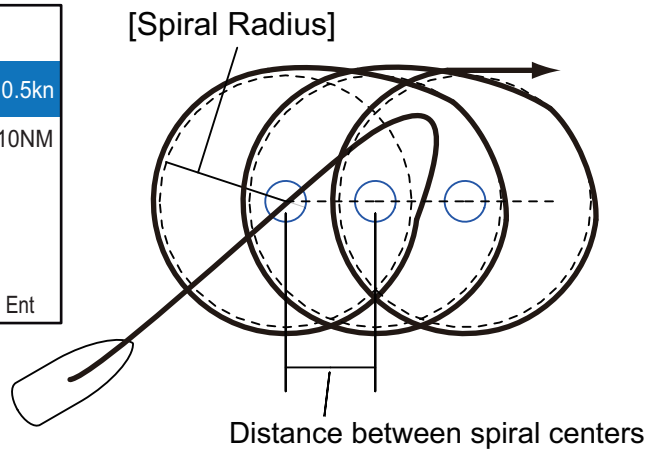
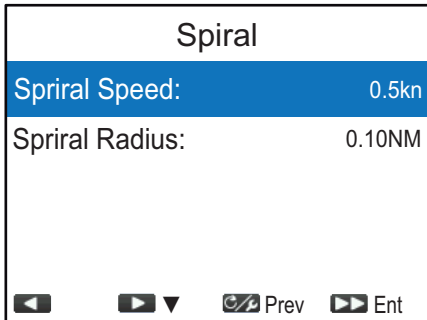

$$\text{Distance between spiral centers (NM)} = \frac{6.28 \times [\text{Spiral Radius}]}{[\text{Spiral Speed}]}$$

Note: In the NAV mode, if the boat does not enter the arrival alarm area, the NAVpilot does not switch to the next waypoint. To prevent this, set the arrival alarm range as large as possible and activate the perpendicular function on the chartplotter.

Figure8 turn

After the boat has traveled the radius set on the menu, it starts turning in a figure-eight pattern, automatically returning to the position where the figure-eight was initiated.

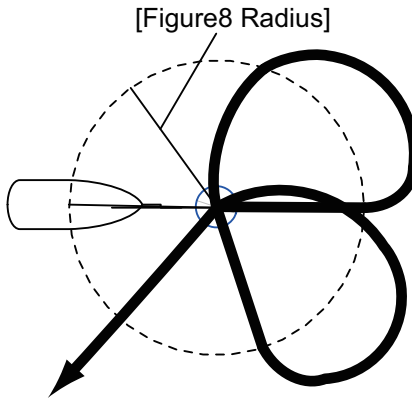
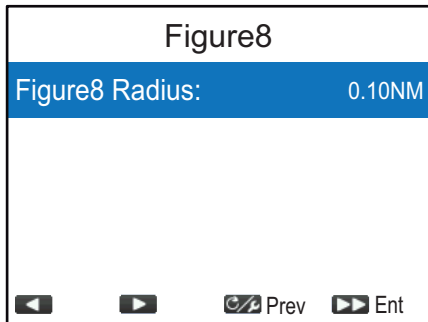

Zigzag turn

The zigzag turn starts from current position. The distance between legs and turn angle can be set on the menu. This turn is available in the AUTO and NAV modes.

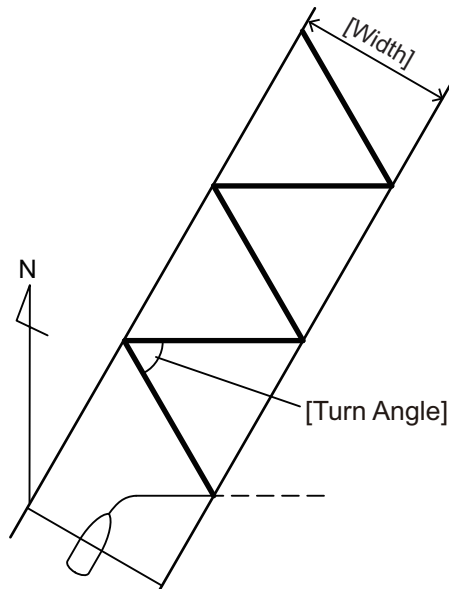
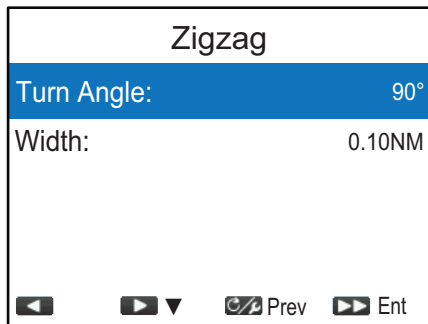

SABIKI™ mode

Note: This menu item is not shown when [Boat Type] is set to [Inboard], [EVCS-Pod Drive] or [EVCS-Inboard] on the [Ship's Characteristics] menu.



The SABIKI™ mode controls the rudder while the vessel is using reverse thrust, effectively keeping the stern facing windward (or into the current) while keeping the bow leeward (or with the current).

Due to the SABIKI™ mode's ability to control the rudder, only the throttle requires periodic adjustment to keep the vessel facing in the same direction. The reduction of required adjustments allows

you to focus more on fishing, even with a light crew on-board.

3. INITIAL SETTING

When any of the following cases occur, adjust [SABIKI Response].

When the SABIKI™ mode over-corrects the direction.	Increase the [SABIKI Response] value. If the direction is over-corrected with this setting, decrease reverse throttle.
Where the SABIKI™ mode under-corrects direction.	Decrease the [SABIKI Response] value. If the direction is under-corrected with this setting, increase reverse throttle.

SABIKI Lock™

Note: This menu does not appear when [Fish Hunter Drive] is set to [Off].

SABIKI Lock™ adds automatic throttle operation to the SABIKI™ mode.

When any of the following cases occur, adjust [Sensitivity].

When the SABIKI™ mode over-corrects the direction.	Increase the [Sensitivity] value.
If the direction is under-corrected.	
When the SABIKI™ mode under-corrects direction.	Decrease the [Sensitivity] value.
If the direction is over-corrected.	

Point Lock™

Note: This menu does not appear in the below cases.

- When the [Fish Hunter Drive] is set to OFF.
- When the [Fish Hunter Drive] is set to ON, but [Rudder Sensor] is set to [Fantom Feedback].

This function holds the vessel in a set position, preventing it from being swept away when stopped.





When any of the following cases occur, adjust [Sensitivity].

When the ship moves away from the center point of the control unit.	Decrease the [Sensitivity] value.
When the shift F / R is switched frequently.	Increase the [Sensitivity] value.
When the shift shock is heavy	

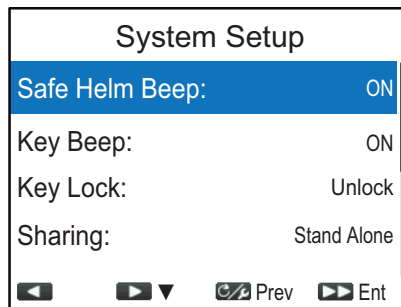
3.12 [System Setup] Menu

The [System Setup] menu sets system settings such as key beep, network shared settings, etc. To open the [System Setup] menu, select [System Setup] from the [Installation Menu].



Menu item	Description
[Safe Helm Beep]	<p>[Safe Helm Beep] is shown under the following conditions:</p> <ul style="list-style-type: none"> [Boat Type] is set to [EVCS-Pod Drive], [EVCS-Outboard], [EVCS-In/Out] or [EVCS-Inboard] on the [Ship's Characteristics] menu on the [Ship's Characteristics] menu. NAVpilot is connected with the Dometic Optimus system. <p>Enables or disables the beep sound released when the system switches to OVRD (override) mode. [ON]: The beep sounds, [OFF]: No beep</p>
[Key Beep]	<p>Turn the key beep on or off. [ON]: The key beep sounds, [OFF]: No key beep</p>
[Key Lock]	<p>Activate or deactivate the control unit key lock.</p> <ul style="list-style-type: none"> [Lock]: Keys are locked. When any key other than the  key is pressed on the locked control unit, the message shown to the right appears. Also, the lock icon () appears. <p>To unlock, press the  key while holding down the  key. If the locked the control unit is powered off, the next time the control unit is powered, the control unit keys are locked.</p> <ul style="list-style-type: none"> [Unlock]: Keys are not locked. <div style="border: 1px solid black; padding: 5px; width: fit-content;"> <p>This controller is locked. To unlock, hold [menu] key down and press [10>>] key.</p> </div>
[Sharing]	<p>The following installation settings, made on a master unit within the network are passed onto the sub units on the same network.</p> <ul style="list-style-type: none"> Data source settings on the [Sensors Selection] menu (see section 3.7) Speed and range unit setting on the [Unit] menu (see page 3-2) [Heading Display] setting on the [Display Setup] menu (see section 3.2) [Time Offset] setting on the [Display Setup] menu (see section 3.2) [Mag. Var.] setting on the [Sea Trial] menu (see section 3.8.1) [STW Adjust] setting on the [Sea Trial] menu (see section 3.8.1) <p>Select the appropriate sharing level from the following options.</p> <ul style="list-style-type: none"> [Stand Alone]: Disables sharing of settings. [Sub]: Assign the control unit as a sub unit. [Master]: This unit's settings are passed to all sub units. Where a FURUNO multi function display (MFD) is in the same network, the MFD is automatically assigned as the [Master] and this option is not available.

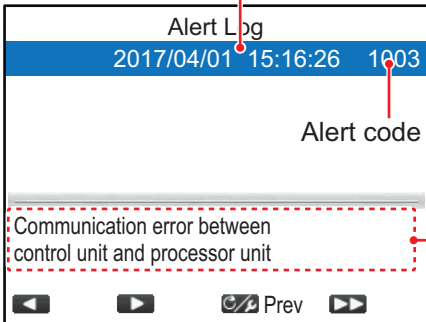
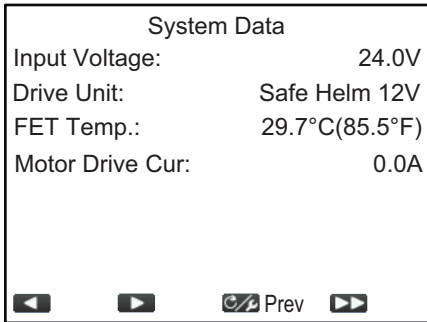

3. INITIAL SETTING

Menu item	Description
[Group]	The language and brilliance settings are shared within a group of NAVpilot-300 control units and FI-70s. If these settings are adjusted for one control unit or FI-70 in the group, all other units in the same group are also adjusted, however MFD settings are not adjusted. There are three groupings available: [A], [B] and [C]. Select an appropriate group to assign a group to a control unit.
[Factory Default]	Select [Yes] to restore factory default settings. The system is automatically restarted after selecting [Yes].
[Save User Settings]	Select [Yes] to save the current settings as user default settings to the internal memory. The user default settings in the internal memory are overwritten with the current settings.
[Load User Settings]	Select [Yes] to load the setting data from the internal memory. The current settings will be overwritten with the user default settings in the internal memory.
[Alert Log]	<p>You can see which alert(s) has(have) been violated. A maximum of 10 alerts are listed. When the capacity is exceeded, the oldest alert is deleted to make a room for the latest.</p> <p style="text-align: center;">Occurred date and time</p> <div style="text-align: center;">  <p style="margin-left: 100px;">Alert code</p> <p style="margin-left: 150px;">Alert description</p> </div>
[Sim/Slide]	Activate or deactivate the simulation mode. DO NOT select the option other than [OFF] on board your boat. The options other than [OFF] are intended for use in service or promotion purposes.
[Diagnostics]	Perform various diagnostics on the NAVpilot system. Available in the STBY mode only. For details, see the operator's manual (OME-72840).
[System Data]	<p>Show system data.</p> <div style="text-align: center;">  </div> <ul style="list-style-type: none"> • [Input Voltage]: Voltage input to the NAVpilot. • [Drive Unit]*: Drive type used with the NAVpilot. • [FET Temp.]*: Temperature of the circuit board in the processor unit. • [Motor Drive Cur]*: Motor drive current. <p>*: Not shown for the EVC system equipped vessel.</p>



3.13 Pairing the Gesture Controller ([Wireless RC] Menu)

The processor unit communicates with the gesture controller (GC-001), via Bluetooth®. A maximum of three GC-001s can be connected to the processor unit.?

Pair the gesture controller to the processor unit from the [Wireless RC] menu.

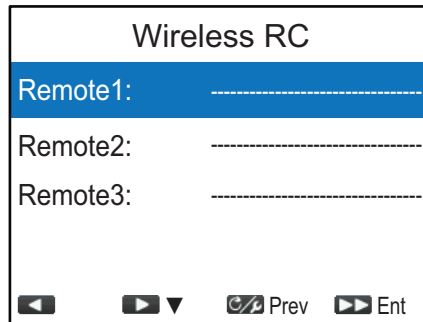
1. Press the  key to select [Wireless RC] from the [Installation Menu], then press the  key.





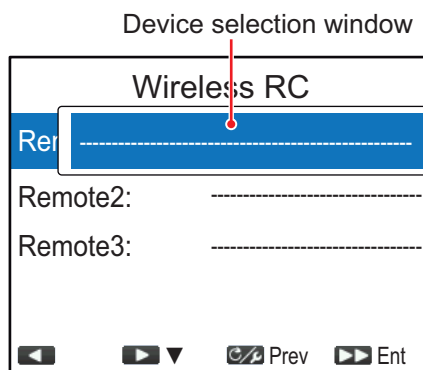

2. Press the  or  key to select [Remote1], [Remote2] or [Remote3], then press the  key.
The device selection window appears.



3. On your gesture controller, do the following procedure to activate the pairing mode.



- 1) Long press the  key to turn the GC-001 on.
- 2) Press the  key to open the menu.
- 3) Select [SYSTEM MENU], then press the  key.
- 4) Select [PAIRING], then press the  key.
- 5) Select [YES], then press the  key.

The pairing mode is activated and the message "PAIRING..." appears on the GC-001. After activating the pairing mode on the GC-001, the device name will be shown on the device selection window on the control unit.

3. INITIAL SETTING

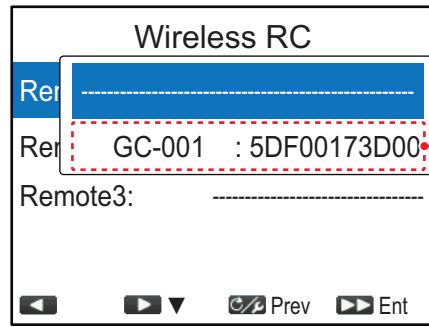

Device name appears after activating the pairing mode on the GC-001.

- Press the key to select the GC-001 on the device selection window, then press the key. After completing the pairing, the STBY mode window appears on the GC-001.

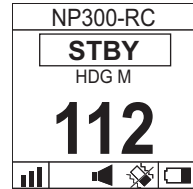

Note 1: If the GC-001 to be paired is not selected within 20 seconds, the message "TIME OUT!" appears on the GC-001 and the device selection window closes on the NAVpilot-300. In this case, activate the pairing mode again on the GC-001, then select the GC-001 on the device selection window.

Note 2: When pairing with a GC-001 that does not support FishHunter™ Drive, the message will appear to update the GC-001.

3.14 [Alert] Menu

All alert settings are done from the [Alert] menu. To open the [Alert] menu, select [Alert] from the [Installation Menu].

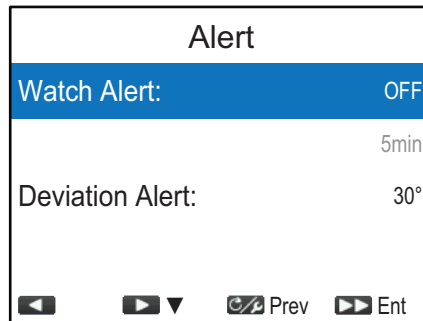

Menu item	Description
[Watch Alert]	The watch alert periodically warns the helmsman to check the NAVpilot when in the AUTO or NAV mode. Select [ON] to activate the watch alert, then enter the time interval. If the set time passes without operation the buzzer sounds and the message "Watch Alert!" appears. Further, if three minutes elapses after the watch alert has sounded, the alert becomes louder. Press any key to stop the alert.
[Deviation Alert]	The deviation alert sounds in the AUTO and NAV modes when the heading deviates more than the deviation alert value. Note 1: The setting value of the deviation alert can be changed, but you cannot deactivate this alert. Note 2: When the NAVpilot cannot move the rudder with Fantum Feedback™, the deviation alert sounds regardless of the setting value, In this case, switch to the STBY mode and turn the helm to move the rudder.

APPX. 1 JIS CABLE GUIDE

Cables listed in the manual are usually shown as Japanese Industrial Standard (JIS). Use the following guide to locate an equivalent cable locally.

JIS cable names may have up to 6 alphabetical characters, followed by a dash and a numerical value (example: DPYC-2.5).

For core types D and T, the numerical designation indicates the *cross-sectional Area (mm²)* of the core wire(s) in the cable.

For core types M and TT, the numerical designation indicates the *number of core wires* in the cable.

1. Core Type

D: Double core power line

T: Triple core power line

M: Multi core

TT: Twisted pair communications
(1Q=quad cable)

2. Insulation Type

P: Ethylene Propylene Rubber

3. Sheath Type

Y: PVC (Vinyl)

4. Armor Type

C: Steel

5. Sheath Type

Y: Anticorrosive vinyl sheath

6. Shielding Type

SLA: All cores in one shield, plastic tape w/aluminum tape

-SLA: Individually shielded cores, plastic tape w/aluminum tape

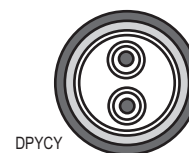

DPYCY



TPYCY



MPYC-4



TTYCSLA-4

EX: ¹ ³ ⁴ ⁵ ⁶
TTYCYSLA - 4
 Designation type | # of twisted pairs

EX: ¹ ² ³ ⁴
MPYC - 4
 Designation type | # of cores

The following reference table lists the measurements of JIS cables commonly used with Furuno products:

Type	Core Area	Core Diameter	Cable Diameter	Type	Core Area	Core Diameter	Cable Diameter
DPYC-1.5	1.5mm ²	1.56mm	11.7mm	TTYCSLA-1	0.75mm ²	1.11mm	9.4mm
DPYC-2.5	2.5mm ²	2.01mm	12.8mm	TTYCSLA-1T	0.75mm ²	1.11mm	10.1mm
DPYC-4	4.0mm ²	2.55mm	13.9mm	TTYCSLA-1Q	0.75mm ²	1.11mm	10.8mm
DPYC-6	6.0mm ²	3.12mm	15.2mm	TTYCSLA-4	0.75mm ²	1.11mm	15.7mm
DPYC-10	10.0mm ²	4.05mm	17.1mm	TTYCY-1	0.75mm ²	1.11mm	11.0mm
DPYCY-1.5	1.5mm ²	1.56mm	13.7mm	TTYCY-1T	0.75mm ²	1.11mm	11.7mm
DPYCY-2.5	2.5mm ²	2.01mm	14.8mm	TTYCY-1Q	0.75mm ²	1.11mm	12.6mm
DPYCY-4	4.0mm ²	2.55mm	15.9mm	TTYCY-4	0.75mm ²	1.11mm	17.7mm
MPYC-2	1.0mm ²	1.29mm	10.0mm	TTYCY-4SLA	0.75mm ²	1.11mm	19.5mm
MPYC-4	1.0mm ²	1.29mm	11.2mm	TTYCYSLA-1	0.75mm ²	1.11mm	11.2mm
MPYC-7	1.0mm ²	1.29mm	13.2mm	TTYCYSLA-4	0.75mm ²	1.11mm	17.9mm
MPYC-12	1.0mm ²	1.29mm	16.8mm	TTPYCSLA-1	0.75mm ²	1.11mm	9.2mm
TPYC-1.5	1.5mm ²	1.56mm	12.5mm	TTPYCSLA-1T	0.75mm ²	1.11mm	9.8mm
TPYC-2.5	2.5mm ²	2.01mm	13.5mm	TTPYCSLA-1Q	0.75mm ²	1.11mm	10.5mm
TPYC-4	4.0mm ²	2.55mm	14.7mm	TTPYCSLA-4	0.75mm ²	1.11mm	15.3mm
TPYCY-1.5	1.5mm ²	1.56mm	14.5mm				
TPYCY-2.5	2.5mm ²	2.01mm	15.5mm				
TPYCY-4	4.0mm ²	2.55mm	16.9mm				

This page is intentionally left blank.

PACKING LIST NAVPILOT-300**A

648C-X-9852-4

1/1

A-1

NAME	OUTLINE	DESCRIPTION/CODE No.	Q'TY
ユニット			
制御部		FAP-3012	1
PROCESSOR UNIT		000-033-334-00	
操作部		FAP-3011	1
CONTROL UNIT		000-033-332-00	
ジェスチャーコントローラ		GC-001	1
GESTURE CONTROLLER		000-033-745-00	
予備品			
予備品		SP64-01701	1
SPARE PARTS		001-485-540-00	
付属品			
付属品		FP64-01501	1
ACCESSORIES		001-482-130-00	
工事材料			
ケーブル(クミヒン)		FI-70-0600	1
CABLE ASSEMBLY		000-194-061-10	
工事材料		CP26-02001	1
INSTALLATION MATERIALS		001-336-500-00	

コード番号末尾の[**]は、選択品の代表型式/コードを表します。
 CODE NUMBER ENDING WITH "**" INDICATES THE CODE NUMBER OF REPRESENTATIVE MATERIAL.

(*1)は、それぞれ仕様選択品を表します。

(*1)INDICATE SPECIFICATION SELECTIVE ITEM.

(略図の寸法は、参考値です。DIMENSIONS IN DRAWING FOR REFERENCE ONLY.)

NAME	OUTLINE	DESCRIPTION/CODE No.	Q'TY
工事材料		CP64-02501	1
INSTALLATION MATERIALS		009-000-880-00	
工事材料		CP64-03401	1
INSTALLATION MATERIALS		001-472-330-00	
図書			
フラッシュカード型紙		C72-01602-*	1
FLUSH MOUNTING TEMPLATE		000-193-299-1*	
ユーザガイド		C72-01603-*	1
USER'S GUIDE		000-193-300-1*	
取扱説明書		OM*-72840-*	1
OPERATOR'S MANUAL		000-193-294-1* (**)	
取付要領書		C72-01604-*	1
INSTALLATION INSTRUCTIONS		000-193-301-1*	
操作要領書(和)		OSJ-72840-*	1
OPERATOR'S MANUAL (JP)		000-193-363-1* (*1)	
装備要領書		IM*-72840-*	1
INSTALLATION MANUAL		000-193-296-1* (**)	

C7284-Z02-E

PACKING LIST
NAVPILLOT-300-E-RN

64BC-X-9853 -2 1/1
A-2

NAME	UNIT	OUTLINE	DESCRIPTION/CODE No.	Q'TY
制御部 PROCESSOR UNIT			FAP-3012 000-033-334-00	1
操作部 CONTROL UNIT			FAP-3011 000-033-332-00	1
予備品 SPARE PARTS				
予備品 SPARE PARTS			SP64-01701 001-485-540-00	1
工事材料 INSTALLATION MATERIALS				
ケーブル & (フイビシ) CABLE ASSEMBLY			F1-70-0600 000-194-061-10	1
工事材料 INSTALLATION MATERIALS			CP26-02001 001-336-500-00	1
工事材料 INSTALLATION MATERIALS			CP64-02501 009-000-880-00	1
工事材料 INSTALLATION MATERIALS			CP64-03401 001-472-330-00	1
図書 DOCUMENT				
フラッシュマウント型紙 FLUSH MOUNTING TEMPLATE			C72-01602-* 000-193-299-1*	1
取付要領書 INSTALLATION INSTRUCTIONS			C72-01604-* 000-193-301-1*	1
装填要領書 INSTALLATION MANUAL			IM*-72840-* 000-193-296-1*	1

(略図の寸法は、参考値です。 DIMENSIONS IN DRAWING FOR REFERENCE ONLY.)

C7284-Z03-C

PACKING LIST
NAVPILLOT-300-N

64BC-X-9851 -1 1/1
A-3

NAME	UNIT	OUTLINE	DESCRIPTION/CODE No.	Q'TY
制御部 PROCESSOR UNIT			FAP-3012 000-033-334-00	1
予備品 SPARE PARTS				
予備品 SPARE PARTS			SP64-01701 001-485-540-00	1
工事材料 INSTALLATION MATERIALS				
工事材料 INSTALLATION MATERIALS			CP64-02501 009-000-880-00	1
図書 DOCUMENT				
取扱説明書 OPERATOR'S MANUAL			OM*-72840-* 000-193-294-1* (**)	1
操作要領書(多言語) OPERATOR'S GUIDE (MLG)			MLG-72840-* 000-193-297-1* (*1)	1
操作要領書(和) OPERATOR'S MANUAL (JP)			OSJ-72840-* 000-193-363-1* (*1)	1
装填要領書 INSTALLATION MANUAL			IM*-72840-* 000-193-296-1* (**)	1

コード番号末尾の【**】は、選択品の代表型式/コードを表します。
CODE NUMBER ENDING WITH "**" INDICATES THE CODE NUMBER OF REPRESENTATIVE MATERIAL.
(*1)は、それぞれ仕様選択品を表します。
(*1) INDICATE SPECIFICATION SELECTIVE ITEM.

(略図の寸法は、参考値です。 DIMENSIONS IN DRAWING FOR REFERENCE ONLY.)

C7284-Z01-B

PACKING LIST
FAP-3011-MIJ

64BC-X-9854 -1 1/1
A-4

NAME	UNIT	OUTLINE	DESCRIPTION/CODE No.	Q'TY
操作部 CONTROL UNIT			FAP-3011 000-033-332-00	1
付属品 ACCESSORIES				
付属品 ACCESSORIES			FP64-01601 001-634-950-00	1
工事材料 INSTALLATION MATERIALS				
ケーブル & (フイビシ) CABLE ASSEMBLY			F1-70-0600 000-194-061-10	1
工事材料 INSTALLATION MATERIALS			CP26-02001 001-336-500-00	1
工事材料 INSTALLATION MATERIALS			CP64-03401 001-472-330-00	1
図書 DOCUMENT				
フラッシュマウント型紙 FLUSH MOUNTING TEMPLATE			C72-01602-* 000-193-299-1*	1
取付要領書 INSTALLATION INSTRUCTIONS			C72-01604-* 000-193-301-1*	1

(略図の寸法は、参考値です。 DIMENSIONS IN DRAWING FOR REFERENCE ONLY.)

C7284-Z04-B

PACKING LIST
GO-001

64BC-X-9855 -3 1/1
A-5





NAME	UNIT	OUTLINE	DESCRIPTION/CODE No.	Q'TY
ジェスチャーコントローラ GESTURE CONTROLLER			GO-001 000-033-745-00	1
付属品 ACCESSORIES				
付属品 ACCESSORIES			FP64-01501 001-482-130-00	1
図書 DOCUMENT				
ユーザーガイド USER'S GUIDE			C72-01603-* 000-193-300-1*	1

(略図の寸法は、参考値です。 DIMENSIONS IN DRAWING FOR REFERENCE ONLY.)

C7284-Z05-D

FURUNO

CODE NO.	001-336-500-00	26AL-X-9401 -0
TYPE	CP26-02001	1/1

工事材料表					
INSTALLATION MATERIALS					
番号 NO.	名称 NAME	略図 OUTLINE	型名/規格 DESCRIPTIONS	数量 Q'TY	用途/備考 REMARKS
1	Fマウントパッド F MOUNT SPONGE		26-008-1011-0 CODE NO. 100-394-185-10	1	
2	φ7 丸平座金 FLAT WASHER		M3 SUS304 CODE NO. 000-167-453-10	2	
3	φ7 座金 SPRING WASHER		M3 SUS304 CODE NO. 000-167-404-10	2	
4	蝶ナット WING NUT		M3 SUS304 CODE NO. 000-167-826-10	2	
5	寸切ネジ BOLT		M3X40 SUS304 CODE NO. 000-167-884-10	2	

型式/コード番号が2段の場合、下段より上段に代わる進級用品であり、どちらが入っています。なお、品質は変わりません。





TWO TYPES AND CODES MAY BE LISTED FOR AN ITEM. THE LOWER PRODUCT MAY BE SHIPPED IN PLACE OF THE UPPER PRODUCT. QUALITY IS THE SAME.
(略図の寸法は、参考値です。 DIMENSIONS IN DRAWING FOR REFERENCE ONLY.)

FURUNO ELECTRIC CO., LTD.

C7281-M01-A

FURUNO

CODE NO.	001-472-330-00	64BC-X-9401 -0
TYPE	CP64-03401	1/1

工事材料表					
INSTALLATION MATERIALS					
番号 NO.	名称 NAME	略図 OUTLINE	型名/規格 DESCRIPTIONS	数量 Q'TY	用途/備考 REMARKS
1	マウントベース組立品 MOUNT BASE ASSEMBLY		OP26-29-1 CODE NO. 001-353-185-00	1	
2	スナップピン SNAP PIN		26-008-1024-1 CODE NO. 100-398-311-10	2	
3	+皿付タッピング FLAT HEAD TAPPING SCREW		3X20 SUS XM-7 CODE NO. 000-190-275-10	4	
4	φ7 丸平座金 FLAT WASHER		M3 SUS304 CODE NO. 000-167-453-10	2	

(略図の寸法は、参考値です。 DIMENSIONS IN DRAWING FOR REFERENCE ONLY.)

FURUNO ELECTRIC CO., LTD.

C7284-M01-A

FURUNO

CODE NO.	009-000-880-00	64AY-X-9401 -1
TYPE	CP64-02501	1/1

工事材料表					
INSTALLATION MATERIALS					
番号 NO.	名称 NAME	略図 OUTLINE	型名/規格 DESCRIPTIONS	数量 Q'TY	用途/備考 REMARKS
1	+付タッピングネジ SELF-TAPPING SCREW		4X20 SUS304 4X20 SUS304 193 CODE NO. 000-158-850-10 000-806-887-00	4	

型式/コード番号が2段の場合、下段より上段に代わる進級用品であり、どちらが入っています。なお、品質は変わりません。

TWO TYPES AND CODES MAY BE LISTED FOR AN ITEM. THE LOWER PRODUCT MAY BE SHIPPED IN PLACE OF THE UPPER PRODUCT. QUALITY IS THE SAME.
(略図の寸法は、参考値です。 DIMENSIONS IN DRAWING FOR REFERENCE ONLY.)

FURUNO ELECTRIC CO., LTD.

C7259-M01-B

FURUNO

CODE NO.	001-482-130-00	64BC-X-9501 -0
TYPE	FP64-01501	1/1

付属品表					
ACCESSORIES					
番号 NO.	名称 NAME	略図 OUTLINE	型名/規格 DESCRIPTIONS	数量 Q'TY	用途/備考 REMARKS
1	BATT(ALK)電池 ALKALINE DRY CELL		LR03 (OD) E 2PT CODE NO. 000-194-027-10	1	

(略図の寸法は、参考値です。 DIMENSIONS IN DRAWING FOR REFERENCE ONLY.)

FURUNO ELECTRIC CO., LTD.

C7284-F01-A

FURUNO

CODE NO.	001-485-540-00	G4BC-X-9301-2	1/1
TYPE	SP64-01701	BOX NO.	P

SHIP NO.		SPARE PARTS LIST FOR		U S E			SETS PER VESSEL
		17 17 FAP-3012					
		PROCESSOR UNIT FAP-3012*					
ITEM NO.	NAME OF PART	OUTLINE	DRG. NO. OR TYPE NO.	QUANTITY			REMARKS/CODE NO.
				WORKING PER SET	PER VES	SPARE	
1	E1-X GLASS TUBE FUSE		F0MB-A 125V 2A PBF	1	1	2	000-157-479-10
MFR'S NAME		FURUNO ELECTRIC CO., LTD.		DRG. NO.	C7284-P01-C		1/1

(略図の寸法は、参考値です。 DIMENSIONS IN DRAWING FOR REFERENCE ONLY.)

表1 TABLE 1

寸法区分(mm) DIMENSION	公差(mm) TOLERANCE
0 < L ≤ 50	±1.5
50 < L ≤ 100	±2.5
100 < L ≤ 500	±3

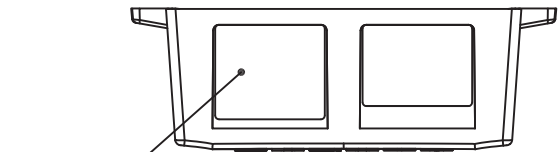

型式銘板
NAMEPLATE

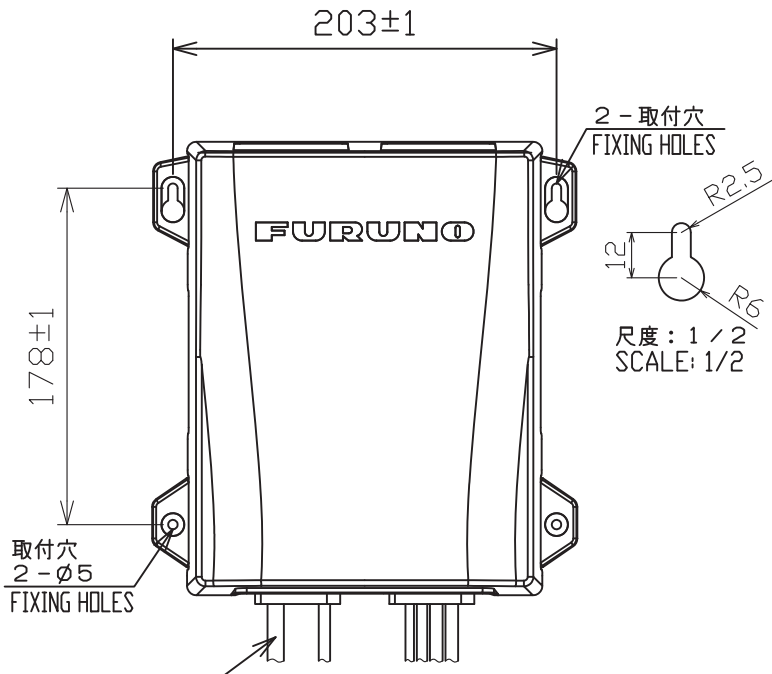

2 - 取付穴
FIXING HOLES

R2.5
12
R6
尺度: 1/2
SCALE: 1/2

取付穴
2-φ5
FIXING HOLES

電源ケーブル
POWER CABLE

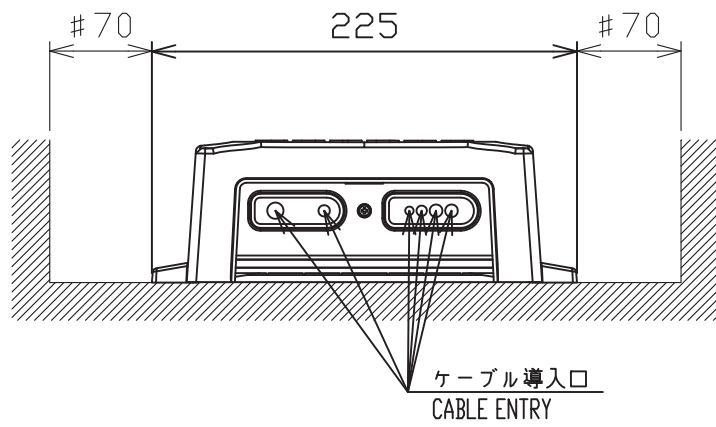
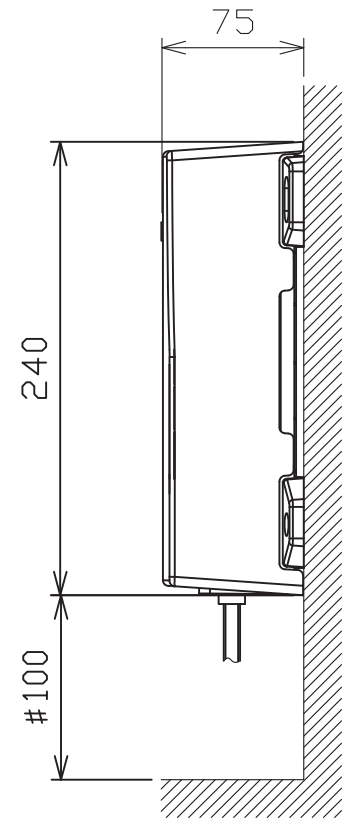

- 注記 1) 指定なき寸法公差は表1による。
 2) #印寸法は最小サービス空間寸法とする。
 3) 取付用ネジはトラスタップピンネジ呼び径4×20を使用のこと。

- NOTE 1. TABLE 1 INDICATES TOLERANCE OF DIMENSIONS WHICH IS NOT SPECIFIED.
 2. #: MINIMUM SERVICE CLEARANCE.
 3. USE TAPPING SCREWS φ4×20 FOR FIXING THE UNIT.

DRAWN 22/May/2017 A. MURAO		TITLE FAP-3012
CHECKED 22/May/2017 T. YAMASAKI		名称 制御部
APPROVED 29/May/2017 H. MAKI		外寸図
SCALE MASS 1.5 ±10% kg	質量はケーブルを含む。 MASS INCLUDES CABLES.	NAME PROCESSOR UNIT
DWGNo. C7284-G04-B	REF.No. 64-034-200G-3	OUTLINE DRAWING

表 1 TABLE 1

寸法区分(mm) DIMENSION	公差(mm) TOLERANCE
0 < L ≤ 50	±1.5
50 < L ≤ 100	±2.5
100 < L ≤ 500	±3

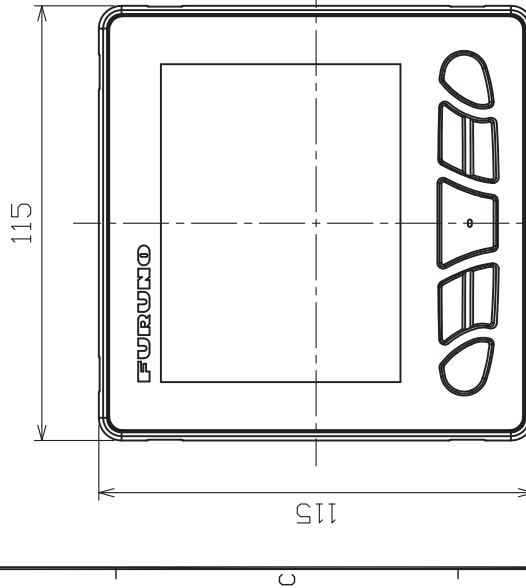
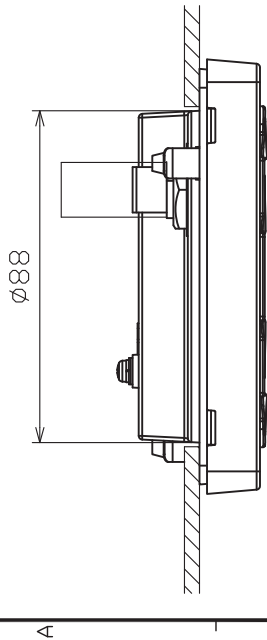
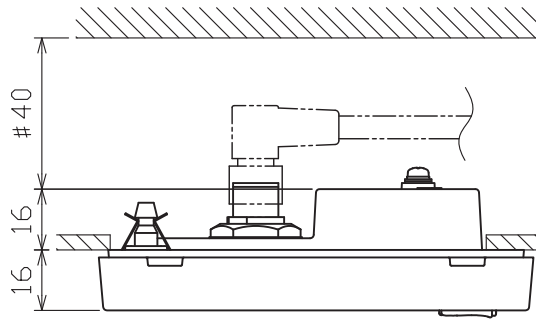
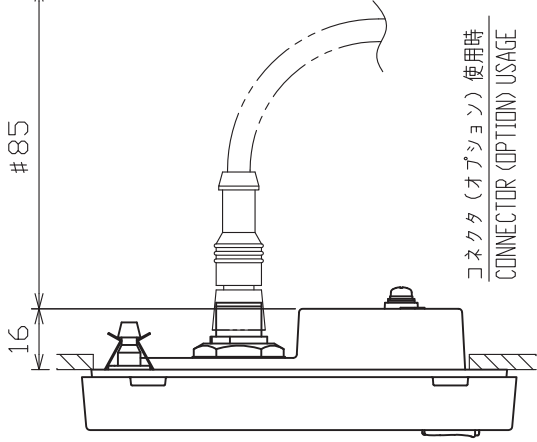
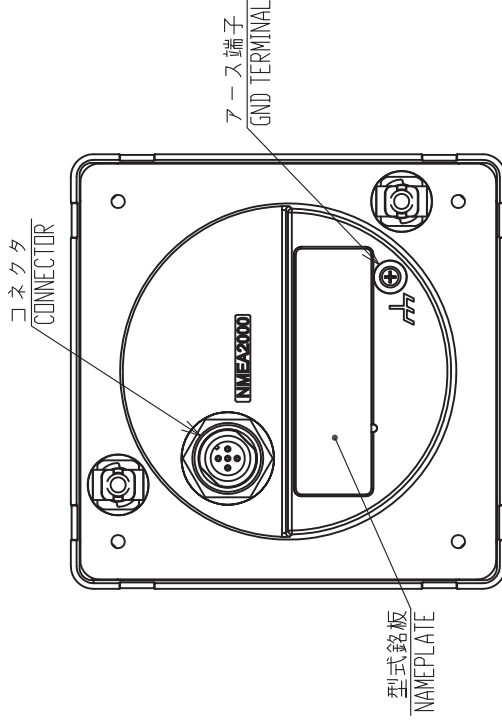
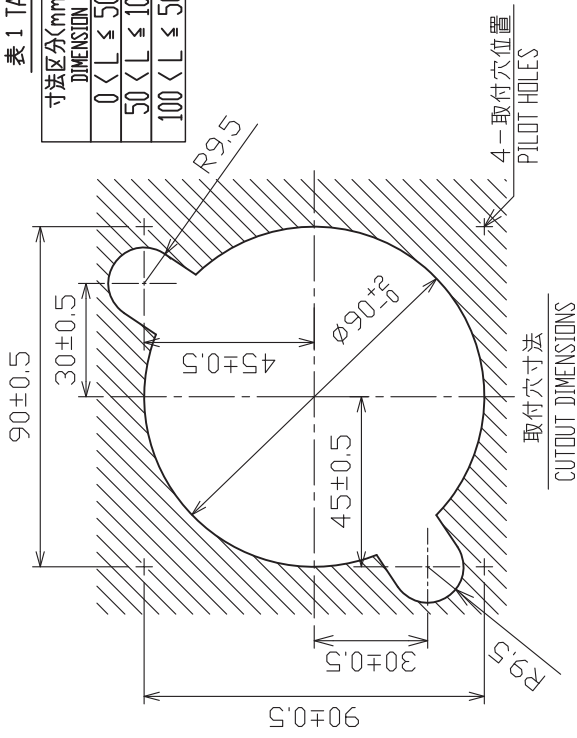

- 注記 1) 指定なき寸法公差は表 1 による。
 2) #印寸法は最小サービスクリアランスとする。
 3) 取付用ネジは+サラツピンネジ呼び径3×20を使用のこと。
- NOTE 1. TABLE 1 INDICATES TOLERANCE OF DIMENSIONS WHICH IS NOT SPECIFIED.
 2. #: MINIMUM SERVICE CLEARANCE.
 3. USE COUNTERSUNK HEAD TAPPING SCREWS φ3×20 FOR FIXING THE UNIT.

DRAWN	22/May/2017 A. MURAD	TITLE	FAP-3011
CHECKED	22/May/2017 T. YAMASAKI	名称	操作部 (前止装備)
APPROVED	29/May/2017 H. MAKI	外寸図	
SCALE	1/100	質量はケーブルを含みません。 MASS DOES NOT INCLUDE CABLE.	
FIG. No.	C7284-G01-B	REF. No.	64-034-102G-4

2 3 4 5



表1 TABLE1

寸法区分(mm) DIMENSION	公差(mm) TOLERANCE
0 < L ≤ 50	±1.5
50 < L ≤ 100	±2.5
100 < L ≤ 500	±3

注記 1) 指定なき寸法公差は表1による。

2) #印寸法は最小サービスクリアランスとする。

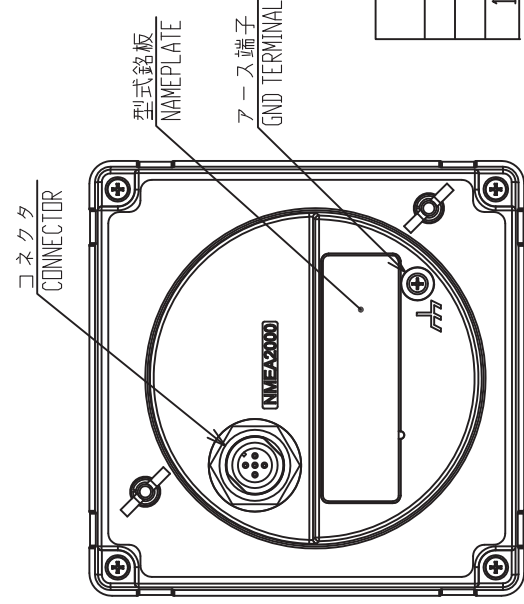
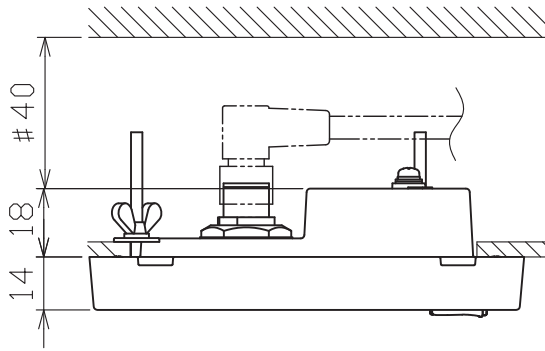
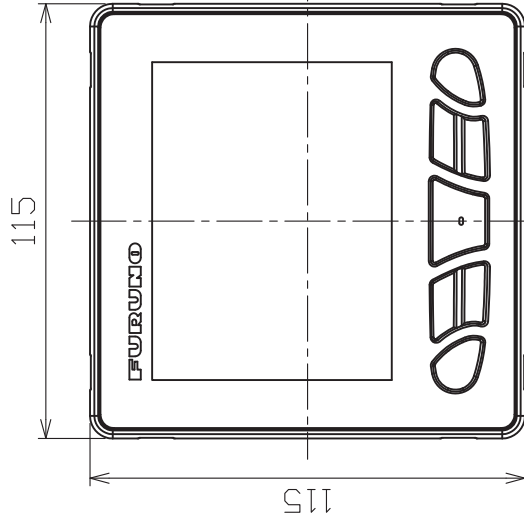
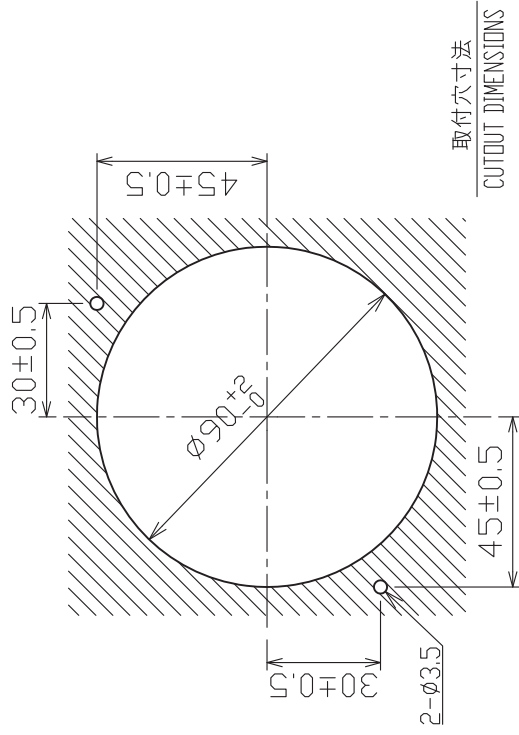
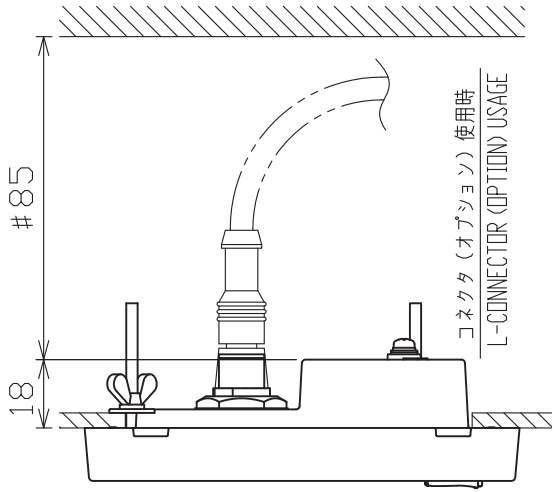
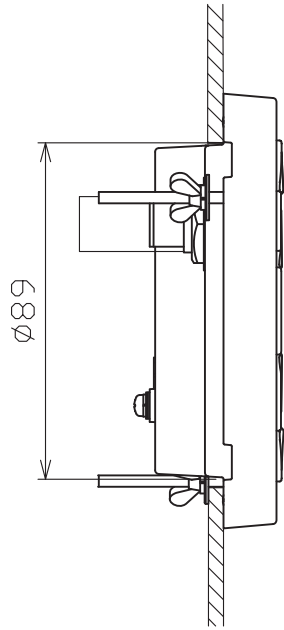
3) 取付用ネジはM3×40寸切りボルト、M3平座金・バネ座金・蝶ナットを使用のこと。

NOTE 1. TABLE 1 INDICATES TOLERANCE OF DIMENSIONS WHICH IS NOT SPECIFIED.

2. # MINIMUM SERVICE CLEARANCE.

3. USE M3x40 STUD BOLT, M3 PLAIN WASHER/SPRING WASHER/WING NUT FOR FIXING THE UNIT.

DRAWN	22/May/2017 A. MURAO	TITLE	FAP-3011
CHECKED	22/May/2017 T. YAMASAKI	名称	操作部 (埋込装備)
APPROVED	29/May/2017 H. MAKI	外寸図	
SCALE	1/100 質量はケーブルを含まず。 MASS DOES NOT INCLUDE CABLE.	仕様	CONTROL UNIT (FLUSH MOUNT)
FIG.No.	C7284-G02-B	図番	OUTLINE DRAWING

2 3 4

55

26

2

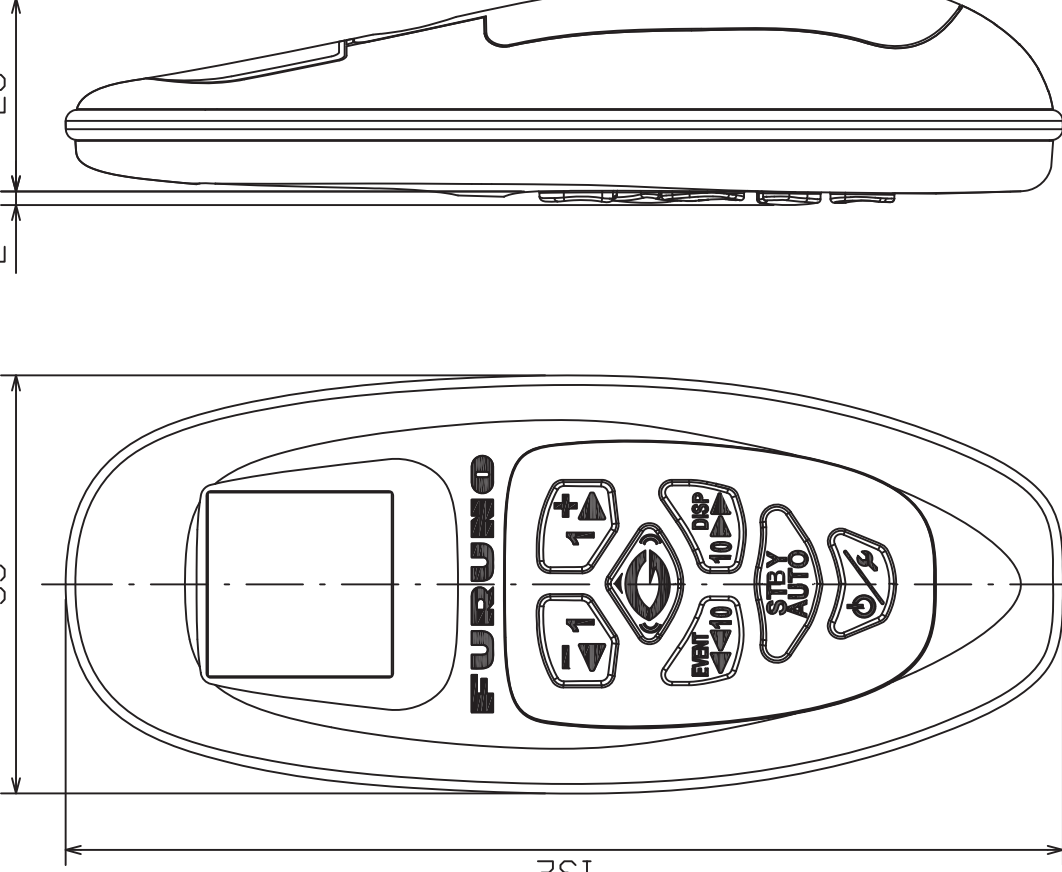

132

表1 TABLE 1

寸法区分(mm)	公差(mm)
DIMENSION	TOLERANCE
0 < L ≤ 50	±1.5
50 < L ≤ 100	±2.5
100 < L ≤ 500	±3

注記

1) 指定なき寸法公差は表1による。

NOTE

1. TABLE 1 INDICATES TOLERANCE OF DIMENSIONS WHICH IS NOT SPECIFIED.

DRAWN	15/Nov/2017 A. MURAD	TITLE	GC-001
CHECKED	15/Nov/2017 T. YAMASAKI	名称	ジェスチャーコントローラ
APPROVED	15/Nov/2017 H. MAKI	外寸図	
SCALE	MASS 0.12 kg 100% 質量は電池を含む。 MASS INCLUDES BATTERY.	NAME	GESTURE CONTROLLER
DWG.No.	C7284-G05-B	REF.No.	64-034-301G-1

OUTLINE DRAWING

表 1 TABLE 1

寸法区分 (mm) DIMENSIONS	公差 (mm) TOLERANCE
$L \leq 50$	± 1.5
$50 < L \leq 100$	± 2.5
$100 < L \leq 500$	± 3
$500 < L \leq 1000$	± 4

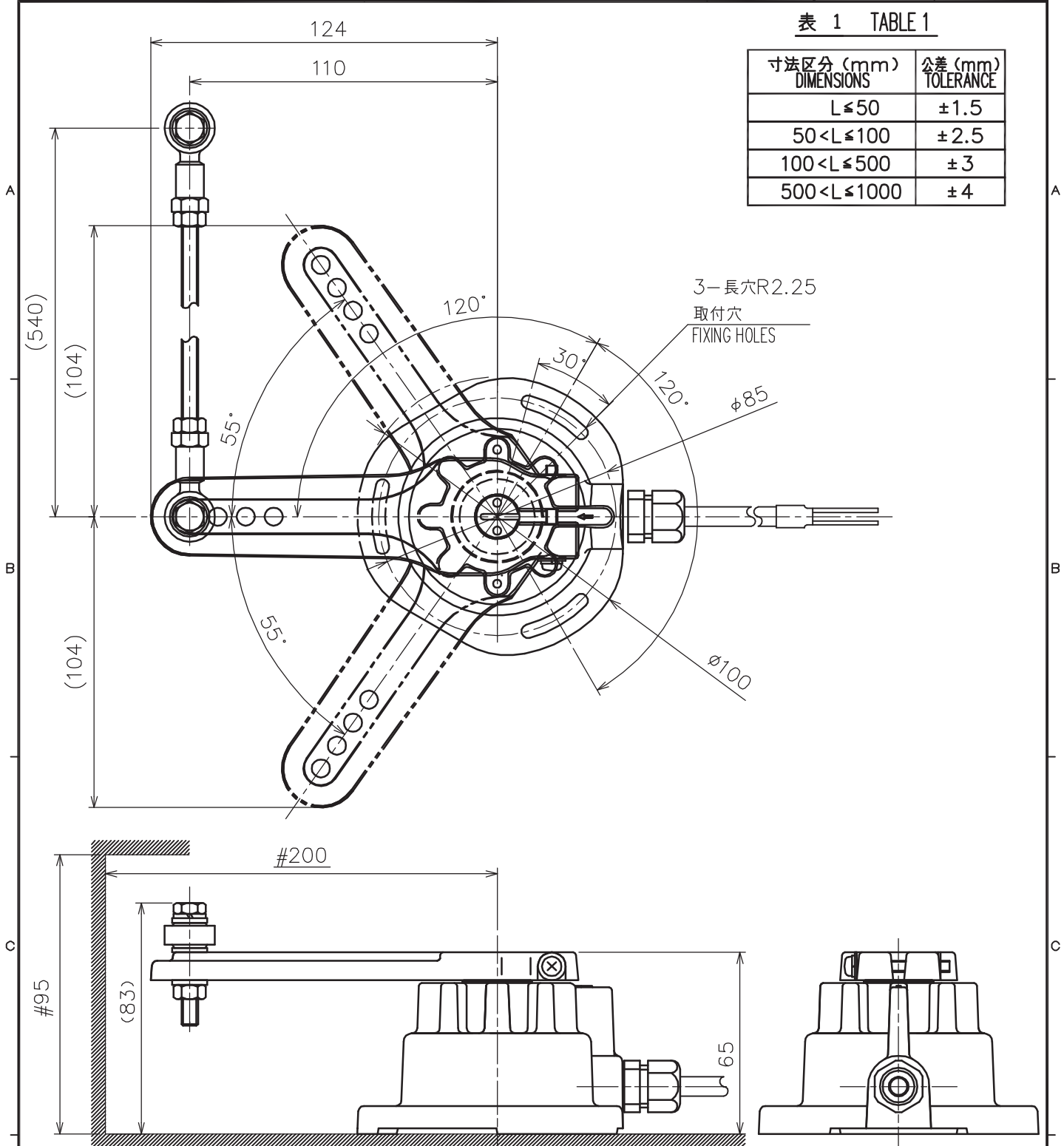

- 注 記 1) #印寸法は最小サービス空間寸法とする。
 2) 指定外の寸法公差は表 1 による。
 3) 取付用ネジは+トフスタッピンネジ呼び径 4×20 を使用のこと。

- NOTE 1. #: MINIMUM SERVICE CLEARANCE.
 2. TABLE 1 INDICATES TOLERANCE OF DIMENSIONS WHICH IS NOT SPECIFIED.
 3. USE SELF-TAPPING SCREWS 4x20 FOR FIXING THE UNIT.

DRAWN Jan. 19, '06	E. MIYOSHI	TITLE FAP-6112
CHECKED	TAKAHASHI. T	名称 追従発信器
APPROVED	Y. Hatai	外寸図
SCALE	MASS $0.46 \pm 10\%$ kg 質量にはケーブルおよび工事材料を含まない。 MASS DOES NOT INCLUDE CABLE AND INSTALLATION MATERIALS.	NAME RUDDER REFERENCE UNIT
DWG.No.	C7250-G07-A	REF.No. 64-024-460G-0
		OUTLINE DRAWING

表1 TABLE 1

寸法区分 (mm) DIMENSIONS	公差 (mm) TOLERANCE
L ≤ 50	±1.5
50 < L ≤ 100	±2.5
100 < L ≤ 500	±3
500 < L ≤ 1000	±4

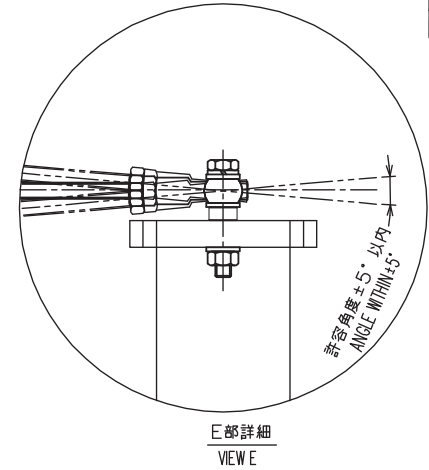
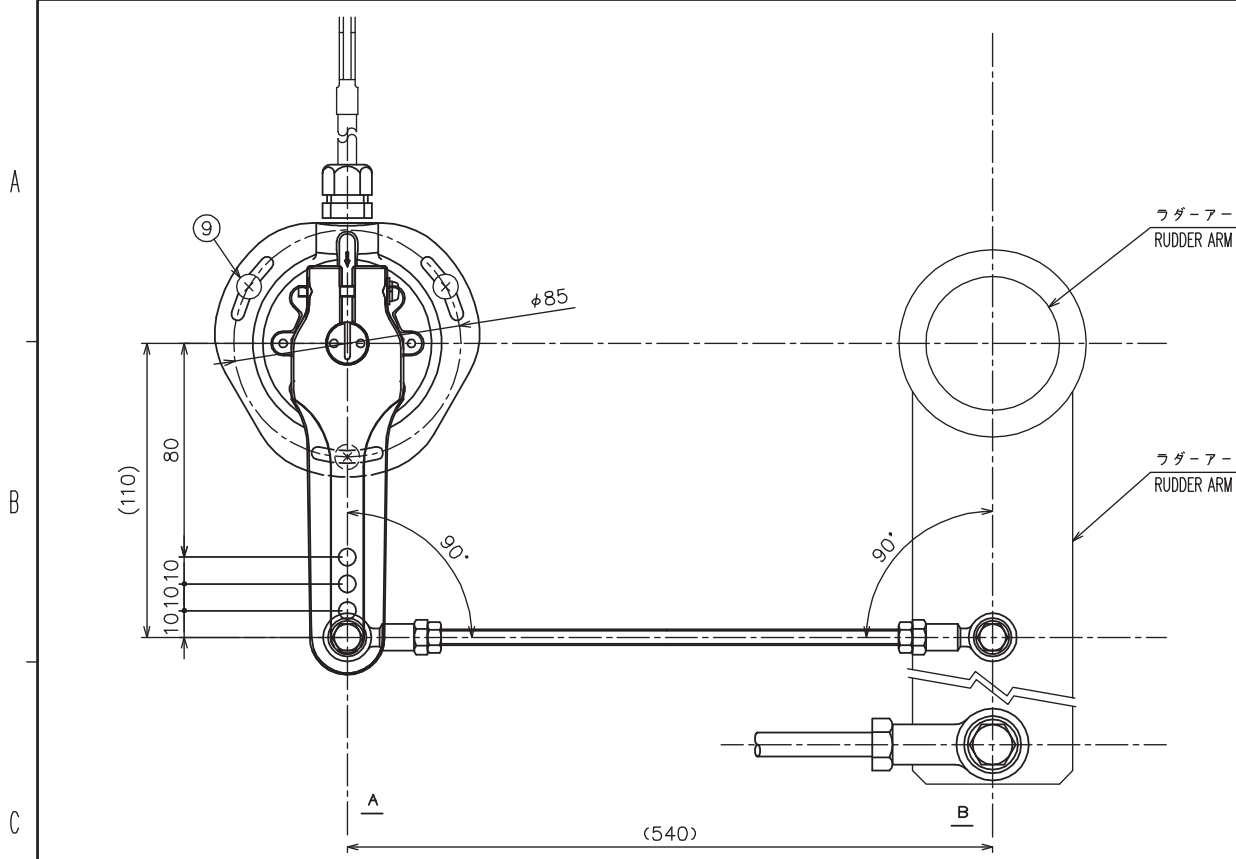

注記 1) A Bの軸線は平行のこと
2) ラダーアーム上面とレンケツボウは平行になるようにFAP-6112本体の高さを調整すること。

NOTE 1. AB AXIS SHOULD BE PARALLEL.
2. ADJUST HEIGHT OF FAP-6112 SO UPPER SURFACE OF RUDDER ARM IS PARALLEL WITH JOINT ROD.

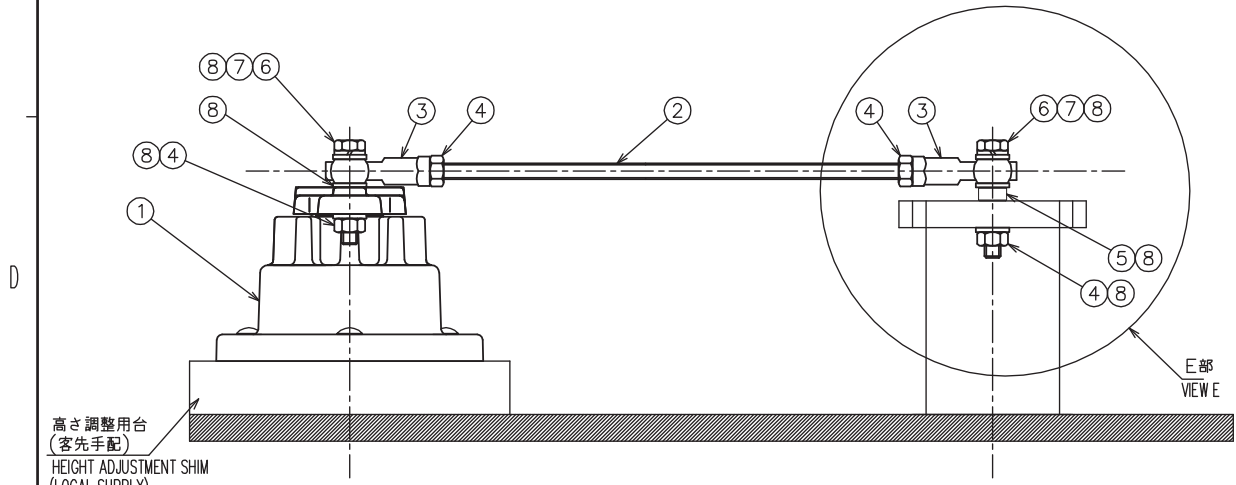

品番 ITEM	品名 NAME	材質 MATERIAL	数量 QTY	図番 DWG.NO.	摘要 REMARKS
9	トラスタップネジ SELF-TAPPING SCREWS	SUS304	3		4x20 (工事材料) 4x20 (INSTALLATION MATERIALS)
8	平座金 FLAT WASHER	SUS304	6		M6 (工事材料) M6 (INSTALLATION MATERIALS)
7	バネ座金 SPRING WASHER	SUS304	2		M6 (工事材料) M6 (INSTALLATION MATERIALS)
6	六角ボルト HEX. BOLT	SUS304	2		M6x40 (工事材料) M6x40 (INSTALLATION MATERIALS)
5	カサアゲスベサ SPACER	SUS304	1	64-024-4612	工事材料 INSTALLATION MATERIALS
4	六角ナット HEX. NUT	SUS304	4		M6 (工事材料) M6 (INSTALLATION MATERIALS)
3	ロッドエンドベアリング ROD END BEARING	SUS303	2	RBT6	工事材料 INSTALLATION MATERIALS
2	連結棒 JOINT ROD	SUS304	1	64-024-4606	工事材料 INSTALLATION MATERIALS
1	追従発信器本体 RUDDER REFERENCE UNIT		1	FAP-6112	

DRAWN Jan. 19, '06	E. MIYOSHI	TITLE	FAP-6112
CHECKED	TAKAHASHI, T	名称	追従発信器
APPROVED	Y. Hatai	NAVJOL-500	装備図
SCALE	MASS 0.46 ±10% kg	質量は工事材料・ケーブルを含まず。 MASS DOES NOT INCLUDE INSTALLATION MATERIALS OR CABLE.	NAME RUDDER REFERENCE UNIT
DWG No.	C7250-Y01-A	REF No.	64-024-461G-0
		INSTALLATION PROCEDURE	



表1 TABLE 1

バックボーンケーブル BACKBONE CABLE	Tコネクタ T-CONNECTOR	終端器 TERMINATOR
M12-05BM+05BF	SS-050505-FMF-TS001	LTWMC-05BMMT-SL8001 MALE (オス) LTWMC-05BFFT-SL8001 FEMALE (メス)
CB-05PM+05BF	NC-050505-FMF-TS001	LTWMN-05AMMT-SL8001 MALE (オス) LTWMN-05AFFT-SL8001 FEMALE (メス)

注記

- *1) 造船所手配。
- *2) オプション。
- *3) コネクタを切り離して接続する。
- *4) ケーブル、Tコネクタ、終端器の関係は表1による。
- *5) 最大3台まで接続可能。
- *6) 既存のCAN bus ネットワークに接続する場合、DC12V入力は不要。

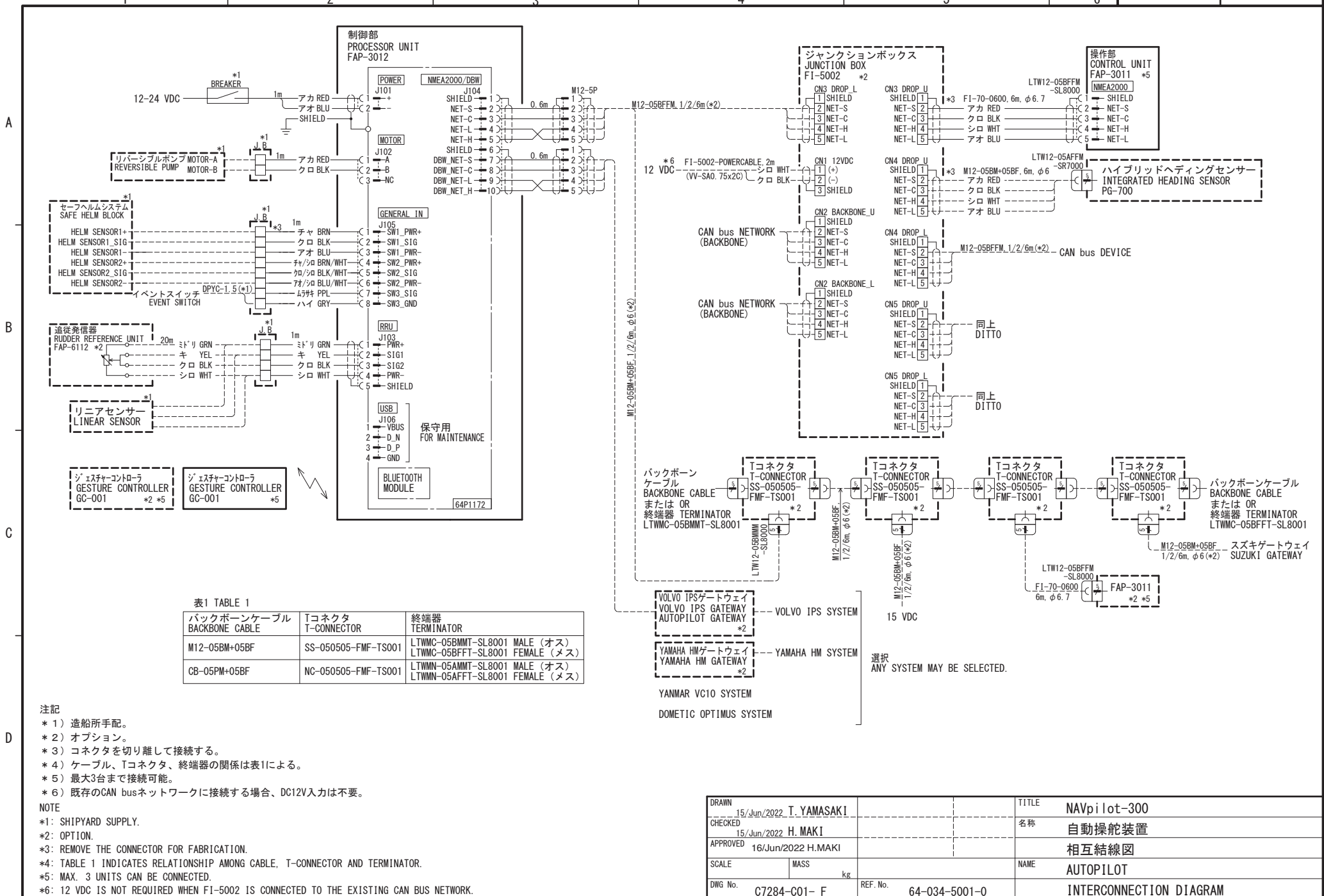
NOTE

- *1: SHIPYARD SUPPLY.
- *2: OPTION.
- *3: REMOVE THE CONNECTOR FOR FABRICATION.
- *4: TABLE 1 INDICATES RELATIONSHIP AMONG CABLE, T-CONNECTOR AND TERMINATOR.
- *5: MAX. 3 UNITS CAN BE CONNECTED.
- *6: 12 VDC IS NOT REQUIRED WHEN FI-5002 IS CONNECTED TO THE EXISTING CAN BUS NETWORK.

DRAWN	15/Jun/2022 T. YAMASAKI	TITLE	NAVpilot-300
CHECKED	15/Jun/2022 H. MAKI	名称	自動操舵装置
APPROVED	16/Jun/2022 H. MAKI		相互結線図
SCALE	MASS	NAME	AUTOPILOT
DWG No.	C7284-C01- F	REF. No.	64-034-5001-0
			INTERCONNECTION DIAGRAM