



NavNet TZtouch BlackBox

Total Control at your fingertips



- Multi touch control user-Interface
- Supports both wide and non-wide resolutions
- BlackBox processor with two video clone outputs
- Wireless connection for Smartphones and Tablets



The World's Most Advanced Multi Touch Navigation Interface

TZtouch brings you pinch-to-zoom capability, as well as other multi touch gestures for the most intuitive navigation experience.

With the NavNet TZtouch TZTBB, the display unit is selectable from virtually any size of wide or non-wide monitor supporting multi touch controls.



Specification for NavNet TZTBB

The standard spec and features are the same as 9" and 14" MFD models.

INTERFACE	
CAN bus	1 Port
LAN	3 Ports (100 BASE-TX)
USB	6 Ports (USB2.0)
Video Output	2 Ports (DVI-D)
Video Input	2 Ports (NTSC/PAL)
Line Out	1 Port
SD Card Slot	2 Slots (SDXC card - supports upto 128GB)
ENVIRONMENT	
Temperature (IEC60945)	-15°C to +55°C
Waterproofing	Processor unit: IP22 Switch box: IP56 (front panel)
POWER	
Power Supply	12-24 VDC

SPECIFICATIONS SUBJECT TO CHANGE WITHOUT NOTICE
All brand and product names are registered trademarks, trademarks or service marks of their respective holders.

Interconnection Diagram

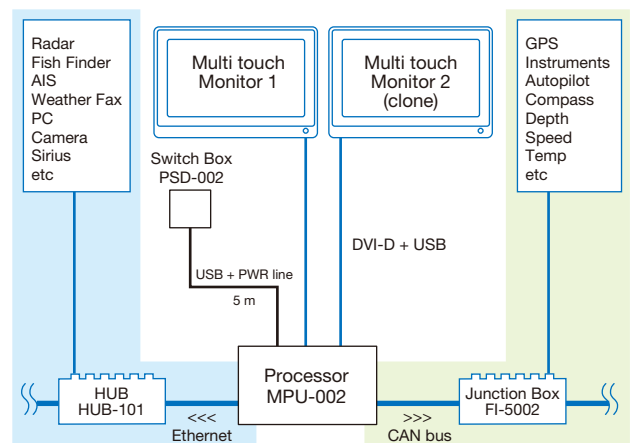

— Standard — Option or Local Supply