

FURUNO

OPERATOR'S MANUAL

CHART RADAR

FAR-3210

FAR-3220

FAR-3220-NXT

FAR-3230S

FAR-3230S-SSD

FAR-3310

FAR-3320

FAR-3320-NXT

FAR-3330S

FAR-3330S-SSD

FAR-3320W

FAR-3330SW

FAR-3210-BB

FAR-3220-BB

FAR-3220-NXT-BB

FAR-3230S-BB

FAR-3230S-SSD-BB

FAR-3220W-BB

Model FAR-3230SW-BB

(Product Name: MARINE RADAR)

ECF

(Elemental Chlorine Free)

The paper used in this manual
is elemental chlorine free.

FURUNO ELECTRIC CO., LTD.

9-52 Ashihara-cho,
Nishinomiya, 662-8580, JAPAN

• FURUNO Authorized Distributor/Dealer

All rights reserved. Printed in Japan

Pub. No. OME-36160-M2

(REFU) FAR-3000series

A : APR. 2014

M2 : OCT. 13, 2020



0 0 0 1 9 7 6 4 1 1 1

IMPORTANT NOTICES

General

- This manual has been authored with simplified grammar, to meet the needs of international users.
- The operator of this equipment must read and follow the instructions in this manual. Wrong operation or maintenance can void the warranty or cause injury.
- Do not copy any part of this manual without written permission from FURUNO.
- If this manual is lost or worn, contact your dealer about replacement.
- The contents of this manual and the equipment specifications can change without notice.
- The example screens (or illustrations) shown in this manual can be different from the screens you see on your display. The screens you see depend on your system configuration and equipment settings.
- Save this manual for future reference.
- Any modification of the equipment (including software) by persons not authorized by FURUNO will void the warranty.
- The following concern acts as our importer in Europe, as defined in DECISION No 768/2008/EC.
 - Name: FURUNO EUROPE B.V.
 - Address: Ridderhaven 19B, 2984 BT Ridderkerk, The Netherlands
- All brand, product names, trademarks, registered trademarks, and service marks belong to their respective holders.
- Windows is a registered trademark of the Microsoft Corporation of the USA and other countries.
- InstantAccess bar is a trademark of FURUNO Electric Co., Ltd.

How to discard this product

Discard this product according to local regulations for the disposal of industrial waste. For disposal in the USA, see the homepage of the Electronics Industries Alliance (<http://www.eiae.org/>) for the correct method of disposal.

How to discard a used battery

Some FURUNO products have a battery(ies). To see if your product has a battery, see the chapter on Maintenance. If a battery is used, tape the + and - terminals of the battery before disposal to prevent fire, heat generation caused by short circuit.

In the European Union

The crossed-out trash can symbol indicates that all types of batteries must not be discarded in standard trash, or at a trash site. Take the used batteries to a battery collection site according to your national legislation and the Batteries Directive 2006/66/EU.

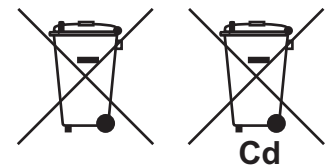

In the USA

The Mobius loop symbol (three chasing arrows) indicates that Ni-Cd and lead-acid rechargeable batteries must be recycled. Take the used batteries to a battery collection site according to local laws.

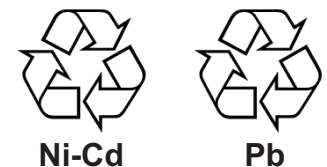

In the other countries

There are no international standards for the battery recycle symbol. The number of symbols can increase when the other countries make their own recycle symbols in the future.



SAFETY INSTRUCTIONS

The operator must read the safety instructions before attempting to operate the equipment.



WARNING

Indicates a potentially hazardous situation which, if not avoided, could result in death or serious injury.



CAUTION

Indicates a potentially hazardous situation which, if not avoided, could result in minor or moderate injury.



Warning, Caution



Prohibitive Action



Mandatory Action



WARNING



Radio Frequency Radiation Hazard

The radar antenna emits electromagnetic radio frequency (RF) energy that can be harmful, particularly to your eyes. Never look directly into the antenna aperture from a close distance while the radar is in operation or expose yourself to the transmitting antenna at a close distance. Distances at which RF radiation level of 100, 50 and 10 W/m² are given in the table below.

Magnetron radar

Radar model	Transceiver	Magnetron	Antenna	100W/m ²	50W/m ²	10W/m ²
FAR-3210/ FAR-3310/ FAR-3210-BB	RTR-105	FNE1201	XN12CF	0.6 m	1.4 m	4.4 m
			XN20CF	0.4 m	0.9 m	3.0 m
			XN24CF	0.3 m	0.6 m	2.5 m
FAR-3220/ FAR-3320/ FAR-3220-BB	RTR-106	MG5436	XN12CF	1.3 m	2.7 m	9.5 m
			XN20CF	1.0 m	1.7 m	6.8 m
			XN24CF	0.7 m	1.3 m	5.5 m
FAR-3320W/ FAR-3220W-BB	RTR-108	MG5436	XN20CF	0.5 m	1.2 m	5.5 m
			XN24CF	0.3 m	0.9 m	4.0 m
FAR-3230S/ FAR-3330S/ FAR-3230S-BB	RTR-107	MG5223F	XN24CF	1.7 m	2.4 m	3.8 m
			XN30CF	1.4 m	2.1 m	3.4 m
			SN36CF	N/A	0.5 m	4.6 m
FAR-3330SW/ FAR-3230SW-BB	RTR-109	MG5223F	SN36CF	N/A	0.26 m	2.3 m

Solid state radar

Radar model	Transceiver	Antenna	100W/m ²	50W/m ²	10W/m ²
FAR-3230S-SSD/ FAR-3330S-SSD/ FAR-3230S-SSD-BB	RTR-111	SN24CF	N/A	N/A	N/A
		SN30CF	N/A	N/A	N/A
		SN36CF	N/A	N/A	1.0 m
FAR-3220-NXT/ FAR-3320-NXT/ FAR-3220-NXT-BB	RTR-123	XN12CF	0.3 m	0.7 m	3.3 m
		XN20CF	0.24 m	0.32 m	1.9 m
		XN24CF	0.19 m	0.29 m	1.6 m

WARNING



Do not open the equipment.

The equipment uses high voltage that can cause electrical shock. Refer any repair work to a qualified technician.



Before turning on the radar, be sure no one is near the antenna.

Prevent the potential risk of being struck by the rotating antenna, which can result in serious injury or death.



If water leaks into the equipment or something is dropped into the equipment, immediately turn off the power at the switchboard.

Fire or electrical shock can result.



If the equipment is giving off smoke or fire, immediately turn off the power at the switchboard.

Fire or electrical shock can result.



If you feel the equipment is acting abnormally or giving off strange noises, immediately turn off the power at the switchboard and contact a FURUNO service technician.



Do not disassemble or modify the equipment.

Fire, electrical shock or serious injury can result.



Make sure no rain or water splash leaks into the equipment.

Fire or electrical shock can result if water leaks into the equipment.



Do not place liquid-filled containers on or near the equipment.

Fire or electrical shock can result if a liquid spills into the equipment.

WARNING



Do not operate the equipment with wet hands.

Electrical shock can result.



Keep objects away from the open-type antenna unit, so as not to impede rotation of the antenna.

Fire, electrical shock or serious injury can result.



Use the proper fuse.

Use of the wrong fuse can cause fire or damage the equipment.



The TT function is a valuable aid to navigation. However, the navigator must check all aids available to avoid collision.

- The TT automatically tracks an automatically or manually acquired radar target and calculates its course and speed, indicating them with a vector. Since the data generated by the TT depends on the selected radar targets, the radar must be optimally tuned for use with the TT, to ensure required targets will not be lost or unnecessary targets, like sea returns and noise, will not be acquired and tracked.
- A target is not always a landmass, reef, ship, but can also be returns from the sea surface and from clutter. As the level of clutter changes with the environment, the operator must correctly adjust the sea and rain clutter controls and the gain control so that the target echoes do not disappear from the radar screen.

CAUTION

The plotting accuracy and response of this TT meets IMO standards. Tracking accuracy is affected by the following:

- Tracking accuracy is affected by course change. One to two minutes is required to restore vectors to full accuracy after an abrupt course change. (The actual amount depends on gyrocompass specifications.)
- The amount of tracking delay is inversely proportional to the relative speed of the target. Delay is approx. 15-30 seconds for the higher relative speed; approx. 30-60 seconds for the lower relative speed. The following factors can affect accuracy:
 - Echo intensity
 - Radar transmission pulse length
 - Radar bearing error
 - Gyrocompass error
 - Course change (own ship and targets)



Handle the LCD carefully.

The LCD is made of glass, which can cause injury if broken.



The data presented by this equipment is intended as a source of navigation information.

The prudent navigator never relies exclusively on any one source of navigation information, for safety of vessel and crew.

Warning Label(s)

Warning label(s) is(are) attached to the equipment. Do not remove the label(s). If a label is missing or damaged, contact a FURUNO agent or dealer about replacement.

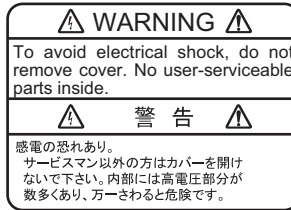

Name: Warning Label 1
Type: 86-003-1011-3
Code No.: 100-236-233-10



Name: Warning Sticker
Type: 03-142-3201-0
Code No.: 100-266-890

TABLE OF CONTENTS

FOREWORD.....	xviii
SYSTEM CONFIGURATIONS.....	xxii
1. OPERATIONAL OVERVIEW.....	1-1
1.1 Radar Control Unit RCU-025.....	1-1
1.1.1 Radar Control Unit RCU-025 description	1-1
1.1.2 Operator fitness.....	1-3
1.2 Trackball Control Unit RCU-026	1-4
1.2.1 Trackball Control Unit RCU-026 description	1-4
1.2.2 Operator fitness.....	1-4
1.3 Processor Unit EC-3000.....	1-5
1.4 How to Turn the System On/Off	1-6
1.5 How to Select a Color Palette.....	1-7
1.6 How to Adjust the Display Brilliance, Control Unit Backlighting.....	1-8
1.6.1 Manual brilliance adjustment.....	1-8
1.6.2 Control unit backlighting	1-9
1.7 Display Modes	1-10
1.7.1 How to select a display mode.....	1-10
1.7.2 Limitations when using the chart radar mode.....	1-10
1.7.3 Limitations when using Back-up ECDIS mode.....	1-10
1.8 Display Screens.....	1-11
1.8.1 Radar display	1-11
1.8.2 Chart radar display	1-13
1.8.3 Chart display	1-14
1.9 Status Bar.....	1-15
1.9.1 Status bar for radar, chart radar mode	1-15
1.9.2 How to operate the buttons, slider bars on the Status bar	1-16
1.10 InstantAccess Bar™	1-17
1.10.1 How to operate the buttons, slider bars on the InstantAccess bar™	1-19
1.11 Sensor Information, Datum Box	1-20
1.12 Menu Overview.....	1-21
1.12.1 Basic menu operation.....	1-21
1.12.2 Menu history feature.....	1-22
1.12.3 How to enter numeric data	1-23
1.12.4 How to enter alphanumeric character data	1-23
1.13 Context-Sensitive Menus in the Radar Mode.....	1-24
1.13.1 Context-sensitive menus available with buttons and boxes	1-24
1.13.2 Context-sensitive menus in the display area in the radar and chart radar modes	1-26
1.14 Cursor Position	1-27
1.15 How to Select Sensor Settings.....	1-27
1.16 How to Enter Ship Speed	1-28
1.17 How to Enter Heading	1-30
1.18 How to Mark MOB Position	1-31
1.19 How to Offset Position.....	1-32
1.20 How to Select Time Format, Set Local Time.....	1-32
1.21 How to Take a Screenshot of the Display	1-33
1.22 The Settings Menu	1-33
1.23 User Profiles for Radar, Chart Radar	1-33
1.23.1 How to create a profile	1-33
1.23.2 How to disable a profile	1-33
1.23.3 How to activate a profile	1-34

TABLE OF CONTENTS

1.23.4	How to restore a profile to the default settings.....	1-34
1.23.5	How to change the settings on the current display to the recommended settings.....	1-34
1.24	How to View Chart Software Version No., Chart System Information, and Operator's Manual.....	1-37
1.25	Tips (operational guidance)	1-38
1.26	Printer Information.....	1-38
2.	RADAR, CHART RADAR OPERATION.....	2-1
2.1	How to Transmit.....	2-1
2.2	How to Tune the Radar Receiver.....	2-1
2.2.1	Tuning for magnetron radar	2-1
2.3	Pulse Length	2-2
2.3.1	How to select a pulse length	2-2
2.3.2	How to change the pulse length.....	2-3
2.4	How to Adjust the Sensitivity.....	2-3
2.5	How to Suppress Sea Clutter.....	2-3
2.5.1	How to reduce sea clutter automatically	2-4
2.5.2	How to reduce sea clutter manually	2-4
2.5.3	How to use the BERTHING STC function.....	2-5
2.6	How to Suppress Rain Clutter.....	2-5
2.6.1	How to reduce rain clutter automatically	2-5
2.6.2	How to reduce rain clutter manually	2-6
2.7	Interference Rejector.....	2-7
2.8	Echo Stretch.....	2-8
2.9	Echo Averaging.....	2-8
2.10	Automatic Clutter Elimination (ACE) Function	2-9
2.10.1	How to turn the Automatic Clutter Elimination (ACE) function on/off	2-9
2.10.2	How to adjust the gain in the Automatic Clutter Elimination (ACE) mode.....	2-9
2.10.3	Automatic Clutter Elimination (ACE) menu	2-9
2.10.4	How to get the high sensitivity.....	2-10
2.10.5	How to suppress the false echoes	2-10
2.11	Noise Rejector.....	2-11
2.12	Wiper.....	2-11
2.13	How to Preset Controls for Specific Navigation Purpose	2-12
2.13.1	How to select a customized echo.....	2-14
2.13.2	How to edit a customized echo	2-15
2.13.3	How to restore a user customized echo to the saved settings.....	2-16
2.13.4	How to restore a user customized echo to the factory default settings.....	2-16
2.14	How to Suppress Second-trace Echoes	2-16
2.15	Presentation Modes	2-17
2.15.1	How to select a presentation mode.....	2-17
2.15.2	Description of presentation modes.....	2-18
2.15.3	How to reset the course-up automatically	2-20
2.15.4	How to scroll the display in true motion mode (B-type only)	2-20
2.16	How to Select the Range Scale	2-20
2.17	How to Measure the Range to a Target.....	2-21
2.17.1	How to measure the range by using a VRM	2-21
2.17.2	How to set VRM attributes	2-22
2.18	How to Measure the Bearing to a Target	2-23
2.18.1	How to measure the bearing	2-23
2.18.2	How to select bearing reference	2-24
2.19	Collision Assessment by Offset EBL.....	2-24
2.19.1	How to assess risk of collision	2-24
2.19.2	Point of reference for origin point of offset EBL	2-25
2.20	How to Measure the Range and Bearing Between Two Targets	2-26

2.21	How to Off-center the Display.....	2-27
2.22	Target Trails	2-28
2.22.1	Target trails-related indications	2-28
2.22.2	True or relative target trails	2-28
2.22.3	Trail time.....	2-29
2.22.4	How to reset target trails	2-29
2.22.5	How to temporarily remove all target trails from the display.....	2-29
2.22.6	Trail stabilization in true motion.....	2-29
2.22.7	Target trail attributes on the TRAIL menu	2-30
2.23	Parallel Index (PI) Lines	2-31
2.23.1	How to display, erase a PI line	2-31
2.23.2	How to enable/disable PI lines	2-31
2.23.3	How to adjust PI line orientation, PI line interval	2-32
2.23.4	How to select the number of PI lines to display.....	2-32
2.23.5	How to select the bearing reference for the PI line	2-32
2.23.6	How to select the PI lines orientation	2-33
2.23.7	How to reset PI lines	2-33
2.23.8	How to adjust PI line length.....	2-34
2.24	Zoom	2-35
2.25	Markers.....	2-36
2.25.1	Heading line	2-36
2.25.2	Stern marker.....	2-36
2.25.3	North marker	2-36
2.25.4	Own ship marker	2-36
2.25.5	Vectors	2-37
2.25.6	Barge marker.....	2-37
2.25.7	Antenna marker.....	2-38
2.25.8	Cursor.....	2-38
2.25.9	Curved EBL.....	2-39
2.25.10	Display predictor.....	2-39
2.26	How to Adjust Brilliance of Screen Data.....	2-40
2.27	Watch Alert.....	2-41
2.28	Information Box	2-42
2.28.1	Information box contents	2-42
2.28.2	How to show the information box	2-44
2.28.3	How to turn NAV data on/off.....	2-44
2.28.4	How to output data to the wave analysis software (option)	2-46
2.29	Interswitch	2-47
2.29.1	Displaying antenna information	2-47
2.29.2	How to preset antenna and display combinations.....	2-48
2.29.3	How to select an antenna.....	2-50
2.29.4	How to revert to own antenna	2-50
2.30	Dual Radar	2-50
2.30.1	How to enable or disable the dual radar display	2-51
2.30.2	Operating considerations for the dual radar display.....	2-51
2.31	Performance Monitor	2-53
2.32	Magnetron Reset (For A- and B-types)	2-55
2.33	CCRP (Common Consistent Reference Point).....	2-56
2.34	Drop Mark.....	2-58
2.34.1	How to show, hide the drop mark box	2-58
2.34.2	How to inscribe a drop mark.....	2-58
2.34.3	Drop mark bearing reference	2-58
2.34.4	How to erase a drop mark	2-59
2.35	Anchor Watch.....	2-59
2.36	SART	2-60
2.36.1	What is an SART?	2-60

TABLE OF CONTENTS

2.36.2	How to receive an SART	2-60
2.37	Doppler Feature (X-band Solid State Radars only).....	2-61
2.38	Alert Box, Alert List.....	2-62
2.38.1	Alert box	2-62
2.38.2	Alert list	2-62
2.39	Echo Area	2-63
2.40	Echo Color	2-63
2.41	Icing Prevention	2-63
2.42	Shuttle Ferry.....	2-64
2.43	Chart Radar Functions	2-65
2.43.1	How to switch between radar and chart radar modes.....	2-65
2.43.2	How to show or hide chart objects	2-65
2.43.3	How to create and recall custom sets of chart display objects.....	2-67
2.43.4	Chart database information.....	2-68
2.43.5	How to set value for shallow contour, safety depth, safety contour and deep contour	2-68
2.43.6	How to select the chart color and tone.....	2-69
2.43.7	Chart scale indications.....	2-69
2.43.8	Chart status.....	2-69
2.43.9	Chart alert function.....	2-69
2.43.10	Notes details	2-70
2.44	Radar Observation	2-71
2.44.1	General	2-71
2.44.2	False echoes.....	2-72
2.44.3	RACON	2-74
2.44.4	Radar Target Enhancer (RTE).....	2-74
2.44.5	Solid state radar	2-75
3.	TARGET TRACKING (TT)	3-1
3.1	About TT	3-1
3.2	How to Show, Hide the TT Display	3-1
3.3	How to Input Your Ship's Speed	3-2
3.3.1	Echo-referenced speed input.....	3-2
3.4	Automatic Acquisition.....	3-3
3.4.1	How to enable auto acquisition	3-3
3.4.2	How to set an automatic acquisition zone.....	3-4
3.5	Manual Acquisition	3-5
3.5.1	How to set manual acquisition conditions	3-5
3.5.2	How to manually acquire a target.....	3-6
3.6	How to Stop Tracking Targets (including reference targets).....	3-7
3.6.1	How to cancel tracking on individual tracked targets	3-7
3.6.2	How to cancel tracking on all TTs	3-7
3.7	TT Symbols and TT Symbol Attributes	3-7
3.7.1	TT symbols.....	3-7
3.7.2	TT symbol brilliance	3-8
3.7.3	Color for TT symbol.....	3-9
3.8	How to Display TT Data	3-10
3.8.1	How to display target data for individual TT	3-10
3.8.2	TT pop-up information.....	3-11
3.8.3	Target list	3-12
3.9	Vector Modes	3-13
3.9.1	Description of vectors.....	3-13
3.9.2	Vector motion and length	3-15
3.10	Past Position Display	3-15
3.10.1	How to enable/disable the past position display, select past position reference.....	3-16

3.10.2	Past position points	3-16
3.11	How to Enter Set and Drift.....	3-16
3.12	TT CPA/TCPA Alarm.....	3-17
3.12.1	How to set the CPA and TCPA limits	3-17
3.12.2	How to enable, disable the TT CPA/TCPA alarm.....	3-17
3.12.3	How to acknowledge the TT CPA/TCPA alarm.....	3-17
3.13	TT Lost Target Alert.....	3-19
3.13.1	How to enable, disable the TT lost target alert.....	3-19
3.13.2	How to set the TT lost target filter	3-19
3.14	Trial Maneuver.....	3-20
3.14.1	Types of trial maneuvers	3-20
3.14.2	How to do a trial maneuver	3-21
3.14.3	How to terminate a trial maneuver	3-24
3.15	TT Simulation Mode	3-25
3.16	TT Alerts	3-26
3.17	How to Set a Target Name (B-types only).....	3-26
3.17.1	How to enable the target name feature	3-26
3.17.2	How to set up preset names.....	3-27
3.17.3	How to assign a name to a target.....	3-28
3.18	Criteria for Selecting Targets for Tracking.....	3-29
3.19	Factors Affecting Target Tracking	3-30
4.	AIS OPERATION	4-1
4.1	How to Deactivate the AIS Function.....	4-2
4.2	How to Show, Hide the AIS Display	4-3
4.3	AIS Symbols	4-3
4.4	How to Filter AIS Targets	4-6
4.5	How to Activate Targets	4-6
4.5.1	How to activate specific target.....	4-6
4.5.2	How to automatically activate targets.....	4-7
4.6	How to Sleep Targets	4-7
4.6.1	How to sleep an activated AIS target	4-7
4.6.2	How to sleep all activated AIS targets.....	4-8
4.7	How to Display AIS Target Data.....	4-8
4.7.1	AIS pop-up information.....	4-8
4.7.2	Basic AIS target data.....	4-8
4.7.3	Expanded AIS data	4-10
4.8	AIS CPA/TCPA Alarm	4-11
4.9	AIS Symbol Brilliance	4-11
4.10	AIS Symbol Color	4-12
4.11	AIS Lost Targets.....	4-12
4.11.1	How to enable, disable the AIS lost target alert	4-12
4.11.2	How to set the AIS lost target filter	4-13
4.12	How to Display AIS Target Past Positions.....	4-13
4.12.1	How to enable/disable the past position display, select past position reference	4-13
4.12.2	Past position points	4-14
4.13	How to Display True or Relative Speed Vectors	4-14
4.14	Association of TT and AIS Targets.....	4-14
4.14.1	How to select association method.....	4-14
4.14.2	How to set the conditions for association	4-15
4.15	Voyage Data.....	4-15
4.16	AIS Messages	4-16
4.16.1	How to create and transmit a new AIS message	4-17
4.16.2	How to transmit a saved AIS message	4-17
4.16.3	How to display received AIS messages	4-18

TABLE OF CONTENTS

4.17	How to View Own Ship Data	4-19
4.18	Other AIS Features	4-19
5.	RADAR MAP AND TRACK	5-1
5.1	What is a Radar Map?	5-1
5.2	Presentation Modes	5-1
5.3	How to Show, Hide the Radar Map Display	5-1
5.4	How to Enter Radar Map Marks and Lines	5-2
5.5	How to Find Number of Map Points Used	5-3
5.6	How to Select the Radar Map to Display	5-4
5.7	How to Attach a Comment to a Radar Map, Find Comment for a Map	5-4
5.7.1	How to attach a comment to a radar map	5-4
5.7.2	How to find the comment for a map	5-4
5.8	How to Erase Radar Map Marks and Lines	5-5
5.8.1	How to erase individual radar map marks and lines	5-5
5.8.2	How to erase map marks and lines in an area	5-5
5.8.3	How to erase all radar map marks and lines in a map file	5-6
5.9	How to Copy Radar Map Marks and Lines	5-7
5.9.1	How to copy individual radar map mark and line to another map file	5-7
5.9.2	How to copy radar map marks and lines within an area to another map file ..	5-7
5.9.3	How to copy all radar map marks and lines in a map file to another map file	5-8
5.10	How to Export Radar Map	5-9
5.11	How to Import Radar Map	5-10
5.12	How to Show, Hide Radar Map Features	5-13
5.13	Track	5-13
5.13.1	How to set up ship's track	5-13
5.13.2	How to erase track	5-14
5.14	Route Display	5-14
5.15	User Chart Display	5-15
6.	CHART OVERVIEW	6-1
6.1	Chart Screen Overview	6-1
6.1.1	Electronic chart area	6-2
6.1.2	Status bar	6-4
6.1.3	InstantAccess bar™	6-6
6.1.4	Sensor information box	6-9
6.1.5	Own ship functions box	6-10
6.1.6	Route information box	6-11
6.1.7	Overlay/NAV Tools box	6-12
6.1.8	Alert box	6-12
6.1.9	Permanent warning box	6-12
6.1.10	EBL, VRM boxes	6-12
6.1.11	North mark	6-13
6.1.12	Context-sensitive menus	6-13
6.1.13	How to enter alphanumeric data	6-14
6.2	How to Select a Display Mode	6-15
6.3	How to Select the Chart Operating Mode	6-16
6.4	How to Select the Chart Scale	6-16
6.5	How to Select the Presentation Mode	6-17
6.6	Cursor Position Box	6-18
6.7	The Silent Mode	6-18
6.8	True Motion Reset	6-19
6.9	How to Control Route and User Charts in Voyage Navigation and Voyage Planning Modes	6-20
6.10	How to Use the VRM and EBL	6-21
6.10.1	How to hide/show an EBL, VRM	6-21

6.10.2	How to measure the range and bearing	6-21
6.10.3	How to select bearing reference	6-21
6.10.4	EBL, VRM functions available with the context-sensitive menu	6-22
6.10.5	How to select the calculation method for EBL and VRM	6-23
6.11	Split Screen	6-24
6.11.1	How to activate, deactivate the split screen	6-24
6.11.2	Function availability	6-24
6.11.3	Split screen usage characteristics	6-25
6.12	Datum	6-25
6.12.1	General	6-25
6.12.2	Paper charts	6-25
6.12.3	Electronic sea charts	6-25
6.12.4	Positioning devices and datum	6-25
6.12.5	Chart radar and datum	6-26
6.13	How to Select Sensor Settings	6-26
6.14	How to Enter Ship Speed	6-27
6.15	How to Enter Heading	6-29
6.16	Set up Before Departure	6-30
6.16.1	Updates before departure	6-30
6.16.2	Create or update a route	6-31
6.16.3	How to check and prepare the route, user chart to monitor	6-32
6.16.4	Check configuration of navigation sensors	6-35
6.16.5	How to reset odometer and trip meter	6-36
7.	HOW TO MANAGE CHARTS	7-1
7.1	How to Install Public Keys for ENC Charts	7-1
7.2	How to Install ENC Licenses, Charts	7-2
7.2.1	How to install an ENC license	7-2
7.2.2	How to install ENC charts	7-3
7.3	How to Delete ENC Licenses	7-5
7.4	How to Update ENC Chart Manufacturer Info	7-6
7.5	How to Install C-MAP Charts	7-7
7.5.1	How to register the eToken	7-7
7.5.2	How to install the C-MAP database	7-7
7.5.3	How to install C-MAP licenses	7-9
7.5.4	How to generate and order an update file	7-10
7.5.5	How to apply the update file	7-10
7.5.6	How to check license status	7-11
7.6	How to Delete a C-MAP Database	7-11
7.7	How to Export a List of Charts	7-11
7.8	How to Export a List of Specific Licenses	7-11
7.9	How to Show the ENC Permit	7-12
7.10	How to Backup, Restore Licenses	7-12
7.11	How to View Permit Expiration Date	7-13
7.12	How to Display Install/Update History	7-14
7.13	Catalog of Chart Cells	7-15
7.13.1	How to group chart cells	7-17
7.13.2	How to view status of chart cells	7-19
7.14	How to Open Charts	7-19
7.15	How to Print Chart List, Cell Status List	7-20
7.15.1	How to print the chart list	7-20
7.15.2	How to show the cell status list	7-21
7.16	How to Delete Charts	7-22
7.17	How to Show Publishers Notes for ENC Charts	7-22
7.18	How to Find the Chart Type	7-23
7.19	How to Update ENC, C-MAP Charts Manually	7-23

TABLE OF CONTENTS

7.19.1	How to insert update symbols	7-24
7.19.2	How to copy objects from an official chart and insert them	7-25
7.19.3	How to ignore chart objects.....	7-25
7.19.4	How to delete (hide) a chart object	7-26
7.19.5	How to modify existing update symbols	7-26
7.19.6	How to review a chart object.....	7-26
7.19.7	How to remove all manual update data.....	7-27
7.20	How to Synchronize Chart Data.....	7-27
7.20.1	How to select the units to synchronize.....	7-28
7.20.2	How to check synchronization status	7-28
7.20.3	Manual updates and synchronization.....	7-29
7.21	How to Reconvert All SENC Charts	7-30
7.22	How to Manage Gate-1 Charts	7-30
7.22.1	How to select the chart type(s) to install	7-30
7.22.2	How to install charts and licenses	7-31
7.22.3	How to order licenses.....	7-31
7.23	How to Delete Chart Data	7-32
8.	HOW TO CONTROL CHART OBJECTS.....	8-1
8.1	How to Browse Your Charts	8-1
8.2	How to Control Visibility of Chart Objects	8-1
8.2.1	How to set value for shallow contour, safety depth, safety contour and deep contour	8-1
8.2.2	Basic Setting menu	8-3
8.2.3	Chart Display menu.....	8-4
8.2.4	Display base.....	8-5
8.3	How to Control Visibility of Symbols, Features	8-6
8.3.1	General page	8-6
8.3.2	Tracking page	8-7
8.3.3	Route page	8-9
8.3.4	Mariner page.....	8-10
8.3.5	Targets page.....	8-11
8.4	Control of Predefined IMO Chart Display Settings.....	8-12
9.	VECTOR (S57) CHARTS.....	9-1
9.1	Introduction to S57 Charts	9-1
9.1.1	Definitions of terms	9-2
9.1.2	Chart legend for S57 charts	9-2
9.1.3	Permanent warnings for S57 charts.....	9-3
9.2	Chart Viewing Dates and Seasonal Features of the S57 Chart.....	9-4
9.2.1	Introduction	9-4
9.2.2	How to set Display date and Update Review dates	9-4
9.2.3	About chart viewing date dependency of S57 standard.....	9-5
9.2.4	How to approve and highlight S57 chart updates	9-6
9.3	Symbology Used in S57 Charts	9-7
9.3.1	Presentation library used for S57 chart features.....	9-7
9.4	How to Find Information About S57 Chart Objects	9-8
9.5	Admiralty Information Overlay (AIO)	9-9
9.5.1	Installation	9-9
9.5.2	How to display the AIO.....	9-9
9.5.3	Catalog of AIO cells	9-10
9.5.4	How to find AIO chart object information.....	9-10
9.5.5	How to select the information to display.....	9-11
10.	C-MAP CHARTS.....	10-1
10.1	How to Register the System at C-MAP	10-1

10.2	How to Order Charts.....	10-1
10.3	How to Apply for Licenses.....	10-1
10.4	Troubleshooting.....	10-2
10.5	Chart Display.....	10-2
10.5.1	Introduction.....	10-2
10.6	Permanent Warnings.....	10-3
10.7	Notice to Mariners (NM).....	10-4
11.	CHART ALERTS	11-1
11.1	Chart Alerts.....	11-2
11.1.1	How to set safety contour.....	11-2
11.1.2	Chart object related settings.....	11-3
11.2	How to Activate Own Ship Look-ahead Area.....	11-4
11.3	Route Planning.....	11-5
11.3.1	Chart alerts for route planning.....	11-5
12.	ROUTES	12-1
12.1	Route Planning Overview.....	12-1
12.2	Main Menu for Route Planning.....	12-2
12.3	How Route Data is Synced.....	12-2
12.4	How to Create a New Route.....	12-4
12.4.1	How to use the Waypoints page.....	12-6
12.4.2	How to use the User Chart page.....	12-7
12.4.3	How to use the Optimize page.....	12-8
12.4.4	How to use the Alert Parameters page.....	12-8
12.4.5	How to use the Check Results page.....	12-10
12.5	How to Modify an Existing Route.....	12-10
12.5.1	How to change waypoint position.....	12-10
12.5.2	How to change other waypoint data.....	12-11
12.5.3	How to add a new waypoint at the end of a route.....	12-11
12.5.4	How to insert a waypoint.....	12-11
12.5.5	How to delete a waypoint.....	12-11
12.5.6	Geometry check of route.....	12-12
12.6	SAR Operations.....	12-13
12.7	Route Bank.....	12-16
12.8	Route Optimization.....	12-17
12.8.1	Available route optimization strategies.....	12-17
12.8.2	How to optimize a route.....	12-18
12.8.3	How to plan a speed profile.....	12-19
12.9	How to Import Routes.....	12-20
12.9.1	How to import FMD-3x00, FCR-2xx9, FAR-3xx0 route data.....	12-20
12.9.2	How to import FEA-2x07 route data.....	12-20
12.9.3	How to import RTZ, CSV, ASCII format route data.....	12-21
12.10	How to Export Route Data.....	12-22
12.10.1	How to export FAR-3xx0 route data.....	12-22
12.10.2	How to export route data in RTZ, CSV, ASCII format.....	12-22
12.11	How to Delete Routes.....	12-23
12.12	How to Transfer Routes.....	12-24
12.12.1	How to turn route transfer on/off.....	12-24
12.12.2	How to send and receive monitored routes.....	12-25
12.12.3	How to send and receive planned routes.....	12-26
12.13	Reports.....	12-27
13.	USER CHARTS	13-1
13.1	Introduction.....	13-1
13.1.1	Objects of user charts.....	13-1

TABLE OF CONTENTS

13.2	How User Charts are Synced.....	13-2
13.3	How to Create a User Chart.....	13-4
13.4	How to Edit Objects on a User Chart	13-8
13.5	How to Delete Objects from a User Chart.....	13-9
13.6	How to Copy User Chart Objects	13-9
13.7	How to Select the User Chart Objects to Display.....	13-10
13.8	How to Import User Chart Data.....	13-10
13.8.1	How to import user chart data from other units	13-10
13.8.2	How to import a user chart created with ECDIS FEA-2x07.....	13-11
13.8.3	How to import RTZ format user charts	13-12
13.9	How to Export User Chart Data.....	13-12
13.9.1	How to export user chart data created on the FMD-3x00	13-12
13.9.2	How to export RTZ format user chart data.....	13-12
13.10	How to Delete User Charts.....	13-13
13.11	User Chart Reports.....	13-13
13.12	How to Select the User Chart(s) to Use in Route Monitoring	13-17
14.	HOW TO MONITOR ROUTES	14-1
14.1	How to Start Route Monitoring	14-1
14.2	How to Stop Route Monitoring (Manual, Auto).....	14-4
14.3	How to Select What Parts of a Route to Display	14-4
14.4	How to View Waypoint Information	14-5
14.5	How to View User Chart Information Linked Monitoring Route.....	14-6
14.6	How to View User Chart Object Information in Route Monitoring	14-6
14.7	How to Change Monitored Route to Planned Route	14-7
14.8	How to Use Instant Track to Return to or Deviate from Monitored Route.....	14-7
14.8.1	Safe off track mode	14-8
14.8.2	Back to track mode	14-9
14.8.3	Instant track messages	14-10
14.8.4	Instant track details	14-11
14.8.5	How to monitor, stop monitoring an instant track route.....	14-11
14.8.6	How to change a monitored route when following an instant track route (safe off track mode only)	14-12
14.8.7	Button label and unit state.....	14-13
14.9	How to Share Route During Route Monitoring.....	14-13
15.	NAVIGATION TOOLS.....	15-1
15.1	How to Access the NAV Tools in the Overlay/NAV Tools Box.....	15-1
15.2	Radar Overlay	15-2
15.2.1	How to show the radar overlay.....	15-3
15.2.2	Error Between Radar Echo Image and Chart	15-3
15.2.3	Error Sources for Radar Echo Image and TT Mismatch.....	15-4
15.3	Parallel Index (PI) Lines	15-5
15.3.1	How to activate, deactivate PI lines	15-5
15.3.2	PI line bearing reference	15-5
15.3.3	Number of PI lines to display	15-5
15.3.4	PI line mode	15-5
15.3.5	How to adjust PI line orientation, PI line interval.....	15-6
15.3.6	How to reset the PI lines	15-6
15.3.7	How to adjust PI line length.....	15-7
15.4	Look-ahead	15-7
15.5	Ring.....	15-8
15.6	Predictor.....	15-9
15.7	Anchor Watch.....	15-10
15.8	UKC (Under Keel Clearance).....	15-11
15.8.1	UKC overview	15-11

15.8.2	How to set UKC	15-12
15.8.3	UKC window	15-12
15.9	Curved EBL	15-13
15.10	Divider	15-14
15.10.1	How to use the divider	15-14
15.10.2	Usage characteristics, limitations	15-15
15.10.3	How to deactivate and erase the divider	15-15
15.10.4	How to select the calculation method for the divider	15-16
16.	NAVIGATION SENSORS	16-1
16.1	CCRS	16-1
16.2	How to Select Navigation Sensors	16-2
16.2.1	Sensors menu description	16-2
16.3	Source of Position	16-6
16.4	Primary and Secondary Positions of Own Ship	16-7
16.5	Source of Navigation Data	16-8
16.6	Switching of Sensor and Indication	16-10
16.7	Filter Status	16-10
16.8	Position Alignment	16-13
16.8.1	How to align position	16-13
16.8.2	How to cancel position alignment	16-13
16.9	Wind Sensor	16-13
16.10	Depth Sensor	16-15
17.	AIS SAFETY, NAVTEX MESSAGES	17-1
17.1	AIS Safety Messages	17-1
17.1.1	How to send an AIS safety message	17-1
17.1.2	How to display received and sent AIS safety messages	17-2
17.1.3	How to delete received and sent AIS safety messages	17-3
17.2	Navtex Messages	17-3
17.2.1	How to receive Navtex messages	17-4
17.2.2	How to delete received Navtex messages	17-5
18.	TT AND AIS DISPLAYS	18-1
18.1	TT Display	18-1
18.1.1	TT symbols	18-1
18.1.2	TT symbol color and size	18-1
18.1.3	How to display tracked target data	18-2
18.1.4	Past position point attributes	18-3
18.1.5	How to set the TT lost target filter	18-3
18.1.6	TT recording functions	18-3
18.2	AIS Display	18-4
18.2.1	AIS symbols	18-4
18.2.2	Voyage data	18-4
18.2.3	How to filter AIS targets	18-5
18.2.4	How to set conditions for automatic activation of sleeping targets	18-6
18.2.5	How to sleep all activated targets	18-6
18.2.6	How to set the AIS lost target filter	18-7
18.2.7	How to display AIS target data	18-7
18.2.8	How to display own ship data	18-9
18.3	Association	18-9
18.3.1	How to select association method	18-9
18.3.2	How to set the conditions for association	18-10
19.	RECORDING FUNCTIONS	19-1
19.1	How to Record User, Position Events	19-1

TABLE OF CONTENTS

19.1.1	User events	19-1
19.1.2	Position events.....	19-2
19.2	Details Log	19-5
19.3	Voyage Log	19-6
19.3.1	How to set conditions of logging	19-8
19.4	Chart Usage Log	19-8
19.5	Danger Targets Log	19-9
19.5.1	How to filter the danger targets log	19-10
19.6	Route Transfer Log	19-11
20.	ALERTS	20-1
20.1	What is an Alert?	20-1
20.2	Alert Box.....	20-2
20.3	How to Temporarily Silence the Buzzer for an Emergency, Alarm or Warning.....	20-5
20.4	How to Acknowledge an Emergency, Alarm or Warning	20-5
20.5	Alert List	20-7
20.6	Alert Log.....	20-10
20.7	Alert Reception from Connected Sensors	20-11
21.	PARAMETERS.....	21-1
21.1	Ship and Route Parameters	21-1
21.2	Forwarding Distances	21-2
21.3	Cost Parameters	21-3
21.4	Instant Track Parameters.....	21-4
22.	SETTINGS MENU	22-1
22.1	How to Access the Settings Menu	22-1
22.2	File Export	22-2
22.3	File Import	22-3
22.4	File Maintenance	22-4
22.5	Self Test	22-5
22.6	Data Sharing	22-9
22.7	Customize	22-10
22.8	Display Test	22-11
22.9	Keyboard Test.....	22-12
22.10	Screenshots.....	22-14
22.10.1	How to export screenshots.....	22-15
22.10.2	How to delete screenshots.....	22-15
22.10.3	How to print screenshots.....	22-15
22.11	User Default.....	22-16
22.12	CCRP	22-17
23.	COMMON REFERENCE SYSTEM	23-1
23.1	Installation of the System	23-1
23.2	Accuracy of the System	23-1
24.	CONNING (optional specification)/MINI CONNING/SIDE CONNING	24-1
24.1	Conning Display	24-1
24.2	Conning Display Examples	24-3
24.3	Mini Conning Display	24-11
24.4	Side Conning Display (landscape monitor only)	24-12
25.	MAINTENANCE AND TROUBLESHOOTING.....	25-1
25.1	Maintenance.....	25-2
25.2	How to Replace the Fuses	25-3
25.3	Trackball Maintenance	25-4

25.4 How to Clean and Replace the Air Inlet Filter.....	25-5
25.4.1 EC-3000 Processor Unit.....	25-5
25.4.2 RCN-303/304 Console Units	25-6
25.5 Troubleshooting.....	25-7
25.6 Consumable Parts.....	25-9
25.7 Color Differentiation Test for S57 Charts.....	25-10
25.8 Fallback Arrangements.....	25-11
APPENDIX 1 MENU TREE	AP-1
APPENDIX 2 ABBREVIATIONS AND SYMBOLS	AP-9
APPENDIX 3 DATA COLOR AND MEANING.....	AP-22
APPENDIX 4 ALERT LIST.....	AP-23
APPENDIX 5 RADIO REGULATORY INFORMATION	AP-48
SPECIFICATIONS	SP-1
INDEX	IN-1

FOREWORD

Congratulations on your choice of the FURUNO FAR-3xx0 Series Marine Radar. We are confident you will see why the FURUNO name has become synonymous with quality and reliability.

Since 1948, FURUNO Electric Company has enjoyed an enviable reputation for innovative and dependable marine electronics equipment. This dedication to excellence is furthered by our extensive global network of agents and dealers.

This equipment is designed and constructed to meet the rigorous demands of the marine environment. However, no machine can perform its intended function unless installed, operated and maintained properly. Please carefully read and follow the recommended procedures for operation and maintenance.

Features

This radar series meets the requirements of IEC 62388 (Marine navigation and radio-communication equipment and systems - Shipborne radar - Performance requirements, method of testing and required test results) and IMO MSC.192(79), IMO Resolution A.817(19), and IEC 61174. This radar displays radar targets, electronic charts, nav lines, Tracked Target (TT) data, AIS targets and other navigation data on a display.

The main features of this series are

- The FAR-3xx0 series consists of the following models and configurations:

Model	Frequency band	Size of monitor unit*	Output power	Transceiver location
Magnetron radar				
FAR-3210	X-band	19.0"	12 kW	Antenna unit
FAR-3210-BB		Local supply	12 kW	Antenna unit
FAR-3310		23.1"/27"	12 kW	Antenna unit
FAR-3220		19.0"	25 kW	Antenna unit
FAR-3220-BB		Local supply	25 kW	Antenna unit
FAR-3320		23.1"/27"	25 kW	Antenna unit
FAR-3320W		23.1"/27"	25 kW	Transceiver unit
FAR-3220W-BB		Local supply	25 kW	Transceiver unit
FAR-3230S	S-band	19.0"	30 kW	Antenna unit
FAR-3230S-BB		Local supply	30 kW	Antenna unit
FAR-3330S		23.1"/27"	30 kW	Antenna unit
FAR-3330SW		23.1"/27"	30 kW	Transceiver unit
FAR-3230SW-BB		Local supply	30 kW	Transceiver unit
Solid state radar				
FAR-3230S-SSD	S-band	19.0"	250 W	Antenna unit
FAR-3330S-SSD		23.1"/27"	250 W	Antenna unit
FAR-3230S-SSD-BB		Local supply	250 W	Antenna unit
FAR-3220-NXT	X-band	19.0"	600 W	Antenna unit
FAR-3320-NXT		23.1"/27"	600 W	Antenna unit
FAR-3220-NXT-BB		Local supply	600 W	Antenna unit

*: Viewing distance: 1020 mm

- New HMI (Human Machine Interface) gives improved operability.
- Accepts SXGA, UXGA video inputs.
- The following monitors have been approved by the IMO under the following categories:
 - MU-231/MU-270W: CAT 1C and CAT 1HC; effective diameter: 320 mm or higher
 - MU-190: CAT 2C and CAT 2HC; effective diameter 250 mm or higher
- Radar, chart and chart radar modes. (The chart radar mode does not meet the criteria for navigation aid for Japanese flag vessels as defined by Japanese law.)
- Many warning features to support safer and more efficient navigation.
- Grounding warnings, safe depth contours.
- Chart database loaded and updated using CD-ROMs.
- Tracked Target (TT) data and AIS data to aid in collision avoidance.
- AIS messaging.
- Route created in chart mode can be displayed on the radar.
- Route planning and route monitoring facilities in the chart mode.

Signal Processing Functions

This radar has the signal processing functions described in the table below. All signal processing functions are set with the picture preset feature.

Signal processing function	Description	Section
Interference rejector	Suppress interference transmitted by other radars. Interference received simultaneously from many radars can be difficult to reduce.	2.7
Echo stretch	Enlarge target echoes, especially small echoes. Suppress interference, sea clutter and rain clutter before using echo stretch, to prevent the enlargement of unwanted echoes.	2.8
Echo averaging	The radar samples echoes with each scan. Targets that show a large change with each scan are judged as clutter and are reduced to display only echoes from legitimate targets.	2.9
Automatic clutter elimination	Discriminate the clutter from the radar echo then reduce the clutter automatically.	2.10
Noise rejector	Reduce the white noise then improves the on-screen S/N ratio by processing the weighted moving average filter for the received echoes in the range direction. Use this function with caution. Weak target echoes may disappear from the screen or the range resolution may worsen.	2.11

Standards Used in this Manual

- Three types of Control Units are available: Radar Control Unit RCU-025 (radar controls with trackball module), ECDIS Control Unit RCU-024 (alphabet keyboard, controls, trackball module) and Trackball Control Unit RCU-026 (trackball module only). Unless noted otherwise, "Control Unit" refers to the RCU-025.
- The system can be operated with the controls of the Radar Control Unit, ECDIS Control Unit or a trackball module. The descriptions in this manual use the trackball module.
- Unless noted otherwise, "click" means to push the left button on a trackball module.
- The keys and controls of the Radar Control Unit are shown in bold face; for example, the **ENTER** key.
- The buttons on the InstantAccess bar™, Status bar and menu items are shown in brackets; for example, the [TUNE] button.

FOREWORD

- Context-sensitive menus are available with many buttons, and boxes and objects. Right-click an item to display the related context-sensitive menu.
- This radar is available in three types of specifications: IMO, A, or B. This manual provides the descriptions for the B type, of which some functions are not available with the IMO or A type. See the menu tree in Appendix 1 for function availability.
- The display colors mentioned in this manual are those with the color palette setting “Day-Gray”.
- InstantAccess bar™ is a trademark of FURUNO Electric Co., Ltd.

Program Number

Please access the following URL if you need software information:
<http://www.furuno.com/en/merchant/chartradar/#software>

System	Program no.	Version no.	Remarks
Antenna unit			
SPU	0359281	01.xx	For magnetron radar
SPU	0359286	01.xx	For solid state radar
MTR-DRV	0359293	01.xx	
PM	0359296	01.xx	
RF-Converter	0359302	01.xx	For solid state radar
Power supply unit			
PSU-Control	0359299	01.xx	
Processor Unit: EC-3000			
Main	0359266	02.xx	

xx: Minor change

The latest IHO standard can be found at <http://www.iho.int>

Virus Prevention

This equipment is not equipped with a virus checker. This equipment operates in real time; therefore, having a virus checker that periodically checks the equipment for viruses would increase the processing load, which can affect operation. However, you can avoid viruses by following the instructions in this section.

When you update a chart

The PC and medium (USB flash memory, etc.) used to download and store an update for an existing chart or a new chart may be infected with a virus. Check the PC and the medium for viruses with a commercial virus checker - BEFORE you connect them to the ECDIS. Be sure the virus checker contains the latest virus definition files.

Network connection

The ECDIS receives and displays information from various navigation equipment and radar via a LAN. A PC and other equipment connected to a network can carry viruses. To prevent the introduction of a virus to the LAN, DO NOT connect the ECDIS or HUB to an external network, including other shipboard LAN.

Do not install 3rd party programs in the ECDIS

Programs installed via an external network can carry viruses that can cause the ECDIS to malfunction. Do not install any Windows® software.

Open Source Software

This product includes software to be licensed under the GNU General Public License (GPL), GNU Lesser General Public License (LGPL), BSD, Apache, MIT and others. The program(s) is/are free software(s), and you can copy it and/or redistribute it and/or modify it under the terms of the GPL or LGPL as published by the Free Software Foundation. Please access the following URL if you need source codes: https://www.furuno.co.jp/en/contact/cnt_oss_e01.html

This product uses the software module that was developed by the Independent JPEG Group.

Reverse engineering

Reverse engineering (reverse assemble, reverse compiler) of the software of this equipment is prohibited. However, reverse engineering is permitted under the following conditions:

- The library used for the reverse engineering (GNU Library General Public License Version 2, GNU Lesser General Public License Version 2.1, or later editions) is clearly noted.
- The reverse engineered software is used only within the scope outlined under the appropriate license.

CE declaration

With regards to CE declarations, please refer to our website (www.furuno.com), for further information on RoHS conformity declarations.

SYSTEM CONFIGURATIONS

NOTICE

The radar(s) must be interconnected to the following type approved sensors:

- Gyrocompass meeting the requirements of the IMO resolution A.424(XI).
- EPFS meeting the requirements of the IMO resolution MSC.112(73).
- SDME meeting the requirements of IMO resolution MSC.96(72).

The radar may be interconnected via HUB-3000 to other FURUNO processing units having approved LAN ports.

Basic configuration is shown with solid line.

FAR-3210/FAR-3220/FAR-3310/FAR-3320/FAR-3220-NXT/FAR-3320-NXT/ FAR-3210-BB/FAR-3220-BB/FAR-3220-NXT-BB

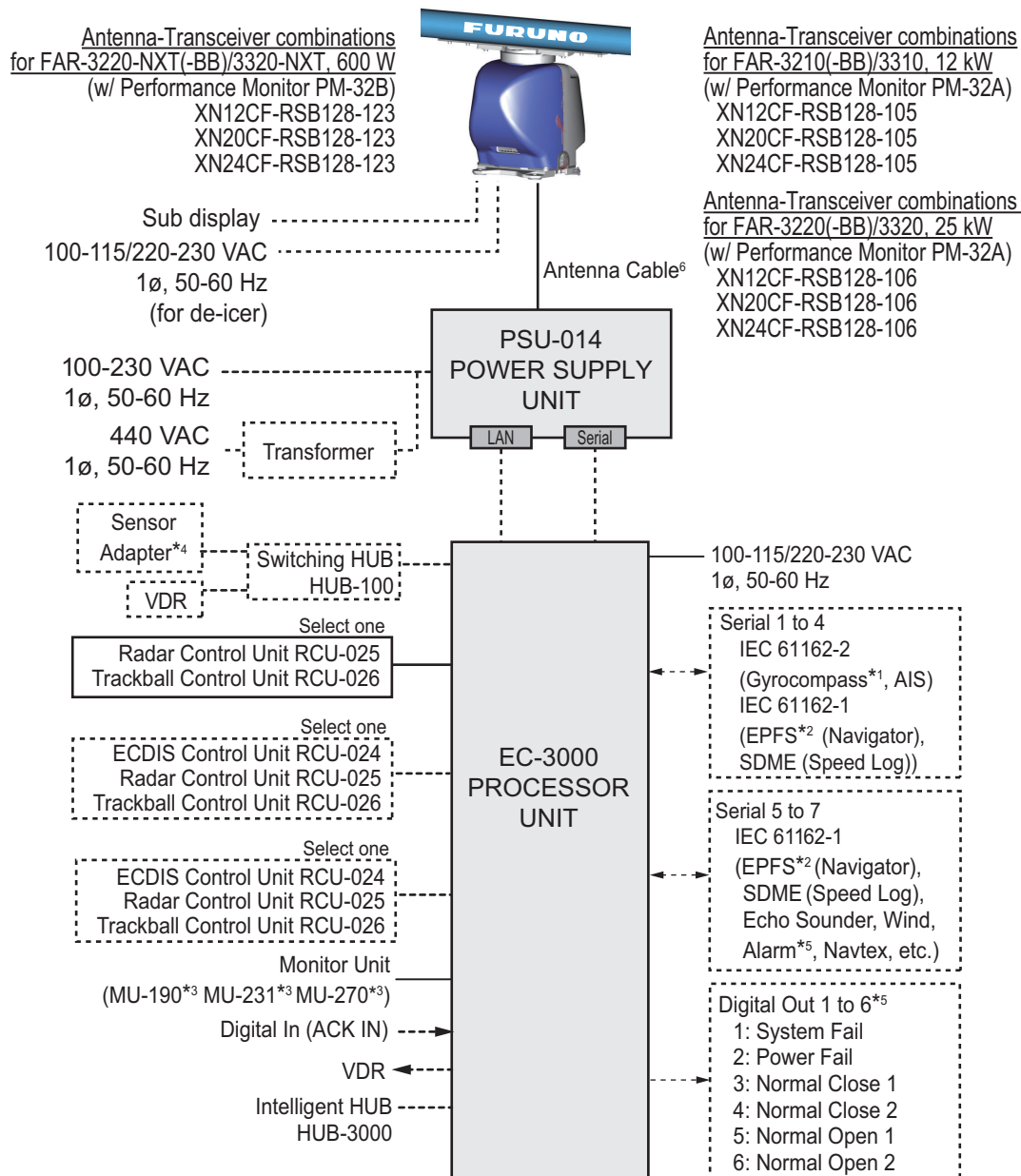

*: See the notes on page xxvi.

FAR-3320W/FAR-3220W-BB

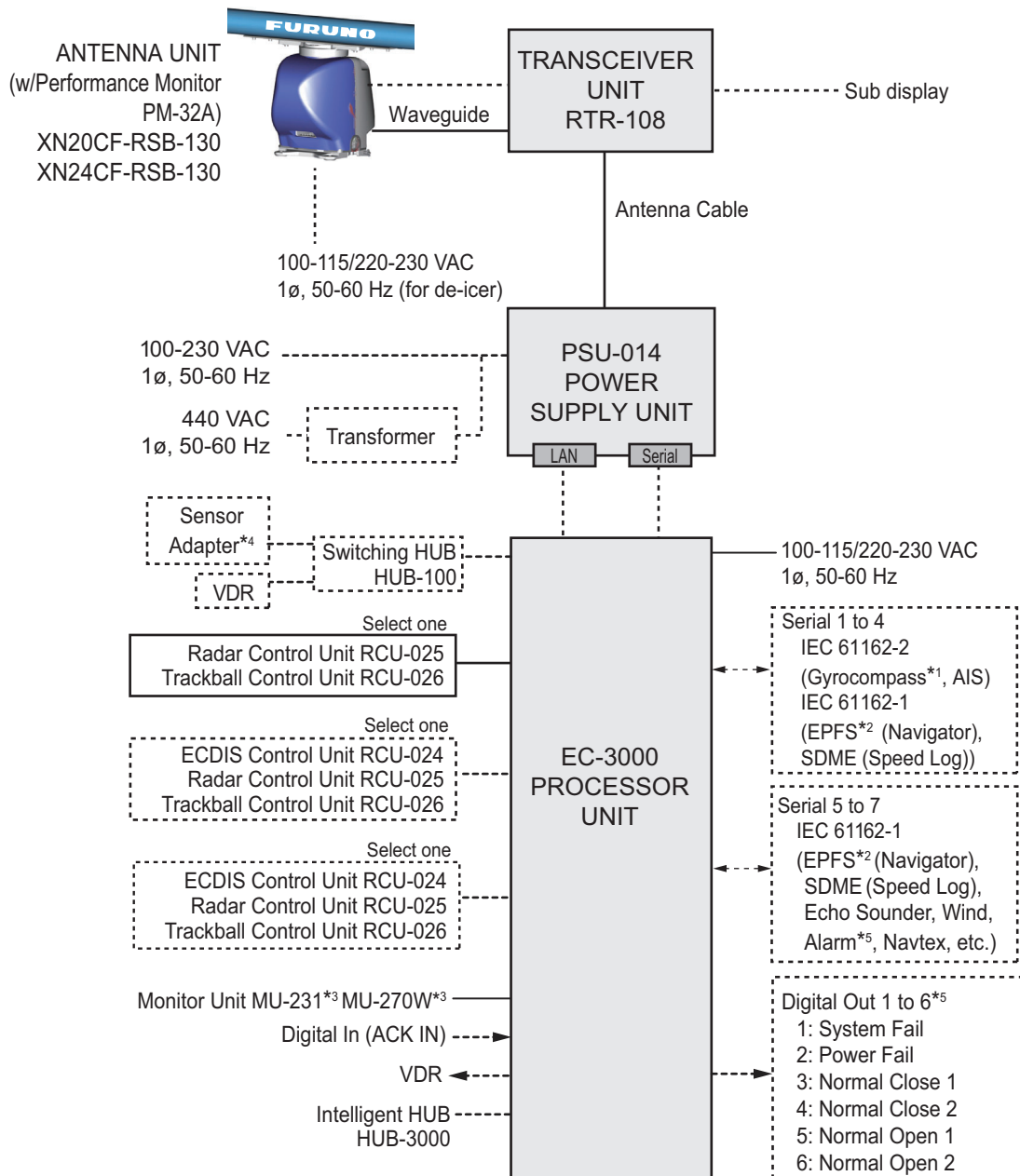

*: See the notes on page xxvi.

FAR-3230S/FAR-3330S/FAR-3230S-BB

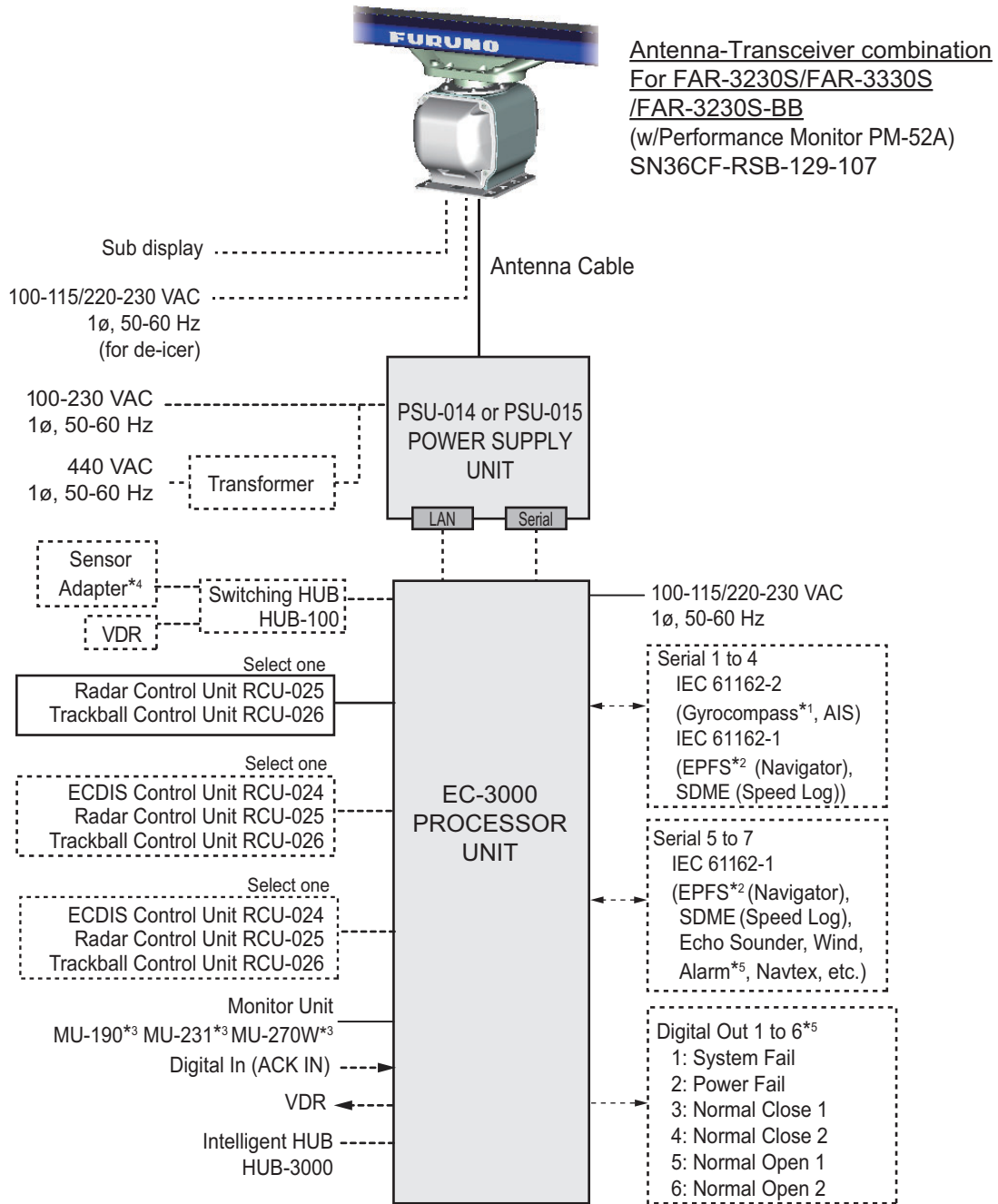

*: See the notes on page xxvi.

FAR-3330SW/FAR-3230SW-BB

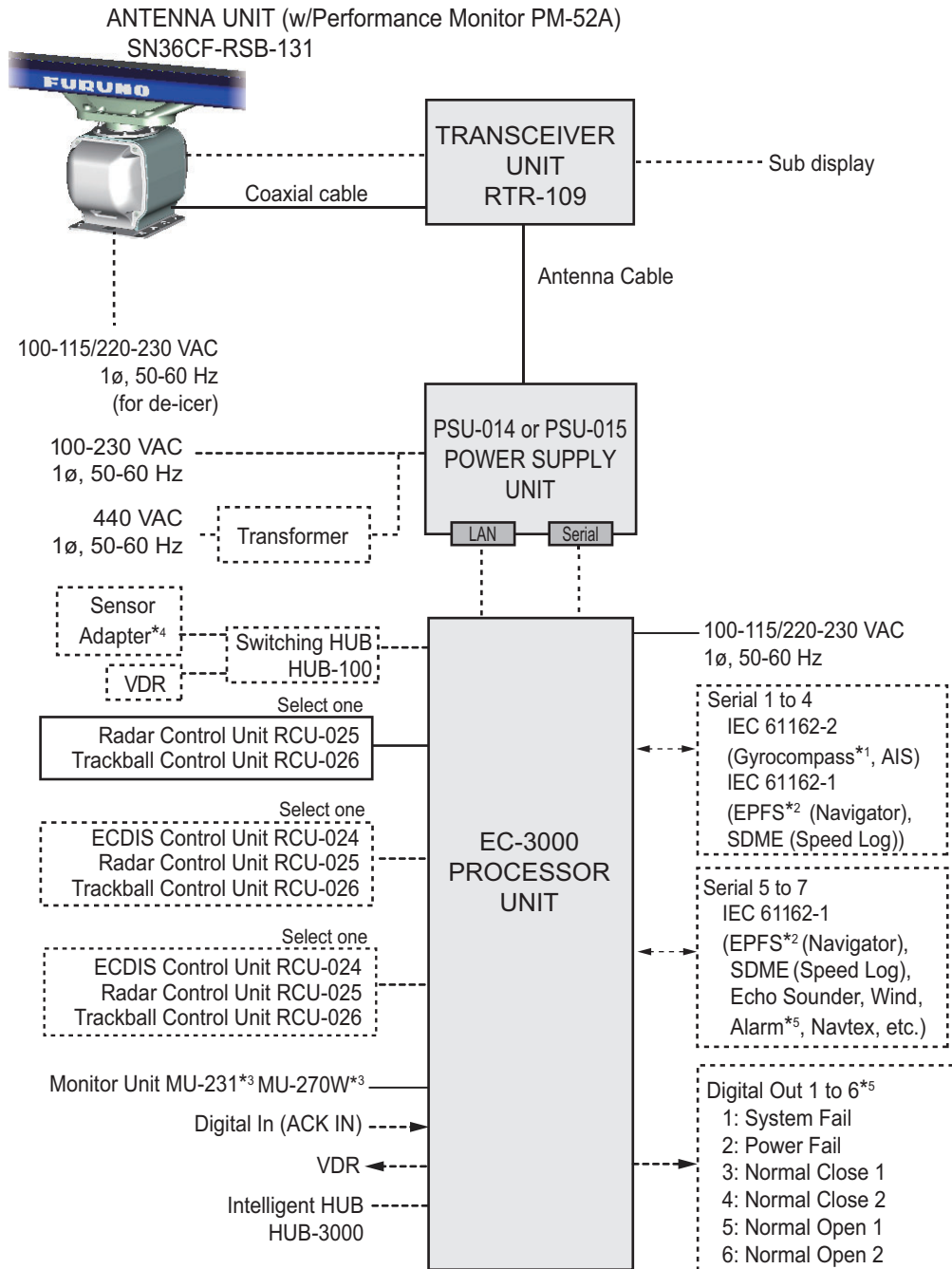

*: See the notes on page xxvi.

FAR-3230S-SSD/FAR-3330S-SSD/FAR-3230S-SSD-BB

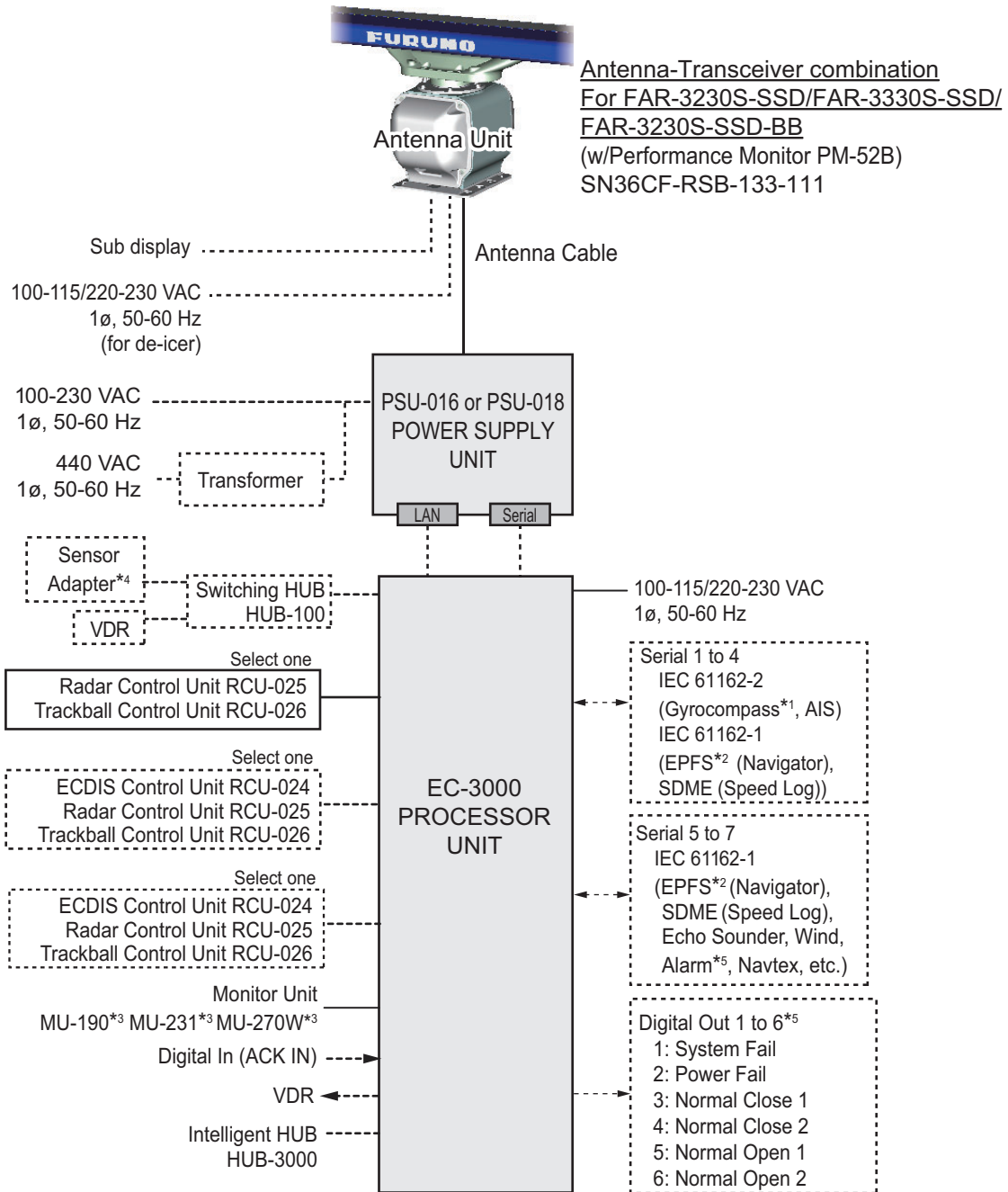

*: See the notes on page xxvi.

Category of units

Antenna units: Exposed to the weather
Other units: Protected from the weather

Notes

- 1) The gyrocompass must be type approved for compliance with IMO resolution A.424(XI) (and/or resolution A.821(19) for installation on HSC). The gyrocompass must also have an update rate that is adequate for the ship's rate of turn. The update rate must be better than 40 Hz (HSC) or 20 Hz (conventional vessel).
- 2) The EPFS must be type approved for compliance with IMO resolution MSC.96(72).
- 3) The monitors listed in the following table have been approved by the IMO.
If a different monitor is to be used on IMO vessels, its effective diameter must meet the applicable Category requirements.
 - CAT 1C and CAT 1HC: effective diameter of 320 mm or higher
 - CAT 2C and CAT 2HC: effective diameter of 250 mm or higher

Category	Maker	Model	Viewing distance
CAT 1C and CAT 1HC	FURUNO	MU-231	1.02 m
		MU-231CE	1.02 m
		MU-270W	1.02 m
	Hatteland Display	JH23T12FUD*	1.02 m
		JH23T14FUD	1.02 m
		HD26T22 FUD	0.99 m
		HD26T21 MMD	0.99 m
		HD27T22 FUD	1.07 m
		HD32T22 FUD	1.15 m
		HD55T22 FUD	1.95 m
North Invent	WA270-01.MON.01	1.07 m	
	WA460-01.MON.01	1.64 m	
CAT 2C and CAT 2HC	FURUNO	MU-190	1.02 m
		MU-201CE	1.08 m
	Hatteland Display	JH19T14FUD	1.02 m
		JH20T17FUD	0.88 m
		HD24T22FUD	0.86 m
	HD27T22FUD	0.97 m	
For installation and operation of other monitors, see the respective manuals. For BB types, a monitor unit is prepared by the user. *: For use with radar only; do not use for Back-up ECDIS.			

- 4) The sensor adapters are Control Serial MC-3000S, Analog IN MC-3010A, Digital IN MC-3020D and Digital OUT MC-3030D.
- 5) Characteristics of contact output for Alarm:
 - (Load current) 250 mA
 - (Polarity) Normally Open: 2 ports, Normally Close: 2 ports
 - Serial I/O for alarm is also possible, which complies with IEC 61162-1.
- 6) Junction boxes are required for antenna cable length greater than 100 m. Max. length is 400 m.
- 7) The ALR format is not BAM-compliant and shall not be used for new installation. It may be used for retrofitting on ships-in-operation only.
- 8) When using this unit as a Back-up ECDIS, the setup of the Back-up ECDIS must be completed by a FURUNO approved service engineer.
- 9) When setting up Operator Fitness and connecting this unit to the BNWAS, ensure the Monitor Unit and Control Unit are installed on the bridge where proper look-out can be carried out.

This page is intentionally left blank.

1. OPERATIONAL OVERVIEW

1.1 Radar Control Unit RCU-025

1.1.1 Radar Control Unit RCU-025 description

The Radar Control Unit RCU-025 consists of various controls and a trackball module (trackball, scrollwheel and left and right buttons). The trackball module functions like a PC mouse. The user rolls the trackball and operates the left and right buttons and the scrollwheel to do various functions.

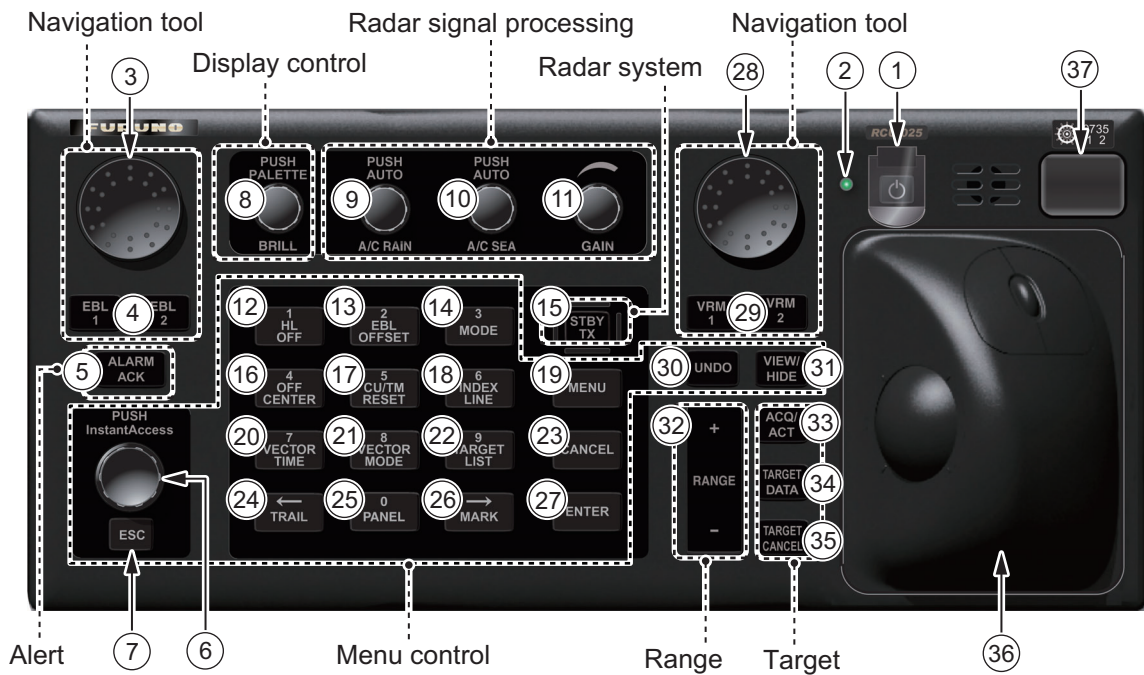

When you press the correct key, a single beep sounds to alert you to correct operation. For wrong operation, several beeps sound. You can select the loudness of the beep or deactivate the beep on the [Customize] menu.

No.	Control	Description
1		Turns the system on or off. (For configurations using a FURUNO monitor with the slide switch ON, this key also turns the monitor unit on or off.)
2	Status LED	The color and state of the LED change according to system or alert status. Green, lighting: Normal operation status; no alerts generated. Green, flashing: The heater on the CPU board is on, because ambient temperature is not at least 0°C. The heater takes about two minutes to warm the processor unit. The LED lights green after the heater goes off. Red, lighting: Acknowledged alert or SYSTEM FAIL. SYSTEM FAIL occurs when there is trouble in the Processor Unit or communication failure between the Processor Unit and a Control Unit. Each Control Unit detects trouble and its lamp flashes in red and the buzzer sounds. If this condition occurs at the No. 1 Control Unit, the SYSTEM FAIL signal is output. Red, flashing: Unacknowledged alert or SYSTEM FAIL.
3	Rotary control, EBL1, EBL2	Rotary control: Adjusts the active EBL. EBL1, EBL2: Activates or deactivates the respective EBL.

1. OPERATIONAL OVERVIEW

No.	Control	Description
5	ALARM ACK	<ul style="list-style-type: none"> • Acknowledges unacknowledged alert. • Silences the audio alarm.
6	InstantAccess knob	Selects the buttons on the InstantAccess bar™.
7	ESC	Goes back one step in current operating sequence on the InstantAccess bar™.
8	BRILL	<p>Rotate: Adjusts the brilliance of the display.</p> <p>Push: Selects a color palette.</p>
9	A/C RAIN	<p>Rotate: Suppresses rain clutter.</p> <p>Push: Toggles between manual and automatic rain clutter adjustment.</p>
10	A/C SEA	<p>Rotate: Suppresses sea clutter.</p> <p>Push: Toggles between manual and automatic sea clutter adjustment.</p>
11	GAIN	Rotate: Adjusts the sensitivity of the radar receiver.
12	HL OFF	<ul style="list-style-type: none"> • Temporarily erases everything except radar echoes when pressed and held down. • Enters the numeric 1. • Selects like-numbered menu item.
13	EBL OFFSET	<ul style="list-style-type: none"> • Activates or deactivates the offset EBL. • Enters the numeric 2. • Selects like-numbered menu item.
14	MODE	<ul style="list-style-type: none"> • Selects a presentation mode. • Enters the numeric 3. • Selects like-numbered menu item.
15	STBY TX	Toggles the radar between standby and TX.
16	OFF CENTER	<ul style="list-style-type: none"> • Puts sweep origin at the cursor location. • Enters the numeric 4. • Selects like-numbered menu item.
17	CU/TM RESET	<ul style="list-style-type: none"> • Course-up: Resets heading line to 000°. • True motion: Moves own ship position 75% of the radius in stern direction. • Enters the numeric 5. • Selects like-numbered menu item.
18	INDEX LINE	<ul style="list-style-type: none"> • Selects an index line (in the PI line box). • Long-press to activate or deactivate selected index line. • Enters the numeric 6. • Selects like-numbered menu item.
19	MENU	Opens, closes the menu.
20	VECTOR TIME	<ul style="list-style-type: none"> • Sets the vector time (length) for TT and AIS targets. • Enters the numeric 7. • Selects like-numbered menu item.
21	VECTOR MODE	<ul style="list-style-type: none"> • Sets the vector mode (relative, true) for TT and AIS targets. • Enters the numeric 8. • Selects like-numbered menu item.
22	TARGET LIST	<ul style="list-style-type: none"> • Displays AIS, TT data in the target list. • Enters the numeric 9. • Selects like-numbered menu item.
23	CANCEL	Cancels the changes made on the currently selected menu.
24	TRAIL	<ul style="list-style-type: none"> • Goes back one page in the menu. • Moves cursor leftward in text box. • Turns the echo trail display on or off. • Long-press to reset all trails.

No.	Control	Description
25	PANEL	<ul style="list-style-type: none"> • Adjusts the backlighting of the keys. • Enters the numeric 0. • Selects like-numbered menu item.
26	MARK	<ul style="list-style-type: none"> • Goes forward one page in the menu. • Moves cursor rightward in text box. • Inputs selected mark on the radar screen, at the position selected.
27	ENTER	Confirms selection on menu.
28	Rotary control,	Rotary control: Adjusts the diameter of the active VRM. VRM1, VRM2: Activates or deactivates the respective VRM.
29	VRM1, VRM2	
30	UNDO	Undoes edit or text input when creating a radar map, route, user chart.
31	VIEW/HIDE	Radar mode, chart radar mode: Shows or hides the AZ box, Drop mark boxes, Mark box, PI line box, Trial box. Chart for radar mode: Shows or hides the EBLs, InstantAccess bar™, [Overlay/NAV Tools] box, [Route information] box, VRMs.
32	RANGE	Selects radar range (radar and chart radar modes), chart scale (chart mode).
33	ACQ/ACT	<ul style="list-style-type: none"> • TT: Acquires cursor-selected target, for target tracking. • AIS: Activates cursor-selected sleeping AIS target.
34	TARGET DATA	Displays the detailed data for selected TT, AIS target, in the TT/AIS information box.
35	TARGET CANCEL	<ul style="list-style-type: none"> • TT: Stops tracking cursor-selected tracked target. • AIS: Sleeps cursor-selected activated AIS target. • Long-press to erase all displayed TT target data.
36	Trackball module	The trackball module is the same as that used in the Trackball Control Unit RCU-026. See the description in the next section.
37	USB port	For connection of USB flash memory (FAT16 or FAT32 format). Do not connect a USB HDD or PC keyboard. The DVD drive (Maker: TEAC, Type: PU-DRV10) is for chart updates.

1.1.2 Operator fitness

The system outputs the operator fitness signal when a key or button is pressed, the trackball is moved or a rotary control is rotated.

1.2 Trackball Control Unit RCU-026

1.2.1 Trackball Control Unit RCU-026 description

The Trackball Control Unit RCU-026 has a power switch, a trackball module (trackball, scrollwheel and left and right mouse buttons), a status LED, and a USB port. The trackball module functions like a PC mouse; the user rolls the trackball and operates the left and right buttons and the scrollwheel to do various functions.



No.	Control	Description
1	Power switch	Turns the system on or off. (For configurations using a FURUNO monitor with the slide switch ON, this key also turns the monitor unit on or off.)
2	Status LED	The color and state of the LED change according to system or alert status. See the Status LED description on page 1-1.
3	Left button	<ul style="list-style-type: none"> • Does the operation related to the object selected. • Confirms the operation done for the object selected.
4	Scrollwheel	<ul style="list-style-type: none"> • Selects menu options. • Selects chart scale. • Sets numeric data. (The scrollwheel does not have a "push" function.)
5	Right button	<ul style="list-style-type: none"> • Displays context-sensitive menu when the cursor is put in the display area. • Cancels operation done on the object selected.
6	Trackball	<ul style="list-style-type: none"> • Moves the cursor. • Selects an object.
7	USB port	For connection of USB flash memory (FAT16 or FAT32 format). Do not connect a USB HDD or PC keyboard.

1.2.2 Operator fitness

The system outputs the operator fitness signal when a key or button is pressed, the trackball is moved or a rotary control is rotated.

1.3 Processor Unit EC-3000

The Processor Unit is the heart of the chart system, and is mainly responsible for the chart management, route planning and route navigation.

The Processor Unit has two power switches. The Mains switch controls the power from the switchboard, and the Power switch controls the power to the chart radar system.

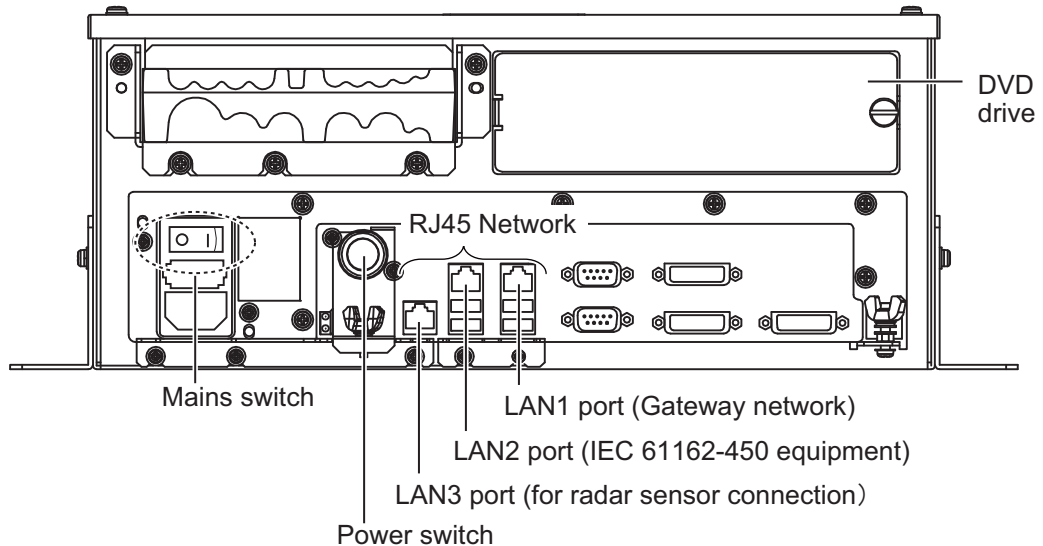

Note 1: Do not operate the chart radar with a DVD or CD inserted in the DVD drive, to prevent damage to the drive and media. Remove media from the drive after usage. Insert media only to update charts. After completion of an update, remove the media from its drive and store it in its case. Store media out of direct sunlight, in a place where temperature and humidity are moderate and stable.

Note 2: To keep the system stable, restart the unit at least once every two weeks.

Note 3: Close the lid of the DVD drive when the drive is not in use.

1.4 How to Turn the System On/Off

Normally, leave the power switches at the front of the Processor Unit on and control the power with the power switch on a Control Unit (RCU-025, RCU-026). The monitor unit is powered independently.

How to power the system

Push the mains switch on the Processor Unit for the "I" position. Turn on the power switch on the Processor Unit or a Control Unit. The start-up display appears on the monitor.

After the power is applied, the program starts up and about one minute later the bearing scale appears. The radar then goes into three minutes of warm-up time to warm the magnetron, which transmits radar pulses. The timer at the center of the screen counts the time remaining for warm-up. When the timer shows 0:00, the indication "ST-BY" appears at the screen center. The radar is now ready to transmit radar pulses. In the stand-by condition, no radar pulses are transmitted and TT nor AIS is active.

The settings on the menus are stored in a non-volatile memory (hard disk) and are preserved when the power is turned off.

Note 1: The solid state radar does not have a magnetron, therefore it has no warming period.

Note 2: If the ambient temperature is less than 0°C (32°F) when the power is applied, nothing appears on the display and the Status LED on the Control Unit flashes. This is because the heater is warming the unit. The display appears in approx. two minutes.

How to power off the system

Press the power switch on the Processor Unit or a Control Unit. Push the Mains switch for the "O" position.

Note: Provided that the radar was once in use with the transmitter tube (magnetron) still warm, you can put the radar in transmit state without three minutes of warm-up. If the Power switch was turned off by mistake or the like and you wish to restart the radar promptly, turn on the Power switch not later than 10 seconds after power-off.

1.5 How to Select a Color Palette

This radar provides three sets of color and brilliance sets (palette), day, dusk and night, to match any ambient lighting condition. The default specifications of each palette are as shown in the table below. The panel dimmer setting is automatically changed, and the number of steps depends on the color palette selected.

Palette	Brilliance		Panel dimmer (step)	Text color	Background color
	19" display unit	23"/27" display unit			
Day-gray	110cd/m ²	120cd/m ²	9	White	Gray
Day-blue	110cd/m ²	120cd/m ²	9	White	Blue
Dusk-gray	50cd/m ²	50cd/m ²	8	Light gray	Dark gray
Dusk-blue	50cd/m ²	50cd/m ²	8	Light gray	Dark blue
Night-gray	5cd/m ²	5cd/m ²	5	Orange	Dark gray
Night-blue	5cd/m ²	5cd/m ²	5	Light gray	Dark blue

To select a palette, do the following:

1. Click the [Palette] button.

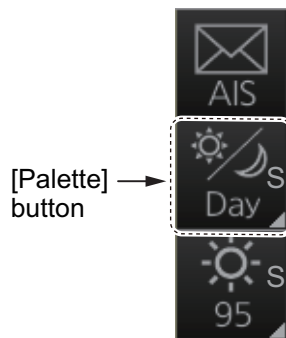

2. Click [Day], [Dusk] or [Night] as appropriate. For example, select [Day] to show its options.



3. Click the palette (gray, blue) desired.

Note 1: A palette can also be selected by pushing the **BRILL** control on the Control Unit.

Note 2: S or L appears at the right edge of the button to denote sharing method. See section 22.6.

1.6 How to Adjust the Display Brilliance, Control Unit Backlighting

The brilliance setting is defined according to the color palette setting (see section 1.5). However, manual adjustment of the brilliance is also possible.

Note 1: Use a serial cable for brilliance adjustment to make the connection between the Processor Unit and the Control Unit.

Note 2: For details regarding your monitor, see its operator's manual.

Note 3: Improper brilliance may affect the visibility of information, especially on the night display.

Note 4: S or L appears at the right edge of the button to denote sharing method. See section 22.6.

1.6.1 Manual brilliance adjustment

How to adjust the brilliance manually with the BRILL control

Operate the **BRILL** control to adjust brilliance. Turn it clockwise to increase the brilliance; counterclockwise to decrease the brilliance. Watch the brilliance level indication on the [BRILL] button (see the illustration below) to see the current brilliance level.

How to adjust the brilliance manually with the InstantAccess knob

1. Push the **InstantAccess** knob.
2. Rotate the knob to select the [BRILL] button then push the knob to show the brilliance adjustment window.

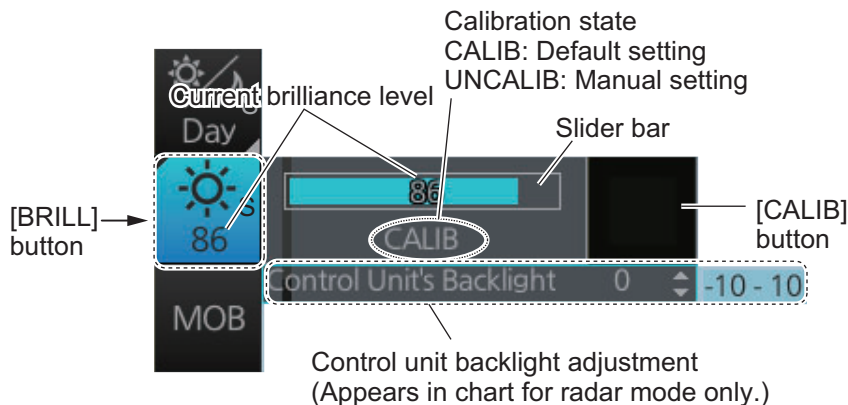

3. Push the knob, rotate the knob to set the brilliance then push the knob to confirm the setting. The calibration state indication changes to "UNCALIB".
4. To restore the default setting, rotate the knob to select the [CALIB] button then push the knob. The calibration state indication changes to "CALIB".

Manual brilliance adjustment with the trackball module

1. Click the [BRILL] button on the InstantAccess bar™ to show the brilliance adjustment window.
2. **For coarse adjustment**, put the cursor on a location within the slider bar area then push the left button. **For fine adjustment**, put the cursor on the end of the slider bar and roll the trackball while holding down the left button.

3. Release the left button to confirm setting. The calibration state indication changes to "UNCALIB".
4. To restore the default setting, click the [CALIB] button. The calibration state indication changes to "CALIB".

1.6.2 Control unit backlighting

How to adjust the brilliance manually with the control unit (RCU-025)

Push the **PANEL** key to adjust backlighting of the control unit.

How to adjust the brilliance manually on the menu (For Radar mode and Chart radar mode)

1. Right-click the **BRILL** button on the InstantAccess bar™ then select [Brill Menu].
2. Adjust the backlighting on the [1 CONTROL PANEL] menu.

How to adjust the brilliance manually with the InstantAccess knob (For chart mode)

1. Push the **InstantAccess** knob.
2. Rotate the knob to select the [BRILL] button then push the knob to show the brilliance adjustment window.
3. Put the cursor on the backlighting setting, and up and down arrows appear. Click the arrows to adjust the backlighting.

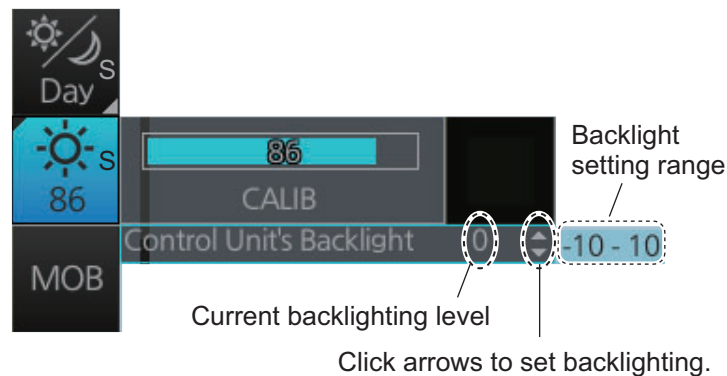

1.7 Display Modes

This chart radar has the following display modes:

- [RADAR]: - The **radar mode** provides the traditional radar display.
- The **chart radar mode** overlays the electronic chart on the radar image.
- [CHART for RADAR]: The **chart mode** shows the electronic charts.
- [CONNING for RADAR]*: The **conning mode** provides a comprehensive navigation data display. * Optional specification.

1.7.1 How to select a display mode

Click the Display mode button to select desired mode.

- [RADAR]: Radar or chart radar mode (see subsection 1.8.2)
- [CHART for RADAR]: Chart for radar mode
- [Back-up ECDIS]: Back-up ECDIS mode (replaces [CHART for RADAR])
- [CONNING for RADAR]: Conning mode (see section 24.1)

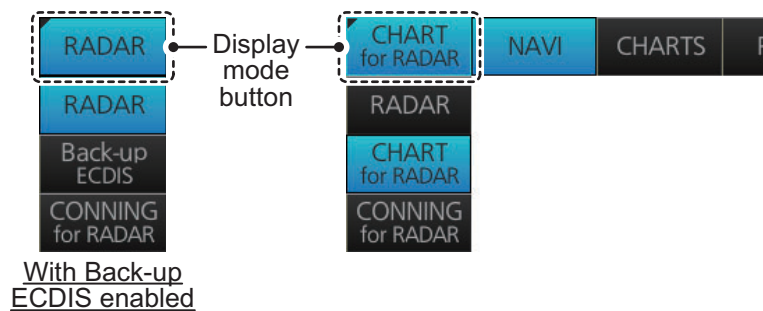

1.7.2 Limitations when using the chart radar mode

The presentation mode for the chart radar mode can be course-up RM, north-up RM, or north-up TM. The presentation mode is automatically switched to north-up RM if the mode is head-up at the time the chart radar mode is selected.

1.7.3 Limitations when using Back-up ECDIS mode

When Back-up ECDIS mode is enabled, the following changes are also applied.

- The [CHART for RADAR] button changes to read "Back-up ECDIS".
- Own Ship look-ahead Area is always active and cannot be turned off.
- The talker for some sentences (route/alerts) changes from "RA" to "EI".

1.8 Display Screens

All display screens have operational buttons, boxes and indications, and display markers. Click a button or indication to execute the related operation. Context-sensitive menus are available with several boxes and objects. Right-click the appropriate box or object to show the related context-sensitive menu.

Monitor viewing distance

The optimal viewing distance for the FURUNO-supplied monitors is 1020 mm.

1.8.1 Radar display

The illustration below shows the markers, data, etc. as they appear on the FURUNO 19-inch monitor unit. The layout for the 23-inch and 27-inch monitor unit is partially different - the  button appears on the bottom of the InstantAccess bar™.

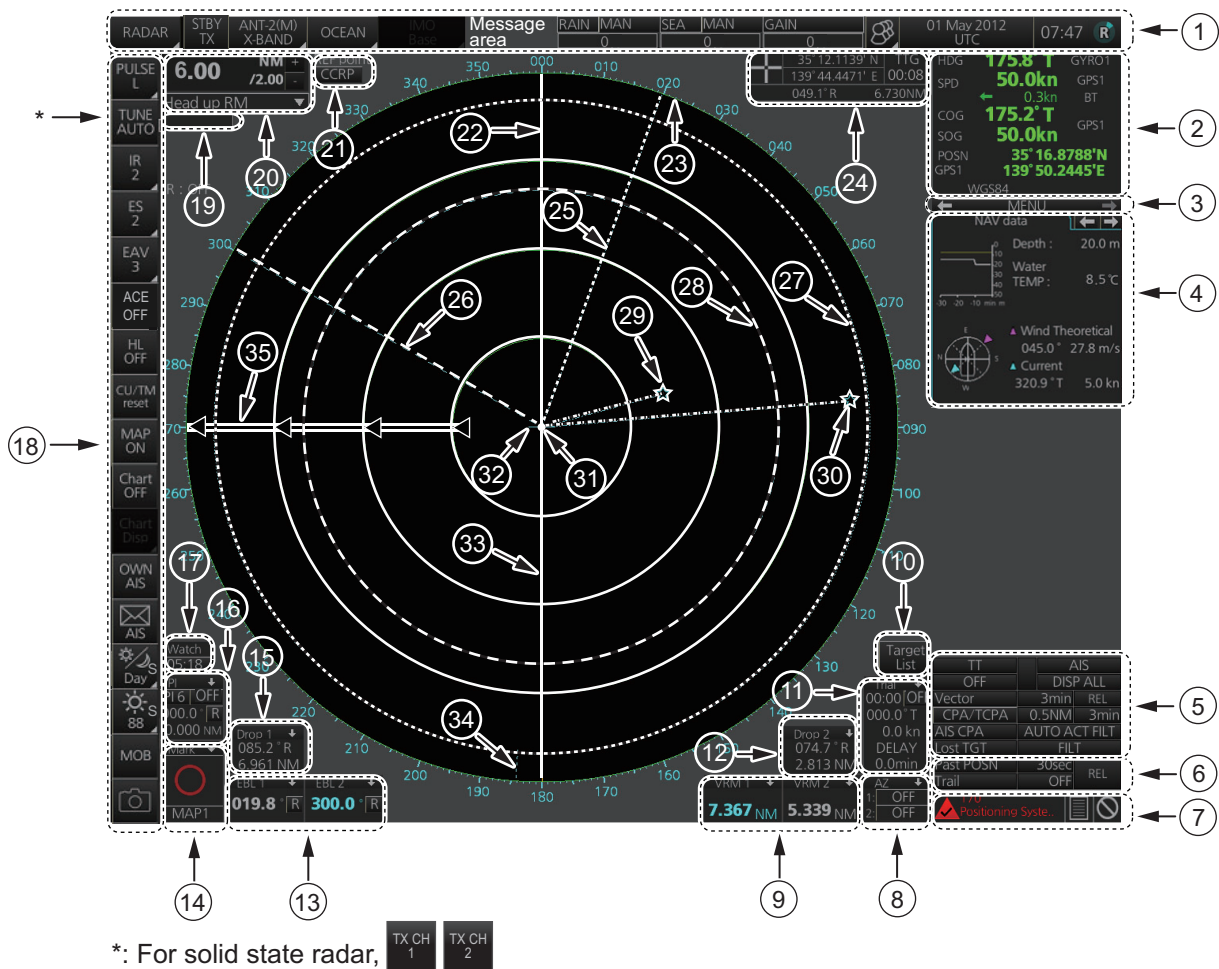

No.	Name	Description
1	Status bar	<ul style="list-style-type: none"> Selects an antenna. Selects the mode. Adjusts the radar picture. Displays radar operational messages.

1. OPERATIONAL OVERVIEW

No.	Name	Description
2	Sensor information, datum box	Shows your ship's heading, heading source, ship's speed, water tracking speed, speed source, course over ground, speed over ground, course and speed source, ship's position, position source, chart datum. Note: Position source shall meet the requirements of IMO MSC.112(73).
3	Menu	Drop-down menu with various radar and chart functions.
4	Information box	Provides various navigation data and route information.
5	TT/AIS setting box	Sets the parameters for TT and AIS targets.
6	Trail box	Sets the parameters for the target trails.
7	Alert box	Shows alert messages by alert name and alert number. <ul style="list-style-type: none"> Unacknowledged or regenerated alerts flash in red (alarm) or yellow-orange (warning). Acknowledged alerts are shown in normal video.
8	Acquisition zone box	Sets an acquisition zone for TT, AIS.
9	VRM boxes	Shows the range and TTG to the VRM1, VRM2.
10	Target list button	Displays the TT and AIS target list.
11	Trial maneuver box	Sets the parameters for the trial maneuver.
12	Drop mark 2 box	Shows the bearing and range to the drop mark 2.
13	EBL boxes	Shows the bearing to the EBL1, EBL2.
14	Mark box	Selects the mark to inscribe on the radar display.
15	Drop mark1 box	Shows the bearing and range to the drop mark 1.
16	PI line box	<ul style="list-style-type: none"> Adjusts the direction and width of the parallel index lines. Activates or deactivates the parallel index lines.
17	Watch box	Counts down the time remaining until the buzzer sounds to alert the operator to view the radar picture.
18	InstantAccess bar™	Quick access to often-used radar, chart radar and chart functions. For radar and chart radar functions, see section 1.10. For chart functions, see subsection 6.1.3.
19	Tuning bar	Shows tuning status. (No function with solid state radar.)
20	Range/Presentation mode box	<ul style="list-style-type: none"> Selects the radar range. Selects the presentation mode.
21	REF point box	Selects the reference point (antenna or CCRP) for measurements (range, bearing, etc.) and markers (position, etc.)
22	Heading line	Indicates ship's heading.
23	Bearing scale	The bearing scale provides an estimate of the bearing to a target.
24	Cursor position box	This box shows <ul style="list-style-type: none"> Latitude and longitude of the cursor position. Range and bearing to the cursor position. TTG to the cursor position.
25	EBL1	Measures the bearing to a target.
26	EBL2	
27	VRM1	Measures the range to a target.
28	VRM2	
29	Drop mark 1	Finds the range and bearing to drop mark position.
30	Drop mark 2	
31	Antenna marker	A cross marks antenna position.
32	Own ship marker	An inverted "T" marks your ship's position.
33	Stern marker	Marks location of stern.
34	North marker	Marks North.
35	Range rings	Provide an estimate of the range to a target.

How to minimize, maximize the boxes at the bottom of the screen

The boxes at the bottom of the screen that contain an arrow can be minimized. Click the arrow to minimize the box. To restore maximum size, click the minimized box.

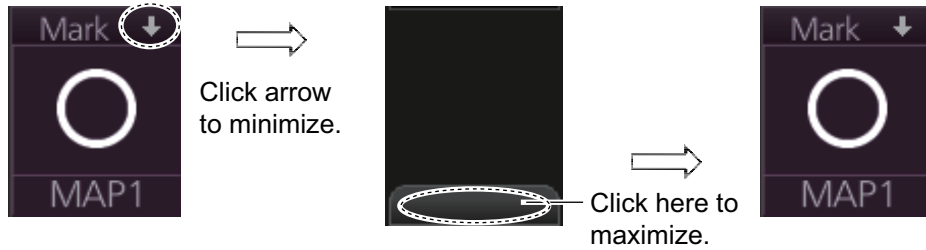

Example: Mark box

Note: The respective VRM or EBL is erased from the screen when the corresponding VRM or EBL box is minimized.

1.8.2 Chart radar display

The chart radar display overlays an electronic chart on the radar picture. To switch between the radar and chart radar displays, click the [Chart ON/OFF] button on the InstantAccess bar™.

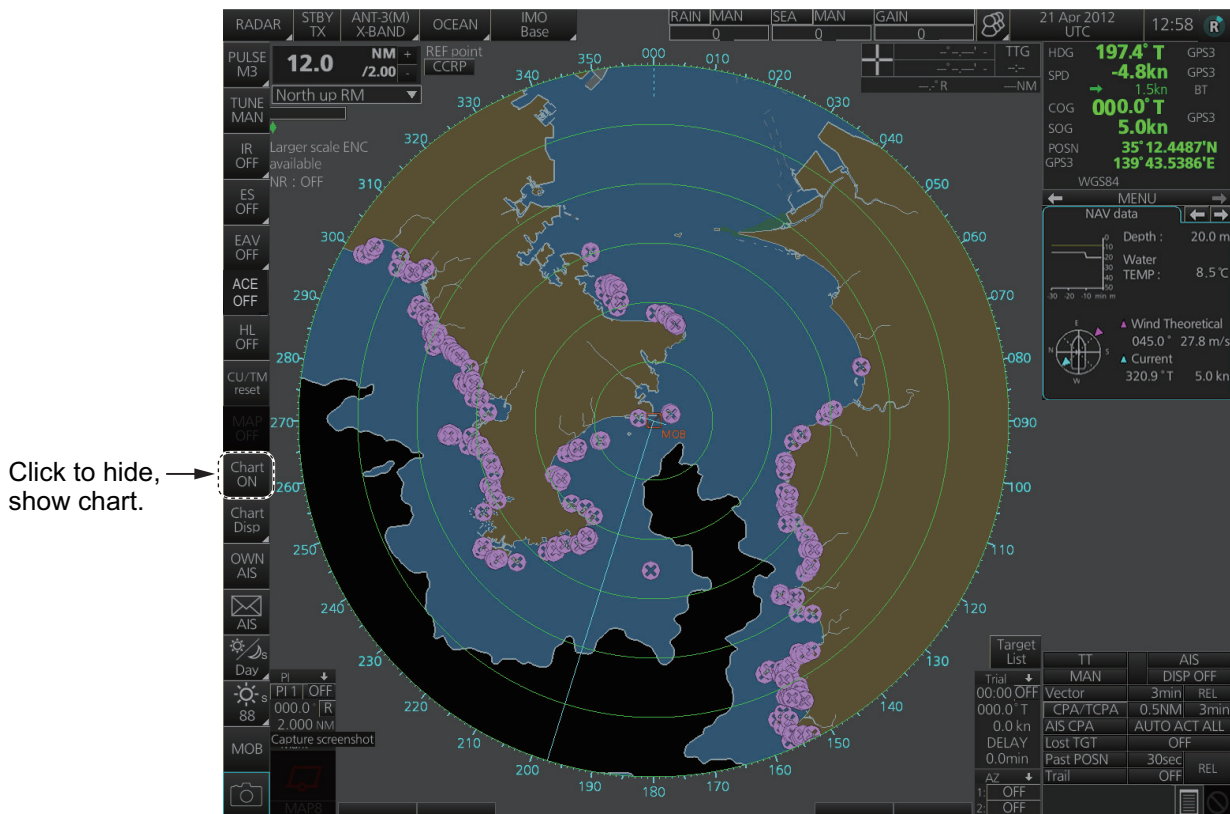

1. OPERATIONAL OVERVIEW

1.8.3 Chart display

The chart display shows only the electronic chart. Click the Display mode button to select [CHART for RADAR] to activate this display. See chapter 6 or a description of the chart display.

Select [CHART for RADAR].

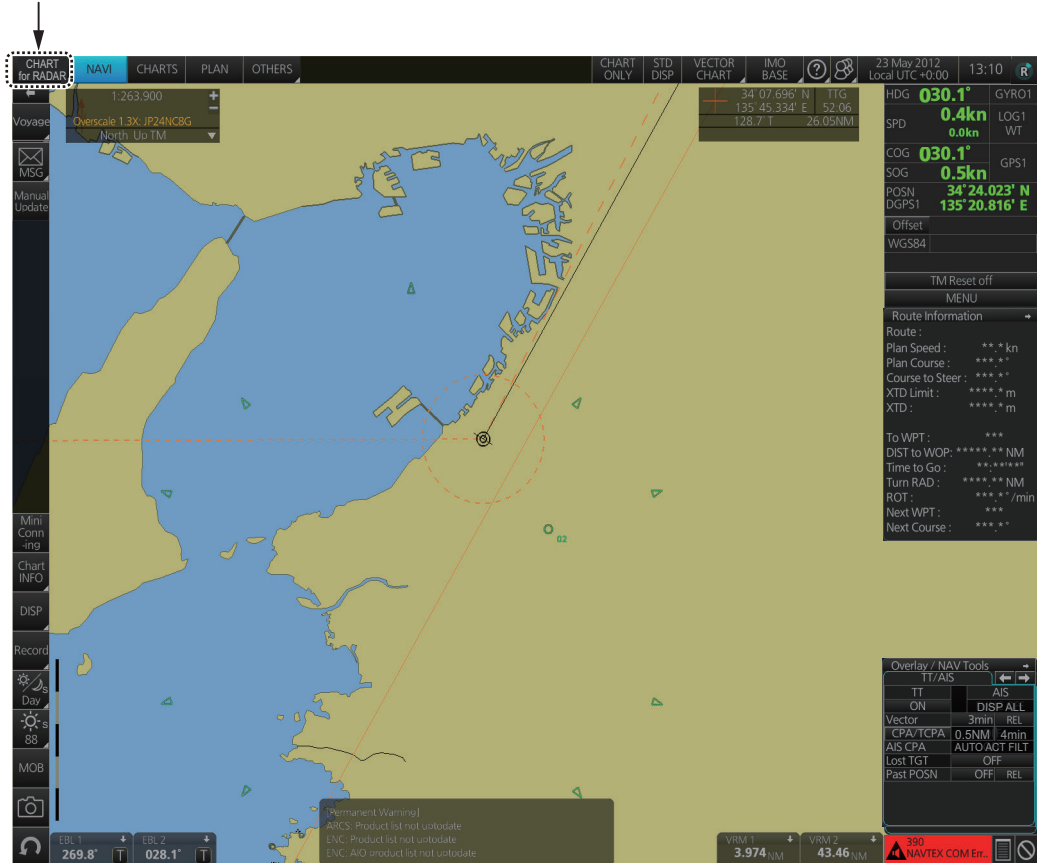



1.9 Status Bar

The Status bar is displayed at the top of screen in all modes. This bar provides, in the radar and chart radar modes, buttons for selection of the mode, antenna and chart database, and adjustment of the radar picture.

For a description of the Status bar used in the chart for radar mode, see subsection 6.1.2. For a description of the Status bar used in the conning mode, see section 24.1.

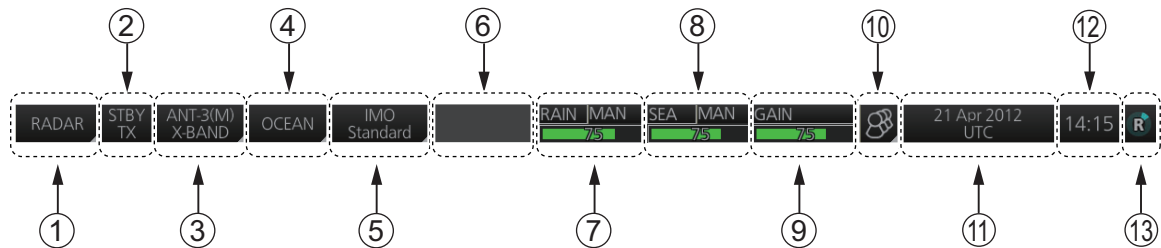
1.9.1 Status bar for radar, chart radar mode





No.	Button name	Description
1	Display Mode	Selects the display mode: [RADAR], [CHART for RADAR], [CONNING for RADAR]*. * Optional specification.
2	STBY TX	Toggles the radar between stand-by and transmit.
3	Antenna	Selects an antenna.
4	Customize Echo	Presets the radar controls for specific navigation purpose; for example, congested waters.
5	Chart database	Selects the chart database (IMO Base, IMO Primary, IMO Standard, IMO All or PERSONAL).
6	Message area	Displays the message or icon.
7	RAIN*	Reduces rain clutter.
8	SEA*	Reduces sea clutter.
9	GAIN	Adjusts the gain of the radar receiver.
10	Settings 	Manages user profiles; opens the Settings menu.
11	Date	<ul style="list-style-type: none"> Displays the date. Selects the time to use, local or UTC. Sets the time difference between local and UTC (to use local time).
12	Time	Displays the time, local or UTC.
13	Working Indicator 	<ul style="list-style-type: none"> Rotates clockwise if the system is working properly. If it is not spinning the system is not working. Shortly after the working indicator stops spinning the buzzer sounds and the status LED turns red. Reset the power to restore normal operation. If the primary display mode is specified during installation, the first letter of the primary mode name appears at the center of the working indicator as follows: C: Conning, E: ECDIS, R: Radar. The letter can be clicked to return to the primary display mode.

*: The indication is grayed out when the Automatic Clutter Elimination (ACE) function is [ON].

1.9.2 How to operate the buttons, slider bars on the Status bar

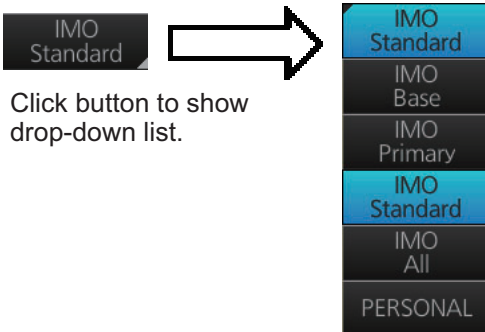
The Status bar has three types of controls: toggle button, drop-down list button and slider bar. You operate the buttons and bars with the trackball module.

Control type	Example of control
<p>Toggle button</p> <p>A toggle button alternately selects one of two functions assigned to the button. For example, the [STBY TX] button toggles the radar between stand-by and TX. The background color of the [STBY TX] button momentarily changes to light-blue when switching from standby to TX.</p>	
<p>Drop-down list button</p> <p>A drop-down list button provides a list from which to select an option related to the label on the button. A drop-down list button is identified by a triangle on the button's bottom-right corner. The [Chart database] button, shown in the right figure, is an example of a drop-down list button.</p>	 <p>Click button to show drop-down list.</p>
<p>Slider bar</p> <p>The slider bars provide for adjustment of the radar picture. [RAIN], [SEA] and [GAIN] are slider bar buttons. To adjust the bar coarsely, put the cursor at any location within the slider bar area then push the left button. For fine adjustment, put the cursor at the end of the slider bar and roll the trackball while holding down the left button. Release the button to finish.</p>	

1.10 InstantAccess Bar™

The InstantAccess bar™ runs vertically along the left edge of the screen and is displayed always. This bar provides, in the radar and chart radar modes, buttons for adjustment of the radar picture and chart, AIS operations, display brilliance control, MOB, screenshot, etc.



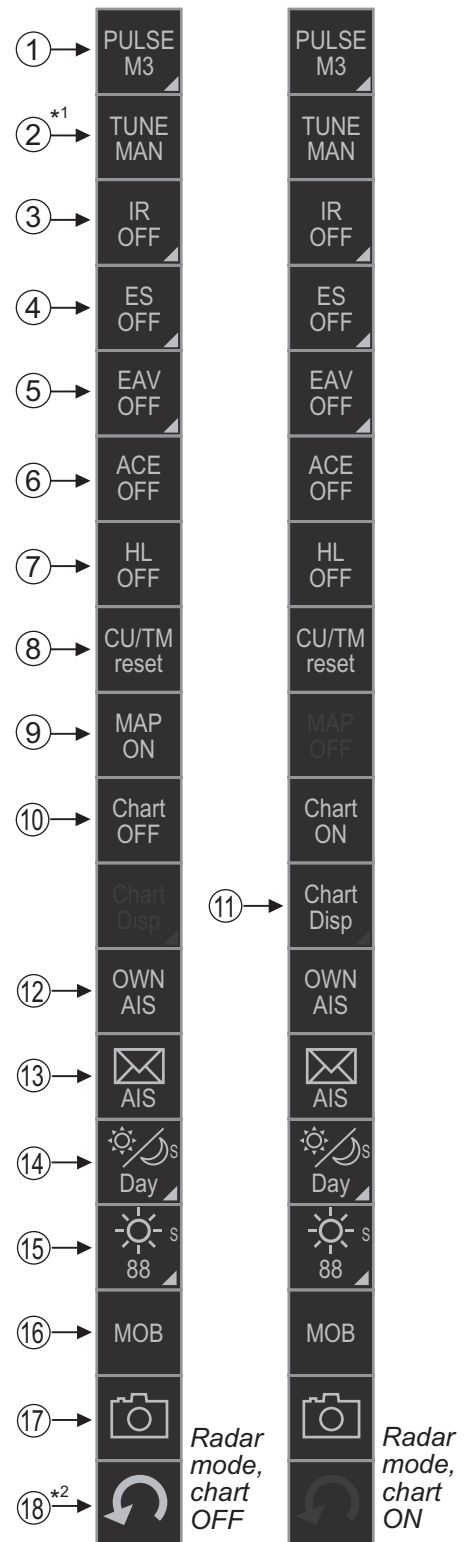

For a description of the InstantAccess bar™ used in the chart mode, see subsection 6.1.3.

*1: For solid state radar, [TX CH] icon is displayed instead of [TUNE].

*2: This button is not displayed on the FURUNO 19-inch monitor unit.



1. OPERATIONAL OVERVIEW

No.	Button name	Description
1	PULSE	Selects the radar pulse length.
2	TUNE (Magnetron radar)	Selects the radar receiver tuning method, automatic or manual, and manually tunes the radar receiver.
	TX CH (solid state radar)	Selects the transmit frequency from [TX CH 1] or [TX CH 2]. If your radar is receiving interference from another radar operating at the same frequency, use the [TX CH] button to change the TX frequency.
3	IR	Activates or deactivates the interference rejector.
4	ES	Activates or deactivates the echo stretch.
5	EAV	Activates or deactivates the echo averaging when Automatic Clutter Elimination (ACE) function is off.
6	ACE	Activates or deactivates the Automatic Clutter Elimination (ACE) function. Automatic Clutter Elimination (ACE) automatically sets the gain, rain and sea clutter controls according to the sea and rain clutter states.
7	HL OFF	Temporarily erases everything but radar echoes.
8	CU/TM reset	<ul style="list-style-type: none"> • Puts the ship's heading at the top of the screen in course-up mode the moment this button is pressed. • Resets the ship's position to a point of 75% radius opposite to the extension of the heading line passing through the display center in true motion modes.
9	MAP ON/OFF	Shows or hides the radar map marks on the radar display, in the radar mode.
10	CHART ON/OFF	Shows or hides the electronic chart.
11	Chart Disp	Shows or hides various chart objects. Shown in the chart radar mode. See subsection 2.43.2.
12	OWN AIS	Shows the [VOYAGE DATA] menu, to set your ship's AIS data.
13	 AIS message	Displays screen for "received AIS messages".
14	 Palette	Selects a color palette, day, dusk or night. The S or L at the right edge of the label indicates how the color palette selection is shared, among the units of the system (S) or locally (L). The default setting is "S". See section 22.6.
15	 BRILL	<ul style="list-style-type: none"> • Adjusts the brilliance of the monitor. • Adjusts the backlighting for the control unit. (CHART for RADAR mode) <p>The S or L at the right edge of the label indicates how the brilliance/backlighting selection is shared, among the units of the system (S) or locally (L). The default setting is "S". See section 22.6.</p>
16	MOB	Enters a MOB mark at the current position.
17	 Capture	Takes a screenshot.
18	 UNDO	Restores previous condition in radar map and text input.

1.10.1 How to operate the buttons, slider bars on the InstantAccess bar™

The InstantAccess bar™ has three types of controls: toggle button, drop-down list button and slider bar. (The MOB and Capture buttons are special buttons.) You operate the buttons and bars with the trackball module or the **InstantAccess** knob. This section shows you how to use the **InstantAccess** knob.

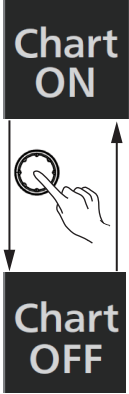
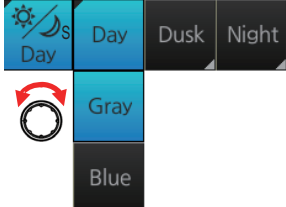
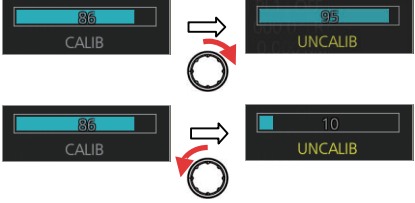
Toggle button	Drop-down list button	Slider bar
	<p>A drop-down list button provides a list from which to select an option related to the label on the button. A drop-down list button is identified by a triangle on the button's bottom-right corner.</p> <p>[Palette] button</p>  <p><i>Palette list</i></p>	

1. Push the **InstantAccess** knob to enable its use with the InstantAccess bar™.
2. Rotate the **InstantAccess** knob to select a button. The background color of the button selected is light-blue.
3. Do one of the following depending on button type.
 - 1) **Toggle button**: Push the knob to select setting.
 - 2) **Drop-down list button** or **slider bar**: Push the knob then rotate the knob to select an item or adjust the slider bar. Push the knob to confirm your selection.

Note: You can use the **ESC** key to go back one step in the current operating sequence.

1.11 Sensor Information, Datum Box

Sensor information, datum box displays the sensor data and the name of the datum in use. If the selected sensor's signal is interrupted or lost, the system automatically switches to a usable sensor. The sensor indications and names are colored according to sensor state. See the table below.

- **HDG:** Heading and its source.
- **SPD:** Longitudinal speed and its source. The direction of transverse speed is indicated with arrows, ➡, Starboard, ⬅, Port.
- **COG:** Course over ground and its source.
- **SOG:** Speed over ground and its source.
- **POSN:** Latitude and longitude position of own ship and its source.
- **Datum:** Chart datum (WGS84, WGS72, etc.) in use. No datum appears when there is no datum sentence.



Note: The position source shall meet the requirements of IMO MSC.112(73).

Color of nav data indications and sensor name

The color of the nav data indications and sensor names changes according to the state of the sensor data. The table shown below provides basic indication and color meanings. For detailed information, see Appendix 3. When no sensor data is received, the sensor source indication is blank and the related indication shows asterisks.

Nav data indication	Color of nav data indication	Color of sensor name	State
<p>HDG 141.0° T GPS1 SPD -3.0kn GPS1 ➡ 4.6kn BT COG 262.7° T GPS1 SOG 5.5kn POSN 35° 37.9964'N GPS1 139° 45.8268'E</p>	Green	White	Sensor is normal.
<p>HDG 285.5° T GYRO1 SPD 12.5kn GPS1 ➡ 0.3kn COG 286.0° T GPS1 SOG 13.1kn POSN 30° 00.0000'N GPS1 020° 00.0000'E</p>	Yellow	White	Validity of data is low or offset is applied.
<p>HDG 285.5° T GYRO1 SPD 12.5kn GPS1 ➡ 0.3kn COG 286.0° T GPS1 SOG 13.1kn POSN 30° 00.0000'N GPS1 020° 00.0000'E</p>	Yellowish-orange	Yellowish-orange	Integrity check failed
<p>HDG ***.° T SPD 12.5kn GPS1 ➡ 0.3kn COG 286.0° T GPS1 SOG 13.1kn POSN 30° 00.0000'N GPS1 020° 00.0000'E</p>	Green, data shown with asterisks (**.*)	No display	Data is not being received.
<p>HDG 285.5° T MAN SPD 12.5kn MAN ➡ 0.3kn COG 286.0° T GPS1 SOG 13.1kn POSN 30° 00.0000'N DR 020° 00.0000'E</p>	Yellow	White	Data is input manually (manual heading, gyro correction, manual speed, dead reckoning).

Note: Depending on settings selected at installation, the integrity check (see section 16.7) result colors can be changed. In this case, nav data color changes according to status as follows:

- [Passed]: Green
- [Doubtful]: Yellow
- [Failed], [Not Available] or [Excluded]: Bright Yellow

1.12 Menu Overview

The menu consists of eight main menus and several sub menus. You can operate the menu with the Radar Control Unit or trackball module. The system closes open menus whenever there is no menu operation for 30 seconds.

1.12.1 Basic menu operation

1. Open the main menu.

Control Unit: Press the **MENU** key.

Trackball module: Click the menu title bar at the right side of the display.

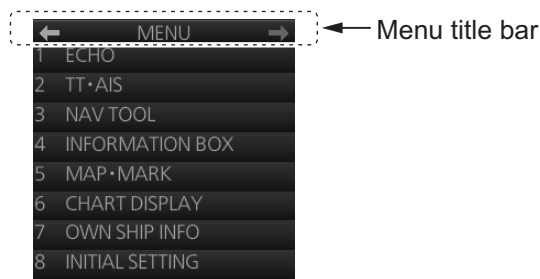

2. Select a menu.

Control Unit: Press the corresponding numeric key. For example, press the **3** key to show the [NAV TOOL] menu.

Trackball module: Click the menu desired. The current selection is highlighted in blue.

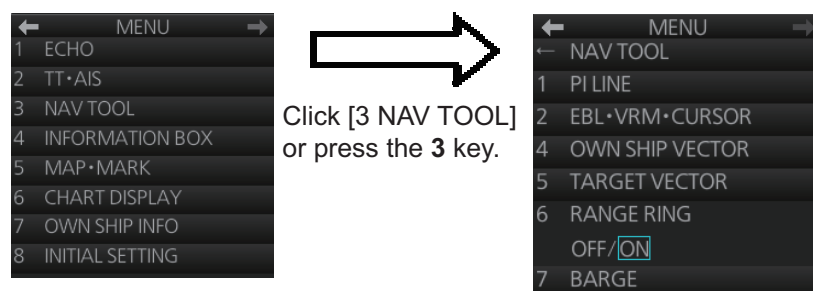

3. Select a menu item.

Control Unit: Press the corresponding numeric key.

Trackball module: Click the menu item desired. The current selection is highlighted in blue.

4. Select a menu option.

Control Unit: Press the corresponding numeric key. The current selection is highlighted in orange.

Trackball module: Spin the scrollwheel. The current selection is highlighted in orange.

1. OPERATIONAL OVERVIEW

5. Confirm your selection.

Control Unit: Press the **ENTER** key.

Trackball module: Push the left button.

Note: Hereafter, "select" in a menu operating procedure means to press the applicable numeric key on the Control Unit or push the left button on the trackball module.

Keys, buttons to use in menus

Control Unit

MENU key: Open main menu, or close menu.

CANCEL key: Go back one layer in menu, or close menu when main menu is displayed.

←key: Return to main menu, in no. 2 layer or higher.

Trackball module

Right button: Go back one layer, or close menu when main menu is displayed.

Left button: (1) Click menu title bar to go back one layer, or close menu when main menu is displayed, (2) Click the left arrow on the menu title bar to return to the main menu, in no.2 layer or higher.

1.12.2 Menu history feature

This chart radar remembers the 10 last-used menus to help you go to recently used menus quickly. The memorized menus are cleared when the power is turned off. Installation- and service-related menus and menus where no operation occurred are not memorized. Menus accessed multiple times are counted as one menu.

Click the memory history buttons on the menu title bar to navigate through the last-used menus.

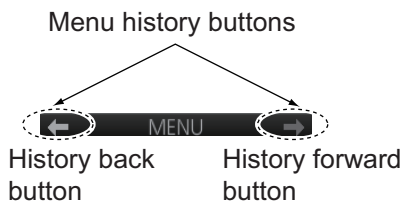

For example, the last two used menus are [NAV TOOL] and [AIS].

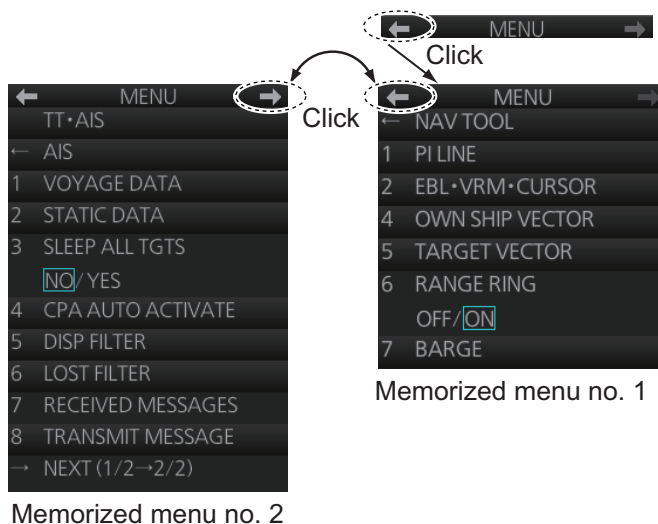

1.12.3 How to enter numeric data

Select the numeric data, then do one of the following:

Control Unit: Use the ten keys to enter data.

Trackball module: Spin the scrollwheel to set data then push the left button.

1.12.4 How to enter alphanumeric character data

Some operations display a software keyboard to enter alphanumeric character data.

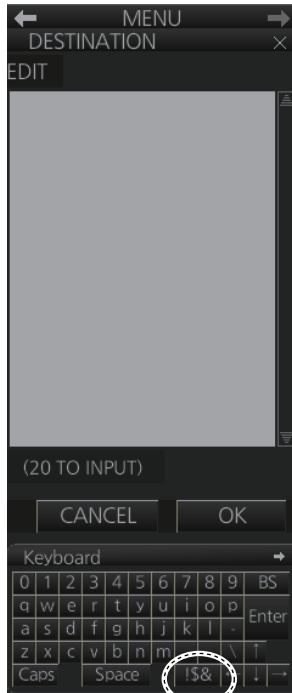

Click to switch between letters and symbols.

To enter characters, click applicable characters on the software keyboard. You can switch between letter input and symbol input by clicking the key circled in the illustration above.

1.13 Context-Sensitive Menus in the Radar Mode

Context-sensitive menus are available with many of the boxes and buttons surrounding the display area and objects within the display area. Right-click the boxes and buttons marked with numerals in the illustration below to show the related context-sensitive menus. If a menu is not operated within 30 seconds, it is automatically closed.

For context-sensitive menus in the chart mode, see the chapter on chart overview.

1.13.1 Context-sensitive menus available with buttons and boxes

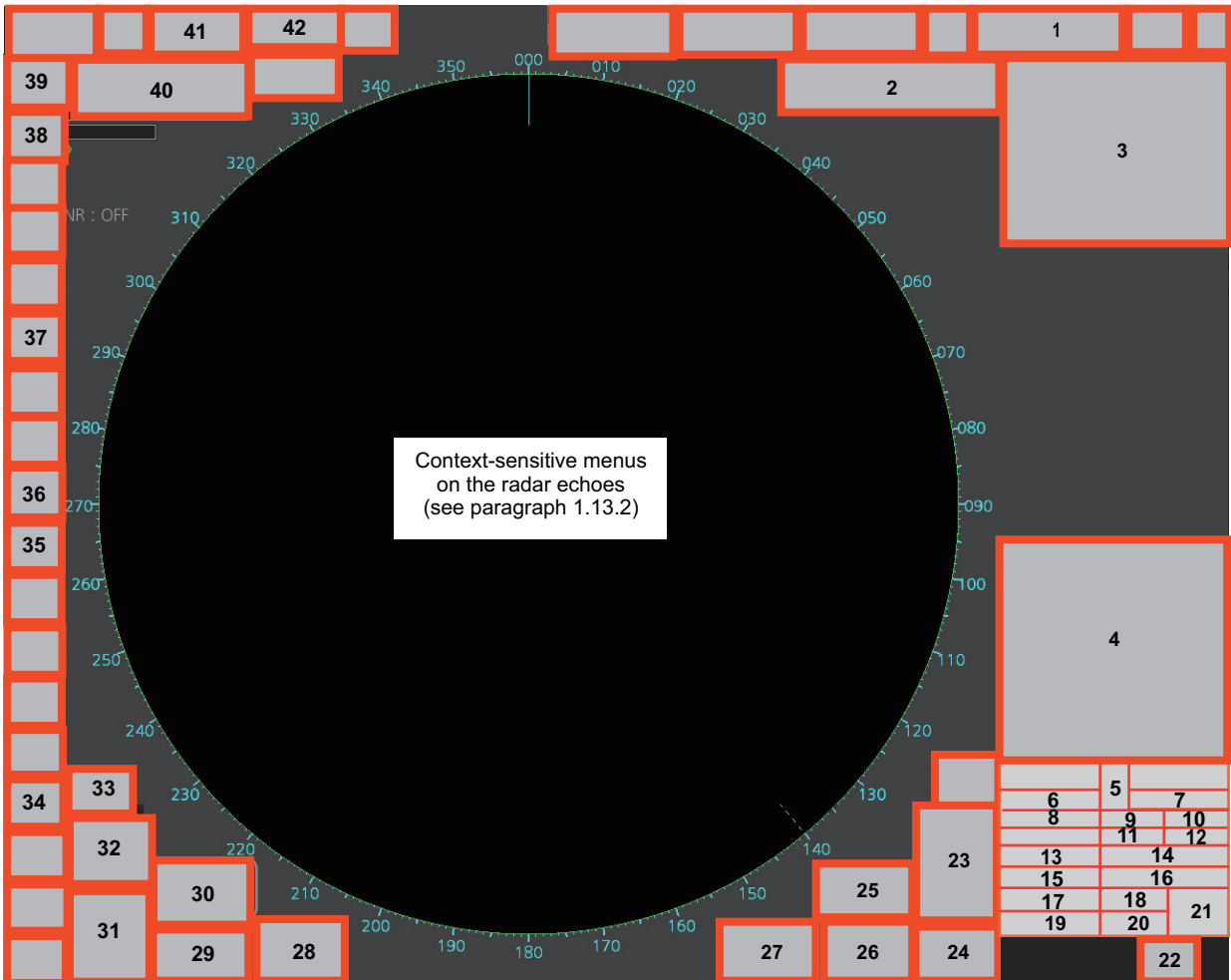

No.	Box name	Menu	No.	Box name	Menu
1	Adjust Local Time	Adjust Local Time	2	Cursor Position	Range-Bearing Position, X-Y Position, Cursor Menu
3	Sensor Information, Datum Box	Select Sensor, OS Info Menu	4	AIS Info	Expanded AIS Data, AIS Message
5	Association	Association OFF/TT/AIS, Association Menu	6	TT	OFF / MAN / AUTO / MAN/AUTO, TT Menu, Symbol Menu
7	AIS	DISP OFF / FILT / ALL, AIS Menu, Symbol Menu	8	Vector	OS Vector Menu, Target Vector Menu

1. OPERATIONAL OVERVIEW

No.	Box name	Menu	No.	Box name	Menu
9	Vector Time	Vector Time (30 s - 60 min), OS Vector Menu, Target Vector Menu	10	Vector Reference	True-G(S), REL, OS Vector Menu, Target Vector Menu
11	CPA Range	CPA Range (0.5 - 20 NM)	12	CPA time	CPA Time (1 - 60 min)
13	AIS CPA	Auto Activate Menu	14	Auto Activate	OFF, AUTO ACT FILT, AUTO ACT ALL, Auto Activate Menu
15	Lost TGT	TT Lost Filter Menu, AIS Lost Filter Menu	16	Lost TGT Filter	OFF, FILT, ALL, TT Lost Filter Menu, AIS Lost Filter Menu
17	Past POSN	Past POSN Menu	18	Past POSN display interval	Past POSN display interval (OFF, 30 s - 6 min), Past POSN Menu
19	Trail	Trail All Clear, Trail Menu	20	Trail Time	Trail Time (OFF, 15 s - 30 min, CONT), Trail Menu
21	Trail/Past POSN Reference	True-G(S), REL, Past POSN Menu, Trail Menu	22	Alert List	Alert List/Log Window
23	Trial	Trial Mode, Trial Maneuver Menu	24	AZ	Acquisition Zone Menu
25	Drop Mark 2	Drop2 Off	26	VRM 2	VRM2 Off, EBL•VRM Menu
27	VRM 1	VRM1 Off, EBL•VRM Menu	28	EBL 2	EBL2 Off, EBL•VRM Menu
29	EBL 1	EBL1 Off, EBL•VRM Menu	30	Drop Mark 1	Drop1 Off
31	Mark	Mark Color (B-type only), Mark Position, MAP File, Edit Map Comment, Map•Mark Menu	32	PI Line	Number of PI Line, Reset PI Line, PI Menu
33	Watch	Watch Time (OFF, 6 - 20 min)	34	Brill Menu	Brill Menu
35	Chart ON/OFF	Chart Display Menu	36	MAP ON/OFF	Radar Map Menu, Route Menu, Event Menu, User Chart Menu
37	ACE	Automatic Clutter Elimination (ACE) Menu	38*	TUNE	Tune Initialize
39	PULSE	Pulse Menu	40	RANGE	Range Scales 0.125 to 96.0 NM
41	Antenna Selection	Dual Radar, ANT Select Menu	42	Customize Echo	Customize Echo Menu

*: For solid state radar, this menu is not displayed.

1.13.2 Context-sensitive menus in the display area in the radar and chart radar modes

Right-click anywhere in the display area in the radar and chart radar modes to show the context-sensitive menu.



Radar Map On, Chart Off

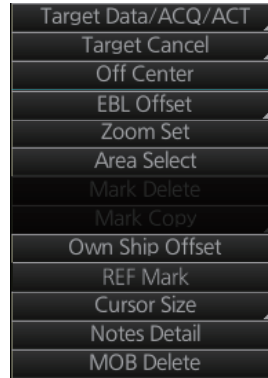

Radar Map Off, Chart Off

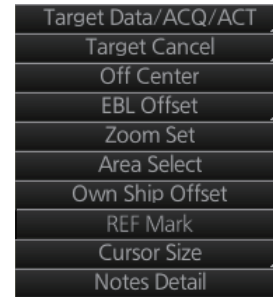

Radar Map Off, Chart On

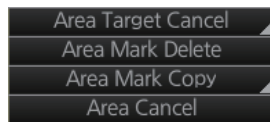

Radar Map On, Chart Off, area selected



Radar Map Off, Chart Off, area selected



Radar Map Off, Chart On, area selected

[Target Data/ACQ/ACT]: For cursor-selected TT or AIS target, display target data, acquire target for TT, or activate sleeping AIS target.

[Target Cancel]: Cancel tracking on selected tracked target (erase target), sleep activated AIS target.

[Off Center]: Off center the display.

[EBL Offset]: Offset EBL1, EBL2 (to measure range and bearing between two targets).

[Zoom Set]: Select zoom area.

[Area Select]: Specify the area where to delete, copy marks.

[Mark Delete]: Delete cursor-selected mark. Grayed out when radar map is off.

[Mark Copy]: Copy cursor-selected mark. Grayed out when radar map is off.

[Own Ship Offset]: Apply an offset to own ship position.

[REF Mark]: Make cursor-selected target a reference target (for use in TT). Grayed out unless TT is active.

[Cursor Size]: Select cursor size, large or small.

[Notes Detail]: Show details about cursor-selected Notes.

[MOB Delete]: Delete selected MOB mark.

Area selected

[Area Target Cancel]: Cancel tracking on targets within the area selected. The targets to cancel tracking can be selected as follows;

- [Any]: Cancel tracking of TT or AIS target; delete REF mark.
- [TT Only]: Cancel tracking of TT; delete REF mark.
- [AIS Only]: Cancel tracking of AIS target.

[Area Mark Delete]: Delete all marks within the area selected.

[Area Mark Copy]: Copy all marks within the area selected.

[Area Cancel]: Cancel the area created.

1.14 Cursor Position

Cursor data appears in the cursor position box at the top-right position on the display. The appearance of the box is slightly different between different size monitors, although the content is the same.

For the cursor position box that appears in the chart mode, see section 6.6.

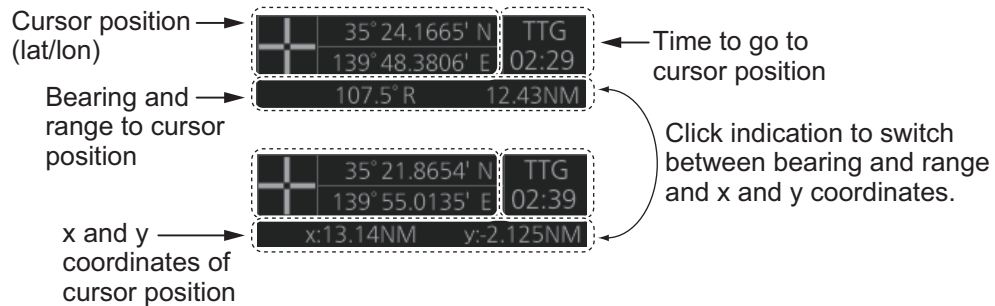

The indication below the cursor position can show the range and bearing to the cursor or x-y coordinates of the cursor position. Click that indication and select [Range-Bearing Position] or [X-Y Position] as appropriate. For the x-y coordinate display, the y-axis is the heading line, right/top is "plus" and left/lower is "minus".

Note 1: The cursor bearing can be selected to true or relative with [1 CURSOR BEARING] in the [CURSOR] menu. Right-click the indication and select [Cursor Menu] to open the [CURSOR] menu.

Note 2: The cursor position is shown as "----" when the cursor is not within the effective display area.

1.15 How to Select Sensor Settings

This radar system accepts navigation data input two ways: System or Local. System shares sensor data among multiple radars in a network. Sensor priority is also commonly shared among the radars. Local selects a sensor outside the network.

1. Right-click anywhere in the Sensor information, datum box to show the context-sensitive menu.
2. Click [Select Sensor].

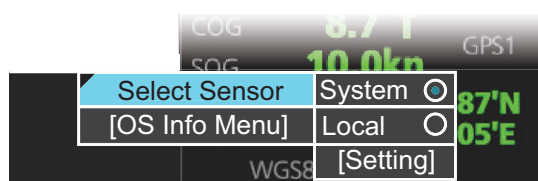

3. Click [System] or [Local].

Note: The sensor system can also be selected in the chart mode through this procedure and through the menu. Open the menu then select [7 OWN SHIP INFO] followed by [1 SENSOR].

1.16 How to Enter Ship Speed

The TT and azimuth stabilized presentation modes require own ship speed input and compass signal. The speed can be entered automatically from a speed log (STW, SOG) or GPS (SOG), or manually on the menu.

1. Right-click anywhere in the Sensor information, datum box to show the context-sensitive menu.
2. Click [Select Sensor] then click [Setting].

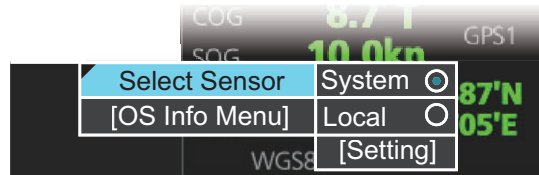

3. Use the arrow buttons to select the [SPD] page.

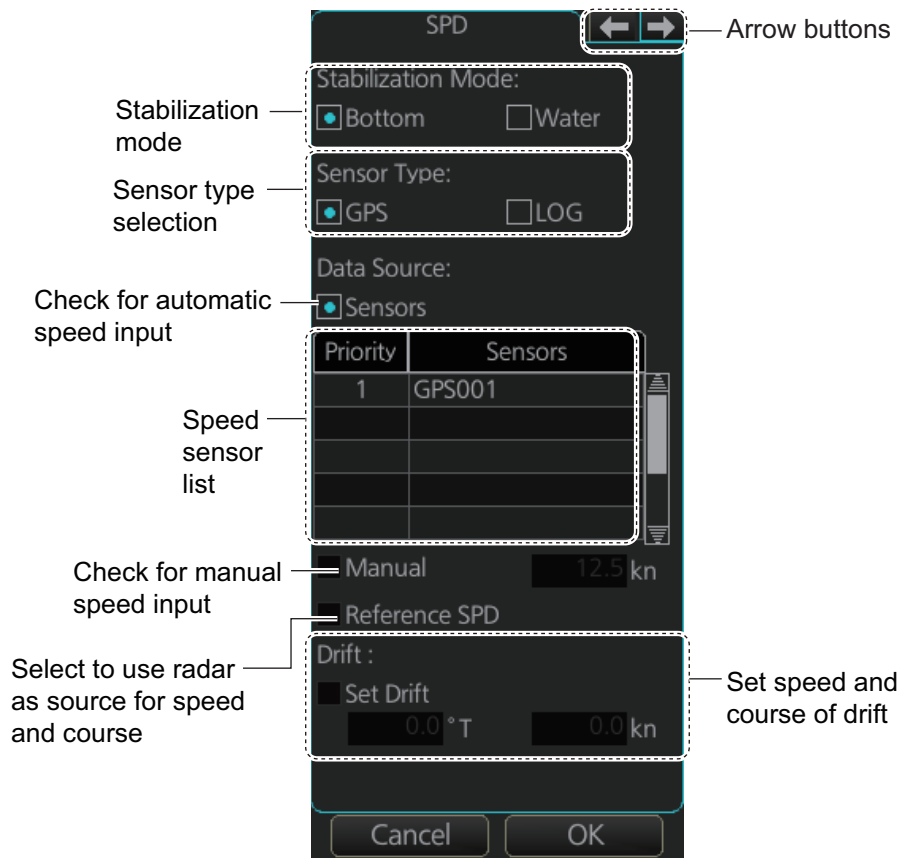

4. **For automatic input**, follow the procedure below. **For manual input**, go to step 5.
 - 1) Check [Sensors].
 - 2) Set the priority for the speed sensors in case of Local sensor. Click the triangle on any line then select the sensor to set as the primary source of speed. All other sensors are then set as secondary source. Only one sensor can be primary while the others can be secondary. If a speed sensor is changed from secondary to primary state and another speed sensor was selected as primary, then that sensor previously selected to primary state is then automatically selected to secondary state.
 - 3) Select [Bottom] or [Water] at [Stabilization Mode] to set the stabilization method. Select [Bottom] for GPS or [Water] for a speed log.

- 4) Check [GPS] or [LOG] at [Sensor Type] to select the source of speed data.
- 5) Go to step 6.
5. **For manual input**, set the stabilization mode for [Water] and check [Manual]. Click the manual box to show the up and down arrows. Click the arrows to set speed.
Note: For [Set Drift], see section 3.11.
6. Click the [OK] button to save the settings then click the [MENU] bar to close the menu.

Notes on speed input

- IMO Resolution A.823(19) for TT requires that a speed log to be interfaced with a TT should be capable of providing through-the-water speed (forward speed).
- A single-axis water log cannot measure speed when the wind is coming from the leeway direction.
- When AIS is active, [Manual], [Reference SPD] and [Set Drift] are shown in gray to indicate that they are not available for selection.

1.17 How to Enter Heading

Heading can be entered manually or automatically.

Note: When the vessel is in high latitudes (over 85°), data from the gyrocompass is not used. The internal filter data is used for heading calculation. In this case, the heading source in the sensor information box appears as "FILT". However, high latitudes are not supported in RADAR mode.

1. Right-click anywhere in the Sensor information, datum box to show the context-sensitive menu.
2. Click [Select Sensor] then click [Setting].
3. Use the arrow buttons to select the [HDG] page.

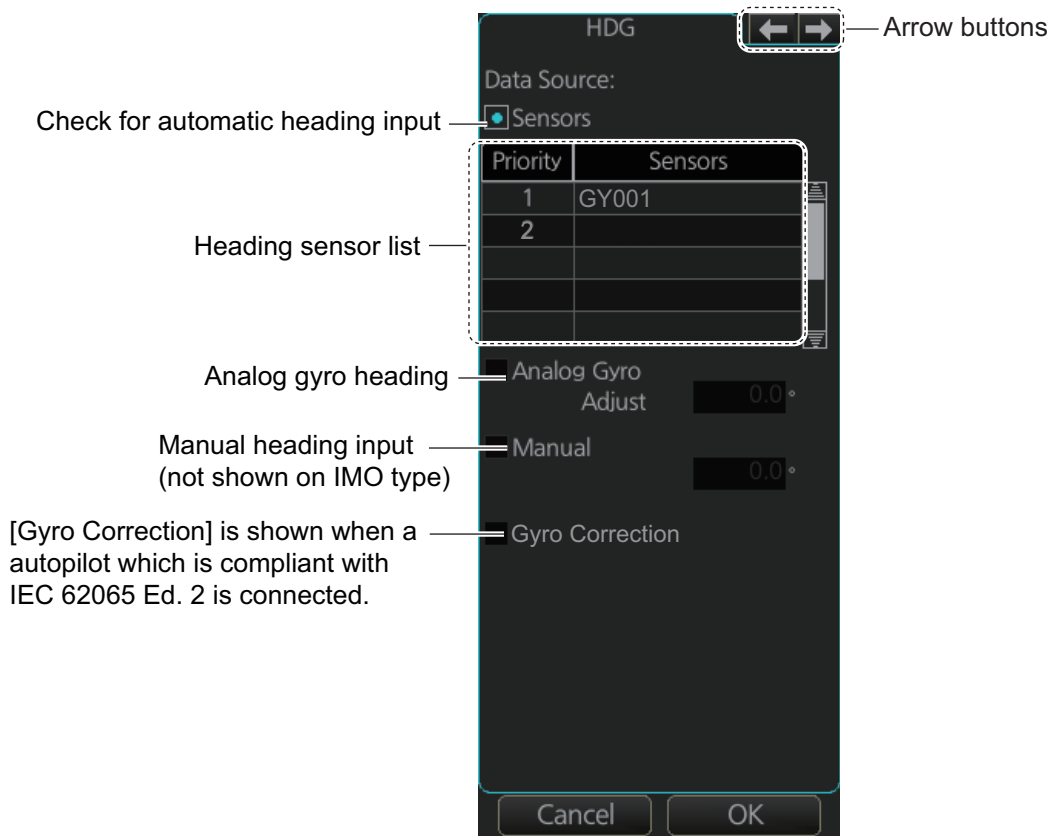

4. **For automatic input**, follow the procedure below. **For manual input**, go to step 5.
 - 1) Check [Sensors].
 - 2) Set the priority for the heading sensors. Click the triangle on any line then select the sensor to set as the primary source of heading. All other sensors are then set as secondary source. Only one sensor can be primary while the others can be secondary. If a heading sensor is changed from secondary to primary state and another heading sensor was selected as primary, then that sensor previously selected to primary state is then automatically selected to secondary state.
 - 3) Go to step 6.
5. **For manual input**, check the [Manual] box. Click the heading input box to show the up and down arrows. Click the arrows to set heading.
6. Click the [OK] button to save the settings then click the [MENU] bar to close the menu.

1.18 How to Mark MOB Position

Use the MOB (man overboard) feature to mark the position of man overboard on the display screen. Click the [MOB] button (in any mode) on the InstantAccess bar™.

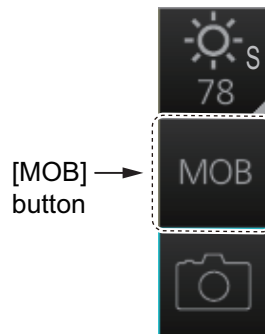

The MOB mark instantly appears at the geographical position of your ship when the button is clicked.



Up to 100 MOB marks can be saved. When the capacity for MOB marks is reached, the oldest mark is automatically erased to make room for the latest.

To hide an MOB mark, get into the Navigation voyage mode ([NAVI]) or Voyage planning mode ([PLAN]), right-click the mark to show the context-sensitive menu then select [Hide MOB].

Exercise caution when using this feature in strong tide or current. The person will not be at the MOB position for a very long time.

How to find MOB information

In Navigation voyage mode or Voyage planning mode, put the cursor on a MOB mark and click. Text can be entered in the [MOB Description] window. Click the [OK] button to save the text and close the window.

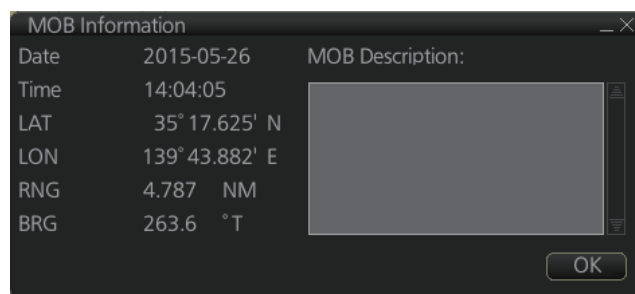

1.19 How to Offset Position

The position shown in the Sensor information, datum box (section 1.11) may be different from the actual position. This error affects the positioning accuracy of radar echoes, radar map and TT and AIS symbols. If there is a difference, apply an offset to position as shown below to compensate for the error.

1. Right-click the display area to show the context-sensitive menu.
2. Select [Own Ship Offset] and push the left button. The color of the cursor becomes blue.
3. Roll the trackball until the cursor is at the "correct position".
4. Push the left button to confirm.

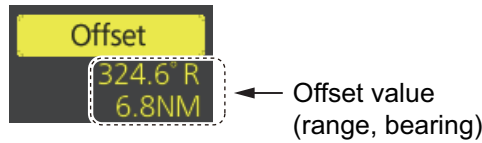

To cancel the offset, show the context-sensitive menu then select [Reset Own Ship Offset]. The indication [Offset] and the offset values are then erased from the display.

1.20 How to Select Time Format, Set Local Time

The time indication on the Status bar shows either UTC time and date, or on-board time and date, and cannot be adjusted. On-board time display requires synchronization with the on-board clock. For further details, consult your local dealer.

You can switch between the local time and the UTC time by left-clicking the Current time format indication (requires synchronization with local time, consult your local dealer for details).



Note: If the ZDA sentence is not input to this system, the date and time indications on the status bar appear in yellow color.

To use the local time, enter the time difference between the local time and the UTC time as shown below.

Note: Where the on-board time is synchronized, the local time setting is not available.

1. Right-click the Current time format indication to show the context-sensitive menu.
2. Click [Adjust Local Time] to display the [Local Time Adjust] dialog box.
3. Enter the time difference between the local time and the UTC time, in hours and minutes. Use the button on the left to select the time offset direction. Select "+" if the local time is ahead of the UTC time, or "-" if it is behind the UTC time.
4. When input is complete, click [OK] to apply the changes.

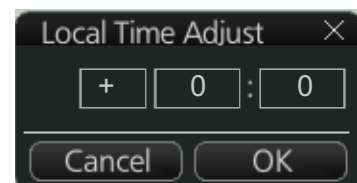

1.21 How to Take a Screenshot of the Display

Click the [Capture] button on the InstantAccess bar™ to take a screenshot and save it to the SSD (Solid State Drive). You can save a maximum of 100 screenshots. When the capacity for screenshots is reached, the oldest screenshot is automatically deleted to make room for the latest. You cannot take a screenshot when a menu or a dialog box is opened.

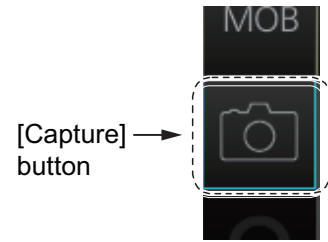

Screenshots can be copied to a USB flash memory. For how to process screenshots, see section 22.10.

1.22 The Settings Menu

The [Settings] button gives you access to the user profiles and the [Settings] menu. The [Settings] menu has facilities for screenshot management, file management, diagnostic tests and customizing. See chapter 22.



1.23 User Profiles for Radar, Chart Radar

The [Settings] button lets you store ten sets of custom settings and color settings (echoes, TT and AIS symbols and echo trails). This allows individual users to quickly set the system according to their preferences.

1.23.1 How to create a profile

1. Set the settings (echoes, TT and AIS symbols, echo trail, etc.) as desired.
2. Click [- 3. Select a profile number from the "Profile" drop-down list.

Note: Profiles 06-10 are disabled in the default setting. To enable a disabled profile, select the profile to enable from the "Profile" drop-down list then uncheck [Disable this profile].
- 4. Click [Save Current Settings].

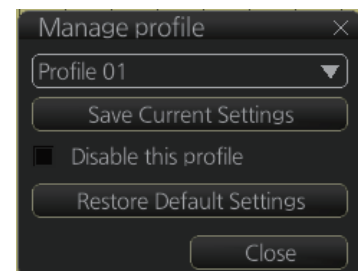

1.23.2 How to disable a profile

1. Click [- 2. Select a profile number from the "Profile" drop-down list.
- 3. Check [Disable this profile].

The profile enabled at section 1.23.3 cannot be disabled.

1.23.3 How to activate a profile

1. Click [⚙️] on the Status bar.
2. Click the profile number to activate. The confirmation message "Attention: Settings will be changed to Profile XX. Do you wish to continue?" appears.
3. Click [Yes].

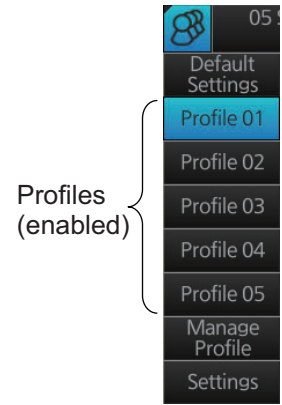

1.23.4 How to restore a profile to the default settings

1. Click [⚙️] on the Status bar then click [Manage Profile].
2. Select a profile number from the [Profile] drop-down list.
3. Click [Clear Profile]. The confirmation message "Attention: This profile will be restored to the default. Do you wish to continue?" appears.
4. Click [Yes].

1.23.5 How to change the settings on the current display to the recommended settings

1. Click [⚙️] on the Status bar.
2. Click [Default Settings]. The confirmation message "Attention: Settings will be changed to the default. Do you wish to continue?" appears.
3. Click [Yes]. The settings on the following table are changed to the recommended settings.

Note: This function is not available when using the interswitch function (see section 2.29).

Radar Mode

Items	Settings
RAIN, SEA	AUTO
GAIN	80
EAV	No change
Automatic Clutter Elimination (ACE)	OFF
TUNE (other than solid state radar)	TUNE AUTO
TX CH (for solid state radar)	No change
RANGE	6 NM, 6 SM, 6 km, 6 kyd
VRM1	0.25 NM, 0.25 SM, 0.25 km, 0.25 kyd
VRM2	OFF (No change)
EBL1	ON (No change)
EBL2	OFF (No change)
Presentation mode	North-up TM Note: Head-up RM with no heading or position data.
Off Center	The ship's position is put beyond 75% of the range scale.
Trail	Trail time: 6 min, Trail mode: True-G
Past POSN	OFF
Lost TGT	OFF

Items	Settings
TT ACQ	No change Note: TT OFF with no heading data.
Vector	Vector time: 6 min, Vector reference: REL
AZ1, AZ2 (acquisition zone)	OFF
AIS	DISP ALL Note: FUNC OFF with no heading or position data.
Association	TT (>)
CPA/TCPA	CPA: 2 NM, TCPA: 12 min
AUTO ACQ	AUTO ACQ OFF
Nautical chart ON/OFF button	Chart OFF
MAP (Radar map)	No change
Route	No change
Alert	AZ1/AZ2: OFF, Lost TGT: OFF
Antenna connection status	No change
RANGE RING	OFF
PI LINE	PI1 to PI6: OFF Number of PI line, mode, bearing range truncate: No change
SPD (Own Ship Sensor Setting)	Stabilization Mode: Bottom* Sensor Type: GPS* Sensor Setting: No change (System or Local)

*: These settings can not be applied, the settings are changed according to the priority order of SPD.

Chart for Radar mode

Item	Settings	
[Route Information] menu		
Route information page	unit of "XTD" m	
[System Sensor Settings]/[Local Sensor Settings] menu		
SPD page	Stabilization Mode Bottom	
[Other Sensor Settings] menu		
Other Sensor page	Wind m/s	
[Basic Setting] menu		
Basic Setting page	TM Reset 90%	
[Chart Display] menu		
General page	Symbols	Paper Chart
	Boundaries	Plain
	Four Shades	Unchecked
	Full Light Lines	Unchecked
	Scale MIN	Unchecked
	Shallow Pattern	Unchecked
	Shallow Water Dangers	Checked
	Unknown	Checked
	Accuracy	Unchecked
	Highlight Date Dependent	Unchecked
	Highlight INFO	Unchecked
	Highlight Document	Unchecked

1. OPERATIONAL OVERVIEW

Item		Settings
General page	Contour Labels	Unchecked
	LAT/LON Grid	Unchecked
Text page	Important Text	Checked
NtoM page	Temporary Notices	Unchecked
	Preliminary Notices	Unchecked
	No Information	Unchecked
[Symbol Display] menu		
General page	Ship Outlines	OFF
	AIS Outlines	OFF (grayed out)
Tracking page	CCRP	Checked
	Primary	Checked
	Secondary	Checked
	Pivot	Checked
	Length	720 min
	Labels	30 min
Mariner page	Labels	Checked
	Lines	Checked
	Clearing Lines	Checked
	Tidals	Checked
	Areas	Checked
	Circles	Checked
[Chart Alert] menu		
Chart Alert page	Safety Contour	Keeps previous setting
	Safety Depth	Keeps previous setting
	Safety Contour check box	Checked
	Dangerous or special areas *1	Checked
	Navigational Hazard check box	Checked
	Navigation Hazard Alert level	C (Caution)
[TT/AIS]-[Setting] menu		
Setting.1 page	Sleeping Class A *2	OFF
	Sleeping Class B *2	OFF
	Physical AtoN	ON
	Virtual AtoN	ON
	MAX Range	ON, 6 NM
Chart scale/presentation mode box		
Chart scale	3 NM	
Presentation mode	North Up TM	
[Overlay/NAV Tools] box		
Look-ahead page	Ahead	Time, 6 min
Echo page *3	Display	OFF
TT/AIS page	TT display	OFF
	AIS display	DISP ALL
	Vector	6 min, REL
	Past POSN	OFF
Other functions		
Brilliance	CALIB	
Viewing Date - Display Date	Auto: Today	

Item	Settings
Split Screen	Full Screen (no split)
Chart database mode	CUSTOM
TM Reset function	Enabled
Own track	Disabled
Log - NAV Log - Detail dialog	Show Track

*1: Chart alert objects other than the following:

- Safety Contour
- Navigational Hazard
- No Vector Chart
- UKC Limit
- Sounding UKC Limit
- Non-official ENC
- Not up-to-date
- Permit Expired

*2: Not shown on A- or IMO-type specification.

*3: Available only when the [Echo] page is enabled at installation.

1.24 How to View Chart Software Version No., Chart System Information, and Operator's Manual

You can show chart program no., chart system information, and the operator's manual as follows:

1. Click the Display mode button at the left end of the Status bar to select [CHART for RADAR].
2. Click the [?] button on the Status bar.

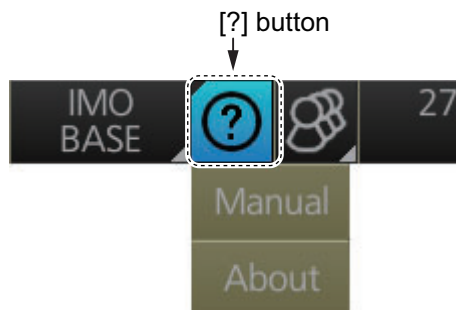

3. Select [Manual] to show the operator's manual, or [About] to show chart and system information.

On the [About] screen, click the [Version] tab to show the chart software version no., conning software version no., S52 presentation library version, ENC user permit no., and C-MAP SDK software version no. Click the [System 1] tab to show system information: CPU type, RAM capacity, SSD free/SSD capacity, Equipment ID and dongle information. [Function] shows this unit's capabilities. Click the [System 2] tab to show the startup time for this equipment.

1. OPERATIONAL OVERVIEW

The information shown in the following illustration may be different from those on your system.

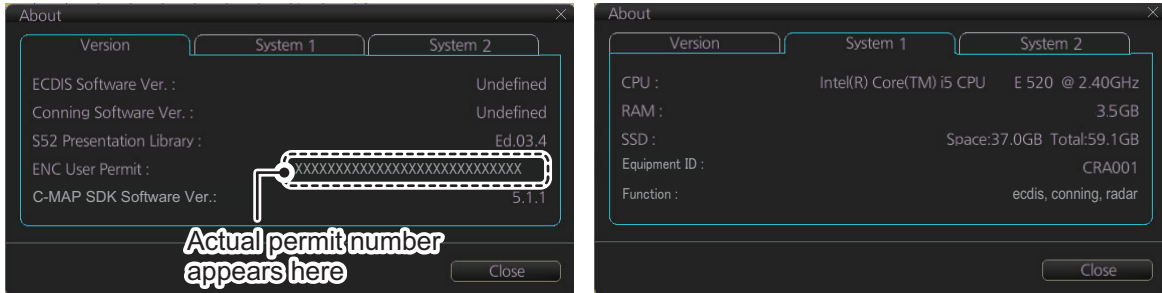

[Version] tab

[System 1] tab

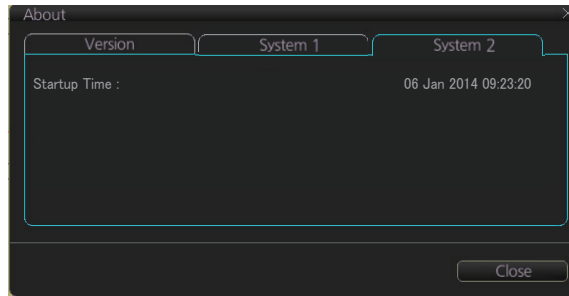

[System 2] tab

1.25 Tips (operational guidance)

This chart radar provides operational tips for the display area, InstantAccess bar™ and Mark box. To get a tip, simply put the cursor on the object. For example, put the cursor on the [BRILL] button on the InstantAccess bar™. The tip "Adjust brilliance" appears.



If you do not need the tips, you can turn them off with [TIPS GUIDANCE] in the [INITIAL SETTING] menu.

1.26 Printer Information

A Hewlett Packard (HP) printer may be connected to the system to print ENC Publisher's Notes, reports, logs, etc.

The available HP printers are Officejet Pro 8000, Officejet Pro 8100, Officejet Pro 8210, Officejet 100 Mobile and Officejet 200 Mobile. No other makes or models are permitted.

2. RADAR, CHART RADAR OPERATION

2.1 How to Transmit

After the power is turned on and the magnetron has warmed*, "STBY" appears at the screen center, meaning the radar is ready to transmit radar pulses. You can transmit by pushing the **STBY TX** key on the Control Unit, or clicking the [STBY TX] button on the Status bar.

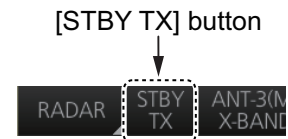

*: The solid state radar does not have a magnetron, therefore it has no warming period.

The radar is initially set to previously used range and pulse length. Other settings such as brilliance levels, VRMs, EBLs and menu option selections are also set to previous settings.

The **STBY TX** key (or [STBY TX] button) toggles the radar between STBY and TRANSMIT state. The antenna is stopped in stand-by and rotates in transmit. Set the radar in standby when its use is not required, to conserve the life of the magnetron.

When the antenna stops, it faces the bow. However, wind and other factors may cause the antenna to move slightly.

2.2 How to Tune the Radar Receiver

After the radar is transmitting, adjust the receiver to the exact frequency of the transmitter.

2.2.1 Tuning for magnetron radar

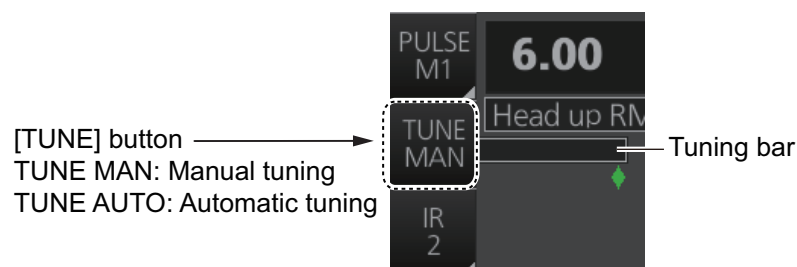

How to initialize tuning

Automatic tuning is initialized during the installation. However, if you feel that automatic tuning is not working properly try re-initializing the tuning. Right-click the [TUNE] button then select [Tune Initialize] to start the initialization. The indication [Tune INI] appears during initialization.

Automatic tuning

Click the [TUNE] button on the InstantAccess bar™ to display [TUNE AUTO].

Manual tuning

To tune the radar, start by setting the brilliance to a comfortable level, adjusting the gain until the background speckle just disappears, and selecting the 48 NM range. Then, do the following:

1. Select a weak contact somewhere near the edge of the screen and concentrate on that, while adjusting the gain control in small steps - allowing at least two seconds between each step - until the chosen contact is as big, bright and consistent as possible.
2. Click the [TUNE] button on the InstantAccess bar™ to display [TUNE MAN].
3. Put the cursor on the tuning bar.
4. Spin the scrollwheel to tune. The best tuning point is where the bar swings maximum. The arrow below the bar shows the tuning control position; not the tuning condition.

2.3 Pulse Length

The pulse length in use is displayed at the top-left position on the screen, using the indications shown in the table below.

Pulse length indication	Pulse length (µs)	
	Magnetron radar	Solid state radar (P0N/Q0N)
S1	0.07	0.07/5.0
S2	0.15	0.18/7.5
M1	0.3	0.3/12.5
M2	0.5	0.5/17.5
M3	0.7	0.7/18.3
L	1.2	1.2/18.3

Appropriate pulse lengths are preset to individual range scales and function keys. If you are not satisfied with the current pulse length settings, you can change them as shown below.

2.3.1 How to select a pulse length

You can select the pulse length for the 0.5 to 24 NM range scales as shown below.

1. Open the menu then select [1 ECHO], [1 CUSTOMIZE ECHO] and [8 PULSE] menus to show the [PULSE] menu.
2. Do one of the following:
Control Unit: Press appropriate numeric key to select corresponding item number.
Trackball module: Click appropriate item.
3. Select desired option by pressing the numeric key pressed at step 2 or spinning the scrollwheel.
4. To confirm selection, press the **ENTER** key on the Control Unit, or push the left button.

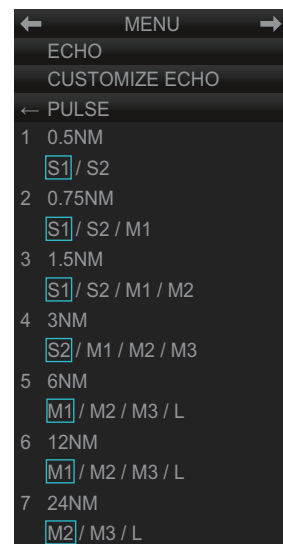

2.3.2 How to change the pulse length

1. Click the [Pulse] button at the top of the InstantAccess bar™.
2. Click a pulse length.

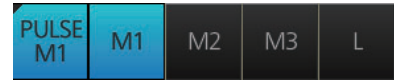

2.4 How to Adjust the Sensitivity

The **GAIN** control (or [Gain] button) adjusts the sensitivity of the receiver. The proper setting is such that the background noise is just visible on the screen. If you set up for too little sensitivity, weak echoes may be missed. On the other hand excessive sensitivity yields too much background noise; strong targets may be missed because of the poor contrast between desired echoes and the background noise on the screen.

Adjust the gain so background noise is just visible on the screen.

Note: For adjustment of gain when the Automatic Clutter Elimination (ACE) function is ON, see subsection 2.10.2.

To adjust the sensitivity, do one of the following:

Control Unit: While monitoring the radar image and the gain slider bar, operate the **GAIN** control to adjust the sensitivity.

Trackball module: For coarse adjustment, put the cursor within the slider bar area then push the left button. For fine adjustment, put the cursor at the end of the slider bar then roll the trackball while pushing and holding down the left button. Release the button to finish.

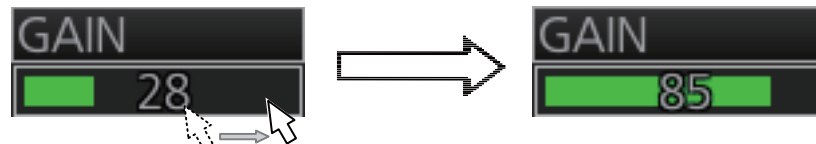

Put cursor on slider bar and push and hold left button.
Drag cursor to new location then release left button.

2.5 How to Suppress Sea Clutter

Echoes from waves cover the central part of the display with random signals known as sea clutter. The higher the waves, and the higher the antenna above the water, the further the clutter will extend. When sea clutter masks the picture, suppress it with the **A/C SEA** control (or [SEA] on the Status bar), either manually or automatically.

When both sea clutter and rain clutter are reduced, the sensitivity is decreased more than when only one is adjusted. For that reason adjust them carefully.

The echo average (see section 2.9) is useful for reducing reflections from the sea surface. However, high-speed targets are harder to detect than stationary ones when the echo average is active.

2.5.1 How to reduce sea clutter automatically

Auto A/C SEA allows for fine-tuning of the A/C SEA circuit, within ± 20 dB. Lower the auto A/C SEA level because the average value of the original input echo is low in areas where there are no sea surface reflections. For example, when the ship is alongside a quay and the radar picture shows echoes from both land and sea, you can observe the size of echoes because the STC curve is different depending size of echoes.

To get automatic adjustment of sea clutter, do one of the following:

Control Unit: Push the **A/C SEA** control to display [AU-TO] on the SEA mode indication on the Status bar.

Trackball module: Click the SEA mode indication on the Status bar to display [AUTO].

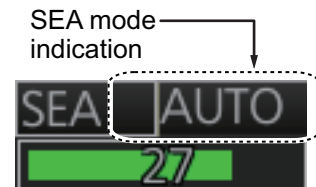

2.5.2 How to reduce sea clutter manually

The **A/C SEA** control reduces the amplification of echoes at short ranges (where clutter is the greatest) and progressively increases amplification as the range increases, so amplification will be normal at those ranges where there is no sea clutter.

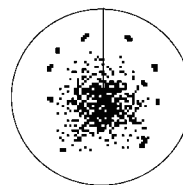

Sea clutter at screen center

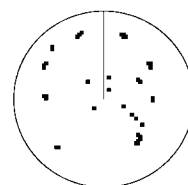

A/C SEA adjusted; sea clutter suppressed

The proper setting of the A/C SEA should be such that the clutter is broken up into small dots, and small targets become distinguishable. If the setting is set too low, targets will be hidden in the clutter, while if the setting is too high, both sea clutter and targets will disappear from the display. In most cases adjust the control until clutter has disappeared to leeward, but a little is still visible windward.

Be careful not to remove all sea clutter, because you may erase weak echoes. Further, the possibility of losing weak echoes is greater when you use both A/C SEA and A/C RAIN to reduce clutter.

To reduce sea clutter manually, do one of the following:

Control Unit: Push the **A/C SEA** control to display [MAN] on the SEA mode indication on the Status bar. Rotate the **A/C SEA** control to adjust the sea clutter.

Trackball module: Click the SEA mode indication on the Status bar to display [MAN]. For coarse adjustment, put the cursor within the slider bar area then push the left button. For fine adjustment, put the cursor at the end of the slider bar then roll the trackball while pushing and holding down the left button. Release the button to finish.

2.5.3 How to use the BERTHING STC function

The [BERTHING STC] function allows you to show the main bang echo, even with the range set at 0.5 NM or less with AUTO SEA at maximum setting. This is particularly useful when attempting to berth, as it gives a clearer view of the berthing area and your ship's location.

To use the [BERTHING STC] function, follow the procedure below.

1. Open the menu then select [1 ECHO], [0 NEXT] to show the second page of the [ECHO] menu.
2. Select [1 BERTHING STC].
3. Select [OFF] or [ON] as appropriate.
4. Close the menu

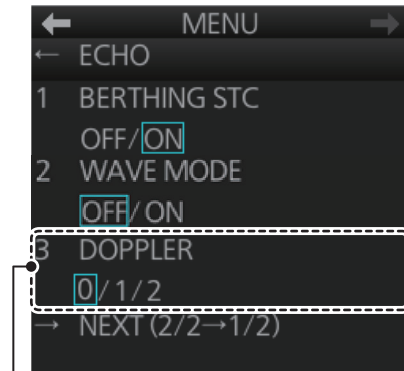

Shown only for FAR-3220-NXT,
FAR-3220-NXT-BB and FAR-3320-NXT.

2.6 How to Suppress Rain Clutter

The vertical beam width of the antenna is designed to see surface targets even when the ship is rolling. However, by this design the unit will also detect rain clutter (rain, snow, or hail) in the same manner as normal targets.

The **A/C RAIN** control adjusts the receiver sensitivity as the **A/C SEA** control does but rather in a longer time period (longer range). The higher the setting, the greater the anti-clutter effect. When echoes from precipitation mask solid targets, adjust the **A/C RAIN** control to split up these unwanted echoes into a speckled pattern, making recognition of solid targets easier.

Be careful not to remove all rain clutter, because you can erase weak echoes. Further, the possibility of losing weak echoes is greater when you use both A/C RAIN and A/C SEA to reduce clutter.

When both sea clutter and rain clutter are reduced the sensitivity is decreased more than when only one is adjusted. For that reason adjust them carefully.

The echo average (see section 2.9) is useful for reducing reflections from the sea surface. However, high-speed targets are harder to detect than stationary ones when the echo average is active.

2.6.1 How to reduce rain clutter automatically

Control Unit: Push the **A/C RAIN** control to display [AUTO] on the RAIN mode indication on the Status bar.

Trackball module: Click the RAIN mode indication on the Status bar to display [AUTO].

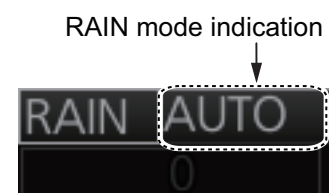

2.6.2 How to reduce rain clutter manually

Control Unit: Push the **A/C RAIN** control to display [MAN] on the RAIN mode indication on the Status bar. While watching the radar picture, adjust the **A/C RAIN** control to reduce the clutter.

Trackball module: Click the RAIN mode indication on the Status bar to show [MAN]. For coarse adjustment, put the cursor within the slider bar area then push the left button. For fine adjustment, put the cursor at the end of the slider bar then roll the trackball while pushing and holding down the left button. Release the button to finish.

Note: The detection range is reduced when the RAIN is used to show targets in rain. Generally, the amount of rain, TX pulse length and TX frequency are factors in determining how the detection range is affected. The figures shown below illustrate this occurrence.

How to interpret the graph

Using the X-band graph as an example, a radar target originally detected on the 8 NM range can only be detected in rain at ranges shown below:

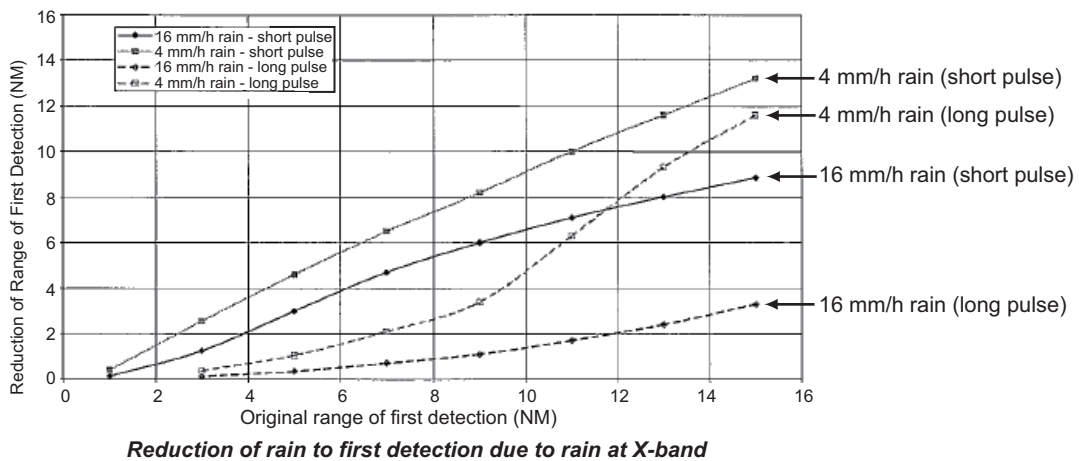
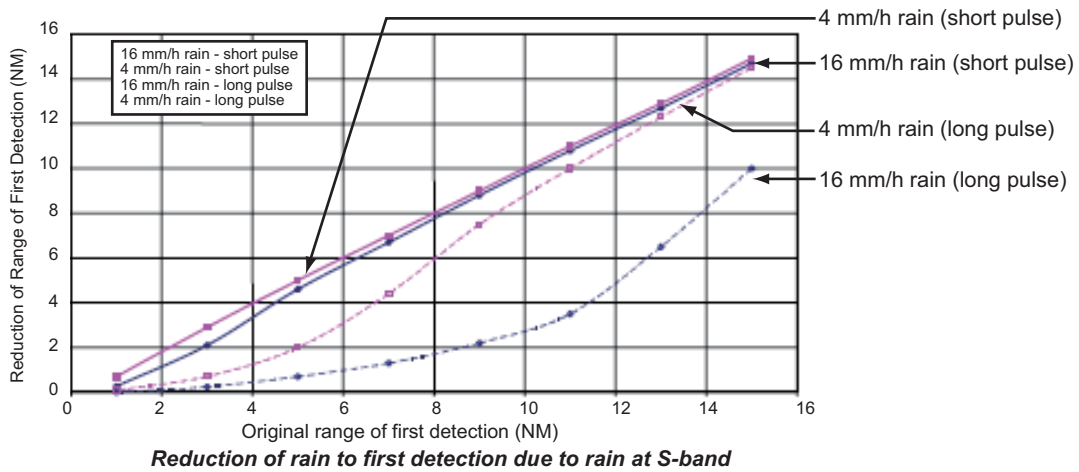

The author thanks the International Electrotechnical Commission (IEC) for permission to reproduce Information from its Interantional Standard IEC 62388 ed.1.0 (2007). All such extracts are copyright of IEC, Geneva, Switzerland. All rights reserved. Further information on the IEC is available from www.iec.ch. IEC has no responsibility for the placement and context in which the extracts and contents are reproduced by the author, or is IC in any way responsible for the other content or accuracy therein.

Accordingly the short pulse may be preferable in rain on ranges < 10NM.

2.7 Interference Rejector

Mutual radar interference may occur in the vicinity of another shipborne radar operating in the same frequency band. It is seen on the screen as a number of bright spikes either in irregular patterns or in the form of usually curved spoke-like dotted lines extending from the center to the edge of the picture. Activating the interference rejector circuit can reduce this type of interference.

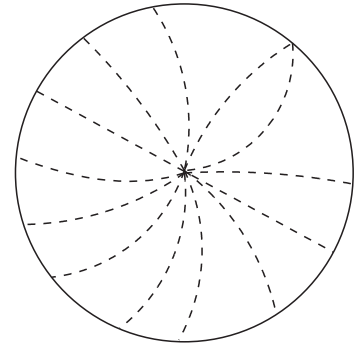

The interference rejector is a kind of signal correlation circuit. It compares the received signals over successive transmissions and reduces randomly occurring signals.

There are three levels of interference rejection depending on the number of transmissions that are correlated.

Click the [IR] button on the InstantAccess bar™ then click desired rejection level. The higher the number the greater the degree of interference rejection.



For solid state radar: When there is a lot of interference, switch the [TX CH]. Click the [TX CH] button on the InstantAccess bar™ then click [1] or [2].

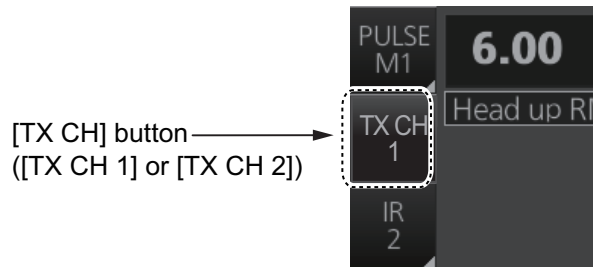

Note: When multiple radars using the same frequency are nearby, interference may appear in a similar manner to that shown in the figure to the right. If this kind of interference appears, press the **HL OFF** key, or click the [HL OFF] button on the InstantAccess bar™.

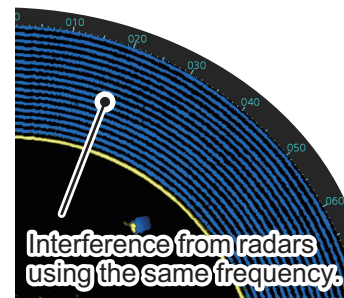

2.8 Echo Stretch

The echo stretch feature enlarges targets in the range and bearing directions to make them easier to see, and it is available on any range. There are three levels of echo stretch, 1, 2 and 3. The higher the number the greater the amount of stretching.

The echo stretch magnifies not only small target pips but also returns from the sea surface, rain and radar interference. For this reason, suppress those types of interference before activating the echo stretch.

Click the [ES] button on the InstantAccess bar™ then click desired echo stretch level.



2.9 Echo Averaging

The echo averaging feature, which requires heading, position and speed data, effectively reduces sea clutter. Echoes received from stable targets such as ships appear on the screen at almost the same position every rotation of the antenna. On the other hand, unstable echoes such as sea clutter appear at random positions.

To distinguish real target echoes from sea clutter, echoes are averaged over successive picture frames. If an echo is solid and stable over successive frames, it is presented in its normal intensity. Sea clutter is averaged over successive scans and its brilliance reduced, making it easier to discriminate real targets from sea clutter.

Echo averaging uses scan-to-scan signal correlation technique based on the true motion over the ground of each target. Thus, small stationary targets such as buoys will be shown while reducing random echoes such as sea clutter. True echo averaging is not however effective for picking up small targets running at high speeds over the ground.

Note 1: With echo average active it is harder to detect high-speed targets than stationary ones.

Note 2: Do not use echo averaging under heavy pitching and rolling; loss of targets can result.

Note 3: When the heading sensor signal is lost, [EAV] is turned OFF and the indication is grayed out.

Before using the echo averaging function, reduce sea clutter with the **A/C SEA** control. Leave a little sea clutter on the screen so as not to erase weak targets. Then, do as follows:

Click the [EAV] button on the InstantAccess bar™ then click desired setting.



OFF: Echo averaging is OFF.

1, 2: Detects targets hidden in sea clutter. "2" is more effective than "1" in detecting targets hidden in strong sea clutter. However, "1" is more effective than "2" in displaying high-speed targets. Select the setting best suited to your objective.

3: Stably displays unstable targets; distinguishes high-speed craft from sea clutter.

When the Automatic Clutter Elimination (ACE) function is ON (see section 2.10), the indication for the EAV button is grayed out.

Note: When [PERFORMANCE MON] (see section 2.31) or [SART] (see section 2.36) is ON, [EAV] is OFF and the indication is grayed out.

2.10 Automatic Clutter Elimination (ACE) Function

This radar has the Automatic Clutter Elimination (ACE) function. This function detects sea and rain clutter from received echoes' range and bearing trend and automatically reduces sea and rain clutter according to the Automatic Clutter Elimination (ACE) threshold setting.

Note: Use this function with caution. Weak target echoes may disappear from the screen.

2.10.1 How to turn the Automatic Clutter Elimination (ACE) function on/off

Click the [ACE] button on the InstantAccess bar™ to turn the Automatic Clutter Elimination (ACE) function on or off. When the Automatic Clutter Elimination (ACE) function is [ON], the indications for [RAIN] and [SEA] on the Status bar are grayed out.



Note: When [PERFORMANCE MON] (see section 2.31) or [SART] (see section 2.36) is ON, [ACE] is OFF and the indication is grayed out.

2.10.2 How to adjust the gain in the Automatic Clutter Elimination (ACE) mode

Control Unit: Rotate the **GAIN** control to adjust the sensitivity.

Trackball module: For coarse adjustment, put the cursor within the slider bar area on the Status bar then push the left button. For fine adjustment, put the cursor at the end of the slider bar then roll the trackball while pushing and holding down the left button. Release the button to finish.

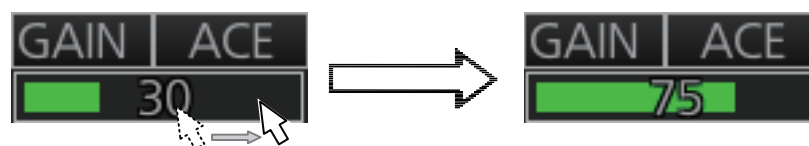

Put cursor on slider bar and push and hold left button.
Drag cursor to new location then release left button.

2.10.3 Automatic Clutter Elimination (ACE) menu

Open the menu then select the [1 ECHO] and [0 ACE] menus to show the [ACE] menu.

- [1 ADJUST]: No use.
- [2 SIGNAL ENHANCEMENT]: Set the level for the high sensitivity mode (see subsection 2.10.4).
- [3 SUPPRESS SECTOR]: Set the angular range for suppression of false echoes (see subsection 2.10.5).

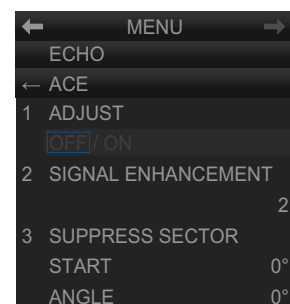

2.10.4 How to get the high sensitivity

When Automatic Clutter Elimination (ACE) function is [ON], the high sensitivity mode operates while pushing the **GAIN** control. You can select the level for the high sensitivity mode as follows:

1. Open the menu then select [1 ECHO].
2. Select [0 ACE] and [2 SIGNAL ENHANCEMENT].
3. Select the level from [1], [2] or [3].
4. Close the menu.

2.10.5 How to suppress the false echoes

The echo signals can appear on the screen at positions where there is no target or disappear when there are targets (see subsection 2.44.2). You can suppress the false echoes.

1. Open the menu then select [1 ECHO].
2. Select [0 ACE] and [3 SUPPRESS SECTOR].
3. Select [START] then set the start angle from which you want to suppress the false echoes.
4. Select [ANGLE] then set the angle range to which you want to suppress the false echoes.
5. Close the menu.

2.11 Noise Rejector

White noise may show itself on the screen as random "speckles" spread over the entire radar image. This equipment reduces the white noise then improves the on-screen S/N ratio by processing the weighted moving average filter for the received echoes in the range direction.

Note: Use this function with caution. Weak target echoes may disappear from the screen or the range resolution may worsen.

You can remove this noise as follows:

1. Open the menu then select [1 ECHO].
2. Select [1 CUSTOMIZE ECHO] menus to show the [CUSTOMIZE ECHO] menu.
3. Select [4 NOISE REJECT].
4. Select [OFF] or [ON] as appropriate.
5. Close the menu.

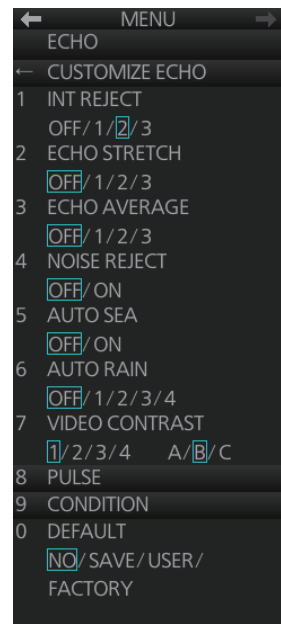

The status of the noise rejector is indicated at the top-left position, [NR: ON] or [NR: OFF].



Noise Rejector ON

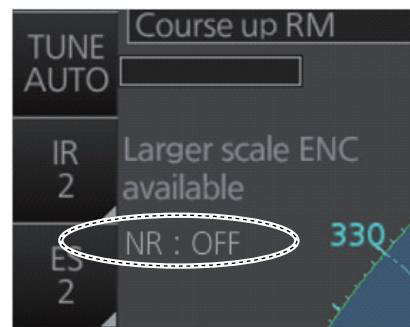

Noise Rejector OFF

2.12 Wiper

The wiper feature automatically reduces the brilliance of unwanted weak echoes, such as noise, sea clutter and rain clutter, to clear the picture. There are two wiper settings, 1 and 2. The difference between 1 and 2 is that the brilliance is lowered more slowly in 2.

To use the wiper feature, do the following:

1. Open the menu then select [1 ECHO].
2. Select [8 WIPER].
3. Select [OFF], [1] or [2] as appropriate.
4. Close the menu.

2.13 How to Preset Controls for Specific Navigation Purpose

Every time your navigating environment or task changes, you must adjust the radar, which can be a nuisance in a busy situation. Instead of changing radar settings case by case, it is possible to assign the function keys to provide optimum settings for often-encountered situations.

The radar's internal computer offers several picture preset options to be assigned to each function key for your specific navigating requirements. For instance, one of the presets is labeled [HARD RAIN], and is designed to be used in heavy rain.

Two user-programmable presets are also provided (labeled [CUSTOM1], [CUSTOM2]), so that you can have the radar automatically adjusted to those conditions that are not covered by the provided setup options.

Below are the preset options provided with this radar.

Label	Description	Label	Description
OCEAN	Optimum setting for long range detection, on a range scale of 6 NM or larger.	HARD RAIN	Optimum setting for rough weather or heavy rain.
CANAL	Optimum setting for operating in a canal.	ICE* (optional specification)	Optimum setting for showing areas of ice on the sea surface.
BERTHING	Optimum setting when berthing.	CUSTOM1	User-defined custom settings.
CONGESTION	Optimum setting for short range navigation (for example, a harbor) using a range scale of 1.5 NM or less.	CUSTOM2	User-defined custom settings.
ROUGH SEA	Optimum setting for operation in rough seas.		

* See "About the ICE custom setting (optional specification)" on page 2-14.

Each picture option defines a combination of several radar settings for achieving optimum setup for a particular navigating situation. These include interference rejector, echo stretch, echo average, noise rejector, automatic anti-sea and anti-rain clutters, video contrast, pulse length and sea and radar conditions.

Adjusting these features from the [CUSTOMIZE ECHO] menu changes the original function key settings. To restore the original settings for a particular customize option, it is necessary to select the default setting. For this reason, we recommended that you use the user-programmable presets ([CUSTOM1] or [CUSTOM2]) when frequent adjustment of the radar image is necessary.

The tables on the following page show the default settings for reference.

	INT REJECT	ECHO STRETCH	ECHO AVERAGE	NOISE REJECT	AUTO SEA	AUTO RAIN	VIDEO CONT- RAST
OCEAN	2	2	3	ON	OFF*	OFF*	3-B
CANAL	2	OFF	OFF	OFF	OFF*	OFF*	2-B
BERTH- ING	2	OFF	OFF	OFF	OFF*	OFF*	2-B
CONGES- TION	2	OFF	2	OFF	OFF*	OFF*	1-B
ROUGH SEA	2	OFF	2	OFF	OFF*	OFF*	2-A
HARD RAIN	2	OFF	OFF	OFF	OFF*	ON	2-A
ICE	2	OFF	OFF	OFF	OFF*	OFF*	ICE
CUS- TOM1	2	OFF	OFF	OFF	OFF*	OFF*	1-B
CUS- TOM2	2	2	1	OFF	OFF*	OFF*	2-B

*: Manual

PULSE LENGTH

	0.5 NM	0.75 NM	1.5 NM	3 NM	6 NM	12, 24 NM
OCEAN	S2	M1*	M1	M3	L	L
CANAL	S1	S2	M1	M2	M3	L
BERTHING	S1	S1	S2	M1	M3	L
CONGESTION	S1	S2	S2	M1	M2	L
ROUGH SEA	S1	S1	S2	M1	M2	M3
HARD RAIN	S1	S2	S2	M1	M2	L
ICE	S1	S1	S1	S2	M1	M1/M2
CUSTOM1	S1	S2	S2	M1	M1	L
CUSTOM2	S2	S2	M1	M2	M3	L

*: S2 for solid state radar.

CONDITION

	STC ANT HEIGHT	LOW LEVEL ECHO	GAIN	SEA	RAIN	ACE
OCEAN	Set at installation	0	80	MAN-30	MAN-0	OFF
CANAL		0	80	MAN-30	MAN-0	OFF
BERTHING		0	80	MAN-30	MAN-0	OFF
CONGESTION		0	80	MAN-30	MAN-0	OFF
ROUGH SEA		0	80	MAN-60	MAN-0	OFF
HARD RAIN		0	80	MAN-60	AUTO	OFF
ICE		0	80	MAN-30	MAN-0	OFF
CUSTOM1		0	80	MAN-30	MAN-0	OFF
CUSTOM2		0	80	MAN-30	MAN-0	OFF

About the ICE custom setting (optional specification)

The [ICE] custom setting sets up the radar to detect areas of ice on the sea surface. With ICE active, the following restrictions or requirements apply.

- Turn off [COMBINE FUNC] in the radar installation menu to enable the [ICE] custom setting. See the installation manual.
- EAV 2, EAV 3, video contrast and ACE are inoperative.
- The video contrast setting for the performance monitor is fixed at [ICE] also.
- When a FAR-3xx0 operates as the main radar, and a FAR-2xx7 as a sub radar, the areas of ice will not be displayed in the correct echo color on the FAR-2xx7. For this reason, do not use this radar combination when ICE is active.

2.13.1 How to select a customized echo

Click the [Customize Echo] button on the Status bar to select a customize echo option from the drop-down list.



2.13.2 How to edit a customized echo

You can edit a customized echo as below.

1. Select a customize echo option to edit (see subsection 2.13.1).

2. Right-click the [Customize Echo] button on the Status bar then click [Customize Echo Menu].

3. Set the items below referring to the sections shown.

[1 INT REJECT]: section 2.7

[2 ECHO STRETCH]: section 2.8

[3 ECHO AVERAGE]: section 2.9

[4 NOISE REJECT]: section 2.11

[5 AUTO SEA]: section 2.5

[6 AUTO RAIN]: section 2.6

[8 PULSE]: section 2.3

[1 ACE]: section 2.10

4. Click [7 VIDEO CONTRAST].

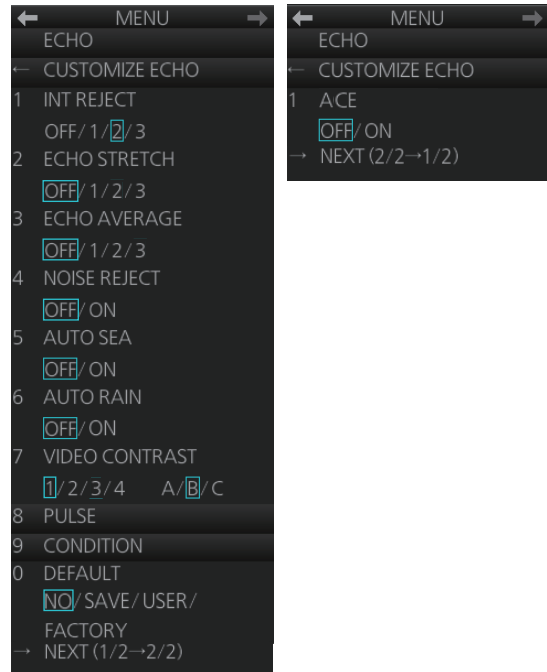

5. Spin the scrollwheel to select 1, 2, 3 or 4 (Dynamic Range) or A, B, C (Curve) as appropriate then push the left button. Refer to the description and illustration below.

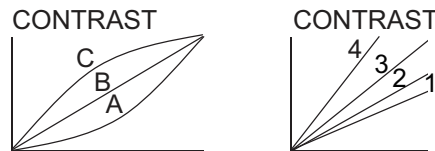

1-4: Control dynamic range. 1 provides the widest dynamic range; 4 is the narrowest dynamic range.

A: The mid-level in the curve is low, so this setting is suitable for suppressing rain clutter.

B: Curve between A and C.

C: The mid-level in the curve is high, so this setting is suitable for detecting distant targets.

6. Click [9 CONDITION].
7. Click [2 STC ANT HEIGHT].
8. Spin the scrollwheel to select appropriate radar antenna height (above the waterline) then push the left button.
9. If necessary, select [3 LOW LEVEL ECHO] to reject low level echoes. The setting range is 0-8. The higher the figure, the stronger the low level echo that is erased.
10. To save the custom settings, select [SAVE] from [0 DEFAULT].

2.13.3 How to restore a user customized echo to the saved settings

If you get lost in operation while adjusting the settings for a user customized echo, you can easily restore the settings for that user customized echo saved at subsection 2.13.2).

1. Right-click the [Customize Echo] button on the Status bar then click [Customize Echo Menu].
2. Click [0 DEFAULT].
3. Select [USER].

2.13.4 How to restore a user customized echo to the factory default settings

You can erase a customized echo options to restore its factory default options (see the tables on pages 2-12 and 2-13).

1. Click the [Customize Echo] button on the Status bar to select [CUSTOM1] or [CUSTOM2] for which you want to restore its factory default settings.
2. Right-click the [Customize Echo] button on the Status bar then click [Customize Echo Menu].
3. Click [0 DEFAULT].
4. Select [FACTORY].

2.14 How to Suppress Second-trace Echoes

In certain situations, echoes from very far distance targets may appear as false echoes (second-trace echoes) on the screen. This occurs when the return echo is received one transmission cycle later, or after a next radar pulse has been transmitted.

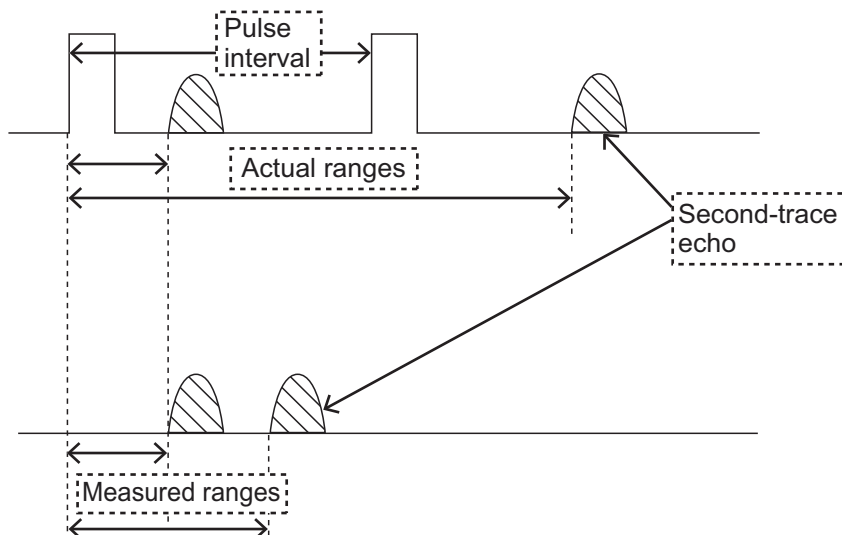

This equipment lengthens the pulse repetition period to reject the false echoes.

Note: This function decreases the number of echoes hits. Carefully use this function so that the possibility of detecting small targets and high-speed craft does not lessen.

To reject second-trace echoes, open the [1 ECHO] menu then set [5 2ND ECHO REJ] to [ON] then close the menu.

2.15 Presentation Modes

This radar has the following presentation modes in the radar mode:

Relative Motion (RM)

Head-up: Unstabilized.

STAB H UP: Head-up with compass-stabilized bearing scale (True Bearing) where the bearing scale rotates with the compass reading.

Course-up: Compass-stabilized relative to ship's orientation at the time of selecting course-up.

North-up: Compass-stabilized with reference to North.

Stern-up: Unstabilized.

True Motion (TM)

North-up: Ground- or sea-stabilized with compass and speed inputs.

Mode availability

Presentation mode	Availability	
	Radar	Chart radar
Course-up RM	Yes	Yes
Head-up RM	Yes	No
STAB H UP RM	Yes	No
North-up RM	Yes	Yes
North-up TM	Yes	Yes
Stern-up RM*	Yes	No

*: Not available with IMO or A type.

2.15.1 How to select a presentation mode

How to select a presentation mode from the Control Unit

Push the **MODE** key consecutively to select radar presentation mode desired. The Range/Presentation mode box shows the current presentation mode.

How to select a presentation mode from the Range/Presentation mode box

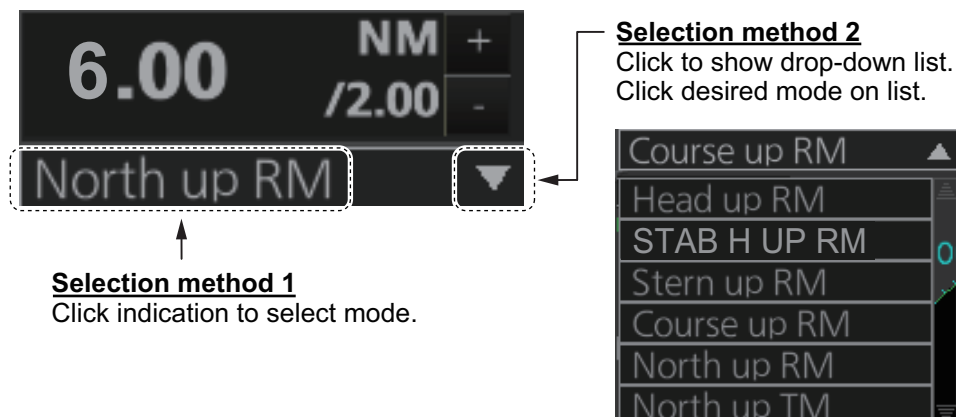

IMPORTANT

Loss of gyrocompass signal

When the gyrocompass signal is lost, the Alert "Gyro xxx COM1 Error" (xxx=a number between 255 and 259 (ALF format: between 10400,1 and 10400,5) according to gyro no.) appears in the [Alert] box. After all signals are lost, the Alert 450 (ALF format: 10601,9) "Heading Sensor Not Available" appears, the presentation mode becomes head-up and all TT and AIS are erased. Check the gyrocompass and select the presentation mode with the MODE key or the Range/Presentation mode box.

2.15.2 Description of presentation modes

Head-up mode

The head-up mode is a display in which the line connecting own ship and the top of the display indicates own ship's heading.

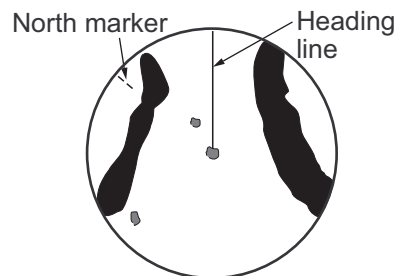

The target pips are painted at their measured distances and in their directions relative to own ship's heading.

The short line on the bearing scale is the north marker, which indicates heading sensor north. A failure of all the heading sensor inputs will cause the heading readout to disappear, and the Alert 450 (ALF format: 10601,9) "Heading Sensor Not Available" or "Gyro xxx COM1 Error" (a number between 255-259 (ALF format: between 10400,1 and 10400,5) according to gyro no.) appears in the [Alert] box.

Course-up mode

The course-up mode is an azimuth stabilized display in which a line connecting the center with the top of the display indicates own ship's intended course (namely, own ship's previous heading just before this mode has been selected).

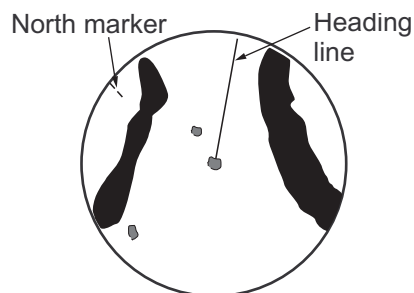

Target pips are painted at their measured distances and in their directions relative to the intended course, which is maintained at the 0-degree position. The heading line moves in accordance with ship's yawing and course change. This mode is useful for avoiding smearing of the picture during course change.

STAB Head-up mode

Radar echoes are shown in the same way as in the head-up mode. The difference from the normal head-up presentation lies in the orientation of the bearing scale. The bearing scale is heading sensor stabilized. That is, it rotates in accordance with the heading sensor signal, enabling you to know own ship's heading at a glance.

This mode is available when the radar is interfaced with a gyro heading sensor. If the gyro heading sensor fails, the bearing scale returns to the state of head-up mode.

North-up mode

The north-up mode paints target pips at their measured distances and in their true (heading sensor) directions from own ship, north bearing maintained at the top of the screen. The heading line changes its direction according to the ship's heading. Requires heading signal.

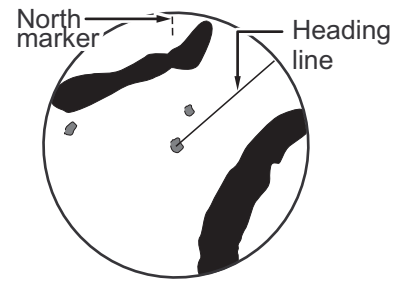

If the compass fails, the presentation mode changes to head-up and the north marker disappears. A failure of the heading sensor input will cause the heading readout to disappear, and the Alert 450 (ALF format: 10601,9) "Heading Sensor Not Available" or "Gyro COM1 Error" (a number between 255-259 (ALF format: between 10400,1 and 10400,5) according to gyro no.) appears in the [Alert] box.

Stern-up mode

The stern-up mode is a display in which the line connecting own ship and the top of the display indicates own ship's stern.

The target pips are painted at their measured distances and in their directions relative to own ship's stern.

The short line on the bearing scale is the north marker, which indicates stern sensor north.

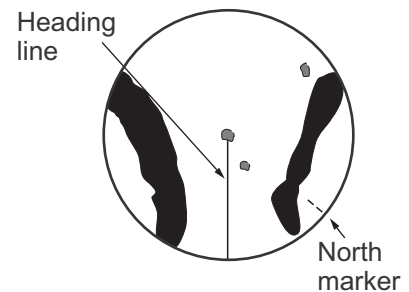
**True motion mode**

Own ship and other moving objects move in accordance with their true courses and speed. In ground stabilized TM, all fixed targets, such as landmasses, appear as stationary echoes. In the sea stabilized TM without set and drift inputs, the landmass can move on the screen. Note that true motion is not available on the 96 NM or higher range scale range scale. If COG and SOG (both over the ground) are not available on the TM mode, enter the set (tide direction) and drift (tide speed) manually referring to a Tide Table.

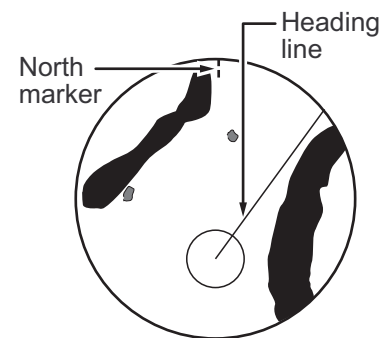

If the position of the CCRP results in a part of the bearing scale not being distinguishable, that part of the bearing scale is indicated with appropriate reduced detail.

A failure of the heading sensor input will cause the heading readout to disappear, and the Alert 450 (ALF format: 10601,9) "Heading Sensor Not Available" or "Gyro COM1 Error" (a number between 255-259 (ALF format: between 10400,1 and 10400,5) according to gyro no.) appears in the [Alert] box.

2. RADAR, CHART RADAR OPERATION

When own ship reaches a point corresponding to 50% of the radius of the display, own ship position is automatically reset to a point of 75% radius opposite to the extension of the heading line passing through the display center. You can also reset the own ship symbol manually by pushing the **CU/TM RESET** key, or click the [CU/TM reset] button on the InstantAccess bar™.

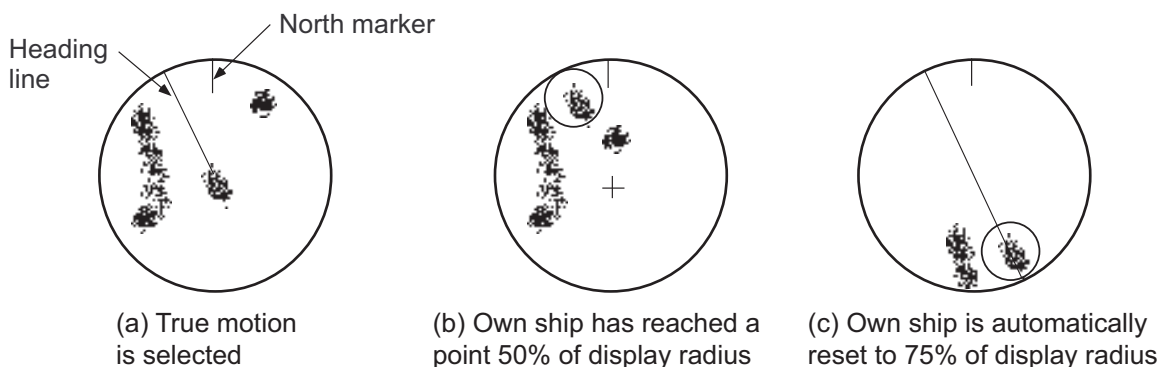

2.15.3 How to reset the course-up automatically

The heading line moves in accordance with ship's yawing and course change. During course-up mode, you can reset the heading line automatically to match the course.

1. Open the menu then select [8 INITIAL SETTING] and [6 AUTO COURSE UP RESET].
2. Select [ON].
3. Spin the scrollwheel to set the angle (22.5° to 45.0°) then push the left button. When the angle between the heading line and the course reaches the setting, the heading line automatically matches the course.

2.15.4 How to scroll the display in true motion mode (B-type only)

The display can be scrolled manually in the true motion mode with the B-type specification radar.

1. Open the menu then select [8 INITIAL SETTING] and [NEXT].
2. Set [1 TM CURSOR SCROLL] to [ON] to enable scrolling.
3. Put the cursor at an edge of the screen to scroll the screen.

2.16 How to Select the Range Scale

The selected range scale and range ring interval are shown at the top-left position on the screen. When a target of interest comes closer, reduce the range scale so that it appears in 50-90% of the display radius.

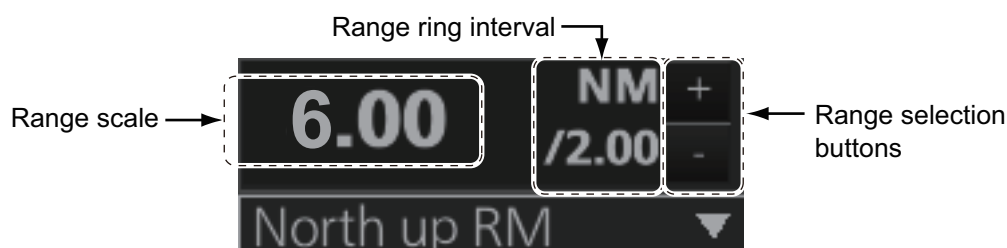

Note: The IMO- and A-type radars do not have the 1 NM, 2 NM, 4 NM, 8 NM, 16 NM and 32 NM ranges.

How to select a range scale from the Control Unit

Use the **RANGE** key to select range desired. Hit the "+" part of the key to raise the range; the "-" part to lower the range.

How to select a range scale from the Range/Presentation mode box

Method 1: Click the range scale indication.

Method 2: Click the range selection buttons. Click the "+" button to raise the range; the "-" button to lower the range.

Method 3: Right-click the range scale indication to show a drop-down list of available ranges then click a range.

2.17 How to Measure the Range to a Target

The range to a target may be measured three ways: with the fixed range rings, with the cursor, or with the VRM.

Use the range rings to obtain a rough estimate of the range to a target. They are the concentric solid circles about own ship, or the sweep origin. The number of rings is automatically determined by the selected range scale and their interval is displayed in the Range/Presentation mode box at the top-left position on the screen. Count the number of rings between the center of the display and the target. Check the range ring interval and judge the distance of the echo from the inner edge of the nearest ring.

The range rings can be turned on/off with [RANGE RING] on the [NAV TOOL] menu.

2.17.1 How to measure the range by using a VRM

There are two VRMs, No. 1 and No. 2, which appear as dashed rings so that you can distinguish them from the fixed range rings. The two VRMs can be distinguished from each other by the different lengths of their dashes; the dashes on the No. 2 VRM are longer.

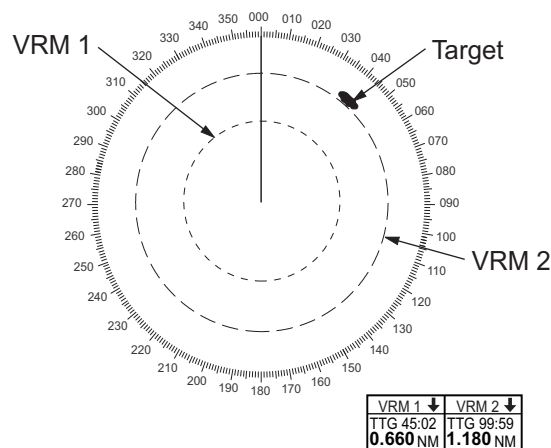

How to measure the range from the Control Unit

1. Press the **VRM 1** or **VRM 2** key to display desired VRM.

2. RADAR, CHART RADAR OPERATION

2. Rotate the **VRM rotary** control to align the active variable range marker with the inner edge of the target of interest and read its distance at the bottom-right position on the screen. Each VRM remains at the same geographical distance when you operate the range control. This means that the apparent radius of the VRM ring changes in proportion to the selected range scale.

To erase a VRM, press the **VRM 1** or **VRM 2** key to erase corresponding VRM.

How to measure the range from the trackball module

1. Click the title bar on a VRM box to activate the corresponding VRM.
2. Click the VRM box.
3. Use the trackball to align the active variable range marker with the inner edge of the target of interest and read its distance at the bottom-right position on the screen. Each VRM remains at the same geographical distance when you operate the range control. This means that the apparent radius of the VRM ring changes in proportion to the selected range scale set the outer edge of the VRM on the inner edge of the target.
4. To anchor the VRM, push the left button.

To turn off a VRM, click the arrow in the applicable VRM box. The VRM disappears and the VRM box is minimized.

2.17.2 How to set VRM attributes

You can customize the VRMs to suit your needs.

1. Open the menu then select [3 NAV TOOL] and [2 EBL•VRM] (B type) or [2 EBL•VRM•CURSOR] (IMO and A types) to display the [EBL•VRM] menu ([EBL•VRM•CURSOR] menu for the IMO and A types).
2. **For the B-type radar**, select [3 VRM1] or [4 VRM2] as appropriate. Spin the scrollwheel to select desired unit then push the left button.
3. Select [6 VRM TTG] and then select the VRM(s) that are to show/hide the TTG indication. [OFF] shows no TTG indication.
4. The [LINK EBL] option for [7 VRM OFFSET] automatically activates the corresponding VRM when the offset EBL is enabled.
5. Close the menu.

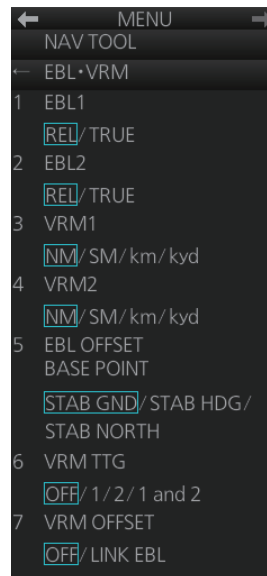

B-type radar

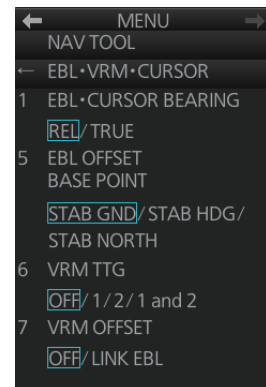

IMO- and A-type radars

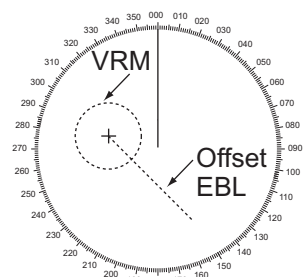

2.18 How to Measure the Bearing to a Target

Use the Electronic Bearing Lines (EBLs) to take bearings of targets. There are two EBLs, No. 1 and No. 2. Each EBL is a straight dashed line extending from the own ship position up to the circumference of the radar picture. The two EBLs can be distinguished from each other by the different lengths of their dashes; the dashes on the No. 2 EBL are longer.

Each EBL carries a range marker, or a short line crossing the EBL at right angles. Its distance from the EBL origin is indicated at the VRM readout whether or not the corresponding VRM is displayed. The range marker changes its position along the EBL with the rotation of the VRM control. To operate this marker, rotate the **VRM rotary** control on the Control Unit, or put the cursor in the applicable VRM box and roll the scrollwheel.

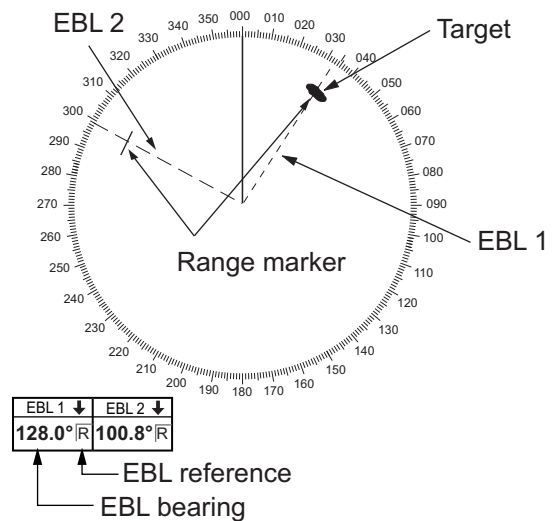

2.18.1 How to measure the bearing

How to measure the bearing from the Control Unit

1. Press the **EBL 1** or **EBL 2** key to display desired EBL.
2. Rotate the **EBL rotary** control to bisect the target with the EBL. Read the bearing to the target at the appropriate EBL box.

To erase an EBL, press the **EBL 1** or **EBL 2** key to erase corresponding EBL.

How to measure the bearing from the trackball module

1. Click the title bar on a EBL box to activate the corresponding EBL.
2. Click the EBL box.
3. Use the trackball to bisect the target with the EBL.
4. To anchor the EBL, push the left button.

To turn off an EBL, click the arrow in applicable EBL box. The EBL disappears and the EBL box is minimized.

2.18.2 How to select bearing reference

An EBL box has an "R" (relative) if the EBL bearing is relative to own ship's heading; "T" (true) if it is referenced to the north. True or relative indication is available regardless of presentation mode.

To change the bearing reference, click the EBL reference indication to display R or T as appropriate. The bearing reference can also be selected on the [EBL•VRM] menu ([EBL•VRM•CURSOR] menu with the IMO- and A-type radars).

Note: When the gyrocompass heading changes, the EBL and its indication change as follows:

Course-up, relative:	EBL indication remains the same, EBL moves.
Course-up, true:	EBL indication and EBL remain unchanged.
Head-up, relative:	EBL indication and EBL remain unchanged.
Head-up, true:	EBL indication remains the same; EBL moves.
North-up, relative:	EBL indication remains the same, EBL moves.
North-up, true:	EBL indication and EBL remain unchanged.

2.19 Collision Assessment by Offset EBL

The origin of the EBL can be placed anywhere with the trackball to enable measurement of range and bearing between two targets. This function is also useful for assessment of the potential risk of collision. It is possible to read CPA (Closest Point of Approach) by using a VRM as shown in Figure (a) on the next page. If the EBL passes through the sweep origin (own ship) as illustrated in Figure (b), the target ship is on a collision course.

2.19.1 How to assess risk of collision

How to assess risk of collision from the Control Unit

1. Press the **EBL 1** or **EBL 2** key to activate an EBL.
2. Put the cursor on a target that appears as a threatening target (A in the figure on the next page).
3. Press the **EBL OFFSET** key to shift the EBL origin to the cursor location.
4. Press the **EBL OFFSET** key again to anchor the EBL. Wait approx. three minutes, then operate the **EBL rotary** control to bisect the target at the new position (A'). The EBL indication shows the target ship's course, which may be true or relative depending on the EBL bearing reference setting.
5. If relative motion is selected, it is also possible to read CPA by using a VRM as shown in the left figure on the next page. If the EBL passes through the sweep origin (own ship) as illustrated in the right figure on the next page, the target ship is on a collision course.

To return the EBL origin to the center of the screen, press the **EBL OFFSET** key.

How to assess risk of collision from the context-sensitive menu

1. Right-click the display area to show the context-sensitive menu.
2. Select [EBL Offset] and then [EBL 1] or [EBL 2].
3. Put the cursor on a target that appears as a threat (A in the figure below).
4. Push the left button to shift the EBL origin to the cursor location.
5. Spin the scrollwheel or use the trackball to bisect the target at the new position (A'). The EBL indication shows the target ship's course, which may be true or relative depending on the EBL bearing reference setting.
6. It is also possible to read CPA by using a VRM as shown in left-hand figure below. If the EBL passes through the sweep origin (own ship) as illustrated in the right-hand figure below, the target ship is on a collision course.

To return the EBL origin to the center of the screen, click the EBL box.

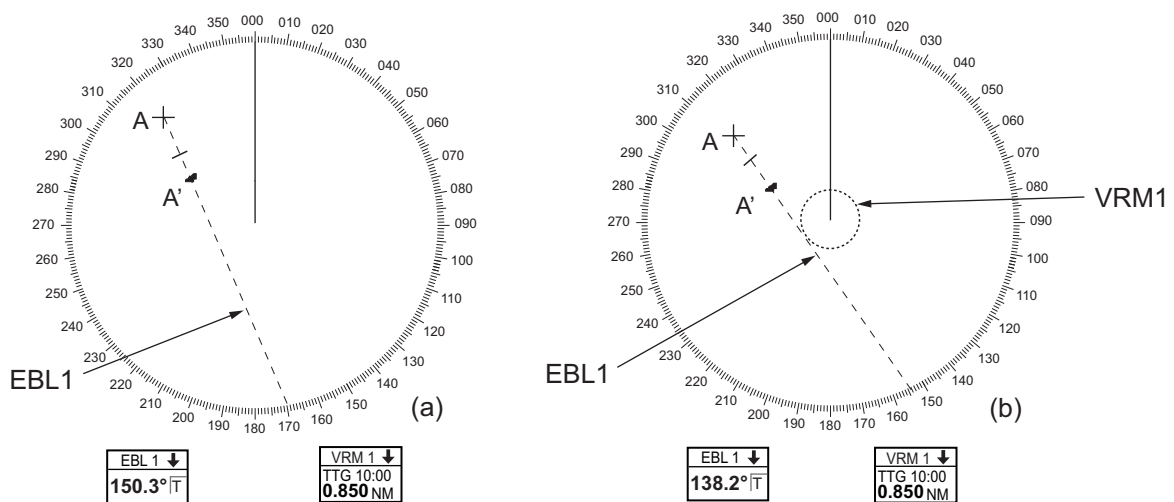
**2.19.2 Point of reference for origin point of offset EBL**

The origin point of the offset EBL can be ground stabilized (geographically fixed), north stabilized (true) or referenced to your ship's heading (relative).

1. Open the menu then select the [3 NAV TOOL] and [2 EBL•VRM] (B type) or [2 EBL•VRM•CURSOR] (IMO and A types) menus to display the [2 EBL•VRM] (B type) or [2 EBL•VRM•CURSOR] (IMO and A types) menu.
2. Select [5 EBL OFFSET BASE POINT].
3. Select [STAB GND], [STAB HDG], or [STAB NORTH] as appropriate.
 - STAB GND:** Reference to latitude and longitude. Origin position is always fixed regardless of your ship's movement.
 - STAB HDG:** Reference to heading. The relationship of relative bearing between origin position and own position is kept always.
 - STAB NORTH:** Reference to North. The relationship of true bearing between origin position and own position is kept always.
4. Close the menu.

2.20 How to Measure the Range and Bearing Between Two Targets

How to measure the range and bearing between two targets from the Control Unit

1. Press the **EBL 1** key to activate EBL1.
2. Operate the trackball to place the origin of the EBL 1 on a target of interest.
3. Press the **EBL OFFSET** key.
4. Operate the **EBL rotary** control to bisect the other target of interest.
5. Press the **VRM 1** key to activate VRM 1.
6. Operate the **VRM rotary** control until the range marker on the EBL is on the inside edge of target 2.

You can repeat the same procedure on third and fourth targets (targets 3 and 4) by using the EBL 2 and the VRM 2.

Bearing is shown relative to own ship with suffix "R" or as a true bearing with suffix "T". To return the EBL origin to the screen center, push the **EBL OFFSET** key.

How to measure the range and bearing between two targets from the trackball module

1. Right-click the display area to show the context-sensitive menu.
2. Select [EBL Offset] then [EBL 1].
3. Put the origin of the EBL on a target of interest.
4. Push the left button to anchor the EBL.
5. Put the cursor on the EBL 1 box then spin the scrollwheel or use the trackball to bisect the other target of interest.
6. Put the cursor on the VRM 1 box then spin the scrollwheel to put the range marker on the EBL on the inside edge of target 2.

You can repeat the same procedure on third and fourth targets (targets 3 and 4) by using the EBL 2 and the VRM 2.

Bearing is shown relative to own ship with suffix "R" or as a true bearing with suffix "T". To return the EBL to its origin, click the EBL box.

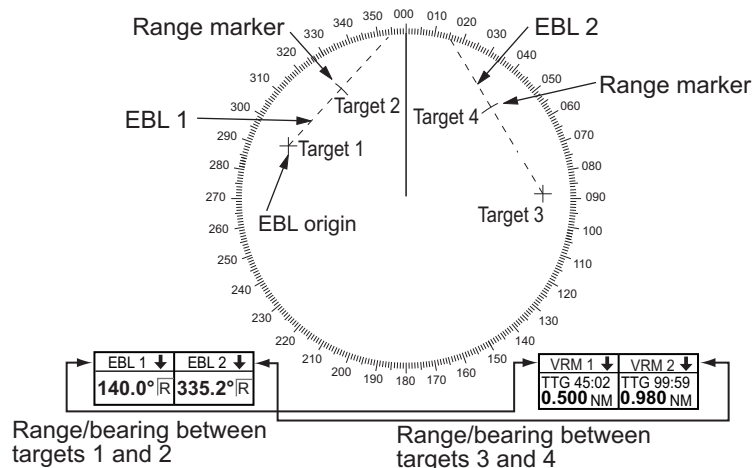

2.21 How to Off-center the Display

Own ship position, or sweep origin, can be displaced to expand the view field without switching to a larger range scale. The sweep origin can be off-centered to the cursor position, but not more than 75% of the range in use; if the cursor is put beyond 75% of the range scale, the sweep origin will be off-centered to the point of 75% of the limit.

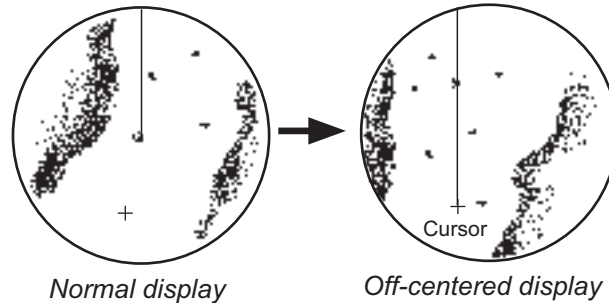

This feature is available on the ranges between 0.125 and 48 NM and any presentation mode other than true motion.

If the position of the CCRP results in a part of the bearing scale not being distinguishable, that part of the bearing scale is indicated with appropriate reduced detail.

How to off-center the display from the Control Unit

1. Put the cursor on the position within the display area where you want to move the sweep origin.
2. Press the **OFF CENTER** key to move the sweep origin to the cursor position.

To cancel off-centering, press the **OFF CENTER** key again.

How to off-center the display from the context-sensitive menu

1. Put the cursor in the display area then right-click to show the context-sensitive menu.
2. Select [Off Center].
3. Put the cursor where to put the sweep origin, and push the left button.

To cancel the off-center display, do steps 1 and 2 above, then click the display area.

If you cannot cancel off-center...

When the conditions shown below are met, off-center cannot be cancelled. This is because the radar antenna position is located at a position greater than 75% of the effective radar display.

- Own ship marker is large.
- The distance between the antenna position and the conning position is large.
- Short-distance display range.

To cancel the off-center in the above-mentioned conditions, first select a larger range, then cancel the off-center.

2.22 Target Trails

The trails of the radar echoes of targets may be displayed in the form of synthetic afterglow. Target trails are selected either relative or true and may be sea or ground stabilized. True motion trails require a compass signal, and position and speed inputs.

2.22.1 Target trails-related indications

Trail-related indications are located at the bottom-right position on the screen. Several trail-related operations can be done from the [TRAIL] menu, which you can show by right-clicking the Trail time indication. You can also left-click the trail time indication to change the trail time.

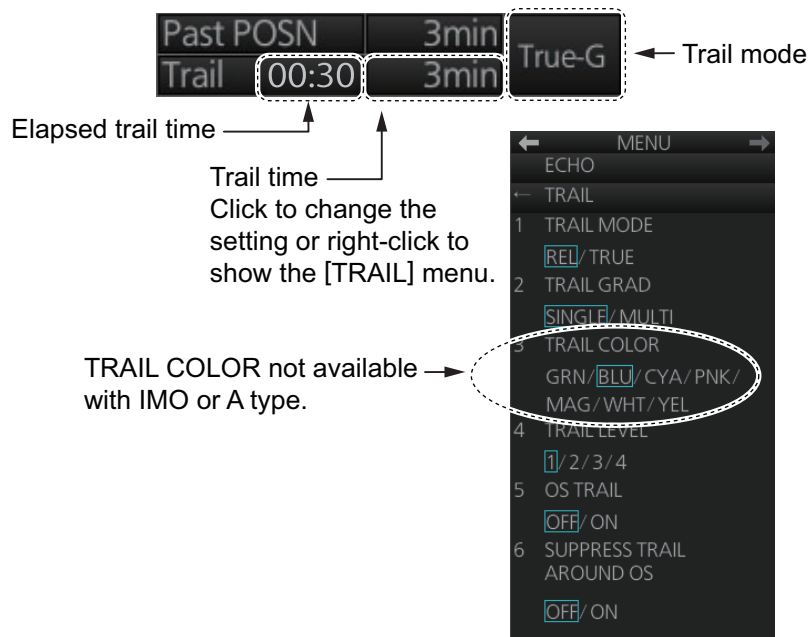

2.22.2 True or relative target trails

You may display echo trails in true or relative motion. Relative trails show relative movements between targets and own ship. True motion trails present true target movements in accordance with their over-the-ground speeds and courses.

Click the Trail mode indication to select [True-G], [True-S] or [REL] as appropriate.

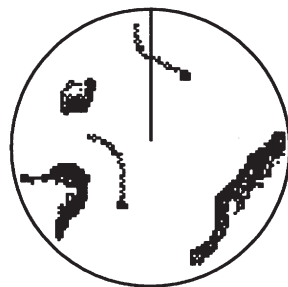

True target trails
(No smearing of stationary targets)

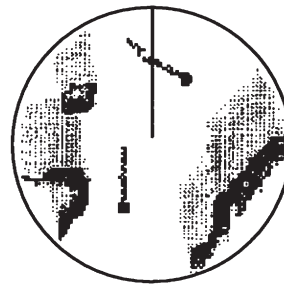

Relative target trails
(Targets moving relative to own ship)

2.22.3 Trail time

Trail time, the trail plotting interval, can be selected with the scrollwheel, left button or right button.

The trail timer counts up the trail time and is erased once the terminal count is reached. For example, if the trail time is six minutes, the timer is erased when trails have been plotted six minutes. The maximum time of count up for continuous plotting is 29:59.

Note: Caution is advised when using the trail timer, as the trail accuracy of other ship's echoes may be lowered.

How to select a trail time

Four controls are available to select a trail time.

- **Control Unit:** Push the **TRAIL** key.
- **Trackball module:** Put the cursor on the Trail time indication at the bottom-right position then operate the control (left button or scrollwheel). For the right button, a context-sensitive menu appears. Click the desired time.

The times available depend on the control used as shown in the table below.

Control	Available setting
Left button, right button, TRAIL key	OFF, 15 sec, 30 sec, 1 min, 3 min, 6 min, 15 min, 30 min, CONT(inuous)
Scrollwheel	OFF, 15 sec, 30 sec, 1-30 min (30 sec intervals), CONT(inuous)

2.22.4 How to reset target trails

All trails can be erased (including those in the memory) and restarted to start trails fresh.

Control Unit: Press and hold down the **TRAIL** key until trails disappear.

Context-sensitive menu: Right-click the Trail box to show the context-sensitive menu then select [Trail All Clear].

2.22.5 How to temporarily remove all target trails from the display

You can temporarily remove all trails from the display. Trails are removed but are continued internally.



Control Unit: Press the **TRAIL** key to show [OFF] in the trail time indication.

Trackball module: Click the trail time indication to display [OFF].

2.22.6 Trail stabilization in true motion

True motion trails can be ground stabilized or sea stabilized. The [Trail time] indication shows current stabilization as [True-G] or [True-S]. To change the stabilization mode, open the [SPD] page of the sensor settings menu (see section 1.16) and set [Stabilization Mode] to Bottom (GPS) or Water (speed log).

2.22.7 Target trail attributes on the TRAIL menu

	<p>[1 TRAIL MODE]: Switch the trail mode to [REL] or [TRUE].</p> <p>[2 TRAIL GRAD]: The afterglow of the target trails can be shown in a single tone or gradual shading.</p> <div style="display: flex; justify-content: space-around; align-items: center;"> <div style="text-align: center;">  <p>Monotone (SINGLE)</p> </div> <div style="text-align: center;">  <p>Gradual shading (MULTI)</p> </div> </div> <p>[3 TRAIL COLOR]: The trail color can be selected from the colors shown in the left figure. This feature is not available with the IMO or A type.</p> <p>[4 TRAIL LEVEL]: The level (intensity) of the afterglow that extends from radar targets can be adjusted. The higher the number the greater the intensity of the afterglow.</p> <p>[5 OS TRAIL]: Show or hide trail for own ship.</p> <p>[6 SUPPRESS TRAIL AROUND OS]: You can prevent the display of sea clutter in true trails about your ship, to clear the radar picture.</p>
---	--

Note: [6 SUPPRESS TRAIL AROUND OS] is automatically turned on when [5 OS TRAIL] is activated. The possible ON/OFF combinations between [5 OS TRAIL] and [6 SUPPRESS TRAIL AROUND OS] are as shown in the table below.

Setting	ON/OFF pairings available			
[5 OS TRAIL]	OFF	ON	OFF	ON
[6 SUPPRESS TRAIL AROUND OS]	OFF	ON	ON	OFF
Remarks	No OS trail	-	-	Setting not possible

2.23 Parallel Index (PI) Lines

PI lines are useful for keeping a constant distance between own ship and a coastline or a partner ship when navigating. Up to six sets of PI lines are available depending on the maximum number of PI lines selected on the menu.

Control of the orientation and interval of the PI lines is done from the PI line box, which is at the bottom-left position.

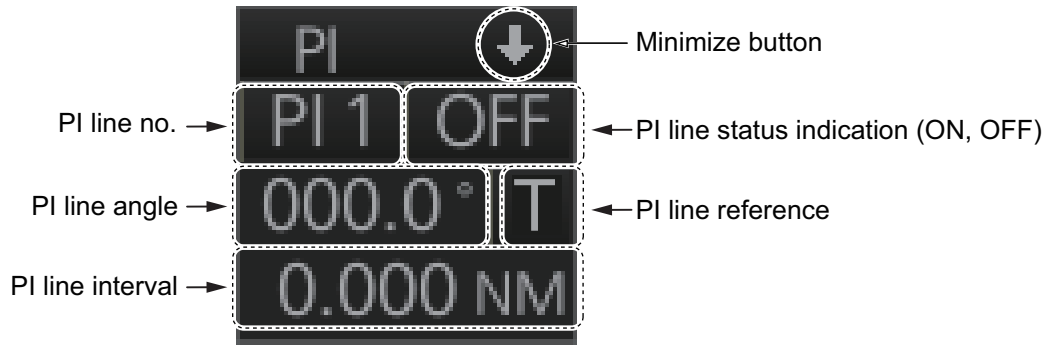
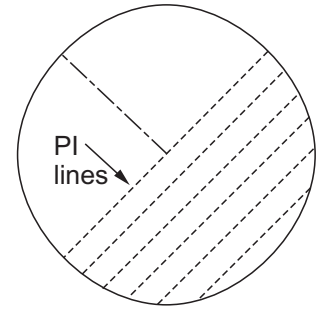

2.23.1 How to display, erase a PI line

How to display, erase a PI line from the Control Unit

Displaying a PI line: Press the **INDEX LINE** key until desired PI line no. appears.

Erasing a PI line: Press the **INDEX LINE** key until desired PI line no. appears. Press and hold down the **INDEX LINE** key to erase the PI line.

How to display, erase a PI line from the trackball module

Click the PI line no. indication to select a PI line. Click the PI line status indication (ON, OFF) to display or erase a PI line.

2.23.2 How to enable/disable PI lines

The PI line function can be enabled or disabled at any time. Disable this function to hide all PI lines and also disable the PI line box. To use the PI line box, enable this function.

1. Open the menu.
2. Select [3 NAV TOOL] and [1 PI LINE] to show the [PI LINE] menu.
3. Select [2 SET ALL PI LINE], then select [OFF] to disable the PI line function, or select [ON] to enable the PI line function.
4. Close the menu.

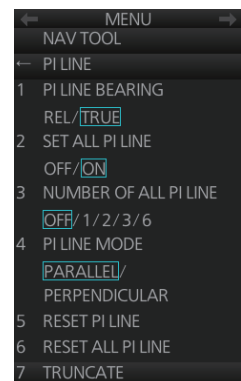

2.23.3 How to adjust PI line orientation, PI line interval

1. If not already displayed, display a PI line.
2. Put the cursor on the PI line angle indication then spin the scrollwheel to set the angle (000 to 359.9).
3. Put the cursor on the PI line interval indication then spin the scrollwheel to adjust the PI line interval.

2.23.4 How to select the number of PI lines to display

You can select the number of PI lines to display among 1, 2, 3 or 6.

For all PI lines

1. Open the menu.
2. Select [3 NAV TOOL] and [1 PI LINE] to show the [PI LINE] menu.
3. Select [3 NUMBER OF ALL PI LINE] and the desired number of PI lines among [1], [2], [3] or [6].
Note: This setting cannot be changed if [2 SET ALL PI LINE] is set to [OFF] in the [PI LINE] menu.
4. Close the menu.

For individual PI line

1. Select the PI line no. to set the number of PI lines referring to subsection 2.23.1.
2. Right-click the PI line box to show the context-sensitive menu then select [Number of PI Line].
3. Select the desired number of PI lines among [1], [2], [3] or [6].

Note: The actual number of lines visible can be less depending on line interval.

2.23.5 How to select the bearing reference for the PI line

PI line bearing reference can be relative to your ship's heading (Relative) or referenced to North (True).

Note: This function is not available with IMO type. The setting is fixed to [True].

1. Open the menu.
2. Select [3 NAV TOOL] and [1 PI LINE] to show the [PI LINE] menu.
3. Select [1 PI LINE BEARING].
4. Select [REL] or [TRUE].
5. Close the menu.

2.23.6 How to select the PI lines orientation

1. Open the menu.
2. Select [3 NAV TOOL] and [1 PI LINE] to show the [PI LINE] menu.
3. Select [4 PI LINE MODE].
4. Select [PARALLEL] or [PERPENDICULAR].
[PARALLEL]: PI lines are displayed in parallel to your ship's heading when PI line angle is set to 0°.
[PERPENDICULAR]: PI lines are displayed in perpendicular to your ship's heading when PI line angle is set to 0°.
5. Close the menu.

2.23.7 How to reset PI lines

You can automatically return all or selected PI lines to default orientation, 0-degrees for parallel orientation, 90-degrees for perpendicular orientation. This is faster than doing it manually.

1. Open the menu.
2. Select [3 NAV TOOL] and [1 PI LINE] to show the [PI LINE] menu.
3. Select [5 RESET PI LINE] (reset currently displayed line) or [6 RESET ALL PI LINE] as appropriate. The confirmation message "Attention: Do you wish to reset PI No.x line setting?" or "Attention: Do you wish to reset all PI line settings?" appears. Click the [OK] button to reset the PI line(s).
4. Close the menu.

2.23.8 How to adjust PI line length

You can adjust the length of each PI line. This function is available when [2 SET ALL PI LINE] is set to [1].

1. If not already displayed, display a PI line to adjust the length referring to subsection 2.23.1.
2. Open the menu.
3. Select [3 NAV TOOL] and [1 PI LINE] to show the [PI LINE] menu.
4. Select [7 TRUNCATE].
5. Select [ON] in [PI 1 (or 2, 3, 4, 5, 6) TRUNCATE].

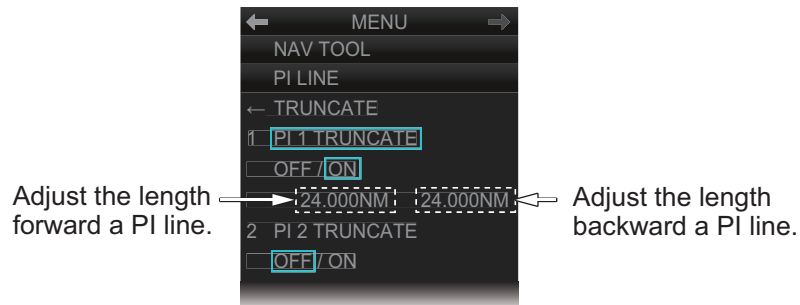

6. Set the length (setting range: 0.000 to 24.000 NM).

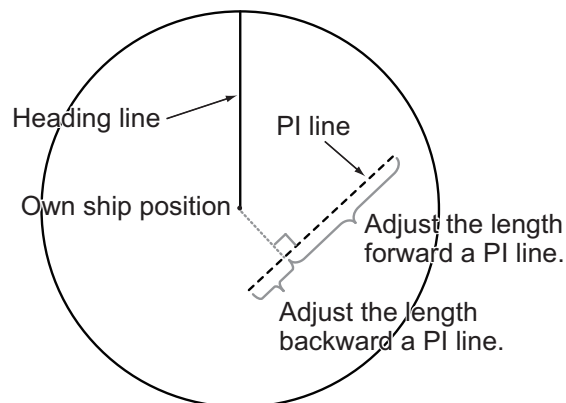

7. Close the menu.

2.24 Zoom

The zoom function enlarges an area of interest in the information area (magnification range: 1.0, 1.5, 2.0, 2.5, 3.0; 2.0 is default). To use the zoom display, right-click the operational area to show the context-sensitive menu then select [Zoom Set]. Roll the trackball to put the zoom cursor on the area to zoom. Spin the scrollwheel to change the magnification then push the left button to confirm the magnification and the position. See the zoom display at the right side of the screen.

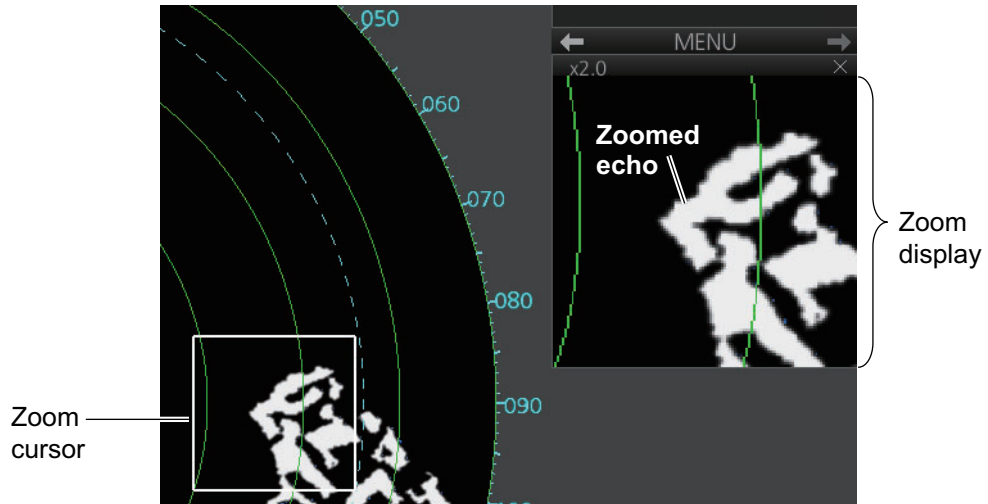

To deactivate the zoom function, right-click the operational area to show the context-sensitive menu then select [Zoom Off].

Zoom display format

You can select the zoom display format with the following procedure.

1. Open the menu then select [4 INFORMATION BOX] and [3 ZOOM DISPLAY].
2. Select the appropriate zoom display format:
 - [STAB GND]: Ground stabilized zoom (Geographically fixed).
 - [STAB HDG]: Heading stabilized zoom (Relative).
 - [STAB NORTH]: North stabilized zoom (True).
 - [TT TRACK]: Tracked targets are zoomed.
3. Close the menu.

2.25 Markers

2.25.1 Heading line

The heading line indicates the ship's heading in all presentation modes. The heading line is a line from the own ship position to the outer edge of the radar display area and appears at zero degrees on the bearing scale in head-up mode. It changes its orientation in the north-up and true motion modes according to orientation.

Temporarily erasing the heading line

To temporarily extinguish the heading line (and anything but radar echoes within the display area) to look at targets existing dead ahead of own ship, push the **HL OFF** key on the Control Unit, or click the [HL OFF] button on the InstantAccess bar™. Release the respective control to redisplay the heading line, etc.

2.25.2 Stern marker

The stern marker, which is a dotted line, appears opposite to the heading line and marks your ship's stern. To display or erase this marker, do the following:

1. Open the menu then select [5 MAP•MARK] and [1 MARK SETTING].
2. Select [6 STERN MARK].
3. Select [ON] or [OFF] as appropriate.

2.25.3 North marker

The north marker appears as a short dashed line. In the head-up mode, the north marker moves around the bearing scale in accordance with the compass signal.

2.25.4 Own ship marker

The own ship marker is displayed at your ship's position. It can be turned on or off and its configuration selected from the [MARK SETTING] menu. Two configurations are available: minimized marker and scaled marker. The scaled marker is scaled according to the length and beam of the vessel. If the beam width or length of the marker (set at installation) gets smaller than 3 mm, the marker is replaced with the minimized marker. Ship's dimensions should be entered at installation to use the scaled marker.

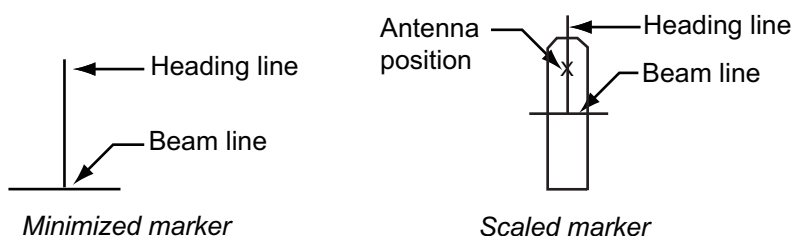

1. Open the menu then select [5 MAP•MARK] and [1 MARK SETTING].
2. Select [4 OWN SHIP MARK].
3. Select [MIN] or [SCALED] as appropriate.
 - MIN:** Show the minimized own ship marker.
 - SCALED:** Show the scaled own ship marker.

2.25.5 Vectors

You can show or hide the vector for own ship and reference targets, on the [NAV TOOL] menu.

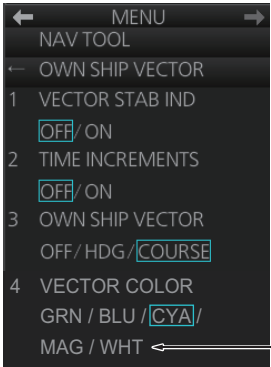
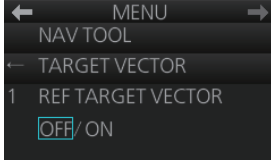
 <p>[OWN SHIP VECTOR] menu</p> <p>[1 VECTOR STAB IND]: Turn ON to show double arrow for ground tracking; single arrow for water tracking.</p> <p>[2 TIME INCREMENTS]: A short horizontal line can be marked on the own ship vector in one-minute intervals to show approximate later positions.</p> <p>[3 OWN SHIP VECTOR]: Turn vector OFF, or show ship's heading or course with a vector.</p> <p>[4 VECTOR COLOR]: Set the vector color for own ship.</p>	 <p>[TARGET VECTOR] menu</p> <p>[1 REF TARGET VECTOR]: Turn the vector for the reference target on or off.</p>
---	--

2.25.6 Barge marker

The length and breadth of the total barge size can be displayed as a simple rectangle on the radar display. Up to five rows of barges and nine barges per row can be shown.

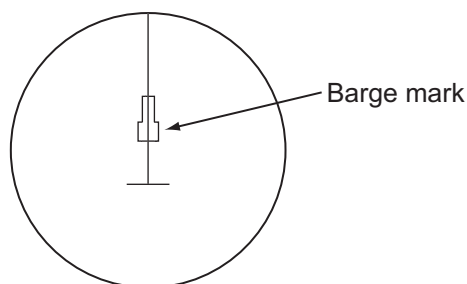

This feature is available with an installation preset. Set up barge information with the procedure on the following page:

2. RADAR, CHART RADAR OPERATION

1. Open the menu then select [3 NAV TOOL].
2. Select [7 BARGE].
3. Select [1 BARGE MARK].
4. Select [ON] to turn on the barge mark.
5. At [2 BARGE SIZE], enter length (three digits) and width (two digits) of the total number of barges.
6. Select [3 ARRANGEMENT].
7. Enter the number of barges that will be in front of your vessel, row by row:
 - 1) Select a barge row.
 - 2) Spin the scrollwheel to set the number of barges in the row. (The maximum number is nine.) The numerical indication to the right of the squares changes with scrollwheel operation.
 - 3) Push the left button to confirm your selection. The squares on the row are “filled” according to the number of barges selected at step 2.
8. Close the menu.

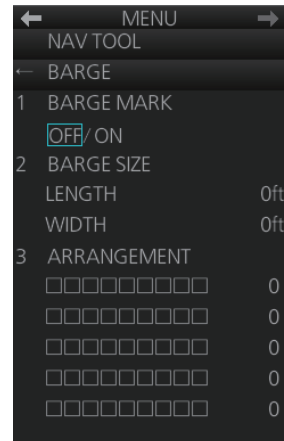

The radar display now shows the barge mark on the display.

2.25.7 Antenna marker

The antenna marker appears as a blue cross at the antenna location. The marker can be shown or hidden as follows:

1. Open the menu then select [5 MAP•MARK] and [1 MARK SETTING].
2. Select [5 ANTENNA MARK].
3. Select [ON] or [OFF] as appropriate.

2.25.8 Cursor

The cursor measures the range and bearing to an object, selects menu items, selects location for mark entry, etc. For the B-type radar, you can select cursor attributes (bearing reference, range unit and size for the cursor) on the [CURSOR] menu in the [NAV TOOL] menu. For the IMO- and A-type radars you can select only the cursor bearing reference, with [1 EBL•CURSOR BEARING] in the [EBL•VRM•CURSOR] menu of the [NAV TOOL] menu.

	<p>[1 CURSOR BEARING]: Show cursor bearing reference in true or relative.</p> <p>[2 CURSOR RANGE]: Show the cursor range indication in the NM, SM, km or kyd. Not available with either IMO- or A-type radar.</p> <p>[3 CURSOR SIZE]: Select the cursor size for small or large. The large cursor covers the entire echo area. Not available with either IMO- or A-type radar.</p>
--	--

2.25.9 Curved EBL

The [Curved EBL] function, available in the chart radar mode, shows the planned steering radius. You can use this function to determine the best location to begin a turn. You can also use the [Curved EBL] function to determine whether a turn is conducted as planned.

To show/hide the [Curved EBL], click the [ON]/[OFF] button on the [Curved EBL] page of the [Overlay/NAV Tools] box.

Note: This function is only available when a EC-3000 with TCS functionality (optional specification) is connected to the network.

1. Open the menu and select [5 MAP•MARK] and [MARK SETTING].
2. Select [DISP CURVED EBL] from page 2 of the [MARK SETTING] menu.
3. Select [ON] to display the curved EBL, [OFF] to hide the curved EBL.
4. Close the menu.

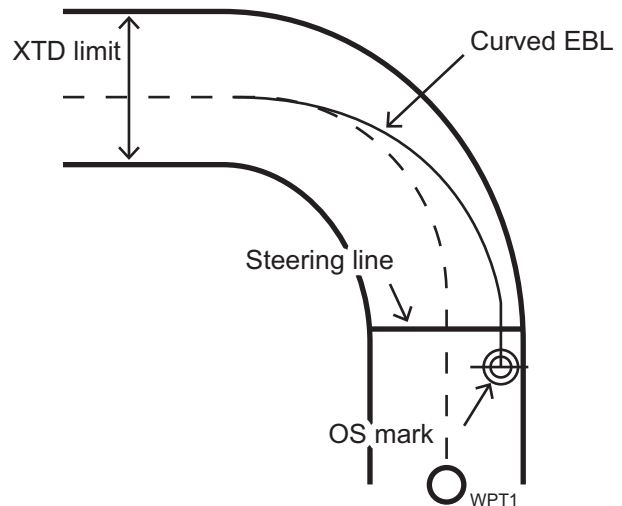

2.25.10 Display predictor

The predictor is a tool for estimating your ship's future positions and behavior. The on-screen predictor graphic consists of three pieces of your ship, drawn in true scale to successive future positions. The position of the third symbol will be your approximate position at the end of the time interval selected, which you set on the [Predictor] page in the [Overlay/NAV Tools] box. (See section 15.6.) The predictor is calculated using current speed and rate of turn. Docking speed components (transversal bow speed, transversal stern speed, transversal center speed and rate of turn) are assumed to be stable during the prediction period. The predictor can be used in every steering-state, including manual steering.

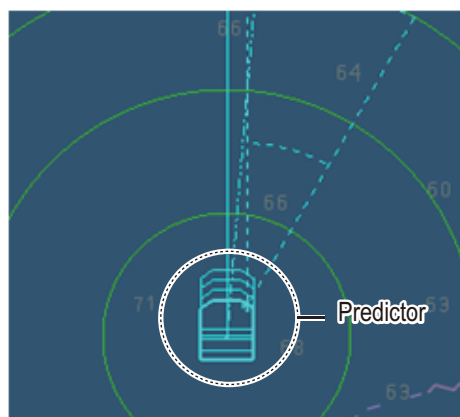

1. Open the menu then select [5 MAP•MARK] and [1 MARK SETTING].
2. Select [NEXT (1/2→2/2)].
3. Select [3 DISP PREDICTOR].
4. Select [ON] or [OFF] as appropriate.

2.26 How to Adjust Brilliance of Screen Data

You can adjust the relative brilliance levels of various markers and alphanumeric read-outs displayed on the screen.

1. Right-click the [BRILL] button on the InstantAccess bar™ then select [Brill Menu].



[BRIGHTNESS] menu, page 1 [BRIGHTNESS] menu, page 2

2. Click the brilliance adjustment bar of the item to adjust.

Page 1		Page 2	
Item	Adjust brightness of	Item	Adjust brightness of
[1 CONTROL PANEL]	backlighting of keys on Control Unit	[1 EBL]	EBLs, blind sector
[2 CHARACTER]	Alphanumeric characters	[2 VRM]	VRMs
[3 CURSOR]	Cursor	[3 PI LINE]	PI lines
[4 ECHO]	Radar echoes	[4 TT SYMBOL]	TT symbols, AZ area, TT vector, TT past posn
[5 TRAIL]	Target trails	[5 AIS SYMBOL]	AIS symbols, AIS vector, AIS past posn
[6 HL]	Heading line, stern line	[6 MARK]	Radar map marks, route, waypoint/MOB mark, anchor watch, drop1/2, zoom, north mark, user chart
[7 OS SYMBOL]	Own ship symbol, barge mark, antenna mark, own ship track, own ship vector	[7 CHART]	Chart-related objects
[8 RING]	Fixed range rings		
[9 BEARING CURSOR]	Bearing cursor		

3. Spin the scrollwheel to set brilliance level.
4. Close the menu.

2.27 Watch Alert

The watch alert provides a flashing visual alert at regular intervals to remind you to monitor the radar picture for safety or other purposes.

To enable the watch alert, open the [8 INITIAL SETTING] menu followed by the [4 ALERT] menu. Select [1 WATCH ALERT] and set desired watch interval. The [Watch] box appears at the bottom-left position. (The watch interval can also be selected from the [Watch] box when the watch alert feature is active. Right-click the time indication in the [Watch] box to show a drop-down list of watch intervals. Select a watch interval from the list.)



The timer counts down from the interval set and when the time interval elapses;

- the buzzer sounds
- the visual Alert 500 (ALF format: 10499) “Watch Alert” flashes in orange in the [Alert] box
- the watch alert timer freezes at "0:00".

Stop the flashing visual alert with the **ALARM ACK** key on the Control Unit or click the [Alert] box.

After the alert is acknowledged the count-down sequence is repeated.

Note: The countdown can be restarted, before the count reaches 0:00, by clicking the countdown indication in the watch box.

2.28 Information Box

The information box shows navigation data and, when following a route set on the chart display, route information is also shown. You can navigate the information tabs by clicking the arrow buttons ([←] or [→]) at the top-right of the information box.

2.28.1 Information box contents

Navigation data

- Depth, analog and graph
- Current (tide) direction and speed
- Wind direction and speed
- Water temperature
- Current and wind gauge

Nav data requires appropriate navigation sensors and IEC 61162-1/2 sentences output from the sensor. If there is no sentence or data input, asterisks (**) appear at the corresponding indication.

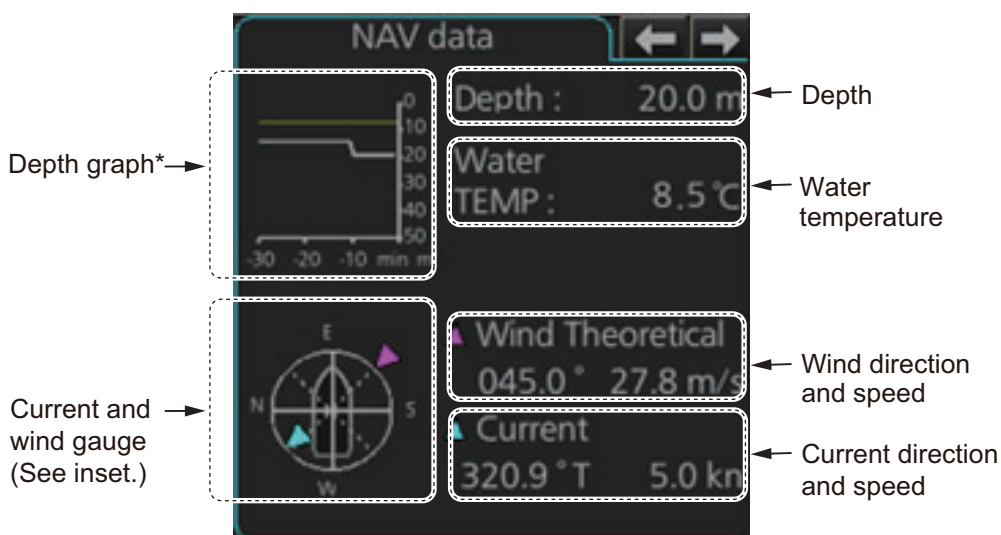

*: When a depth is set for [DEPTH MARK] in the [SET NAV DATA] menu, the set depth is indicated with a yellow line.

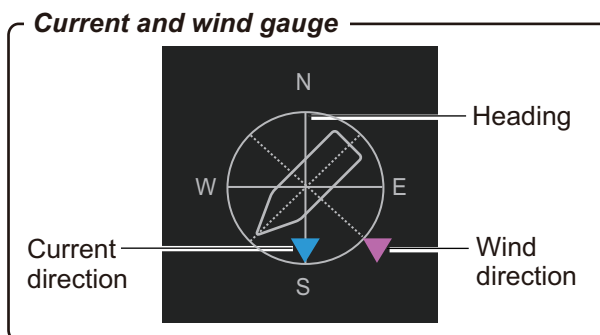

Route information

The route 1 information displays route name, plan speed, plan course, course to steer, XTD limit and XTD (off track). The route 2 information displays waypoint no., distance to WOP (wheel over point), time to go, planning turn radius, turn rate, next waypoint no., bearing to next waypoint.

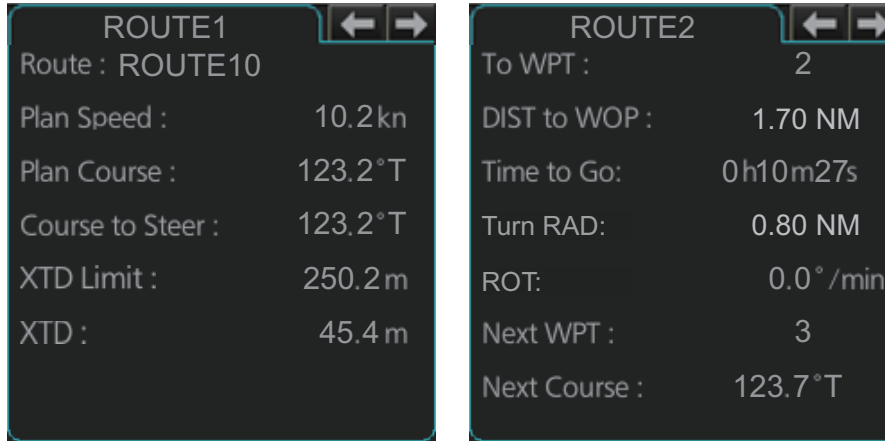

Route 1

Route 2

Wave data display

You can view wave data when a PC (with the wave analysis software installed) is connected to the same network as this radar. The software requires radar echo data in order to calculate and display wave data. For details, see section 2.28.4.

Note: To use the wave data display, connection with the analysis PC and software setup must be done at installation. Consult your local dealer.

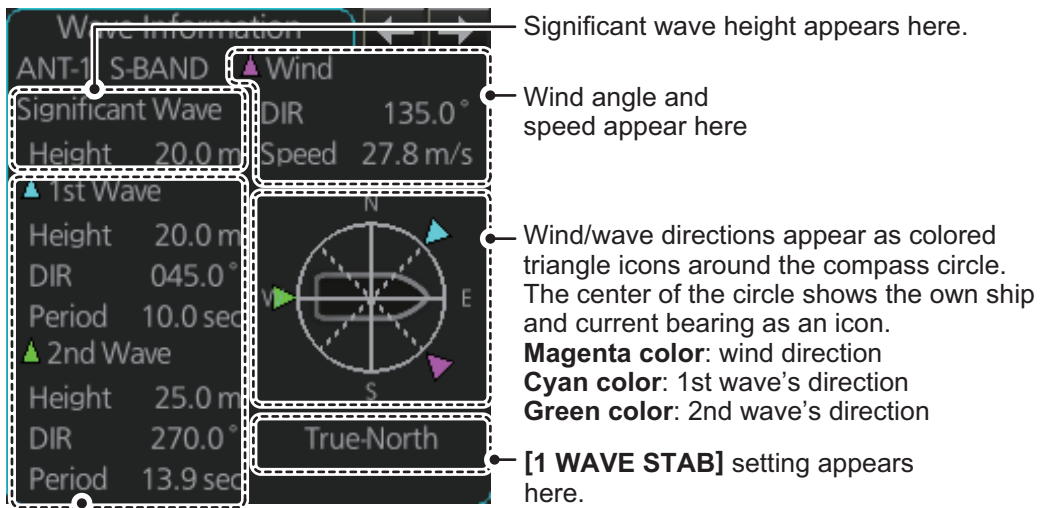

Wave information appears here.

[HEIGHT]: Wave height

[DIR]: Direction from which the wave is approaching.

[PERIOD]: Time until the wave meets own ship.

For details regarding the wave data display, see the manual supplied with the software (OMC-36181).

2.28.2 How to show the information box

1. Open the menu and select [4 INFORMATION BOX].

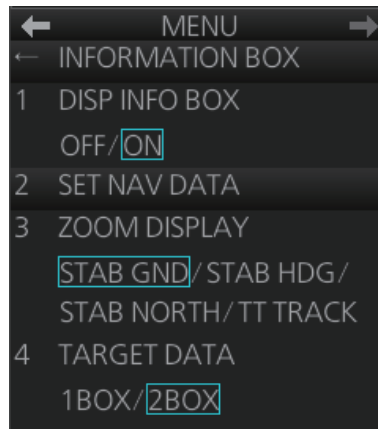

2. Select [1 DISP INFO BOX] then [ON].
3. Close the menu.

2.28.3 How to turn NAV data on/off

Wind, depth, ocean current and water temperature may be set up as follows:

1. Open the menu then select [4 INFORMATION BOX].
2. Select [2 SET NAV DATA].

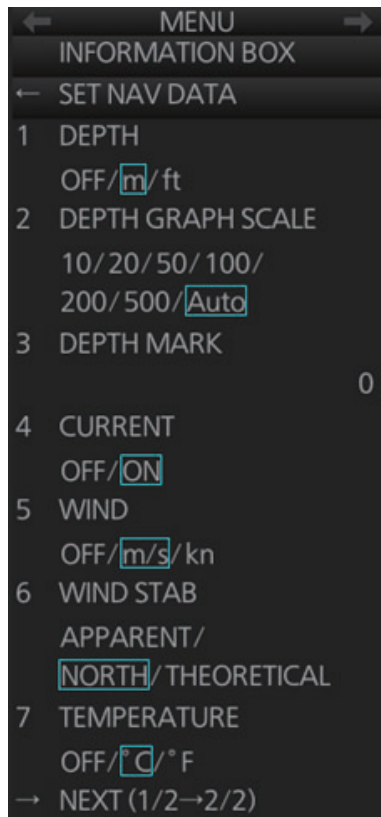

Page 1

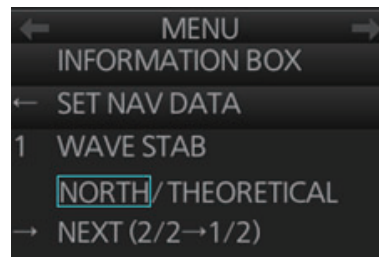

Page 2

3. Set up the nav data referring to the table on the following page.

Item	Description
Page 1	
[1 DEPTH]	Selects the unit of depth measurement, or turn depth indication off.
[2 DEPTH GRAPH SCALE]	Selects depth scale range. The depth for the last 30 minutes is plotted with a yellow line. The [Auto] setting automatically adjusts the scale according to depth.
[3 DEPTH MARK]	Selects the depth at which to show the depth mark.
[4 CURRENT]	Turns the current (tide) display on (current relative to North) or off.
[5 WIND]	Selects the unit of wind speed measurement.
[6 WIND STAB]	Selects Wind vector format, among three choices: [APPARENT]: Apparent wind measured by wind meter, with ship's bow as reference. [NORTH]: Apparent wind minus ship's movement, with North as reference. [THEORETICAL]: Apparent wind minus ship's movement, with ship's bow as reference.
[7 TEMPERATURE]	Selects the unit of water temperature measurement, or turns water temperature indication off.
Page 2	
[1 WAVE STAB]	Set the stabilization for the echo data output for wave analysis. [NORTH]: Apparent wave minus ship's movement, with North as reference. [THEORETICAL]: Apparent wave minus ship's movement, with ship's bow as reference. Note: This menu item appears only when setup and connection with a wave analysis PC is done at installation.

Note: Appropriate sensors are required to display any data. The wind vector shows a direction from which the wind blows in, relative to own ship heading, and is labeled "T *". Wind velocity is a true wind speed as a result of compensating for own ship's speed and orientation. Ocean current (tide) is shown relative to bow in head-up, cursor gyro and course-up, and reference to North in north-up and true motion.

4. Close the menu.

2.28.4 How to output data to the wave analysis software (option)

You can output echo data from this radar to a PC with the wave analysis software installed. The wave analysis software calculates incoming waves and gives you an on-screen indication as to wave size, direction and time between waves.

This section covers how to use enable data output for wave mode. For details regarding the analysis software and PC indications, see the manual supplied with the software.

Preparations and cautions for wave mode

- Wave mode requires the connection of a PC to the same network as this radar.
 - The connected PC must have the wave analysis software installed. See the software manual for how to install the software.
 - Wave mode may only be active on one radar at any time. If a second radar has wave mode activated, wave mode is disabled on the first radar.
 - Wave analysis and the output data are intended for reference purposes only, as an aid to safe navigation. Always confirm conditions, visually and with other methods.
 - The menu item [2 WAVE MODE] is not available in the following circumstances:
 - This radar is connect via interswitch with another radar.
 - The connected antenna is malfunctioning, or the LAN connection with the antenna is unstable or severed.
 - The analysis PC and software are not connected with this radar.
1. Establish a LAN connection with the analysis PC.
 2. Open the menu, then select [1 ECHO].
 3. Select [NEXT], then [2 WAVE MODE].
 4. Select [ON] or [OFF] as appropriate.
[ON]: enables data output to the analysis PC.
[OFF]: disables data output to the analysis PC.
 5. Close the menu.

2.29 Interswitch

The interswitch uses a network to transfer multiple radar signals to the monitor units connected in the network. A master/slave relation can be set for a single radar signal and that signal can be shown on multiple displays. Up to four antennas and four display units can be connected. Set the radar display and antenna groups from the [Antenna] button on the Status bar.

When you switch to a different antenna, the heading skew and timing adjustment (set at installation) for that antenna are automatically applied.

The [Antenna] button on the Status bar shows current antenna selection.

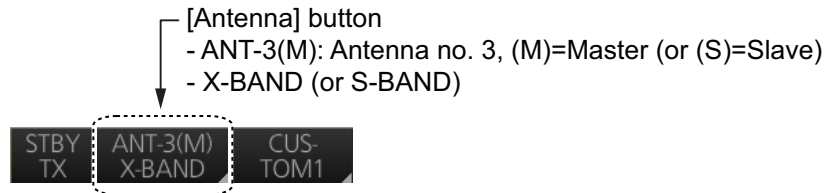

Note: Switch to a different antenna or change the interswitch settings in the standby mode.

2.29.1 Displaying antenna information

The [ANT SELECT] menu shows:

- Radar band, output power and antenna position of each antenna currently powered. (If an antenna is not powered, its data area is blank.)
- Current antenna and display combinations.

To show antenna information, open the menu then select the [8 INITIAL SETTING] and [5 ANT SELECT] menus.

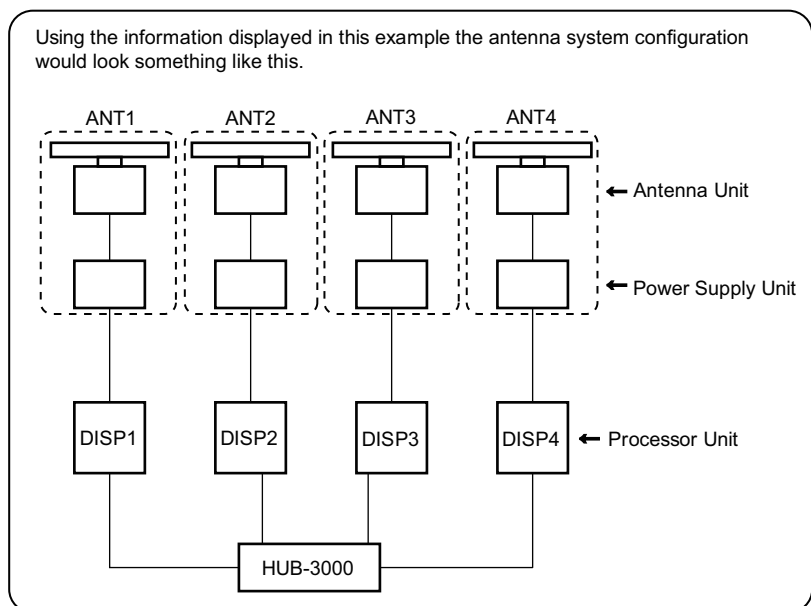
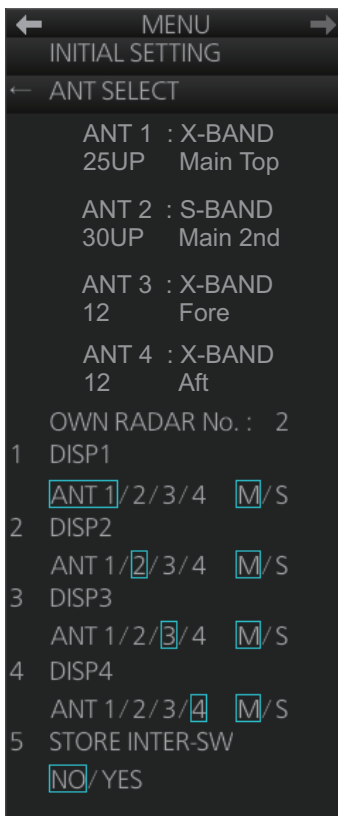

2.29.2 How to preset antenna and display combinations

You can preset the antenna and display combinations for each antenna and display in the radar system. As an example, the procedure below shows how to select the no. 1 antenna unit for the no. 2 display unit.

1. Open the menu then select the [8 INITIAL SETTING] and [5 ANT SELECT] menus.
2. Select the display unit for which to select an antenna (at the next step). For example, select [DISP2] to select the no. 2 display unit.
3. Select [ANT 1] and [M].
4. Repeat steps 2 and 3 to set other display and antenna combinations.
5. Click [STORE INTER-SW] and select [YES] to save your selections.
6. Close the menu.

Antenna selection considerations

- An antenna unit cannot be controlled from multiple display units. Select one Master display unit for one antenna unit. If two antenna units are set as masters, the display last-set as master becomes the master and all other displays are automatically changed to slave.
- An antenna unit without a Master display cannot be selected on the sub display units. If there is no antenna unit set as master, the lowest number display is automatically set as master.
- If the Alert 750 (ALF format: 10740,3) "EXT Radar COM Error" appears, do one of the following as applicable:
 - If only your antenna is not displayed on the [ANT SELECT] display, the LAN line in the Processor Unit may be faulty. In this case, use the standalone mode.
 - If the antenna that was in use does not appear on the [ANT SELECT] display, the LAN line in other Processor Unit may be faulty. In this case, see the preceding page for how to select a different antenna unit.
- When the Network fails, the Interswitch does not work, but standalone operation is possible.
- Radar functions are controlled independently, dependently or commonly depending on selection as Master or Slave (see the table on the next page).
- When connecting with an FAR-2xx7 or FAR-2xx8 series radar, the maximum number of acquired targets ([NUMBER OF TT]) should be set to 100 in the [RADAR INSTALLATION] menu. The service man only can set the [RADAR INSTALLATION] menu. Contact your dealer.
- Do not use the interswitch function when the icing prevention feature (see section 2.41) is active.

Compatibility of display and operation

- When connecting with FCR-2xx9 series radar
The FCR-2xx9 is compatible with the FAR-3xx0 in display and operation. For example, when switching the antenna from FAR-3xx0 to FCR-2xx9, the image for FCR-2xx9 is displayed on the screen and each function is operative, and vice versa.

- When connecting with FAR-2xx8 series radar
The FAR-2xx8 is compatible with the FAR-3xx0 in display and operation. For example, when switching the antenna from FAR-3xx0 to FAR-2xx8, the image for FAR-2xx8 is displayed on the screen and each function is operative, and vice versa.
- When connecting with FAR-2xx7 series radar
When switching the antenna from FAR-3xx0 to FAR-2xx7, the image for FAR-2xx7 is displayed on the screen and each function is operative. However, when switching the antenna from FAR-2xx7 to FAR-3xx0, the following functions are not operative.
 - Automatic Clutter Elimination (ACE) function
 - Selection of the transmit frequency by the [TX CH] button for solid state radar

Radar Functions	Control	Master Display Option	Slave Display Option
AIS function	Independent	Desired value can be set	Desired value can be set
Brilliance			
Echo trails			
EBL			
Lat/long data			
Presentation mode			
Speed data			
TT, AIS on/off			
TT, AIS track interval			
Vector mode			
Vector time			
VRM			
Range			
Reference Point			
A/C SEA			
A/C RAIN			
Auto Rain			
Gain			
Echo stretch			
Echo averaging			
IR			
Automatic Clutter Elimination (ACE)			
Picture setting (Customize echo)	Dependent control		Cannot control
Performance monitor			
SART			
STBY TX			
Tuning			
TT Lost alert	Common control	Item commonly controlled	Item commonly controlled
TT CPA/TCPA alert			
TT ALARM ACK			
TT acquire			
TT/AIS AZ			

2.29.3 How to select an antenna

For the ship that carries multiple antennas, you can select the antenna to use. Click the [Antenna] button to select the antenna.

2.29.4 How to revert to own antenna

To release the interswitch and revert to viewing the radar image from own antenna, right click the Antenna selection box on the Status bar, then select [Reset Antenna]. You are asked if you are sure to reset the antenna; click the [Yes] button to revert to own antenna.

2.30 Dual Radar

When installing two FAR-3xx0 series radars, the image from both radars (main radar and external radar) may be shown together on one radar display. This allows you to take advantage of the best characteristics each type of radar has to offer.

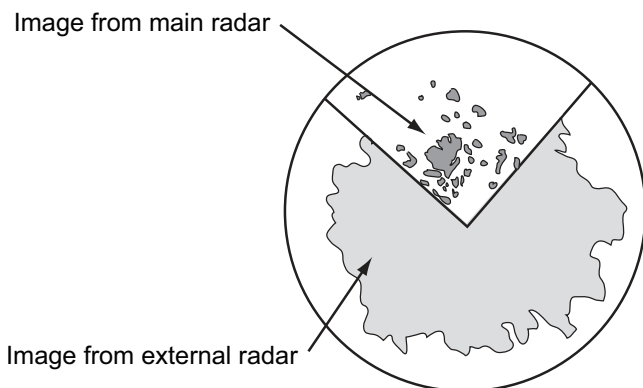

The following should be done from the [RADAR INSTALLATION] menu at the time of installation in order to enable the dual radar display:

- Set the display area on both the main radar and the external radar ([2 COMBINE SECTOR], [3 COMBINE RANGE]).
- Select the number of external radar to use ([4 EXT RADAR]).
- Turn the dual radar function on ([5 COMBINE FUNC] is set to [ON]).

TT information

When a TT target crosses over the boundary line of the display area, its information is passed to the other radar display. Tracking on the TT continues. The number of the antenna which acquires a TT target is displayed in front of the TT number.

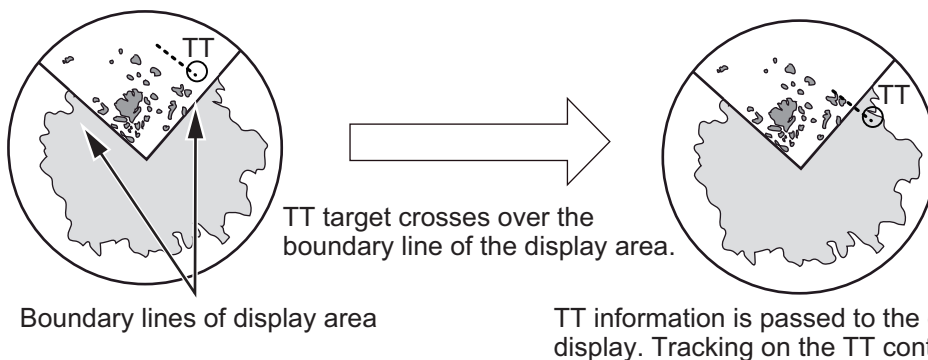

2.30.1 How to enable or disable the dual radar display

Turn on the power of main radar and external radar to set them in standby. The dual radar function is not available when one of two radars is in TX (transmit) state or turned off.

From the menu

1. Open the menu then select [1 ECHO] and [9 DUAL RADAR].
2. Select [COMBINE] to enable the dual radar display. To disable the dual radar display, select [OFF].
3. Close the menu.

From the antenna button

1. Right-click the [Antenna] button on the Status bar to show the context-sensitive menu.
2. Select [Dual Radar].
3. Select [Combine]. To disable the dual radar display, select [Off].

2.30.2 Operating considerations for the dual radar display

In the dual radar mode, you can operate the antenna displayed in the [Antenna] button on the Status bar. To operate the other antenna, select it in the [Antenna] button on the Status bar.

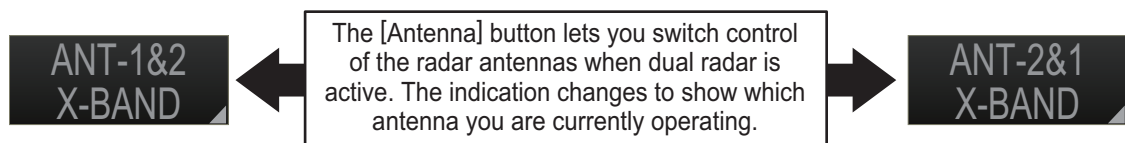

In the left-hand example, radar antenna no.1 is controlled; in the right-hand example, no.2 is controlled.

You can toggle each radar between standby and TX in the dual radar display. When switching to the standby mode, the Alert 730 (ALF format: 10740,1) "EXT Radar ST-BY" appears and the radar echoes are not displayed.

The following functions are based on the settings in the radar which enables the dual radar display. These settings are common with two radars.

- Off-center display
- Range scale
- Presentation mode
- Electronic chart on/off
- CU/TM reset
- Trail settings
- TT lost target filter

Notes

- The dual radar function is available between two FAR-3xx0 series radars using the LAN. FAR-2xx7, FAR-2xx8 and FCR-2xx9 are not available.
- When a transmission error occurs between two radars in the dual radar mode, the Alert 750 (ALF format: 10740,3) "EXT Radar COM Error" appears and the dual radar function is turned off.
- The dual radar display is not available on the external radar which overlays the main radar image even though the dual radar is turned on.
- If TT data (two places) are passed between two radars (see page 2-50), TT targets are lost in the external equipment using TT informations (TTM) of this equipment.

Restrictions

The followings are the restrictions of the dual radar function.

- A REF (reference) mark can be entered on the display of the main radar but not the external radar.
- TT targets can be acquired manually. [TT SELECT] is set to manual acquisition.
- The reference position is set to [CCRP] (see section 2.33). Set the same CCRP position between two radars at the time of installation.
- [ECHO AREA] is set to [CIRCLE] (see section 2.39).
- The following functions are not available in the dual radar mode.
 - Performance monitor
 - SART
 - Tune initialize
 - TT simulation mode
 - Icing prevention
 - Interswitch

2.31 Performance Monitor

The performance monitor, installed in the antenna unit, produces a visual indication on the radar display screen when the radar transmitter power and the radar receiver sensitivity and tuning are within the prescribed limits. A graph is also provided and it shows degradation of TX/RX/Power over time.

How to activate, deactivate the performance monitor

To activate, deactivate the performance monitor, do the following.

Note: Activate, deactivate the performance monitor in TX (transmit) state.

1. Set the radar in TX (transmit) state.
2. Open the menu then select the [1 ECHO] menu.
3. Select [6 PERFORMANCE MON].
4. Select [ON] or [GRAPH ONLY] as appropriate.
[ON]: Activate the performance monitor. The performance monitor graph is displayed.
[GRAPH ONLY]: Display the performance monitor graph. (The performance monitor is not executed.)
5. Select [0], [2], [3], [5] or [6] in [ARC] (see "How to set the number of arcs" on page 2-54).
6. Close the menu after 30 seconds.
7. When selecting [ON] or [GRAPH ONLY], the performance monitor graph is displayed in the information box.

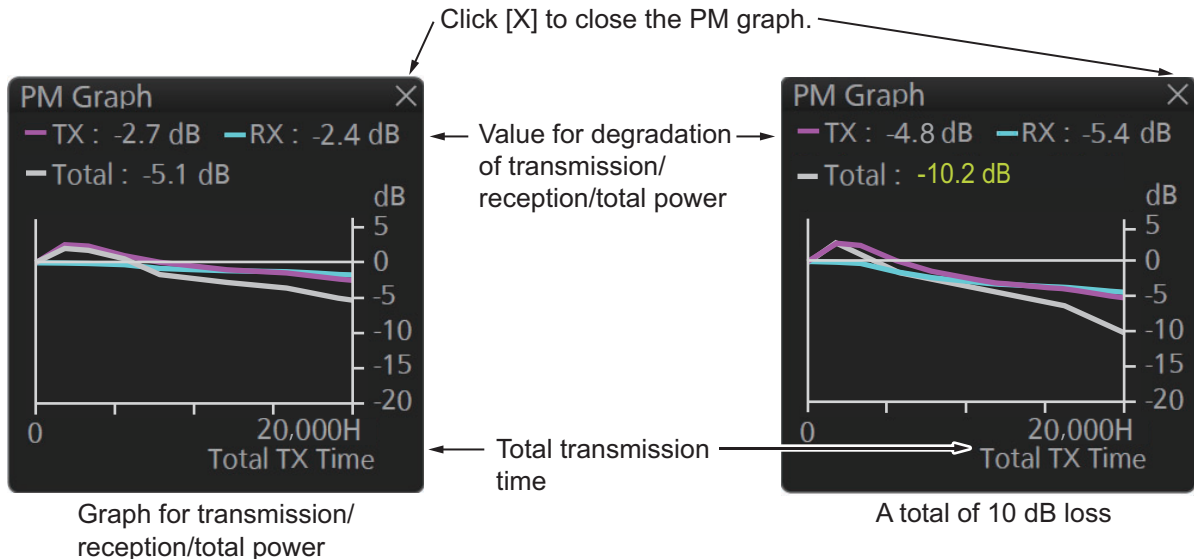

8. Open the menu then select the [1 ECHO] menu.
9. Select [6 PERFORMANCE MON].
10. Select [OFF] to deactivate the performance monitor.
11. Close the menu. The icon "PM" appears in the message area on the status bar (see subsection 1.8.1) when the performance monitor is active.

Note: If the blind sector and the direction of the PM antenna overlap one another, turn off the blind sector in order to display echoes correctly.

The radar is automatically set as follows when the performance monitor is activated.

2. RADAR, CHART RADAR OPERATION

Item	Setting at activation of PM	Adjustable while PM is active	Setting at deactivation of PM
CONDITION	Setting stored	No	Setting before activation
CUSTOMIZE ECHO	Grayed out, setting stored	No	Return to active display
EAV	OFF	No	Setting before activation
ES	OFF	No	Setting before activation
GAIN	70 * ¹	Yes* ³	Setting before activation
IR	OFF	No	Setting before activation
LOW LEVEL ECHO	Setting stored	No	Setting before activation
NOISE REJECT	OFF	No	Setting before activation
OFF center	OFF	Yes	Setting at deactivation
Presentation Mode	Setting stored * ²	Yes	Setting at deactivation
PULSE	LONG	No	Setting before activation
RAIN	0	No	Setting before activation
RAIN AUTO	MAN	No	Setting before activation
RANGE	24 NM, 24 SM, 48 km, 48 kyd	Yes * ⁴	Setting at deactivation
SEA	0	No	Setting before activation
SEA AUTO	MAN	No	Setting before activation
TUNE	AUTO	No	Setting before activation
VIDEO CONTRAST	4B* ⁵	No	Setting before activation
WIPER	OFF	No	Setting before activation

*¹ Gain is automatically set according to [PM GAIN ADJ] if it was adjusted at installation.

*² North-up RM is selected when the mode is North-up TM.

*³ The setting is not memorized.

*⁴ The performance monitor is deactivated if the range is changed.

*⁵ "ICE" video contrast setting is used when the ICE mode is active.

How to check radar performance

The range scale is automatically set to 24 NM. The radar screen will show arcs. You can set the number of arcs. If the radar transmitter and receiver are in good working order in as much as the original state when the monitor was turned on, the innermost arc should appear between 8.0 NM and 19.8 NM. The performance monitor can observe a total of 10 dB loss in the transmitter and receiver.

Note 1: The location of the arcs changes with the setting of [ARC].

Note 2: When [ARC] (the number of arcs) is set to [0] (see "How to set the number of arcs" below), there are no arc indications. Only the performance monitor graph is displayed in the information box.

How to set the number of arcs

1. Open the menu then select the [1 ECHO] menu. Select [6 PERFORMANCE MON].

2. Select [0], [2], [3], [5] or [6] in [ARC].
3. Close the menu.

Note: The lengths and location of the arcs may change with the direction in which the antenna unit is installed. Judge the strength of the echo that appears within 60° from arc location to confirm if the radar is working properly or not.

Turn off the performance monitor when finished.

The following illustrations in the table are the examples when [ARC] is set to [5].

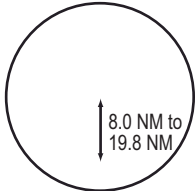
Display	Transmitter, receiver state
	<p>Transmitter: Normal Receiver: Normal</p>
	<p>Transmitter and receiver: No arc indicates 10 dB loss. Contact your dealer for advice. (For a magnetron radar, have a technician check the magnetron.)</p>

Note: The location of the arcs changes with the setting of [ARC].

2.32 Magnetron Reset (For A- and B-types)

After replacing the magnetron for the antenna unit, reset the TX time then adjust the PM gain as follows:

1. Open the menu then select [8 INITIAL SETTING].
2. Select [9 MAGNETRON RESET].
3. Select [1 TX TIME] then set the transmit time to 000000.0H.
4. Select [2 PM GAIN ADJ].
5. Select [AUTO] or [MANUAL].
[AUTO]: PM gain is automatically adjusted. Go to step 7.
[MANUAL]: Set PM gain manually. Go to step 6.
6. Adjust the PM gain manually as follows:

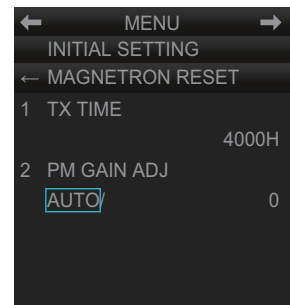

Note: If the blind sector and the direction of the PM antenna overlap one another, turn off the blind sector before adjusting the PM gain.

- 1) Set the radar settings as follows:
 - Range: 24 NM
 - Pulse Length: Long
 - A/C SEA: OFF (turn off manually)
 - A/C RAIN: OFF (turn off manually)
 - Echo Averaging (EAV): OFF
 - Video Contrast: 2-B
- 2) Adjust the gain so that a slight amount of white noise appears on the screen. Arcs for the performance monitor appear on the screen.

2. RADAR, CHART RADAR OPERATION

- 3) Set [PM GAIN ADJ] so that the outer arc faintly appears. The setting range is 0 to 255. Wait at least eight scans then adjust. The following illustration is an example when [ARC] is set to [5] (see "How to set the number of arcs" on page 2-54).

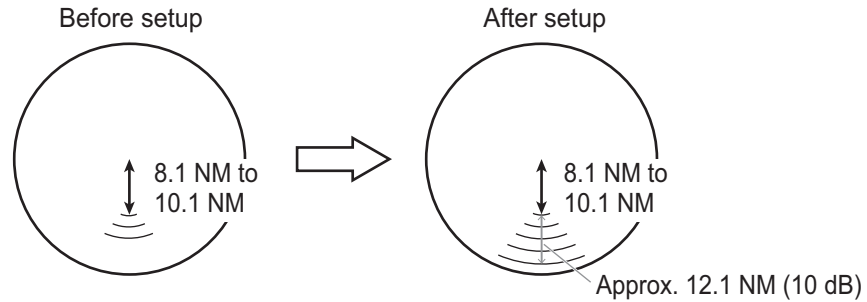

Note: The location of the arcs changes with the setting of [ARC].

7. Close the menu.

2.33 CCRP (Common Consistent Reference Point)

The reference position for measurements (range, bearing, etc.) and markers (heading line, stern mark, etc.) can be the antenna position or CCRP, which is a location on own ship to which all horizontal measurements, for example range, bearing, relative course, relative speed, closest point of approach (CPA) or time to closest point of approach (TCPA), are normally referenced.

To select the reference position, click the button below [REF point] at the top-left position to select [ANT] or [CCRP] as appropriate.



Click button to switch

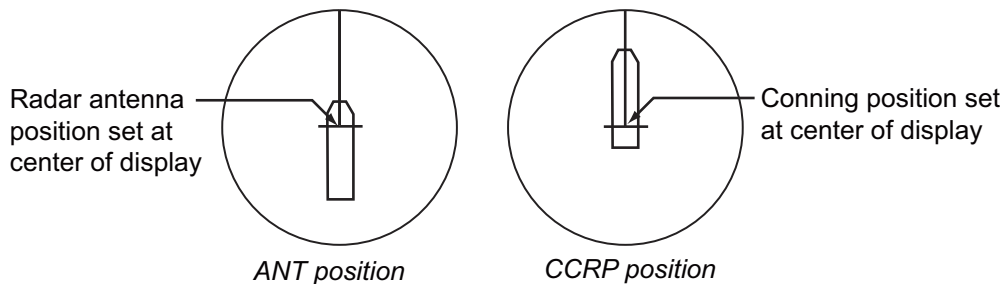

The position of the own ship marker changes according to reference position as above. If the CCRP is positioned outside of the effective display area, the bearing scale is indicated with the appropriate reduced detail.

Range and bearing are measured and graphics are drawn according to reference point as shown in the table below.

Category	Item	Reference point	
		CCRP	Antenna position
Range and bearing measurement	EBL	Range and bearing measured from CCRP	Range and bearing measured from antenna position
	VRM		
	Cursor		
	PI line		
	Range ring		
	Drop mark		
Graphics	Heading line	Drawn from CCRP	Drawn from antenna position
	Stern mark		
	Beam line		
	Own ship vector		
	Own ship track		
Bearing cursor		Drawn with CCRP at center	Drawn with antenna position at center
Course, speed		Calculated with CCRP at center	Calculated with antenna position at center
CPA, TCPA		Calculated with CCRP at center	Calculated with antenna position at center
BCR, BCT		Calculated from bow position	
Own ship data	Heading	Data from sensor, regardless of reference point selected	
	Speed		
	Course over ground		
	Speed over ground		
	Own L/L	Location of the CCRP	

2.34 Drop Mark

The drop mark is used to find the angle and distance from a point to your ship. This can be useful for marking a point to avoid while navigating to a destination. The drop marks can be shown or hidden on the screen.

The Drop mark box shows the angle and distance between the drop mark and your ship.

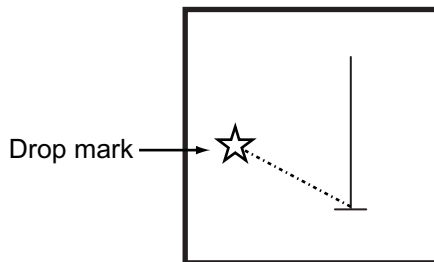

Note: The drop mark feature is inoperative when position data is lost.

2.34.1 How to show, hide the drop mark box

The drop mark box can be shown or hidden by trackball.

OFF: Click the arrow on the [Drop mark] box or right-click the box and select [DROPx Off] (x=Drop mark no.).

ON: Click the minimize box.

2.34.2 How to inscribe a drop mark

Click the desired Drop mark box at the bottom of the screen. Click a position on the display area where to put a drop mark, and a drop mark is inscribed at the position selected. The angle and distance to the point appear in the corresponding Drop mark box.

2.34.3 Drop mark bearing reference

The bearing of a drop mark is automatically referenced to True or Relative according to the presentation mode.

Presentation mode	Bearing reference
Head-up RM	Relative
STAB H UP RM	
Stern-up RM	
Course-up RM	True
North-up RM	
North-up TM	

2.34.4 How to erase a drop mark

Erase drop mark from menu

1. Open the menu then select the [5 MAP•MARK] and [1 MARK SETTING] menus.
2. Select [7 DROP MARK].
3. Select [ON] or [OFF].
4. Close the menu.

Erase drop mark by trackball

Right-click the applicable Drop mark box to show the context-sensitive menu then select [Drop1 Off] (or [Drop2 Off]). The drop mark and its data are erased.

2.35 Anchor Watch

The anchor watch is used to monitor if the ship is staying at anchor. If your vessel travels more than the distance set here, the Alert 495 (ALF format: 10802) "Anchor Watch" appears in the [Alert] box and the audio alarm sounds.

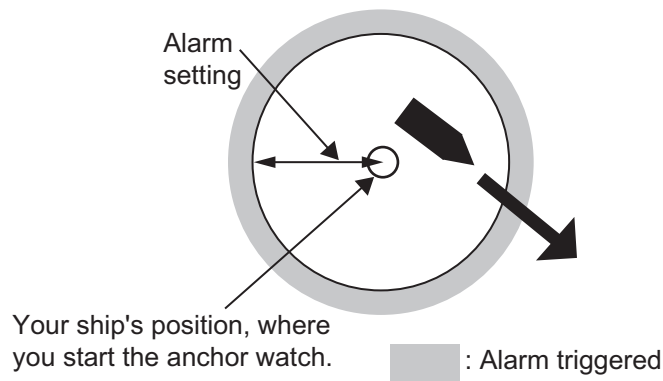

How to activate anchor watch

1. Open the menu then select [8 INITIAL SETTING] and [4 ALERT] menus.
2. Select [2 ANCHOR WATCH].
3. Select [ON]. Use the scrollwheel to set the alarm radius (0.01 to 9.99 NM).
4. Close the menu.



2.36 SART

2.36.1 What is an SART?

A Search and Rescue Transponder (SART) may be triggered by any X-band (3 cm) radar within a range of approximately 8 NM. Each radar pulse received causes it to transmit a response which is swept repetitively across the complete radar frequency band.

Screen A: When SART is distant

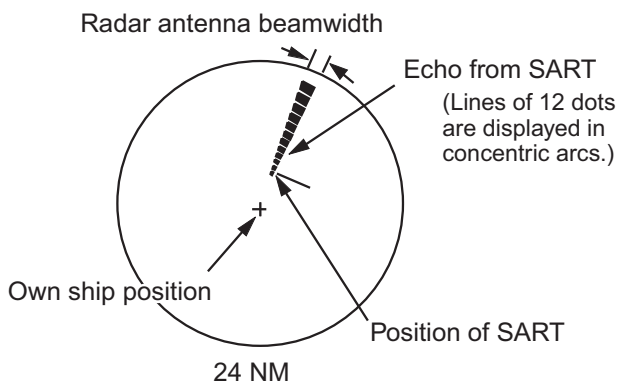

Screen B: When SART is close

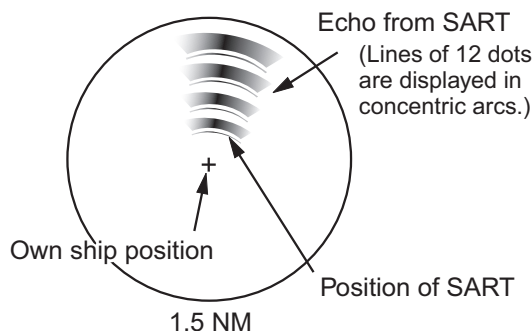

2.36.2 How to receive an SART

This radar is equipped with a feature that optimally sets up the radar for SART detection. This feature automatically detunes the radar receiver out of its best tuning condition. This erases or weakens all normal radar echoes, but the SART marks are not erased because the SART response signal scans over all frequencies in the 9 GHz band. When the radar approaches the SART in operation, the SART marks will enlarge to large arcs, blurring a large part of the screen.

Note: The SART function is not available with solid state radars other than FAR-3220-NXT/FAR-3220-NXT-BB/ FAR-3320-NXT.

1. Open the menu then select the [1 ECHO] menu.
2. Select [7 SART].
3. Select [ON].
4. Close the menu. The icon “SART” appears in the Message area on the status bar (see subsection 1.8.1) when the SART function is active.

When the SART is activated the radar controls are automatically set as follows.

Item	Setting at activation of SART feature	Adjustable during activation of SART feature	Setting at deactivation of SART feature
CONDITION	Setting stored	Yes	Setting at deactivation
CUSTOMIZE ECHO	Grayed out, setting stored	No	Return to active display
EAV	OFF	No	Setting before activation
ES	OFF	No	Setting before activation
GAIN	Setting stored	Yes	Setting at deactivation
IR	OFF	No	Setting before activation

Item	Setting at activation of SART feature	Adjustable during activation of SART feature	Setting at deactivation of SART feature
LOW LEVEL ECHO	Setting stored	Yes	Setting at deactivation
NOISE REJECT	OFF	No	Setting before activation
OFF center	OFF* ³	Yes	Setting at deactivation
Presentation Mode	Setting stored * ¹	Yes	Setting at deactivation
PULSE	LONG	No	Setting at deactivation
RAIN	Setting stored	Yes	Setting at deactivation
RAIN AUTO	MAN	No	Setting before activation
RANGE* ⁴	12 NM, 12 SM, 24 km, 24 kyd	Yes * ²	Setting at deactivation
SEA	Setting stored	Yes	Setting at deactivation
SEA AUTO	Setting stored	Yes	Setting at deactivation
TUNE	Setting stored	Yes	Setting at deactivation
VIDEO CONTRAST	Setting stored	Yes	Setting at deactivation
WIPER	Setting stored	Yes	Setting at deactivation

*1. North-up RM selected when the mode is North-up TM.

*2. For radars other than FAR-3220-NXT/FAR-3220-NXT-BB/ FAR-3320-NXT, the SART feature is deactivated if the range is changed.

*3. For models FAR-3220-NXT/FAR-3220-NXT-BB/ FAR-3320-NXT, the OFF-CENTER setting used when SART is activated is retained.

*4. For models FAR-3220-NXT/FAR-3220-NXT-BB/ FAR-3320-NXT, range at SART activation is 24 NM, 24 SM, 32 km, 48 kyd. Ranges below these are selectable, however pulselength is fixed at the highest pulselength available for the selected range.

2.37 Doppler Feature (X-band Solid State Radars only)

The doppler feature is available only for FAR-3220-NXT, FAR-3220-NXT-BB and FAR-3320-NXT. This feature is designed to further reduce clutter or noise.

To use the doppler feature, do the following:

1. Open the menu, then select [1 ECHO].
2. Select [NEXT], then [3 DOPPLER].
3. Select the appropriate setting, referring to the list below:
 - [0]: disables the doppler feature.
 - [1]: reduces noise, making weak targets easier to find.
 - [2]: reduces clutter from rain, etc., making it easier to find targets previously hidden by clutter.
4. Close the menu.

2.38 Alert Box, Alert List

2.38.1 Alert box

When an alert condition is found, the applicable alert message and alert ID appear in the [Alert] box. For the alarm- and warning-type alerts a buzzer sounds. The [Alert] box is composed of the four items shown in the figure below. See chapter 20 for details.

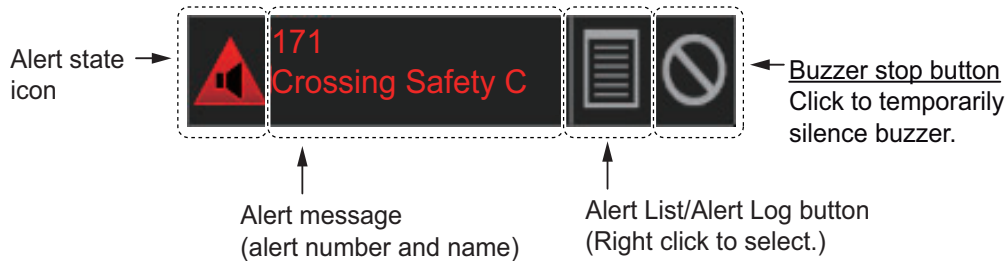

2.38.2 Alert list

The [Alert List] displays the status of the latest 900 system alerts, in order of generation, latest to the earliest. To display the list, click the Alert list/log icon in the [Alert] box. The Alert list/log icon is light-blue when the list is displayed. A maximum of nine alerts are shown per page. Unacknowledged alerts are displayed in flashing red (alarm) or flashing yellow-orange (warning). The ZDA sentence is required to display time in the list.

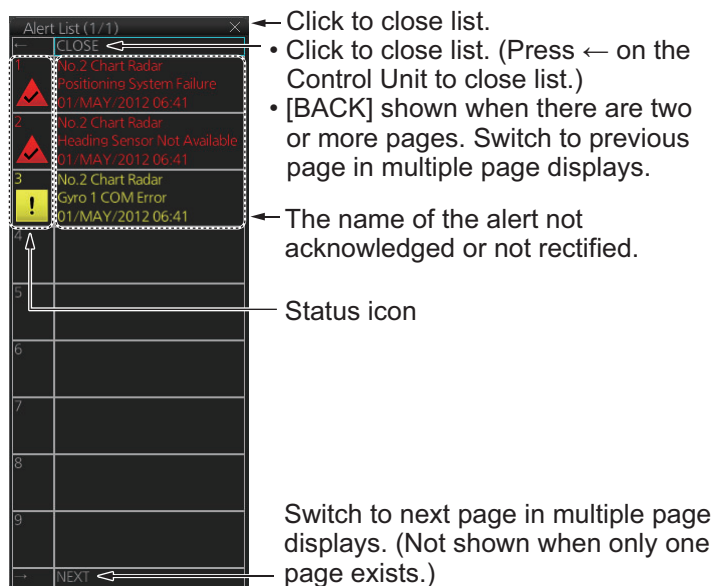

How to acknowledge or rectify from the list

Control Unit: Press appropriate numeric key.

Trackball module: Click alarm name.

How to find details about an alert

Click the status icon in the list to show details about an alert.

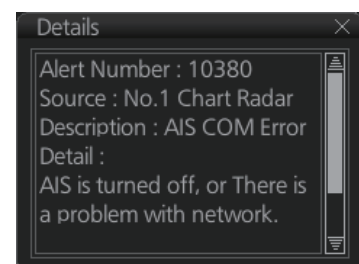

2.39 Echo Area

The echo display area for the B-type radar can be selected for [CIRCLE] or [WIDE].

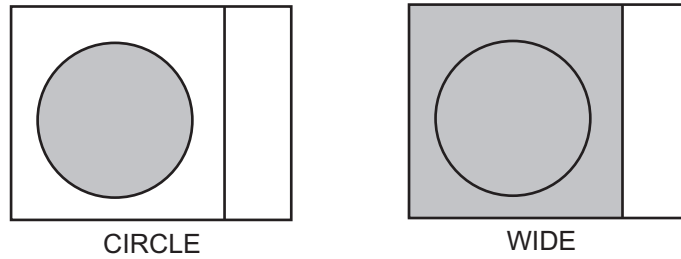

To select the echo display area type to use, open the menu, select the [1 ECHO] menu then set [2 ECHO AREA] to [CIRCLE] or [WIDE] as appropriate.

2.40 Echo Color

The default echo color is yellow. Echo color is also available in the following colors:

B type: Yellow, green, white, amber, and “color”. “Color” displays echoes in red, yellow or green corresponding to the signal levels of strong, medium and weak.

IMO and A types: Yellow, green and white.

To select the echo color, open the [1 ECHO] menu then select desired color from [3 ECHO COLOR].

2.41 Icing Prevention

You can rotate the antenna (24 rpm) without transmission to keep the antenna from freezing.

1. Open the menu then select the [8 INITIAL SETTING] menu. Select [0 ICING PREVENTION].
2. Select [ON]. The following message appears at the bottom of the screen.

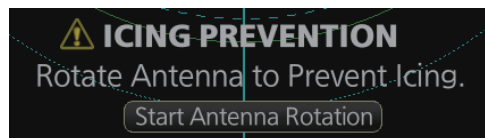

3. Click [Start Antenna Rotation] to rotate the antenna without transmission. The message changes as follow.

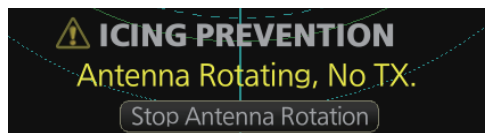

2. RADAR, CHART RADAR OPERATION

To stop the antenna rotation, click [Stop Antenna Rotation].

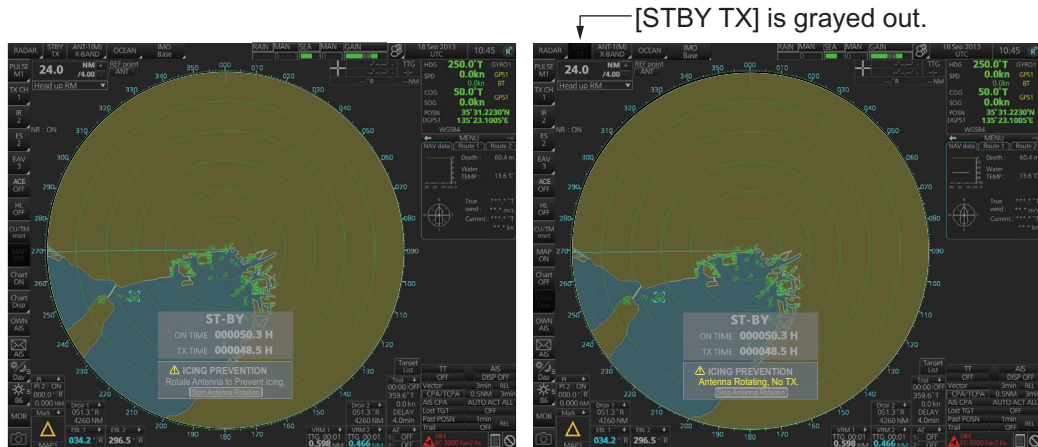

When the antenna stops

When the antenna rotates

With this feature active and the antenna stopped, pushing the **STBY TX** key on the Control Unit or click the [STBY TX] button on the Status bar rotates the antenna and transmits pulses. Operating one of the above-mentioned controls again stops transmission but the antenna rotates.

2.42 Shuttle Ferry

The shuttle ferry feature changes the screen orientation by 180°. This feature requires an external switch (local supply).

There are two variations: Standard display ([SHUTTLE FERRY] is turned OFF) and reversed display ([SHUTTLE FERRY] is set for [MODE1] or [MODE2]).

Note 1: Have a FURUNO dealer or representative install the necessary external switch.

Note 2: The shuttle ferry feature requires gyro data. The feature is disabled when gyro data is lost.

When the display is reversed the following is done:

- Radar echoes are rotated 180°.
- Bearing for speed data is corrected by 180°.
- Wind direction based on speed input is corrected by 180°.
- With [MODE 2] active, the gyro value is corrected by 180°.

Note: [MODE 1] uses externally corrected gyro data, therefore gyro data is not re-calibrated.

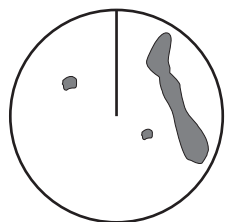

Normal display
Gyro input is displayed normally.

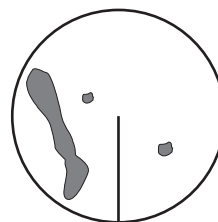

Reversed display
Gyro input is displayed 180° opposite to normal.

To activate or deactivate the shuttle ferry mode do as follows:

1. Open the menu then select the [8 INITIAL SETTING] menu.
2. Select [NEXT (1/2→2/2)].
3. Select [2 SHUTTLE FERRY] and the mode desired.
 [OFF]: Deactivate the shuttle ferry mode.
 [MODE1]: Activate the shuttle ferry mode. Gyro data is not re-calibrated 180° opposite to normal.
 [MODE2]: Activate the shuttle ferry mode. Gyro data is re-calibrated 180° opposite to normal.
4. Close the menu.

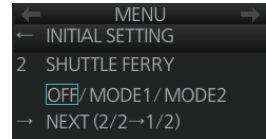

When the shuttle ferry feature is active, the indication [Reverse] appears at top left corner on the display.



2.43 Chart Radar Functions

2.43.1 How to switch between radar and chart radar modes

Click the [CHART ON/OFF] button on the InstantAccess bar™ to show or hide the chart.

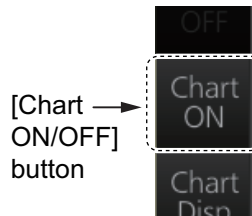

Indication on button and corresponding mode

[Chart ON]: Chart radar mode active. (Chart and radar picture are displayed.)

[Chart OFF]: Radar mode active. (Only the radar picture is displayed.)

When the GPS position is lost, the chart radar mode cannot be used. When this occurs, the label on the button shows [Chart OFF] and the button is grayed out.

2.43.2 How to show or hide chart objects

The [Chart Disp] button on the InstantAccess bar™ has several buttons which control chart object visibility.

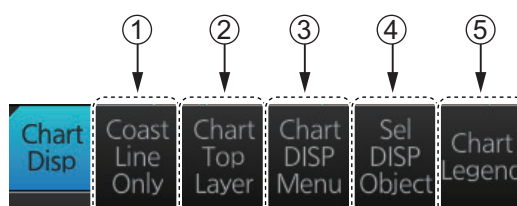

2. RADAR, CHART RADAR OPERATION

No.	Item	Function
1	[Coast Line Only]	Hold down the left button to temporarily display only the coastline. Chart symbols (depth contours, navigation buoys, etc.) are temporarily erased from the screen.
2	[Chart Top Layer]	Hold down the left button to temporarily put the chart objects (buoy, lighthouse, etc.) on the top layer.
3	[Chart DISP Menu]	Show the [CHART DISPLAY] menu, where you set safety contours, safety depth, etc. See the figure on the next page for the content of this menu and see section 8.2 "How to Control Visibility of Chart Objects" for details. Note: This menu can also be shown by right-clicking the [CHART ON/OFF] button and selecting [Chart Display Menu].
4	[Sel DISP Object]	Show the [SEL DISPLAY OBJECT] menu, where you can select the chart objects and text to show or hide. See the next page for the menus and see section 8.3 "How to Control Visibility of Symbols, Features" (symbol display) for details.
5	[Chart Legend]	Show the chart information for your current position, with your vessel at the center. See chapter 9 and chapter 10 for a description of the chart legends.

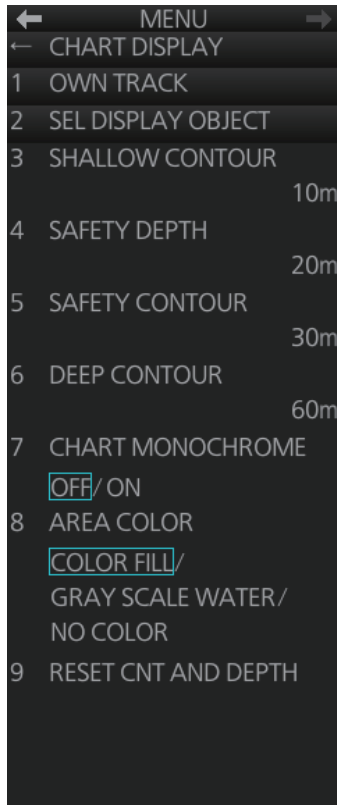
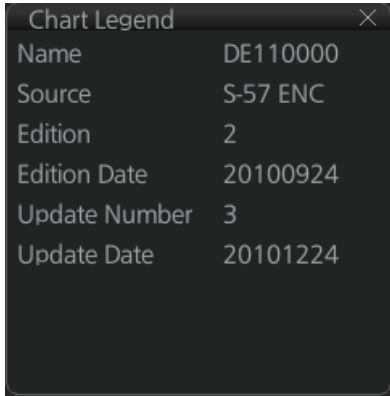
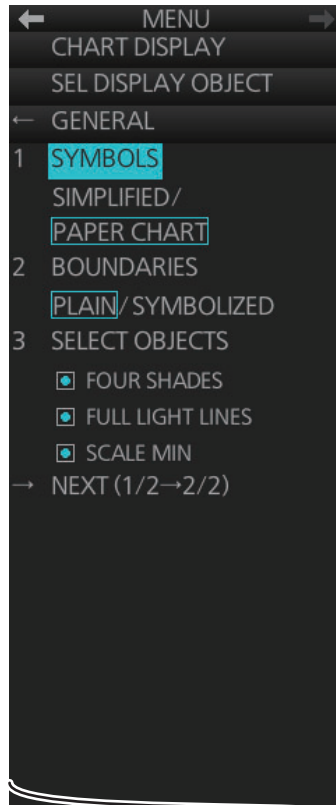
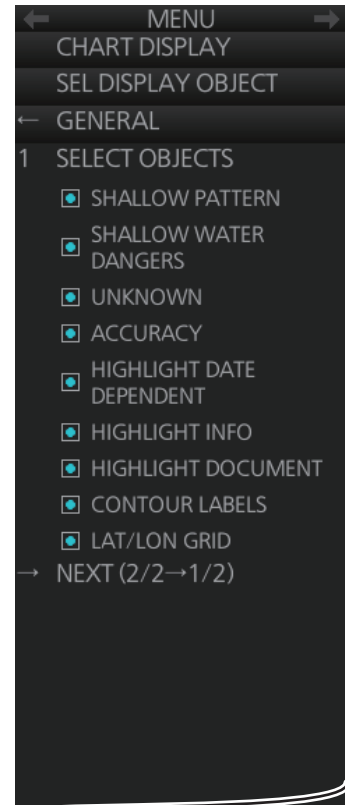
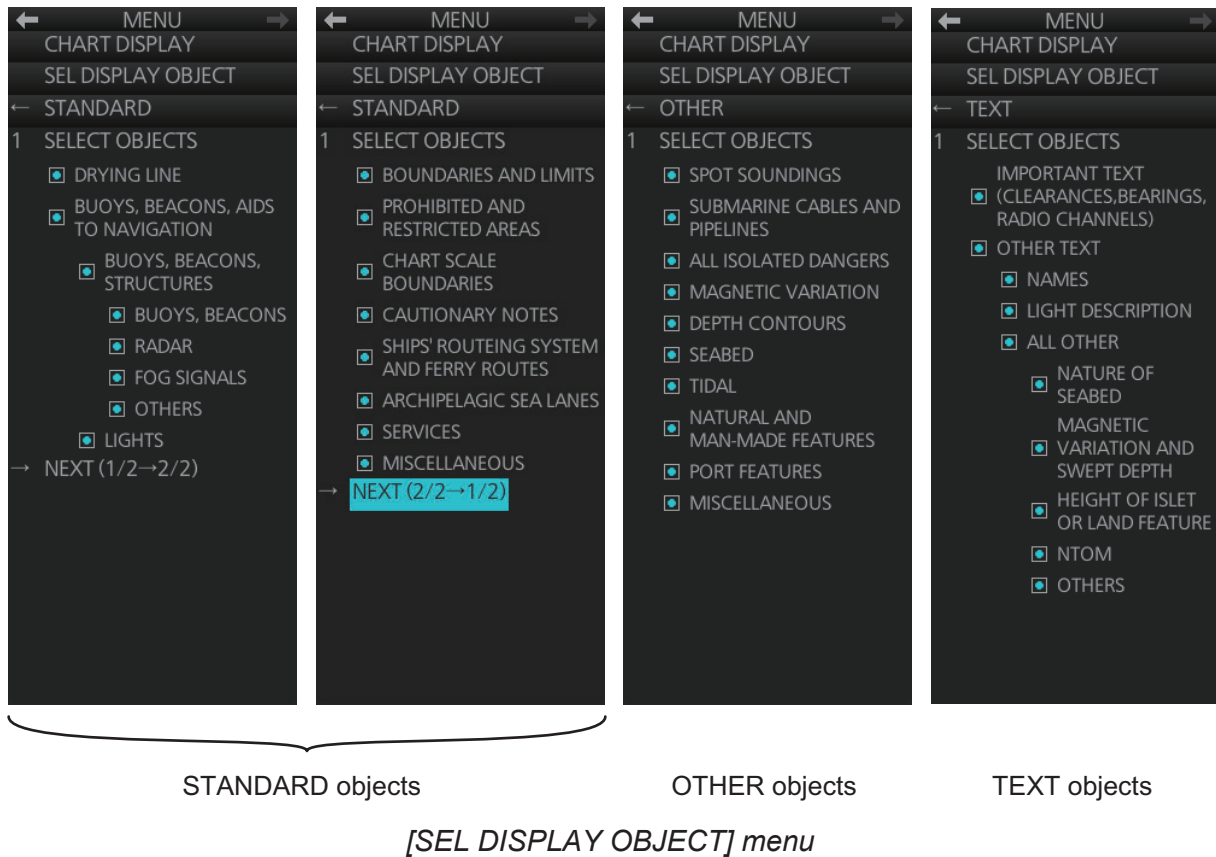

CHART DISPLAY menu



GENERAL menu





2.43.3 How to create and recall custom sets of chart display objects

You can create one custom set of chart display objects and recall them when required. For example, you can create a custom set of chart display objects to display when you navigate a certain coastline.

How to create a custom set of chart display objects







1. Open the menu then select the [6 CHART DISPLAY] and [2 SEL DISPLAY OBJECT] menus.
2. Open the [2 STANDARD ITEMS], [3 OTHER ITEMS], [4 IMPORTANT TEXT] and [5 OTHER TEXT] menus and turn objects and text on or off as appropriate.
3. Click [SEL DISPLAY OBJECT] on the menu.
4. Select [1 SAVE TO PERSONAL] to save the settings. The confirmation message "Attention: Do you wish to overwrite current settings to PERSONAL?" appears.
5. Click the [OK] button to save the settings.

How to activate the custom set of chart display objects

Click the [Chart database] button (see subsection 2.43.4) on the Status bar then select [PERSONAL].

2.43.4 Chart database information

You can select the quantity of objects and text to display on the chart radar screen, with the [Chart database] button on the Status bar. There are four different pre-defined settings available and one user-definable ([PERSONAL]). Indication of selected setting appears on the label of the [Chart database] button. The [Chart ON/OFF] button (on the InstantAccess bar™) must be ON to show the [Chart database] button. The [Chart database] button is grayed out if the [Chart ON/OFF] button is OFF.

[Chart database] button	Selection	Setting in [SEL DISP OBJECT] menu
	[IMO Base]	Nothing checked in [GENERAL], [STANDARD], [OTHER] or [TEXT].
	[IMO Primary]	Nothing else checked but [BUOYS AND BEACONS] in [STANDARD] and [SHALLOW WATER DANGERS] in [GENERAL]. This is the "Primary Chart Information Set (PCIS)", based on IEC 62388 Ed.2 section 12.1.5.1, IEC61174 and IMO Resolution MSC.232(82).
	[IMO Standard]	All objects checked in [STANDARD]; nothing checked in [GENERAL], [OTHER] or [TEXT].
	[IMO All]	Everything checked in [STANDARD] and [OTHER].
	[PERSONAL]	Use the settings recorded for [GENERAL], [STANDARD], [OTHER] and [TEXT].
		

2.43.5 How to set value for shallow contour, safety depth, safety contour and deep contour

You can set values for shallow contour, safety depth, safety contour and deep contour, on the [CHART DISPLAY] menu. Colors used for depth presentation on the electronic chart are controlled by setting values for shallow contour, safety depth, safety contour and deep contour. Soundings on the electronic chart, which are equal to or less than the value of safety depth, are highlighted. For details, see the ECDIS operator's manual.

Note: The shallow contour cannot be set higher than the safety contour.

1. Open the menu then select the [6 CHART DISPLAY] menu.
2. Select [3 SHALLOW CONTOUR], [4 SAFETY DEPTH], [5 SAFETY CONTOUR], or [6 DEEP CONTOUR].
3. Spin the scrollwheel to set the value then push the left button.
4. Close the menu.

To reset the value for shallow contour, safety depth, safety contour and deep contour, open the menu then select [6 CHART DISPLAY] and [9 RESET CNT AND DEPTH] menus. The message "Do you wish to restore default contour and depth settings?" appears. Select [Yes].

2.43.6 How to select the chart color and tone

You can select color and tone for chart display.

1. Open the menu then select the [6 CHART DISPLAY] menu.
2. Select [7 CHART MONOCHROME].
3. Select [OFF] or [ON] as appropriate.
[OFF]: Displays the chart in multicolor.
[ON]: Displays the chart in monochrome.
4. Select [8 AREA COLOR].
5. Select [COLOR FILL], [GRAY SCALE], or [NO COLOR] as appropriate.
[COLOR FILL]: Displays chart in multi color.
[GRAY SCALE]: Displays water area in gray scale.
[NO COLOR]: Does not fill the chart.
6. Close the menu.

2.43.7 Chart scale indications

The system alerts you to the availability of larger scale ENC and overscale, at the top-left position.

When the radar display range is higher than the chart scale of the ENC chart, the indication, "Larger scale ENC" is displayed. For example, the radar range is 24 NM and the range available with the ENC chart is less than 12 NM.

When the radar display range is lower than the chart scale of the ENC chart, the indication "Overscale x.xx" (x.xx=overscale factor). For example, the radar range is 0.25 NM and the chart scale is 0.5 NM.

If both conditions exist, both indications are displayed.

Location of chart scale indications



2.43.8 Chart status

The indication "Chart Status" appears at the top-right position on the screen when the display date for the currently displayed chart has passed.

2.43.9 Chart alert function

The chart alert function operates in chart mode only. There are two types of chart alerts: your ship's predicted course, and route alert. See chapter 11 for details.

For the ship's predicted course alert, the operator sets a safety contour. (See subsection 8.2.1 for how to set a safety contour suitable for the ship.) The operator also sets the parameters for own ship predicted movement. (See section 11.2 "How to Activate Own Ship Look-ahead Area".)

For the route alert, route planning (see section 12.4 "How to Create a New Route") and route monitoring (see section 14.1 "How to Start Route Monitoring") functions are available.

2.43.10 Notes details

"Notes" provides messages for the operator relative to a specific ship position. The chart radar compares the Notes position and own ship position and displays the Notes when own ship is at the distance from the Notes specified in route planning. To display the Notes at other times, right-click the display area to show the context-sensitive menu, then select [Notes Detail]. In the example below, the Notes about a wreck are shown.

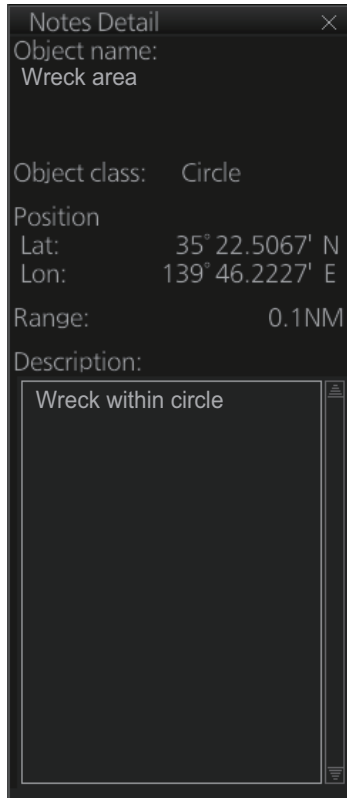

- [Object name]: The name assigned to the Notes.
- [Object class]: The type of object (point, line, area or circle) linked to the Notes.
- [Position]: Position of the object in latitude and longitude.
- [Range]: The range to the object.
- [Description]: A description of the object, input in the Voyage planning mode.

2.44 Radar Observation

2.44.1 General

Minimum range

The minimum range is defined by the shortest distance at which, using a scale of 1.5 or 0.75 NM, a target having an echoing area of 10 m² is still shown separate from the point representing the antenna position.

It is mainly dependent on the pulse length, antenna height, and signal processing such as main bang suppression and digital quantization. It is a good practice to use a shorter range scale as far as it gives favorable definition or clarity of picture. The IMO Resolution MSC.192(79) requires the minimum range to be less than 40 m, respectively. This series of radars satisfy this requirement.

Maximum range

The maximum detecting range of the radar, radar horizon, varies considerably depending on several factors such as the height of the antenna above the waterline, the height of the target above the sea, the size, shape and material of the target, and the atmospheric conditions.

Under normal atmospheric conditions, the maximum range is equal to the radar horizon or a little shorter. The radar horizon is longer than the optical one by about 6% because of the diffraction property of the radar signal. The radar horizon is given in the following equation.

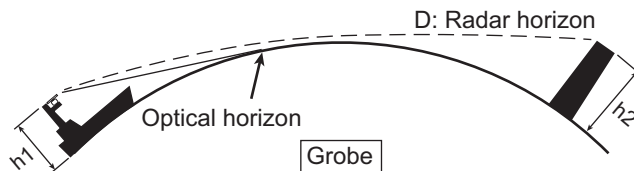

$$D = 2.2 \times (\sqrt{h_1} + \sqrt{h_2})$$

where D: radar horizon (nautical miles)

h_1 : antenna height (m)

h_2 : target height (m)

For example, if the height of the antenna above the waterline is 9 meters and the height of the target is 16 meters, the maximum radar range is;

$$D = 2.2 \times (\sqrt{9} + \sqrt{16}) = 2.2 \times (3 + 4) = 15.4 \text{ NM}$$

It should be noted that the detection range is reduced by precipitation (which absorbs the radar signal).

X-band and S-band

In fair weather, the equation on the previous page does not give a significant difference between X- and S-band radars. However, in heavy precipitation condition, an S-band radar would have better detection than an X-band radar.

Radar resolution

There are two important factors in radar resolution (discrimination): bearing resolution and range resolution.

2. RADAR, CHART RADAR OPERATION

Bearing resolution

Bearing resolution is the ability of the radar to display as separate pips the echoes received from two targets which are at the same range and close together. It is proportional to the antenna length and reciprocally proportional to the wavelength. The length of the antenna radiator should be chosen for a bearing resolution better than 2.5° (IMO Resolution). This condition is normally satisfied with a radiator of 1.2 m (4 ft) or longer in the X-band. The S-band radar requires a radiator of about 12 feet (3.6 m) or longer.

Range resolution

Range resolution is the ability to display as separate pips the echoes received from two targets which are on the same bearing and close to each other. This is determined by pulse length only. Practically, a 0.08 microsecond pulse offers the discrimination better than 40 m as do so with all FURUNO radars. Test targets for determining the range and bearing resolution are radar reflectors having an echoing area of 10 m^2 (X-band) or 1 m^2 (S-band).

Bearing accuracy

One of the most important features of the radar is how accurately the bearing of a target can be measured. The accuracy of bearing measurement basically depends on the narrowness of the radar beam. However, the bearing is usually taken relative to the ship's heading, and thus, proper adjustment of the heading line at installation is an important factor in ensuring bearing accuracy. To minimize error when measuring the bearing of a target, put the target echo at the extreme position on the screen by selecting a suitable range.

2.44.2 False echoes

Occasionally echo signals appear on the screen at positions where there is no target or disappear even if there are targets. They are, however, recognized if you understand the reason why they are displayed. Typical false echoes are shown below.

Multiple echoes

Multiple echoes occur when a transmitted pulse returns from a solid object like a large ship, bridge, or breakwater. A second, a third or more echoes may be observed on the display at double, triple or other multiples of the actual range of the target as shown below. Multiple reflection echoes can be reduced and often removed by decreasing the gain (sensitivity) or properly adjusting the sea clutter.

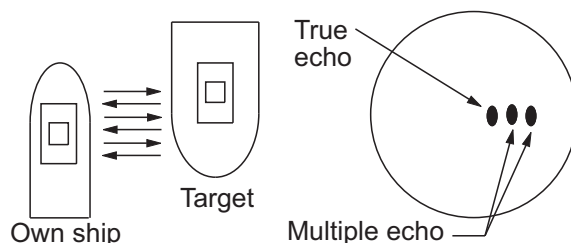

Sidelobe echoes

Every time the radar pulse is transmitted, some radiation escapes on each side of the beam, called "sidelobes." If a target exists where it can be detected by the side lobes as well as the main lobe, the side echoes may be represented on both sides of the true echo at the same range. Side lobes show usually only on short ranges and from strong targets. They can be reduced through careful reduction of the gain or sea clutter.

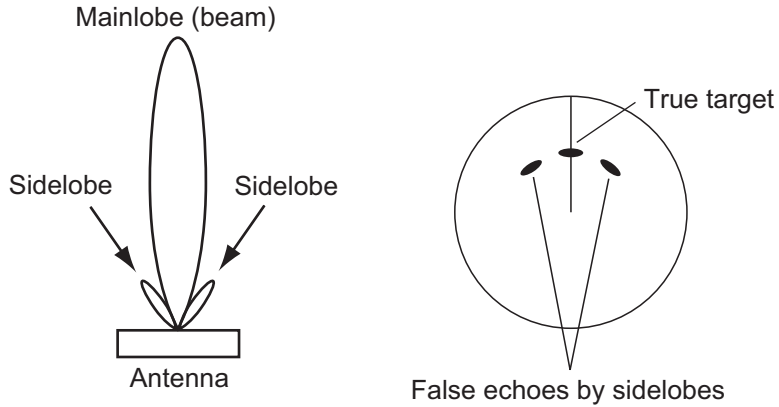

Virtual image

A relatively large target close to your ship may be represented at two positions on the screen. One of them is the true echo directly reflected by the target and the other is a false echo which is caused by the mirror effect of a large object on or close to your ship as shown in the figure below. If your ship comes close to a large metal bridge, for example, such a false echo may temporarily be seen on the screen.

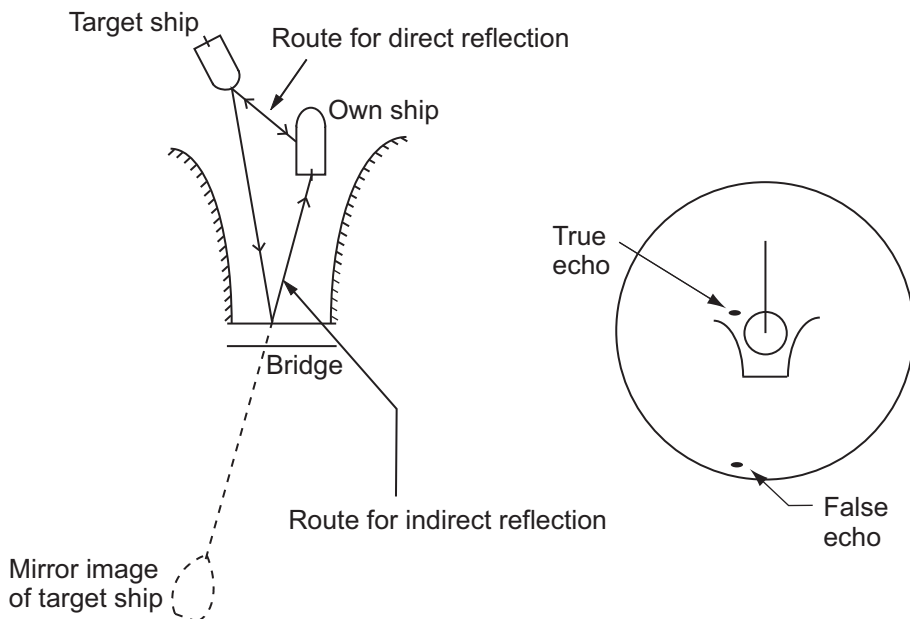

2. RADAR, CHART RADAR OPERATION

Shadow sectors

Funnels, stacks, masts, or derricks in the path of the antenna block the radar beam. If the angle subtended at the antenna is more than a few degrees, a non-detecting sector may be produced. Within this sector targets can not be detected.

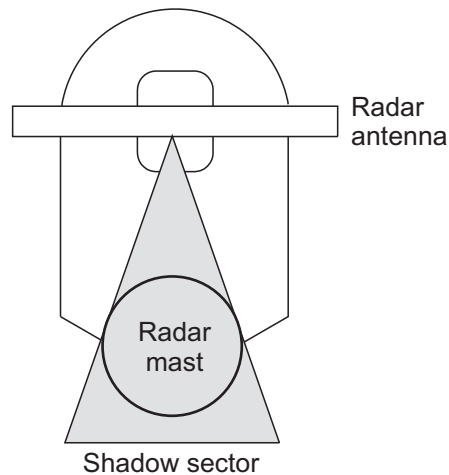

2.44.3 RACON

A RACON is a radar beacon which emits radar receivable signals in the radar frequency spectrum (X- or S-band). There are several signal formats; in general, the RACON signal appears on the radar screen as a rectangular echo originating at a point just beyond the position of the radar beacon. It has a Morse coded pattern. Note that the position on the radar display is not accurate.

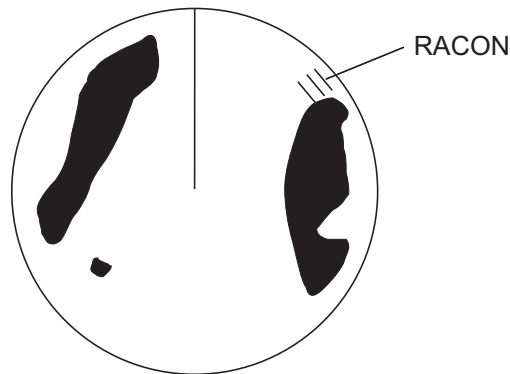

2.44.4 Radar Target Enhancer (RTE)

An RTE is a radar transponder that is mounted on navigation buoys and masts of small crafts to significantly improve their detection by radar. Unlike a SART or RACON, which are passive, the RTE receives a radar signal, amplifies it and re-transmits it, with the intention of making the target's signal look larger on a radar display. The RTE can be detected on both X-band and S-band radars.

2.44.5 Solid state radar

In Solid State radars, long-range and short-range pictures are mixed before they are displayed on the screen. Due to this mixing process, echoes may be displayed differently when compared with magnetron radars.

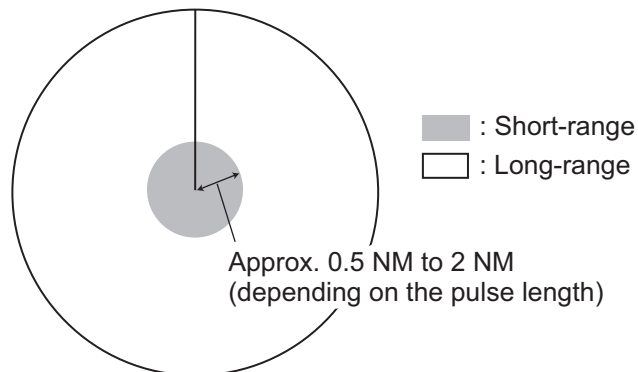

Range and signal intensity

At long-range, even though the Solid State radar has lower transmission power than magnetron radars, the signal intensity is equivalent.

At short-range on the other hand, due to the lower transmission power the signal intensity of closer targets (including sea clutter and rain clutter) is reduced.

For this reason, when a long-range target enters short-range the signal intensity appears weaker.

Range sidelobe

As a result of pulse compression, range sidelobes may appear to the front and rear of a strong reflected echo. When the direction of the echo changes, the reflection weakens and the range sidelobes may disappear. Range sidelobes can also be removed by reducing the gain.

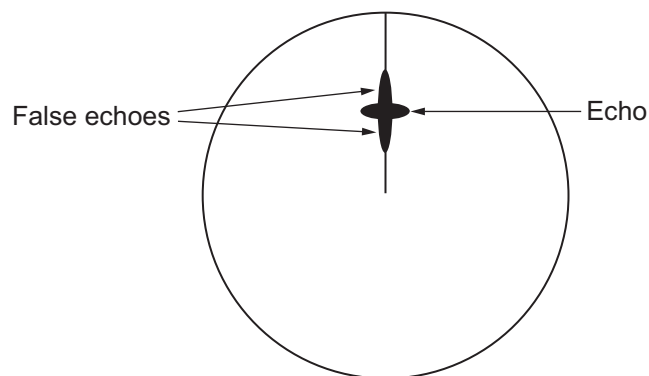

2. RADAR, CHART RADAR OPERATION

This page is intentionally left blank.

3. TARGET TRACKING (TT)

3.1 About TT

The TT tracks and plots the movement of up to 200 radar targets and fully complies with IMO standards for TT.

The TT automatically tracks an automatically or manually acquired radar target and calculates its course and speed, indicating them with a vector. Since the data generated by the TT depends on the radar targets selected, the radar must be optimally tuned for use with the TT, to ensure required targets will not be lost or unnecessary targets like sea returns and noise will not be acquired and tracked.

Tracking accuracy is affected by course change. One to two minutes is required to restore vectors to full accuracy after an abrupt course change. (The actual amount depends on gyrocompass specifications.)

The amount of tracking delay is inversely proportional to the relative speed of the target. Delay is approx. 15-30 seconds for the higher relative speed; approx. 30-60 seconds for the lower relative speed. The following factors can affect accuracy:

- Echo intensity
- Radar transmission pulse length
- Radar bearing error
- Gyrocompass error
- Course change (own ship and targets)

3.2 How to Show, Hide the TT Display

Click the TT mode indication at the bottom-right position to show [OFF] to hide the TT display, or [AUTO]*, [MAN]* or [MAN/AUTO]* to show the TT display. You can right-click the TT mode indication to show a context-sensitive menu with the choices shown above. In this case, click the applicable option.

* The indication shown depends on the setting of [TT SELECT] in the [TT•AIS] menu.

TT	AIS	
OFF	DISP ALL	
Vector	20min	True-G
CPA/TCPA	0.5NM	3min
AIS CPA	AUTO ACT ALL	
Lost TGT	ALL	
Past POSN	OFF	True-G
Trail	OFF	

3.3 How to Input Your Ship's Speed

The TT requires own ship's speed and heading data. The speed can be STW, SOG, or echo-referenced speed (based on 3 max. stationary objects) taken from this radar. Manual input is also possible.

For automatic or manual speed input, see section 1.16. For echo-referenced speed input see the next section.

3.3.1 Echo-referenced speed input

The use of echo-referenced speed is recommended when:

- The speed log is not operating properly or not connected to the radar.
- The vessel has no device that can measure ship's leeward movement (doppler sonar, speed log, etc.) when leeward movement cannot be disregarded.

If you select echo-referenced speed, the TT calculates own ship's speed relative to a fixed reference target. The number of targets may be 1, 2 or 3. They appear as tracked targets, each denoted with a small circle. When a plural number of objects are selected, the mean value is used.

Note: This feature is not available when the AIS is active.

1. Right-click the display area to show the context-sensitive menu then select [REF Mark].
2. Select a small fixed island or any radar prominent point located at 0.1 to 24 NM from own ship.
3. Use the trackball to put the cursor (+) on the target selected at step 2.
4. Push the left button to insert the reference mark.

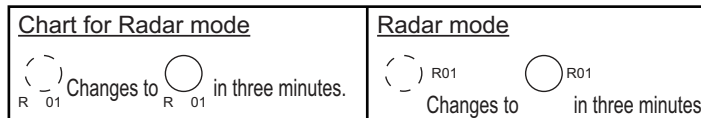

5. Repeat steps 2-4 to continue entering reference marks. Three may be entered.
6. Right click the Sensor information, datum box then select [Select Sensor] and [Setting]. Open the [SPD] page and put a checkmark at [Reference SPD]. Click the [OK] button to finish.

Notes on speed input by reference target

- Reference targets are only used for the calculation of true speed.
- Do not use reference target generated true speed to calculate relative speed. Relative speed data is not accurate because response to speed change is slow, hampering the TT's ability to accurately judge the possibility of collision.
- Select a stationary target as a reference target to calculate own ship speed as ground tracking speed. Do not choose a moving target as a reference target. A moving target produces error in the vector for TT and AIS, which results in wrong collision avoidance information. Further, an unstable stationary target produces inaccurate speed data and the target itself may become lost.
- When a reference target is lost or goes out of the acquisition range, the reference target mark flashes and the Alert 528 (ALF format: 193,2) "REF Target Lost" appears in the [Alert] box. If all reference targets are lost, the speed indication disappears. Select a different reference target if the currently selected one is lost.

- When all tracked targets are deleted, the reference target mark is also deleted and the target-based speed becomes invalid.
- Loss of reference target will affect the calculation of true speed and true course of targets. Further, own ship speed will be inaccurate.

How to cancel echo-referenced speed input

Right click the Sensor information, datum box then select [Select Sensor] and [Setting]. Open the [SPD] page and select a speed sensor.

3.4 Automatic Acquisition

This radar can automatically acquire and track a maximum of 200 targets. The maximum number of acquired targets ([NUMBER OF TT]) is set at the time of installation. The options are 200 ([MAX]) and 100.

The number of automatically and manually acquired targets is determined by the setting of [TT SELECT] in the [TT] menu.

A target just acquired automatically is marked with a dashed circle and a vector appears within one minute to indicate the target's motion trend. Within three minutes, the initial tracking stage is finished and the target becomes ready for stable tracking. At this time, the dashed circle changes to a solid circle.

Note: When connecting with an FAR-2xx7 or FAR-2xx8 series radar, the maximum number of acquired targets ([NUMBER OF TT]) should be set to 100 in the [RADAR INSTALLATION] menu. The service man only can set the [RADAR INSTALLATION] menu. Contact your dealer.

3.4.1 How to enable auto acquisition

1. Right-click the TT mode indication then select [TT Menu] to show the [TT] menu.
2. Select [1 TT SELECT] and the acquisition condition.

[NUMBER OF TT] is [MAX]		[NUMBER OF TT] is [100]	
Menu setting	Acquisition condition	Menu setting	Acquisition condition
[MANUAL 200]	200 targets manually, Not available for auto acquisition	[MANUAL 100]	100 targets manually, Not available for auto acquisition
[MANUAL 150 • AUTO 50]	50 targets automatically, 150 targets manually	[MANUAL 75 • AUTO 25]	25 targets automatically, 75 targets manually
[MANUAL 100 • AUTO 100]	100 targets automatically, 100 targets manually	[MANUAL 50 • AUTO 50]	50 targets automatically, 50 targets manually
[MANUAL 50 • AUTO 150]	150 targets automatically, 50 targets manually	[MANUAL 25 • AUTO 75]	75 targets automatically, 25 targets manually
[AUTO 200]	200 targets automatically, Not available for manual acquisition	[AUTO 100]	100 targets automatically, Not available for manual acquisition

3. Close the menu.

Note 1: The TT indication in the TT/AIS setting box shows [AUTO], [MAN/AUTO] or [MAN] depending on the acquisition condition selected.

3. TARGET TRACKING (TT)

Note 2: When the menu-set number of automatically acquired targets have been acquired, the Alert 523 (ALF format: 190,4) "TT Auto ACQ 100%" appears in the [Alert] box.

3.4.2 How to set an automatic acquisition zone

You can set an automatic acquisition zone to automatically track any targets entering the zone. The acquisition zone can be fan-shaped or polygonal. The maximum tracking range is set during the installation.

Fan-shaped zone of AZ1: The range is fixed at 3 - 6 NM (width 0.5 - 1.0 NM).

Fan-shaped zone of AZ2: The range is available between 0.7 - 24 (or 32) NM (width 0.5 - 1.0 NM)

Polygon zone of AZ2: The zone can be set within the range of 0.125 NM to 96 NM.

Note: When processing two acquisition zones, create the zones in numerical order and turn them off in reverse numerical order.



← To set the zone for AZ2, first set the zone for AZ1.

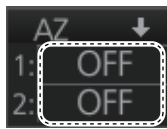

← To turn off the zone for AZ1, first turn off the zone for AZ2.

When a target enters an acquisition zone, the following occurs:

- the buzzer sounds
- the Alert 521 (ALF format: 192,1) "TT New Target" appears in the [Alert] box
- the symbol of the target is red and flashes
- the AIS function is automatically turned on if it is off

1. Click one of the boxes AZ1 or AZ2 at the right side of the screen. The indication in the AZ box changes from [OFF] to [SET].



2. Click point A.
3. Click point B. The indication in the AZ box changes from [SET] to [WORK].

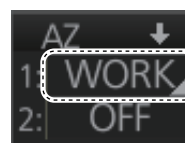
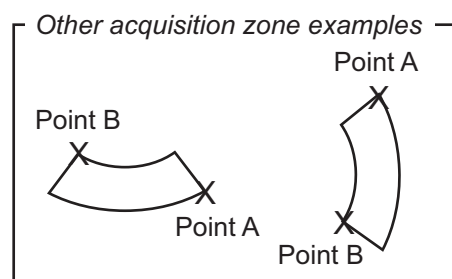
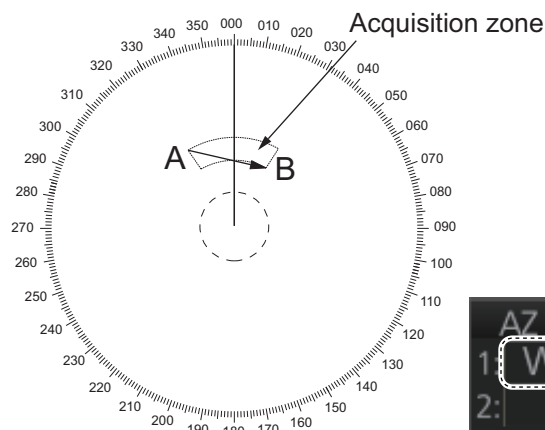

Note 1: You are alerted when the capacity for automatic acquisition is 95% and 100%. These alerts are 522 (ALF format: 10190,4) "TT Auto ACQ 95%" and 523 (ALF format: 190,4) "TT Auto ACQ 100%".

Note 2: If the range scale is changed to less than half of the acquisition zone, the AZ box shows [OUT]. If the left button is pushed in this state, the acquisition alarm zone goes into [SLEEP] state (inactive).

How to sleep, deactivate an acquisition zone

Use the trackball to select the appropriate AZ box. Sleep or deactivate the acquisition zone as appropriate:

Sleep acquisition zone: Push the left button momentarily to remove the acquisition zone from the screen. The indication in the AZ box changes from [WORK] to [SLEEP]. To reactivate and display the acquisition zone, repeat this procedure to display [WORK].

Deactivate acquisition zone: Click applicable AZ box and select [OFF].

How to acknowledge the acquisition zone audio alarm

Press the **ALARM ACK** key, or click the [Alert] box.

Acquisition zone stabilization

The acquisition zone may be referenced to heading or North. Open the menu then select the [TT•AIS] and [1 ACQUISITION ZONE] menus. Set [1 AZ STAB] to [STAB HDG] or [STAB NORTH] as appropriate. For a polygon acquisition zone, stabilization can be selected to [2 AZ POLYGON].

3.5 Manual Acquisition

This radar can manually acquire and track a maximum of 200 targets. The maximum number of acquired targets ([NUMBER OF TT]) is set at the time of installation. The options are 200 ([MAX]) and 100.

The number of automatically and manually acquired targets is determined by the setting of [TT SELECT] in the [TT] menu.

Note: When connecting with an FAR-2xx7 or FAR-2xx8 series radar, the maximum number of acquired targets ([NUMBER OF TT]) should be set to 100 in the [RADAR INSTALLATION] menu. The service man only can set the [RADAR INSTALLATION] menu. Contact your dealer.

3.5.1 How to set manual acquisition conditions

1. Right-click the TT mode indication then select [TT Menu] to show the [TT] menu.
2. Select [1 TT SELECT] and the acquisition condition.

[NUMBER OF TT] is [MAX]		[NUMBER OF TT] is [100]	
Menu setting	Acquisition condition	Menu setting	Acquisition condition
[MANUAL 200]	200 targets manually, Not available for auto acquisition	[MANUAL 100]	100 targets manually, Not available for auto acquisition
[MANUAL 150 • AUTO 50]	50 targets automatically, 150 targets manually	[MANUAL 75 • AUTO 25]	25 targets automatically, 75 targets manually

3. TARGET TRACKING (TT)

[NUMBER OF TT] is [MAX]		[NUMBER OF TT] is [100]	
[MANUAL 100 • AUTO 100]	100 targets automatically, 100 targets manually	[MANUAL 50 • AUTO 50]	50 targets automatically, 50 targets manually
[MANUAL 50 • AUTO 150]	150 targets automatically, 50 targets manually	[MANUAL 25 • AUTO 75]	75 targets automatically, 25 targets manually
[AUTO 200]	200 targets automatically, Not available for manual acquisition	[AUTO 100]	100 targets automatically, Not available for manual acquisition

3. Close the menu.

3.5.2 How to manually acquire a target

Acquire a target from the Control Unit

Use the trackball to put the cursor on the target you want to acquire. Push the **ACQ/ACT** key.

Acquire a target by the trackball module

1. When the target to acquire and the AIS symbol overlap one another, push the right button to show the context-sensitive menu then select [Target Data/ACQ/ACT] and [TT Only] to acquire the target.
2. Put the cursor on the target to acquire then push the left button.

The plotting symbol is drawn by a dashed circle during the initial acquisition stage. A vector appears approximately one minute after acquisition. The vector indicates the motion trend of the target. If the target is consistently detected for three minutes, the plotting symbol changes to a solid circle. If acquisition fails, the target symbol blinks.

Note 1: For successful acquisition, the target should be within 24 NM (or 32 NM, depending on initial setting) from own ship and not obscured by sea or rain clutter.

Note 2: You are alerted when the capacity of manual acquisition is 95% and 100%. These alerts are Alert 524 (ALF format: 10190,5) "TT MAN ACQ 95%" and Alert 525 (ALF format: 190,5) "TT MAN ACQ 100%". If the capacity is 100% you cannot acquire more targets. Cancel tracking of non-threatening targets if you wish to acquire additional targets manually.

Note 3: When a target being tracked nears another target being tracked, the targets may be "swapped". When two targets acquired either automatically or manually come close to each other, one of the two may become a lost target. If this occurs, manual re-acquisition of the lost target may be necessary after the two have separated.

Note 4: You can reuse a target number. This is useful when you acquire the "wrong" target. Drag and drop the symbol onto the correct target.

3.6 How to Stop Tracking Targets (including reference targets)

When the TT has acquired the menu-set number of targets, the Alert 523 (ALF format: 190,5) "TT AUTO ACQ 100%" (automatic acquisition) or 525 (ALF format: 190,4) "TT MAN ACQ 100%" (manual acquisition) appears in the [Alert] box and no more auto or manual acquisition occurs unless targets are lost. Should this happen, cancel tracking of less important targets to acquire new targets.

3.6.1 How to cancel tracking on individual tracked targets

Cancel tracking on a target from the Control Unit

1. Use the trackball to put the cursor (+) on the TT or reference target to cancel tracking.
2. Push the **TARGET CANCEL** key.

Cancel tracking on a target by the trackball module

1. Right-click the operational area of the screen to show the context-sensitive menu.
2. Select [Target Cancel] and [Any] or [TT Only] as applicable.
3. Click the TT or reference target to cancel tracking.

3.6.2 How to cancel tracking on all TTs

Cancel tracking on all target from the menu

1. Right-click the TT mode indication on the bottom-right of the screen then select [TT Menu] to show the [TT] menu.
2. Select [2 ALL CANCEL].
3. Select [YES].
4. Close the menu.



Cancel tracking on all target from the Control Unit

Long-press the **TARGET CANCEL** key to erase all displayed TT target data.









3.7 TT Symbols and TT Symbol Attributes

3.7.1 TT symbols

The symbols used in this equipment comply with IEC 62288.

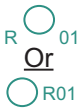
Symbol	Default color	Name	Description
	Green	Past position marker	Past position point
	Green	Target under acquisition	Plotting symbol selected for a target acquired manually is shown in broken lines.

3. TARGET TRACKING (TT)

Symbol	Default color	Name	Description
	Red	Target under auto- matic acquisition	Thick, broken circle around an echo to indicate the target under acquisition and initial stage of tracking, before steady-state tracking.
	Green	Acquired target	Solid circle with vector indicating steady state tracking (within three minutes after acquisition)
	Red	Acquired target in ACQ zone (before acknowledgment)	Solid circle with vector indicating steady state tracking (within three minutes after acquisition)
	Red	Dangerous target	Dangerous TT (thick, solid circle)
	Green	Reference target	Used to calculate own ship's over- the-ground speed (echo-refer- enced speed) for ground stabliza- tion.
	Green	Association target	Association TT is shown in AIS symbol and TT data.
	Red	Association danger- ous target	Association dangerous TT is shown in AIS symbol and TT data.
	Red	Lost target	Lost TT is shown with cross mark.
	Green	Target selected	TT selected to show its data.
T	White	Trial maneuver	Displayed (flashing) during trial maneuver test.
S	White	TT test	Displayed (flashing) during TT test.

3.7.2 TT symbol brilliance

1. Right-click the [BRILL] button on the InstantAccess bar™ then select [Brill Menu].
2. Go to page 2, select [4 TT SYMBOL] then spin the scrollwheel to adjust the brilliance.

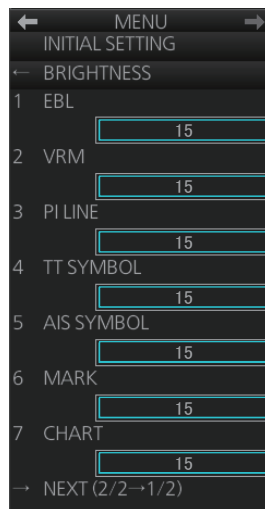

3.7.3 Color for TT symbol

You can select the color for the TT symbol as follows:

1. Right-click the TT mode indication then select [Symbol Menu] to show that menu.

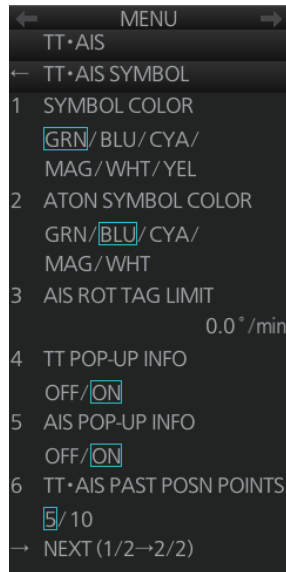

2. Select [1 SYMBOL COLOR] and desired color. (Yellow is available with the A- and B-type.)

3.8 How to Display TT Data

The TT mode provides the full functionality of TT as required by the IMO MSC.192(79) and IEC 62288, including display of range, bearing, course, speed, CPA and TCPA of all tracked targets.

The target bearing is show in relative bearing in the head-up mode and true bearing in the course-up, north-up and true motion modes, with the suffix "R" (Relative) or "T" (True).

The target speed and course are shown as speed over the ground or speed through the water depending on speed source.

3.8.1 How to display target data for individual TT

You can show the data for two (19-inch display) or three (23-inch display) tracked targets in the TT information window.

From the Control Unit

Put the cursor on a target then push the **TARGET DATA** key.

By trackball module

Click the target for which you want to show its data.

Tracked target data

- To erase data from a data box, click the appropriate close data button.
- The basic target data display for a TT consists of the following information:
 - TT no. Target numbering starts from "1". When a target is erased the number will not be reused until the power is re-set or more than 200 targets are acquired.
 - Bearing (BRG) and distance (RNG) of the target from own ship
 - True speed over the ground (SOG) and true course over the ground (COG) of the target
 - CPA and TCPA. A negative TCPA value means that you have already passed the closest point and the TT is going away from own ship.
 - Bow Crossing Range (BCR) and Bow Crossing Time (BCT)

Title bar →	TT		↔	↓	↑	✕
TT no. →	001	✕	002	✕		
Bearing →	BRG	137.0° T	138.5° T			
Range →	RNG	8.587NM	8.726NM			
Course over ground →	T COG	040.0° T	062.5° T			
Speed over ground →	T SOG	9.81kn	7.35kn			
CPA →	CPA	5.724NM	5.847NM			
TCPA →	TCPA	-33:24	-35:48			
Bow crossing range →	BCR	-7.171NM	-7.326NM			
Bow crossing time →	BCT	-12:05	-13:03			

Number of TT/AIS target data box to display

You can select how many target data boxes to display with the following procedure.

1. Open the menu, then select [4 INFORMATION BOX] and [4 TARGET DATA].
2. Select the number of boxes to display from [1 BOX], [2 BOX], or [3 BOX].
Note: The [3 BOX] option is not available for 19 inch monitors.
3. Close the menu.

The target data are displayed from bottom up in order of acquisition. When target data box(es), information box and zoom display are available, target data box(es) has priority.

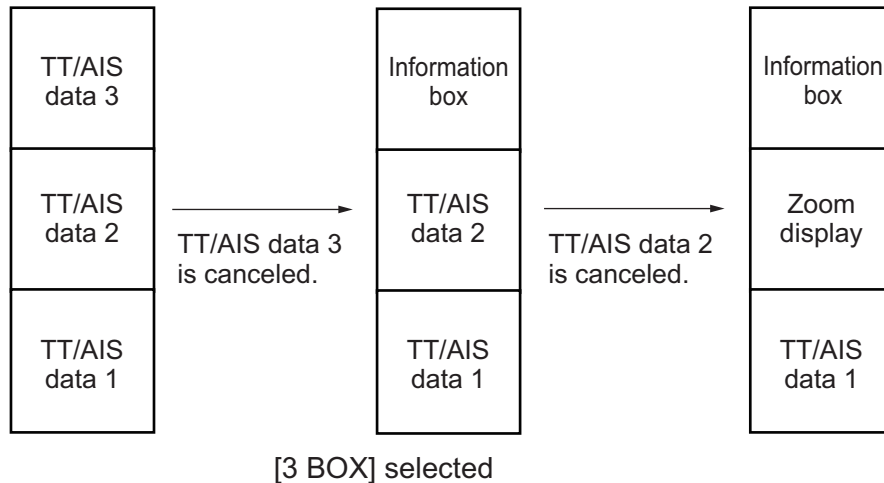
**3.8.2 TT pop-up information**

The TT pop-up shows abbreviated TT data (target no., target name*, COG, SOG, CPA and TCPA) for the selected TT. Simply put the cursor on the TT symbol to show the pop-up. The pop-up can be enabled or disabled with [TT POP-UP INFO] in the [TT•AIS SYMBOL] menu.

*: The target name feature is available for B-type radars only. See section 3.17.

```

TT(01)
FURUNO
COG: 228.1° T
SOG: 46.40kn
CPA: 0.959NM
TCPA: 01:31

```

3. TARGET TRACKING (TT)

3.8.3 Target list

The target list shows the data for all tracked targets and AIS targets. To show the list, click the [Target List] button at the right side of the screen or press the **TARGET LIST** key on the Control Unit. (The button is light-blue when the target list is displayed.)

To close the list, click the Close button (X) on the list or press the **TARGET LIST** key.

Filter targets: →

Sort targets by: →

CPA
TCPA
BCR
BCT
RANGE
SPEED
NAME

TT target name: Appears only on B-types and only when a name is set.

Click to refresh data →

[INFO] column: Click to show/hide the target information for each target. The information displayed varies depending on the target selected.

- For AIS targets: The order in which the targets appear in the details window is displayed (A, B or C). For example, a target with the indication “B” in the [INFO] column appears in the second target details box.
- “C” is not shown for 19” monitors.
- For TT targets: The target number (01 to 200) appears.
- For reference targets: The reference number (R01 to R03) appears.

How to sort the list

You can sort the list by CPA, TCPA, BCR, BCT, RANGE, SPEED or NAME, with the [Sort by] drop-down list.

How to filter the list

The list shows all tracked targets and AIS targets received. If you do not need to see all targets you can filter unnecessary ones. Use the [Filter] drop-down list to select what targets to filter: Show all targets, TT only, AIS targets only, or show only the AIS targets that meet the criteria set on the [DISP FILTER] menu.

3.9 Vector Modes

Target vectors can be displayed relative to own ship's heading (Relative) or North (True).

Note: IMO recommends the use of the true vector mode in sea stabilization or relative vector mode for collision avoidance.

3.9.1 Description of vectors

Stabilization modes

It is important to select the optimum stabilization mode for the radar display. To assess risk of collision the relative motion of a target gives the clearest indication of CPA and may be monitored by observing either the direction of the target's relative trail, or the CPA predicted by the relative vector. By default, relative motion displays relative target trails and true motion displays true target trails. Where true target trails is selected, a sea stabilized display will indicate all targets' motion through the water. A ground stabilized display will indicate all targets' motion over the ground.

In coastal, estuarial and river waters where a significant set and drift may be experienced, a sea stabilized display will produce significant target trails from all fixed (stationary) objects possibly producing an unacceptably high level of clutter and masking. In such circumstances a ground stabilized display may reduce its effect and enable the observer to detect clearly the trails of moving targets, thus enhancing the observer's situational awareness.

However, the display should be considered only as an approximation of the course and speed made good over the ground. Among other factors, the accuracy of the ground-stabilization is affected by inaccuracies in speed and heading inputs as well as radar measurement imprecision and will require the display to be readjusted periodically. The information displayed should be interpreted with due regard to these factors.

Note: It should be noted that in determining a target's aspect by radar; the calculation of its true track is dependent on the choice and accuracy of the own ship's course and speed input. A ground-stabilized target plot may accurately calculate the ground track of the target, but the target's heading may be significantly different from its track when experiencing set, drift or leeway. Similarly, a sea stabilized target plot may be inaccurate when own ship and the target, are experiencing different rates of set, drift or leeway.

Ground stabilization and sea stabilization

Target vectors can be ground stabilized or sea stabilized. To select speed over the ground or speed through the water data, open the page from the menu. Select for ground stabilization or for sea stabilization. The Vector mode indication shows the stabilization mode in the true motion as [True-G] or [True-S].

Sea stabilization is a mode where own ship and all targets are referenced to the sea using a compass heading and single-axis log water speed inputs in the true motion mode. Ground stabilization is a mode where own ship and all targets are referenced to the ground using the ground track or set and drift inputs. If the accuracy seems unsatisfactory, enter set and drift corrections. Note that set and drift should not be used when the radar is displaying AIS targets.

3. TARGET TRACKING (TT)

True vector

In the true motion mode, all fixed targets such as land, navigational marks and ships at anchor remain stationary on the radar screen with vector length zero. But in the presence of wind and/or current, the vectors appear on fixed targets representing the reciprocal of set and drift affecting own ship unless set and drift values are properly entered.

In the true vector mode, there are two types of stabilization: ground stabilization (True-G) and sea stabilization (True-S). The stabilization mode is automatically selected according to speed selection, as shown in the table below. Manual selection is available with [Stabilization Mode] in the [SPD] page in the [Sensor Settings] menu.

Speed selection	True vector mode
LOG(WT)	True-S
LOG(WTC)	True-G
LOG(BT)	True-G
GPS(BT)	True-G
REF(BT)	True-G
MAN(WT)	True-S
MAN(WTC)	True-G

Relative vector

Relative vectors on targets that are not moving over the ground such as land, navigational marks and ships at anchor will represent the reciprocal of own ship's ground track. A target whose vector passes through own ship is on a collision course. (Dotted lines in the figure are for explanation only.)

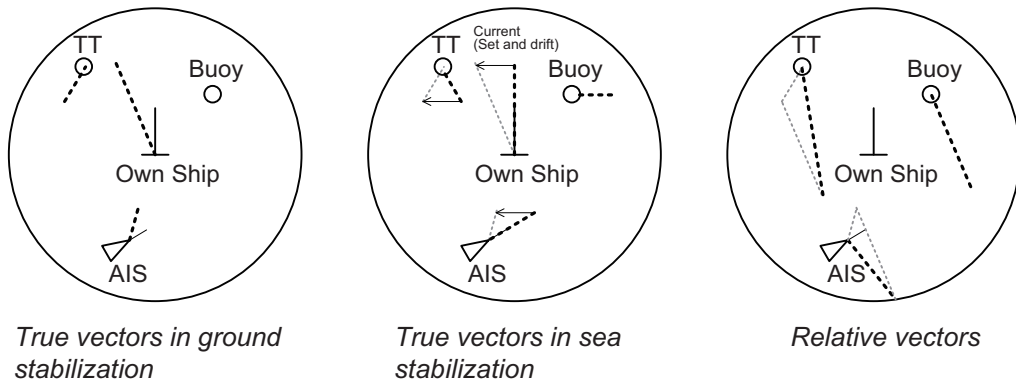

3.9.2 Vector motion and length

Vectors may be displayed in true or relative motion. Vector time (or the length of vectors) can be set between 30 seconds and 60 minutes.

The vector tip shows an estimated position of the target after the selected vector time elapses. It can be valuable to extend the vector length to evaluate the risk of collision with any target.

From the Control Unit

Vector motion: Push the **VECTOR MODE** key consecutively to select relative or true vector mode. Your selection is shown in the Vector mode indication.

Vector length: Push the **VECTOR TIME** key consecutively to select vector time, among 30 seconds, 1 minute, 3 minutes, 5 minutes, 6 minutes, 10 minutes, 20 minutes, 30 minutes, 45 minutes and 60 minutes.

By trackball module

Vector motion: Click the vector motion indication at the right side of the screen to select relative or true vector mode.

Vector length: Click the vector time indication at the right side of the screen to select time among 30 seconds, 1 minute, 3 minutes, 5 minutes, 6 minutes, 10 minutes, 20 minutes, 30 minutes, 45 minutes and 60 minutes. Or, spin the scrollwheel to select the length from 30 seconds or 1 - 60 minutes, in one-minute intervals.

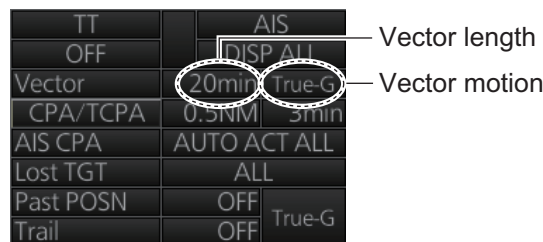

3.10 Past Position Display

The past position display shows equally time-spaced dots marking the past positions of any targets being tracked.

If a target changes its speed, the spacing will be uneven. If it changes the course, its plotted course will not be a straight line. See the illustration below for dot pattern and ship status.

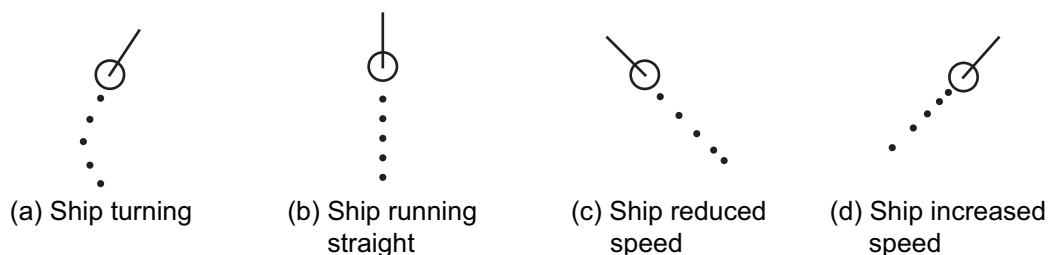

3. TARGET TRACKING (TT)

3.10.1 How to enable/disable the past position display, select past position reference

Click the indications circled in the figure below to set the plot interval (or disable the display) and the past position reference (true or relative).

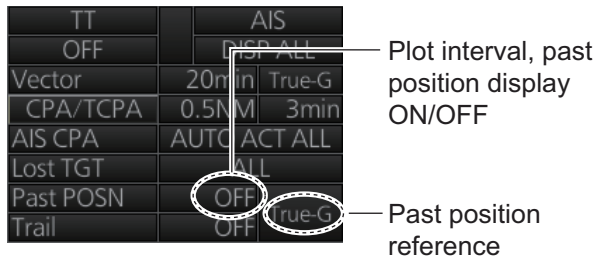

3.10.2 Past position points

You can show 5 or 10 past position points per tracked target. Right-click the past position indication then select [Past POSN Menu] to show that menu. Set [6 TT•AIS PAST POSN POINTS] to [5] or [10].

3.11 How to Enter Set and Drift

Set, the direction in which a water current flows, can be manually entered in 0.1-degree steps. Drift, the speed of the tide, can also be entered manually in 0.1 knot steps.

When course through water and speed through water are available, activate set and drift to get course over ground and speed over ground.

Set and drift corrections are beneficial for increasing the accuracy of vectors and target data. Refer to the tide table on board the ship for setting information. These values are applied to all targets. If stationary targets have vectors, set and drift values should be adjusted until they lose vectors.

Note: For the IMO type, turn off the AIS function in order to enter set and drift.

To enter set and drift do the following:

1. Right-click the Sensor information then select [OS Info Menu] to show the [OWN SHIP INFO] menu.
2. Select [2 SYSTEM SETTING] or [3 LOCAL SETTING] as appropriate.
3. Use the right and left arrow buttons to select the [SPD] page.
4. Set [Stabilization Mode] to [Water].
5. Click the [Set Drift] box to show a checkmark in the box.
6. Put the cursor in the course input box then spin the scrollwheel to select the set.
7. Put the cursor in the drift input box then spin the scrollwheel to select the drift.
8. Click [OK].
9. Close the menu.

Note: Set and drift should be checked periodically for correctness.

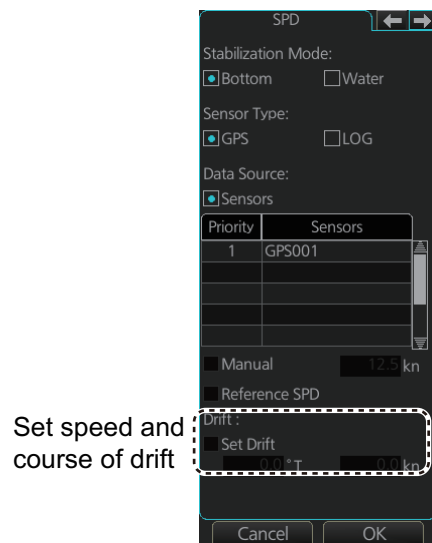

3.12 TT CPA/TCPA Alarm

The TT continuously monitors the predicted range at the Closest Point of Approach (CPA) and predicted time to CPA (TCPA) of each TT. When the predicted CPA of any TT becomes smaller than the preset CPA range and its predicted TCPA less than the preset TCPA limit, the audio alarm sounds and the Alert 526 (ALF format: 191,1) "TT CPA/TCPA" appears in the [Alert] box. In addition, the symbol of the offending TT is red and flashes together with its vector.

This feature, when used correctly, helps prevent the risk of collision by alerting you to threatening targets. It is important that the gain, sea clutter and rain clutter and other radar controls are properly adjusted.

The accuracy of TT calculations is a function of several variables including target glint, clutter conditions and signal-to-noise ratio. The design of the TT minimizes the effects of these variables but you must be aware that such errors will produce inaccuracies in the derived CPA and TCPA in particular during the initial tracking period.

CPA and TCPA settings must be set up properly taking into consideration the size, tonnage, speed, turning performance and other characteristics of own ship.

The TT CPA/TCPA alarm should not be solely relied upon to warn you of collision situations. The operator should check all aids to navigation to monitor possible collision situations.

3.12.1 How to set the CPA and TCPA limits

To set the CPA and TCPA ranges, do the following:

1. If the values for CPA and TCPA are blank, click [CPA/TCPA] to show them.
2. Click the CPA indication to select desired CPA range (0.1-20 NM).
3. Click the TCPA indication to select desired TCPA time (1-60 minutes).

TT	AIS	
OFF	DISP ALL	
Vector	20min	True-G
CPA/TCPA	0.5NM	3min
AIS CPA	AUTO ACT ALL	
Lost TGT	ALL	
Past POSN	OFF	True-G
Trail	OFF	

CPA setting TCPA setting

3.12.2 How to enable, disable the TT CPA/TCPA alarm

The TT CPA/TCPA alarm can be enabled or disabled from the TT/AIS box. Click the indication shown in the right figure to enable or disable the TT CPA/TCPA alarm. The alarm is disabled when the CPA and TCPA settings are not shown.

TT	AIS	
OFF	DISP ALL	
Vector	20min	True-G
CPA/TCPA	0.5NM	3min
AIS CPA	AUTO ACT ALL	
Lost TGT	ALL	
Past POSN	OFF	True-G
Trail	OFF	

3.12.3 How to acknowledge the TT CPA/TCPA alarm

When the CPA or TCPA of a target is within the CPA and TCPA limits, the Alert 526 (ALF format: 191,1) "TT CPA/TCPA" appears in the [Alert] box and the audio alarm sounds. To acknowledge the alarm and silence the buzzer, push the **ALARM ACK** key on the Control Unit, or click the alert indication in the [Alert] box.

3. TARGET TRACKING (TT)

The alert in the [Alert] box and the flashing of the plotting symbol and vector continue until the dangerous situation is gone or you intentionally terminate tracking of the target.

3.13 TT Lost Target Alert

Tracked targets not detected in nine consecutive scans become "lost targets". When this occurs;

- A red × is put on the TT symbol (flashing) of the lost target. (The lost target symbol disappears after the lost target alert is acknowledged.)
- The audio alert sounds and the Alert 527 (ALF format: 193,1) "TT Lost" appears in the [Alert] box.

3.13.1 How to enable, disable the TT lost target alert

The [Lost TGT] indication at the bottom-right position enables, disables the lost target alert. Click the indication to select [OFF], [FILT] or [ALL] as appropriate.

[OFF]: Disable the alert.

[FILT]: Get the alert against the targets whose criteria meet the settings made in section 3.13.2.

[ALL]: Get the alert against all lost targets.

TT	AIS	
OFF	DISP ALL	
Vector	20min	True-G
CPA/TCPA	0.5NM	3min
AIS CPA	AUTO ACT ALL	
Lost TGT	ALL	
Past POSN	OFF	True-G
Trail	OFF	True-G

Note: The [Lost TGT] setting is shared commonly between TT and AIS.

3.13.2 How to set the TT lost target filter

If you are in an area where tracked targets are lost frequently, you may want to disable the lost target alert against certain tracked targets, by maximum range.

1. Right-click the TT mode indication then select [TT Menu] to show that menu.
2. Select [3 LOST FILTER MAX RNG].
3. Select [ON]. Select the range setting then spin the scrollwheel to set the range. Any TT lost targets beyond this range will not trigger the TT lost target alert.
4. Close the menu.

Appears for B-types only

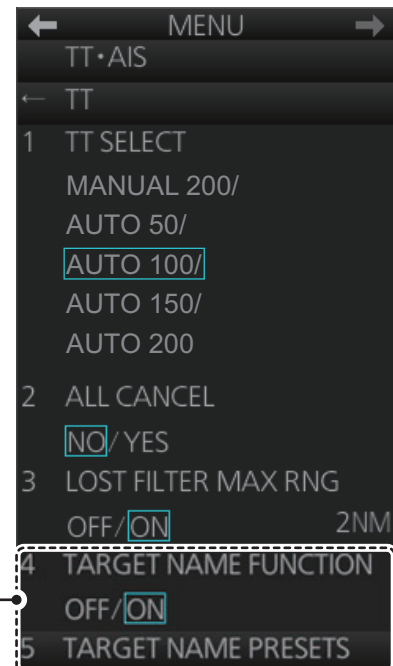

3.14 Trial Maneuver

The trial maneuver feature simulates the effect of own ship's movement against all tracked targets, without interrupting the updating of target information. It is available for use with the TT and AIS functions. For more accurate results, use relative motion and sea stabilization (water tracking).

3.14.1 Types of trial maneuvers

There are two types of trial maneuvers: dynamic and static.

Dynamic trial maneuver

A dynamic trial maneuver displays predicted positions of the tracked targets and own ship. You enter own ship's intended speed and course with a certain "delay time." Assuming that all tracked targets maintain their present speeds and courses, the targets' and own ship's future movements are simulated in 0.5-second increments indicating their predicted positions in 30-second intervals as illustrated in the right figure.

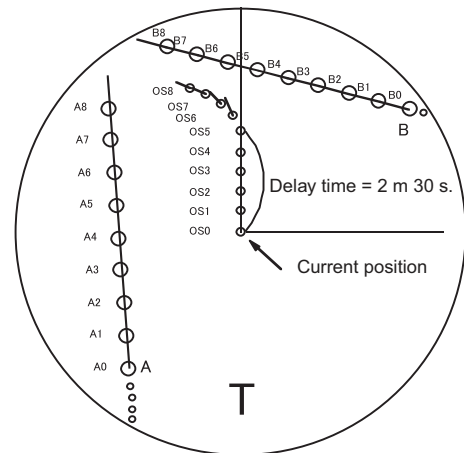

The delay time represents the time lag from the present time to the time when own ship will actually start to change her speed and/or course. You should therefore take into consideration own ship's maneuvering characteristics such as rudder delay, turning delay and acceleration delay. This is particularly important on large vessels. Regardless of how much delay is set the situation starts immediately and ends in a minute.

In the example shown on the previous page, own ship will advance straight ahead (even after a maneuver) for a delay time of 2:30 and alters speed and course until operator-specified intended speed and course are achieved (position OS7 in this example).

Static trial maneuver

The static trial maneuver shows the relationship between your ship and tracked targets at the completion of the trial maneuver. The expected position of TTs at the end of the trial maneuver are shown on the display.

By shortening and extending the trial time you can find the safe time to make a maneuver. Thus, the static trial maneuver will be convenient when you wish to know the maneuver result immediately.

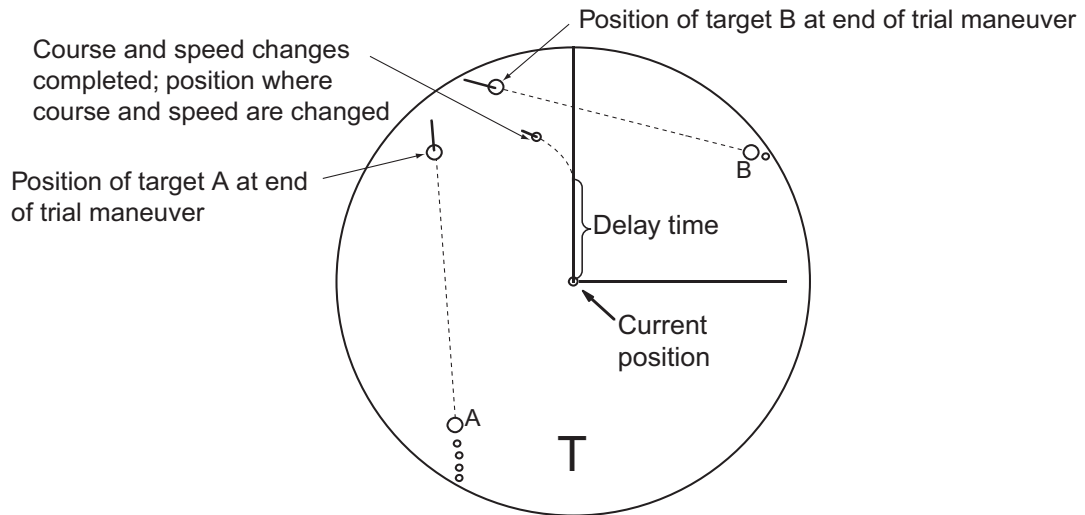

3.14.2 How to do a trial maneuver

To do a trial maneuver:

1. Right click the DELAY setting in the [Trial] box (see step 7) then select [Trial Maneuver Menu].
2. Select [1 TRIAL MANEUVER] then select [STATIC] or [DYNAMIC] as appropriate.
3. Select [2 SPEED RATE] then set the speed rate with the scrollwheel. For low speed, enter the ship's speed and the speed rate on the upper line, then push the left button. For high speed, enter the ship's speed and the speed rate on the lower line, then push the left button.
4. Select [3 TURN RATE] then set the turn rate with the scrollwheel. For low speed, enter the ship's speed and the turn rate on the upper line, then push the left button. For high speed, enter the ship's speed and the turn rate on the lower line, then push the left button.

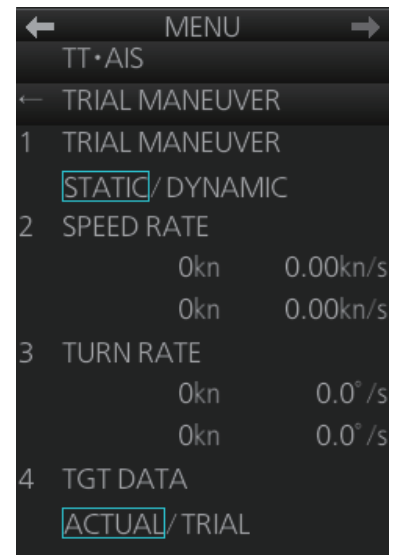

Note 1: Two sets of trial speed and trial turn rate combinations are provided. This is done to provide accurate trial maneuver results for various ship's speeds and turn rates.

Note 2: If the speed rate or turn rate are not entered and left as blank ([0.00kn/s] or [0.0°/s]), the trial immediately begins at the set speed and course.

3. TARGET TRACKING (TT)

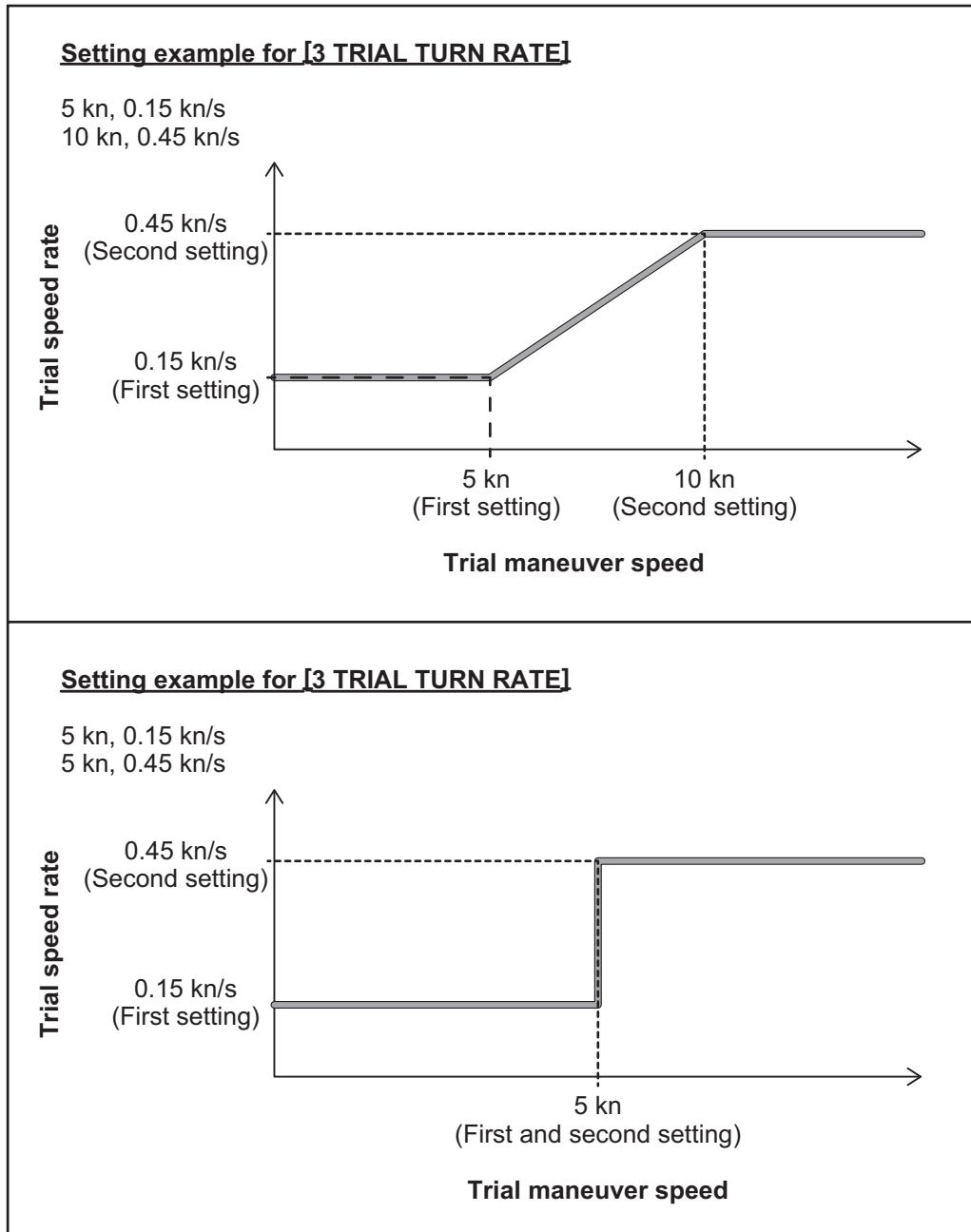

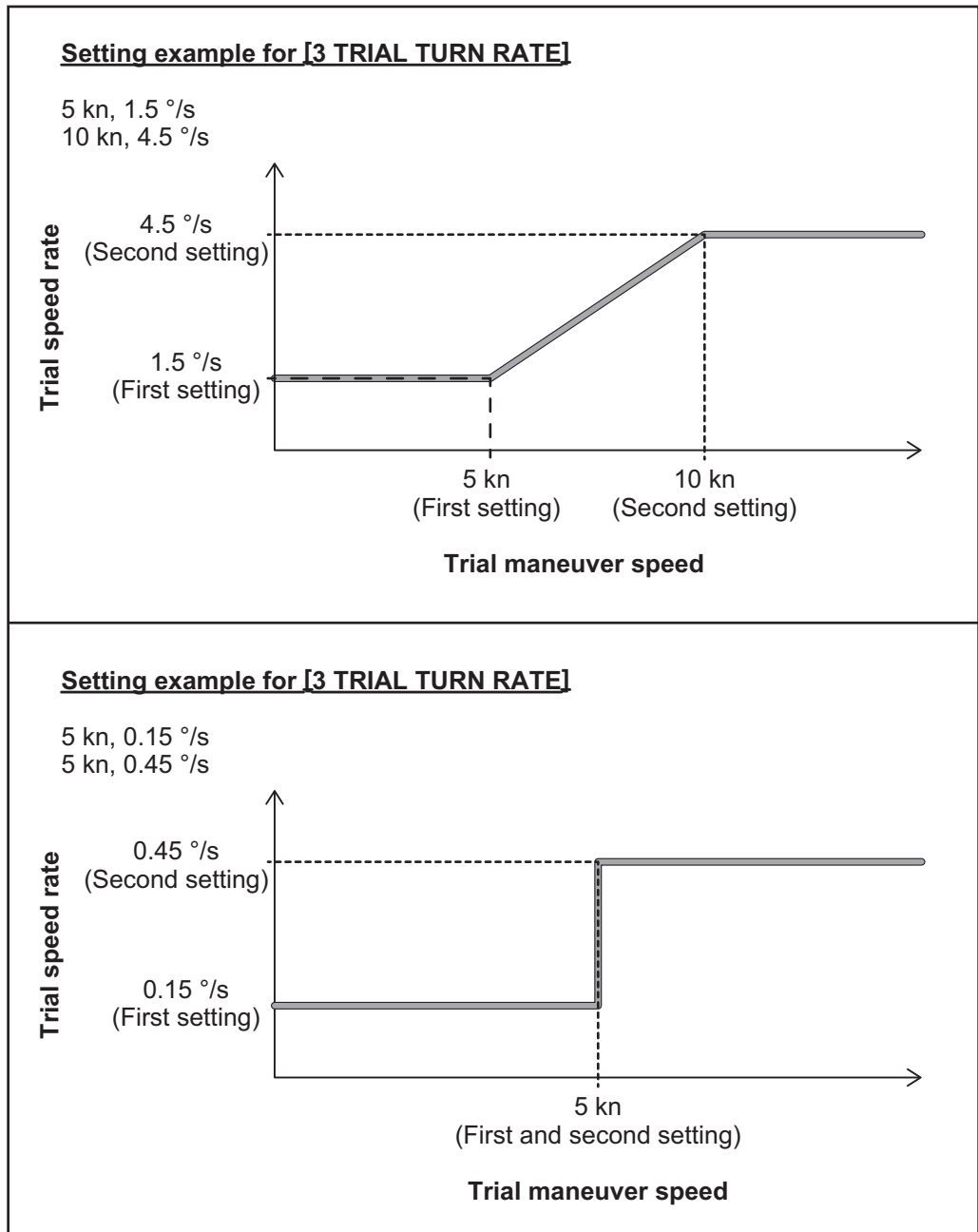

5. **For B-type radars**, select [4 TGT DATA] then select whether to use [ACTUAL] or [TRIAL] data. (Skip this step if your radar is the IMO or A type.)
6. Close the menu.
7. Find the [Trial] box at the right side of the screen.

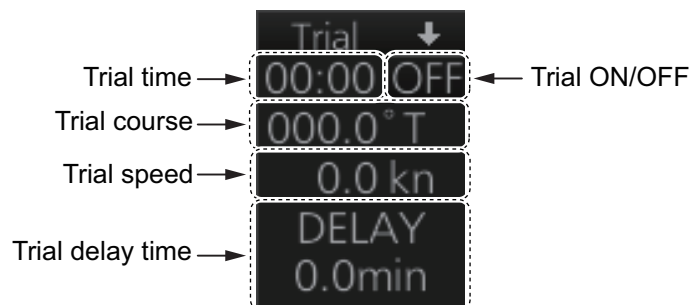

8. Right-click the Trial title bar, select [Trial Mode] then select a trial mode, [Static] or [Dynamic].

3. TARGET TRACKING (TT)

9. Click the Trial ON/OFF indication to show [ON].
10. Put the cursor on the Trial course indication. Spin the scrollwheel to set the trial course.
11. Put the cursor on the Trial speed indication. spin the scrollwheel or use the Control Unit to set the trial speed.
12. Put the cursor on the [DELAY] indication. Spin the scrollwheel to set the amount of delay. This is the time after which own ship takes a new situation, not the time the simulation begins. Change the delay time according to own ship loading condition, etc.

The time indication depends on trial mode:

Dynamic mode: The position of your ship and TTs is displayed every 30 seconds and updating occurs every 0.5 seconds.

Static mode: The position of your ship and TTs when set course and speed are reached are displayed. Put the cursor in the Trial time indication and roll the scrollwheel. Increase or decrease the time to get a safe maneuver. If a maneuver is unsafe, change speed, course and delay until it is safe.

The trial maneuver takes place with the letter "T" displayed at the bottom of the screen. The time appears at the top-right position on the display. If any TT is predicted to be on a collision course with own ship (that is, the target ship comes within preset CPA/ TCPA limits), the target plotting symbol flashes. If this happens, change own ship's trial speed, course or delay time to obtain a safe maneuver.

3.14.3 How to terminate a trial maneuver

The termination method depends on the trial mode as follows:

Dynamic mode: The trial is terminated when 60 minutes is shown in the Trial time indication.

Static mode: The trial is terminated when you terminate the trial maneuver manually.

To terminate the trial maneuver manually, click the Trial ON/OFF indication to show [OFF].

3.15 TT Simulation Mode

You can simulate the risk of collision by using the TT simulation mode and the trial maneuver together.

1. Execute the TT simulation mode as follows:
 - 1) Open the menu then select [8 INITIAL SETTING] and [8 TT SIMULATION MODE].
 - 2) The confirmation message "Attention: Do you wish to start TT SIMULATION MODE?" appears. Click the [OK] button to start the test.
2. The normal operation is suspended then three simulated targets appear on the display.

The indication "S" appears at the bottom of the effective display area during the simulation mode. The simulation may be terminated any time by going to the STBY mode.

Three simulated targets move as the following table. The simulated target is automatically generated with the relative movement in the following table based on own ship's movement at the start of simulation mode.

Note: If own ship moves after the start of simulation mode, the movement of the simulated target is not matched with the values in the following table.

	Range (R)	Bearing (R)	Speed (R)	Course (R)	CPA	TCPA
Target A	9.5 NM	270.0°	20.0 kn	90.0°	0.0 NM	28.5 min
Target B	1.1 NM	333.0°	10.2 kn	90.2°	1.0 NM	2.9 min
Target C	9.3 NM	45.0°	19.9 kn	225.1°	0.0 NM	28.0 min

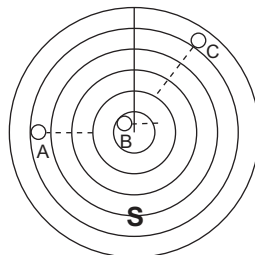

3. Acquire the simulated targets after the TT simulation mode is performed. The tracking state changes from unstable to stable and the vector appears. You can simulate the movement of each function with changing true/relative vector, stabilization through the water/over the ground, range or length of vector.
4. After the target B crosses in front of own ship, that is the target B is not a dangerous target, you can simulate the risk of collision by using the trial maneuver as follows:
 - 1) Set the TT CPA/TCPA alarm. For example, set 0.5 nm for CPA, 30 min for TCPA.
 - 2) Execute the trial maneuver (see section 3.14). In the static mode, the movements of own ship and the target after the time set as the trial time elapses are displayed. If the target is dangerous after the time set as the trial time elapses, its symbol is the one for the dangerous target. Adjust the trial course and trial delay time so the target symbol does not become the dangerous symbol when executing the trial maneuver.

3.16 TT Alerts

The table below list situations that cause the TT to trigger visual and audio alerts. To acknowledge the audio alerts, push the **ALARM ACK** key, or click the [Alert] box.

Alert No.	Message	Category	Description
ALR: 521 ALF: 192,1	TT New Target	Warning	Tracked target entered the acquisition zone.
ALR: 522 ALF: 10190,4	TT Auto ACQ 95%	Caution	The capacity for auto acquisition has reached 95%.
ALR: 523 ALF: 190,4	TT Auto ACQ 100%	Warning	The capacity for auto acquisition has reached 100% and no more target acquisition is possible. Cancel tracking on unnecessary targets.
ALR: 524 ALF: 10190,5	TT Man ACQ 95%	Caution	The capacity for manual acquisition has reached 95%.
ALR: 525 ALF: 190,5	TT Man ACQ 100%	Warning	The capacity for manual acquisition has reached 100% and no more target acquisition is possible. Cancel tracking on unnecessary targets.
ALR: 526 ALF: 191,1	TT CPA/TCPA	Alarm	Tracked target on collision course. Take evasive action.
ALR: 527 ALF: 193,1	TT Lost	Warning	Tracked target lost. Check target.
ALR: 528 ALF: 193,2	REF Target Lost	Warning	Tracked target used for speed input is lost. To continue using reference target for speed input, select another tracked target.

3.17 How to Set a Target Name (B-types only)

You can assign a preset name to TT targets, which is displayed alongside the TT symbol on-screen, beside the target number in the target list and in the pop-up target data.

3.17.1 How to enable the target name feature

1. Right-click the TT mode indication then select [TT Menu] to show that menu.
2. Select [4 TARGET NAME FUNCTION].
3. Select [ON].
4. Close the menu.

3.17.2 How to set up preset names

1. Right-click the TT mode indication then select [TT Menu] to show that menu.
2. Select [5 TARGET NAME PRESETS].

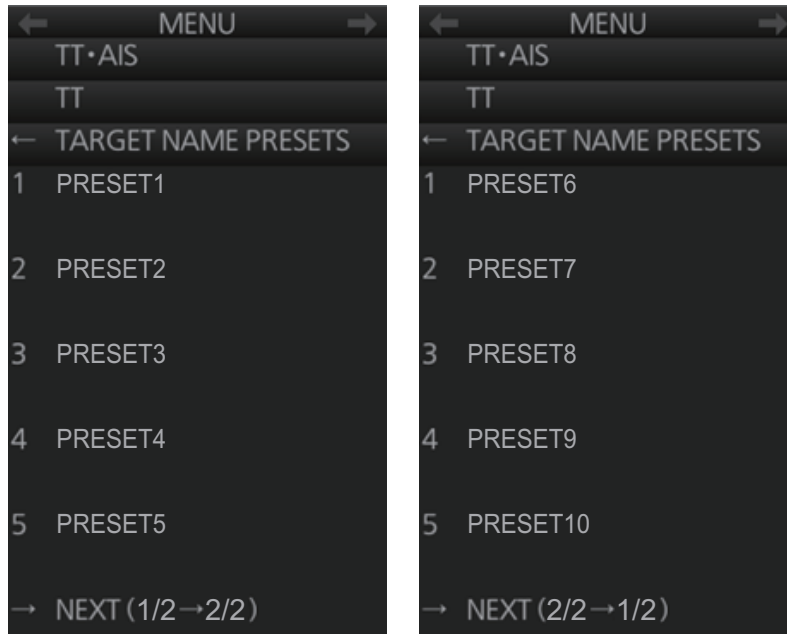

Page 1

Page 2

3. Select the preset number you want set up. The software keyboard appears.

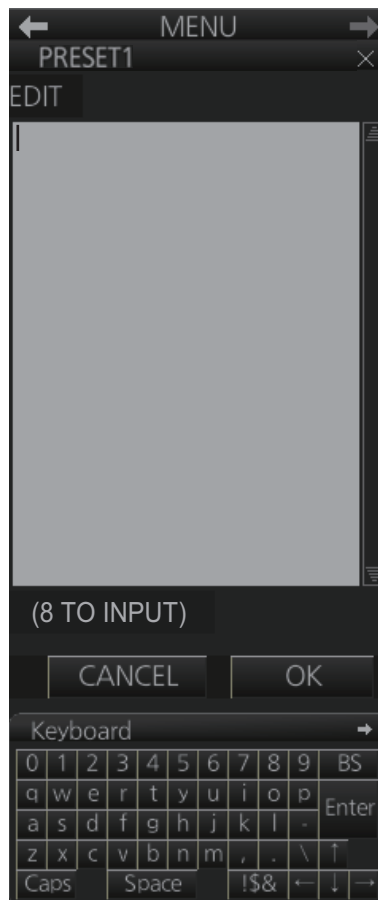

4. Input a name for the preset (maximum eight characters), then click [OK].
5. Close the menu.

3. TARGET TRACKING (TT)

3.17.3 How to assign a name to a target

1. Referring to section 3.17.1, enable the target name feature.
2. Referring to section 3.8.1, display the data for the target you want to name.
3. Right-click the target information, then select [Edit Target Name]. The editing window appears.

Note: When [4 TARGET NAME FUNCTION] is set to [OFF], [Edit Target Name] is not selectable.

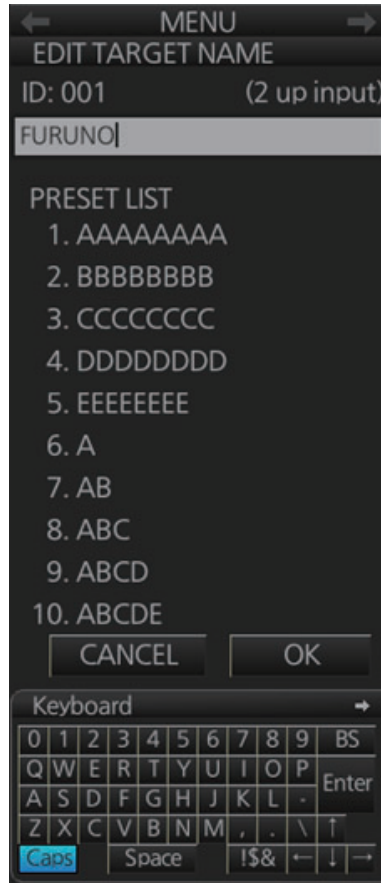

4. Do one of the following to assign a name to the target:
 - Select a preset from the [PRESET LIST]. The selected name appears in the input section at the top of the window.
 - Enter a name using the software keyboard.
5. Select OK to confirm the name.
The assigned name now appears in the target list, target information window and beside the TT symbol on the screen (see figure to the right).



3.18 Criteria for Selecting Targets for Tracking

The FURUNO TT video processor detects targets in midst of noise and discriminates radar echoes on the basis of their size. Target whose echo measurements are greater than those of the largest ship in range or tangential extent are usually land and are displayed only as normal radar video. All smaller ship-sized echoes that are less than this dimension are further analyzed and regarded as ships and displayed as small circles superimposed over the video echo.

When a target is first displayed, it is shown as having zero true speed but develops a course vector as more information is collected. In accordance with the IMO requirements for TT, an indication of the motion trend should be available within 20 scans of antenna and full vector accuracy within 60 scans. The FURUNO TT complies with these requirements.

Echo detection (quantization)

The entire picture is converted to a digital form called "Quantized Video". A sweep range is divided into small segments and each range element is "1" if there is radar echo return above a threshold level, or "0" if there is no return.

The digital radar signal is then analyzed by a ship-sized echo discriminator. As the antenna scans, if there are five consecutive radar pulses with 1's indicating an echo presence at the exact same range, a target "start" is initiated. Since receiver noise is random, it is not three-bang correlated, and it is filtered out and not classified as an echo.

The same is true of radar interference. Electronic circuits track both the closest and most distant edges of the echo. At the end of the scanning of the echo, the discriminator indicates the measured maximum range extent and total angular extent subtended by the echo. If the echo is larger than a ship-sized echo in range extent and/or angular width, adjusted as a function of range, it is declared to be a land. This land echo is not used by TT acquisition and tracking process. All smaller echoes are declared to be ship sized and the middle of the leading edge is used to provide precise range and bearing coordinates of each echo on every scan. This range/bearing data is matched to previous data and analyzed from scan-to-scan for consistency. When it is determined to be as consistent as a real target, automatic acquisition occurs and tracking is initiated. Continued tracking and subsequent calculation develop the relative course and speed of the target.

Acquisition

A target that is hit by five consecutive radar pulses is judged to be a radar echo. Manual acquisition is done by designating a detected echo with the trackball. Automatic acquisition is done in the acquisition areas when a target is detected 5-7 times continuously depending upon the congestion.

Tracking

The range and bearing of an echo are found from the relative distance of the target from the radar antenna. The distance a tracked target moves between radar antenna rotations is used to calculate the relative speed of the tracked target. However, because of calculation error, smoothing is applied to get stable target speed and course data. When a target changes course, smoothing is reduced in order to quickly follow target movement.

3. TARGET TRACKING (TT)

Tracking is achieved when the target is clearly distinguishable on the display for 5 out of 10 consecutive scans, whether acquired automatically or manually.

Required tracking facilities are available within 0.1-32 nm on range scales including 3, 6, 12 nm, full plotting information is available within one scan when the range scale is changed. Targets not detected in nine consecutive scans become "lost targets".

The true course and speed of own ship are computed from own ship's gyro and speed inputs, and the resulting course and speed of each tracked target is easily computed by vector summing of the relative motion with own ship's course and speed. The resulting true or relative vector is displayed for each of the TTs. This process is updated continually for each target on every scan of the radar.

The REF point for tracked target calculation can be the radar antenna position or the CCRP. For CCRP, the displayed value includes the distance between the CCRP and the antenna position. Therefore, when switching the REF point, the range, bearing, CPA and TCPA of the tracked targets change.

Qualitative description of tracking error

The FURUNO TT's accuracy complies with or exceeds IMO standards.

Own ship maneuvers

For slow turns there is no effect. For very high turning rates (greater than 150°/minute, depending on gyro), then all tracked targets revert to full accuracy.

Other ship maneuvers

Target ship courses; lag 15 to 30 seconds at high relative speed, or 3 to 6 seconds at low (near 0) relative speed. It is less accurate during a turn due to lag, but accuracy recovers quickly.

3.19 Factors Affecting Target Tracking

Sea returns

If the radar anti-clutter control is adjusted properly, there is no serious effect because distant wave clutter, not eliminated by this control, is filtered out by more than one bang correlation and scan-to-scan matching of data.

Rain and snow

Rain clutter can be acquired and tracked as targets. Adjust the rain clutter control to suppress the clutter. If it is heavy rain, switch to S-band if provided, or switch on the interference rejector on the radar. If heavy clutter still exists, switch to manual acquisition. Accuracy can be affected.

Low clouds

Usually no affect. If necessary, adjust the rain clutter control.

Non-synchronous emissions

No effect.

Low gain

Insufficient or low radar receiver gain will result in some targets not being acquired at long distance. The TT display will be missing on one or more targets that could only be visible if the radar sensitivity control (**GAIN** control) were increased.

The setting of the correct radar receiver gain is not critical but the target should be on the radar PPI and be clearly visible and well defined.

Manual acquisition is done if a target is positively displayed more than once. Automatic acquisition is done when the target is detected 5-7 times continuously.

Tracking continues if a return echo is received at least once in nine antenna rotations. However, the fewer the return echoes the lower the accuracy. If no return echo is received within nine antenna rotations the target is declared a lost target.

Second trace echoes

When the radar beam is super refracted, strong echoes may be received at such long ranges that they appear on a different timebase sweep than the transmitted pulse. This gives an incorrect range indication. Second- and third-trace echoes can be tracked if they are consistent enough to meet acquisition and tracking criteria but target course and speed data will be in error.

Blind and shadow sectors

Radar shadow or blind areas caused by obstructions aboard the ship, for example, funnels and masts, in the path of the radar beam can result in reduction of radar beam intensity in that particular direction. This may eliminate the detection of some targets. The TT system will lose track of targets shortly after they are lost on the radar picture and if they remain in a blind zone. These targets will however be acquired and tracked when they pass out of the blind zone and again present normal radar echo. The angular width and bearing of any shadow sector should be determined for their influence on the radar. In certain cases false echoes in the shadow sector cause the TT system to acquire, track, and vector them. Shadow sectors should be avoided.

Indirect echoes

A target at close range is usually picked up directly, but it can also be received as reflection from a large, flat surface. This will result in the radar presenting two or more echoes on the display, each at a different range. The TT system can acquire and track a false echo if it is detected in five consecutive scans. Reduction in radar gain can eliminate the multiple echoing but care should be taken as range detection also will be reduced.

Radar interference

If interference is extreme due to another radar operating at close range, spiral "dotting" and/or false targets may appear momentarily. The interference rejector can clear the display.

Delay of sensor input

If the refresh rate of the gyrocompass signal is too slow, error in target bearing occurs when own ship turns. To prevent this error, the refresh rate of the gyrocompass signal must be as indicated in the System Configuration drawings.

3. TARGET TRACKING (TT)

This page is intentionally left blank.

4. AIS OPERATION

An AIS transponder can be connected to this radar to overlay AIS targets on the radar display. The radar can store up to 2,000 AIS targets in its storage buffer. When this buffer becomes full of AIS targets, the Alert 533 (ALF format: 190,2) "AIS Target Capacity 100%" is generated to alert you to full storage buffer. The storage buffer contains automatic dead reckoning for all AIS targets, which is based on reported Speed Over the Ground (SOG), Course Over the Ground (COG), Rate Of Turn (ROT) and heading. The storage buffer also contains calculation of range, bearing, CPA, TCPA, etc. The CPA and TCPA limits set for dangerous targets are common for TT and AIS targets.

This radar can activate 500 AIS targets. The Alert 535 (ALF format: 190,1) "AIS Target Activate 100%" is generated when 500 AIS targets are activated.

This radar can display a maximum of 1,000 AIS targets. The Alert 531 (ALF format: 190,3) "AIS Target Display 100%" is generated when 1,000 AIS targets, which includes both activated and sleeping targets, are displayed.

The frequency for update of AIS transponder-sent data depends on speed and course of tracked AIS target. The table below shows the IMO standardized reporting rates for the AIS transponder. Based on the table below, the radar defines which AIS targets are in tracking or lost. When you acknowledge a lost target alert, the corresponding AIS symbol will be removed from the display.

Type of Ship	IMO nominal reporting interval	Lost target indication (reporting interval >)
Class A: Navigation status is "anchor" or "not under command" or "moored" or "aground", and SOG \leq 3kn	3 min	10 min
Class A: Navigation status is "anchor" or "not under command" or "moored" or "aground", and SOG > 3kn	10 s	50 s
Class A: 0kn \leq SOG < 14kn	10 s	50 s
Class A: 14kn \leq SOG \leq 23kn	6 s	30 s
Class A: SOG > 23kn	2 s	10 s
Class B: "CS" SOG < 2kn	3 min	10 min
Class B: "CS" SOG \geq 2kn	30 s	150 s
Class B: "SO" 0 kn \leq SOG < 2kn	3 min	10 min
Class B: "SO" 2 kn \leq SOG < 14kn	30 s	150 s
Class B: "SO" 14 kn \leq SOG \leq 23kn	15 s	75 s
Class B: "SO" SOG > 23kn	5 s	25 s
Class A and Class B: no SOG available	N/A	10 min
AIS SAR aircraft	10 s	50 s
AIS aid to navigation	3 min	10 min
AIS base station	10 s	50 s
AIS search and rescue transponder	N/A	10 min

Note: AIS operations on IMO-types require the WGS-84 Datum. Make sure the GPS connected to the radar is set to WGS-84.

4. AIS OPERATION

An AIS transponder "sees" all ships fitted with an AIS transponder belonging to either a Class A or Class B AIS. Additionally, the AIS transponder receives messages from ships and non-ships (AIS SAR aircraft, AIS aid to navigation, AIS base station, and AIS search and rescue transmitter).

There can be several hundreds or several thousands of AIS targets, and of those only a few will be significant for your ship. To remove unnecessary AIS targets from the radar display, the feature "active and sleeping AIS targets" is available. Initially any new AIS target received by an AIS transponder is not active (= "sleeping"). Such sleeping targets are shown with a small triangle. The operator can pick any AIS target and change it from sleeping to active. Active AIS targets are shown with a large triangle with speed vector, headline, ROT indicator, etc. Further, the operator can pick active AIS targets and change their status to sleeping.

An indication of AIS target activated capacity limit is given well before it is reached. When 95% of 500 targets are activated, the Alert 534 (ALF format: 10190,3) "AIS Target Activate 95%" appears. When 500 targets are activated, the Alert 535 (ALF format: 190,3) "AIS Target Activate 100%" appears.

An indication of AIS target display capacity limit is given well before it is reached. When 95% of 1,000 targets are displayed, the Alert 530 (ALF format: 10190,1) "AIS Target Display 95%" appears. When 1,000 targets are displayed, the Alert 531 (ALF format: 190,3) "AIS Target Display 100%" appears.

An indication of AIS target processing capacity limit is given well before it is reached. The Alert 533 (ALF format: 190,2) "AIS Target Capacity 100%" appears when 2,000 targets are in the storage buffer.

This radar generates AIS-related alerts. These are Alert 536 (ALF format: 191,2) "AIS CPA/TCPA" and Alert 537 (ALF format: 193,3) "AIS Lost". Only active AIS targets generate alerts. The operator can activate or sleep AIS target alerts as desired. The feature "active and sleeping AIS targets" is very effective for focusing on only those AIS targets that need supervision. This radar further eases the task of the operator by automatically changing non-active targets to active targets, if their CPA and TCPA are within a preset limit.

4.1 How to Deactivate the AIS Function

Long-click the AIS mode indication at the bottom-right position to display [FUNC OFF] to deactivate the AIS function (sleep all AIS targets) and AIS messaging facility. To activate AIS, push the left button again.

TT	AIS	
OFF	DISP ALL	
Vector	20min	True-G
CPA/TCPA	0.5NM	3min
AIS CPA	AUTO ACT ALL	
Lost TGT	ALL	
Past POSN	OFF	True-G
Trail	OFF	

Note: You cannot enable AIS if any of the items listed below are active.

- Manual speed
- Speed is calculated from reference targets
- Manual set & drift

4.2 How to Show, Hide the AIS Display

Targets that are being tracked by an AIS transponder can also be displayed on the display. Click the AIS mode indication to select [DISP OFF], [DISP FILT] or [DISP ALL].

TT	AIS	
OFF	DISP ALL	
Vector	20min	True-G
CPA/TCPA	0.5NM	3min
AIS CPA	AUTO ACT ALL	
Lost TGT	ALL	
Past POSN	OFF	True-G
Trail	OFF	True-G

[DISP OFF]: Turn off the AIS display. (Tracking continues internally.)









[DISP FILT]: Filter AIS targets according to the settings of the AIS target filter. See section 4.4.

[DISP ALL]: Display all AIS targets.











4.3 AIS Symbols

Target symbols

AIS targets are marked with an appropriate symbol as shown in the table below.

Symbol	Default color	Name	Description
	Green	AIS tracked target past position point	Mark past position.
	Green	Sleeping AIS target	Denote sleeping AIS symbol. (Lines are thinner than Active AIS symbol.)
	Green	Activated AIS target	Denote active AIS target, with vector for course and speed. (Lines are thicker than sleeping AIS symbol.) Color can be changed with the menu.
	Red (fixed)	Activated target in AZ (without acknowledgment)	Unacknowledged active AIS target in acquisition zone, with vector for course and speed. (Lines are thicker than sleeping AIS symbol.)
	Green	Activated target in AZ (with acknowledgment)	Acknowledged active AIS target in acquisition zone, with vector for course and speed. (Lines are thicker than sleeping AIS symbol.) Color can be changed with the menu.
	Green	Activated target, true scale symbol	Active AIS target with symbol shown in true scale. Association AIS symbol or activate AIS symbol is displayed within the ship's symbol when activated. This symbol disappears when the size of the true scale symbol is smaller than 3 mm on the display.
	Blue	AIS SART test	Denote AIS SART (search and rescue radar transponder) test.
	Red (fixed)	Dangerous AIS target	Target's CPA and TCPA are within the CPA and TCPA settings. Vector shown. The symbol flashes until acknowledgment.

4. AIS OPERATION

Symbol	Default color	Name	Description
	Green	Association AIS target	AIS and TT target declared as "association target". AIS symbol and AIS data are used.
	Red (fixed)	Association AIS dangerous target	AIS and TT target declared as "association target". AIS symbol and AIS data are used. Target's CPA and TCPA are within limits set.
	Green	Heading-turn indicator	Show target's direction of turning.
	Green	SAR Aircraft	Denote SAR aircraft.
	Blue	AIS base station	Denote AIS base station.
	Green	AIS select symbol	Target selected to display its data.
	Green	SAR vessel	SAR (search and rescue) vessel
	Red (fixed)	AIS lost symbol	X is superimposed on the AIS target symbol and is flashing.
	Green	Non HDG/COG sleeping AIS target	Denote sleeping AIS symbol without HDG and COG. Dashed line.
	Green	Non HDG/COG activated AIS target	Denote active AIS symbol without HDG and COG. Dashed line.

Note 1: The equipment continues to process AIS targets when the AIS feature is switched off. When the AIS is again turned on, symbols are immediately displayed.

Note 2: AIS symbols are momentarily erased after the screen is redrawn when the heading is changed from the head-up mode.

Note 3: When no AIS data is received, the Alert 380 (ALF format: 10380,131) "AIS COM Error" appears in the [Alert] box. Check the AIS transponder.

Note 4: An AIS target is declared a lost target if it is not detected in five consecutive reporting periods (see the table on page 4-1).

Note 5: Physical and virtual AIS AtoN symbols that may appear are listed in the table on the following page.

AIS physical and virtual AtoN symbols

The table below shows all the physical and AIS virtual AtoN symbols.

AIS Physical AtoN Symbol ¹	AIS Virtual AtoN Symbol	Default Color	Meaning
		Blue	Basic shape
		Blue	RACON
		Blue	Emergency wreck mark
		Blue	North cardinal mark
		Blue	East cardinal mark
		Blue	South cardinal mark
		Blue	West cardinal mark
		Blue	Port hand mark
		Blue	Starboard hand mark
		Blue	Isolated danger
			Safe water
		Blue	Special mark
OFF POSN 	—	Line: Yellow ² Char: Yellow ²	Off position (Displayed with yellow line and yellow text)
UNLIT 	UNLIT 	Line: Blue Char: Yellow ²	Light fail or at reduced range (Displayed with yellow text)
RACON ERR 	RACON ERR 	Line: Blue Char: Yellow ²	RACON error (Displayed with yellow text)
—	MISSING 	Line: Yellow ² Char: Yellow ²	Missing (Displayed with yellow dashed line and yellow text)

¹ The purpose indicator (for example, ●) appears at the top of a physical AtoN symbol. The indicator is always displayed in the radar mode, and when a symbol of this type is selected in the chart mode or chart radar mode. See the example below.

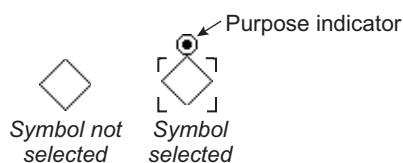

² Color not changeable.

4.4 How to Filter AIS Targets

If the screen becomes cluttered with AIS targets, you can filter out unnecessary AIS targets, from the [DISP FILTER] menu.

1. Right-click the AIS mode indication then click [AIS Menu] to show that menu.
2. Open the [5 DISP FILTER] menu.
3. At [1 SLEEPING CLASS A] - [5 VIRTUAL ATON], disable or enable tracking of respective item as appropriate.
4. Select [6 MAX RANGE] and set the maximum range to display an AIS target. A sleeping AIS target not within the range set here is not displayed.
5. Set the minimum ship speed for AIS targets, with [7 MIN SHIP SPEED]. Any sleeping AIS target whose speed is slower than that set here will not be displayed.
6. Close the menu.

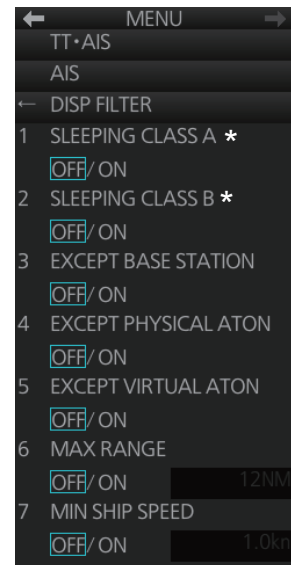

Note: This function is not available for an activated target.

* Not shown on IMO- or A-type specification.

4.5 How to Activate Targets

When you convert a sleeping target to an activated target, an activated target's course and speed are shown with a vector. You can easily judge target movement by monitoring the vector.

4.5.1 How to activate specific target

From the Control Unit

Select the target with the cursor then press the **ACQ/ACT** key.

By the trackball module

Click the AIS target symbol.

SOG (Speed Over the Ground) and COG (Course Over the Ground) vector^{*1}

^{*1} Vector shows STW (speed through the water) and CTW (course through the water) when sea stabilized mode is selected at the radar.

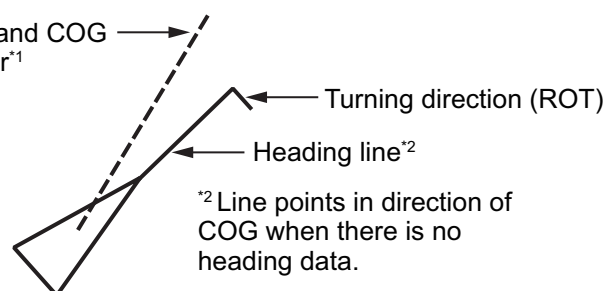

4.5.2 How to automatically activate targets

You can get automatic activation of a sleeping AIS target when its CPA/TCPA are within a preset limit. The CPA/TCPA alarm must be active to use this feature.

How to set conditions for automatic activation of AIS targets

1. Right-click the AIS mode indication then click [AIS Menu] to show that menu.
2. Open the [4 CPA AUTO ACTIVATE] menu.
3. Set each menu item, referring to the description below.
 - [1 MAX RANGE]: Set the maximum range to use. Any AIS target at a distance greater than set here will not be activated.
 - [2 MIN SHIP SPEED]: Set the minimum speed to use. Any AIS target whose speed is slower than set here will not be activated.
 - [3 EXCEPT CLASS B]: Select [ON] to exclude class B AIS targets.
4. Close the menu.

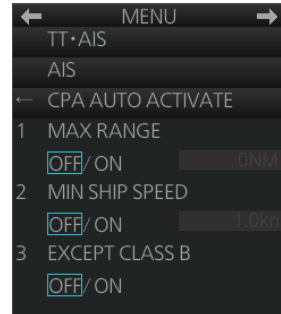

How to enable, disable automatic activation of AIS targets

Click the location circled in the figure below to select one of the following:

[AUTO OFF]: Disable automatic activation of AIS target by CPA.

[AUTO ACT FILT]: Activate AIS targets that fulfill the requirements set on the [CPA AUTO ACTIVATE] menu.

[AUTO ACT ALL]: Activate all AIS targets within the CPA range set.

TT	AIS	
OFF	DISP ALL	
Vector	20min	True-G
CPA/TCPA	0.5NM	3min
AIS CPA	AUTO ACT ALL	
Lost TGT	ALL	
Past POSN	OFF	True-G
Trail	OFF	

4.6 How to Sleep Targets

4.6.1 How to sleep an activated AIS target

You can "sleep" an activated AIS target as shown below when the screen becomes filled with targets that might prevent important radar and AIS targets from being identified. The targets that have been activated automatically cannot be "slept."

From the Control Unit

Put the cursor on the AIS target to sleep then press the **TARGET CANCEL** key.

By the trackball module

1. Right-click the screen to show the context-sensitive menu.
2. Select [Target Cancel] and [Any] or [AIS Only] as applicable.
3. Click the AIS target to sleep.

4.6.2 How to sleep all activated AIS targets

Sleep all activated targets from the menu

1. Open the menu then select [2 TT•AIS] and [4 AIS].
2. Select [3 SLEEP ALL TGTS] then [YES].
3. Close the menu.

Sleep all activated targets from the AIS box

Long-click the AIS mode indication at the bottom-right position to display [FUNC OFF] then click [DISP ALL] to sleep all AIS targets redisplayed.

TT	AIS	
OFF	DISP ALL	
Vector	20min	True-G
CPA/TCPA	0.5NM	3min
AIS CPA	AUTO ACT ALL	
Lost TGT	ALL	
Past POSN	OFF	True-G
Trail	OFF	

4.7 How to Display AIS Target Data

You can display an AIS target's data by selecting it on the display.

4.7.1 AIS pop-up information

The AIS pop-up shows abbreviated AIS data (COG, SOG, CPA, TCPA and destination*) for the selected AIS target. Simply put the cursor on the AIS target to show the pop-up. The pop-up can be enabled or disabled with [AIS POP-UP INFO] in the [TT•AIS SYMBOL] menu.

VESSEL B
COG: 090.0° T
SOG: 14.00kn
CPA: 57.06NM
TCPA: 76:36
DEST: DESTIN...

*: Not displayed in CHART for RADAR mode.

4.7.2 Basic AIS target data

From the Control Unit

1. Use the trackball to put the cursor on the activated AIS target symbol you want to know its data.
2. Press the **TARGET DATA** key.
3. The selected target is marked with a broken square and AIS data is shown in the AIS data box when the target is correctly selected.

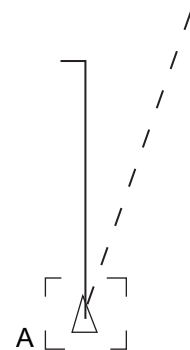

By the trackball module

Click the activated AIS target symbol. The selected target is marked with a broken square and AIS data is shown in the AIS data box when the target is correctly selected.

AIS no. (information display order) →	AIS A		↓	↑	×
Vessel name →	FURUNO				
Bearing →	BRG 136.4° T	HDG	← Heading		
Range →	RNG 8.576NM	040.0° T			
Course over ground →	COG 040.0° T	ROT	← Rate of turn		
Speed over ground →	SOG 10.00kn	+000.0° /min			
CPA →	CPA 5.726NM				
TCPA →	TCPA -32:59				
Bow crossing range →	BCR -11.88NM	STATUS			
Bow crossing time →	BCT -20:12	Underway			
Position →	50° 58.8600' N		← Navigation status*		
	001° 30.3181' E		using engine		

*: Where the selected AIS target is an aircraft, the STATUS box shows the aircraft's altitude.

Note 1: AIS is not available in dead reckoning when the radar type is selected to [IMO] on the [INSTALLATION] menu.

Note 2: If the TCPA value is negative, this means that you have already passed the closest point and the AIS target is going away from your ship.

Note 3: For the maximum displayable number of TT•AIS boxes, see section 3.8.1.

4.7.3 Expanded AIS data

The expanded AIS data display provides additional information about an AIS target, including call sign, MMSI No., IMO No., etc. To display expanded AIS data, show the basic data for a target, right-click the target data display then select [Expanded AIS Data].

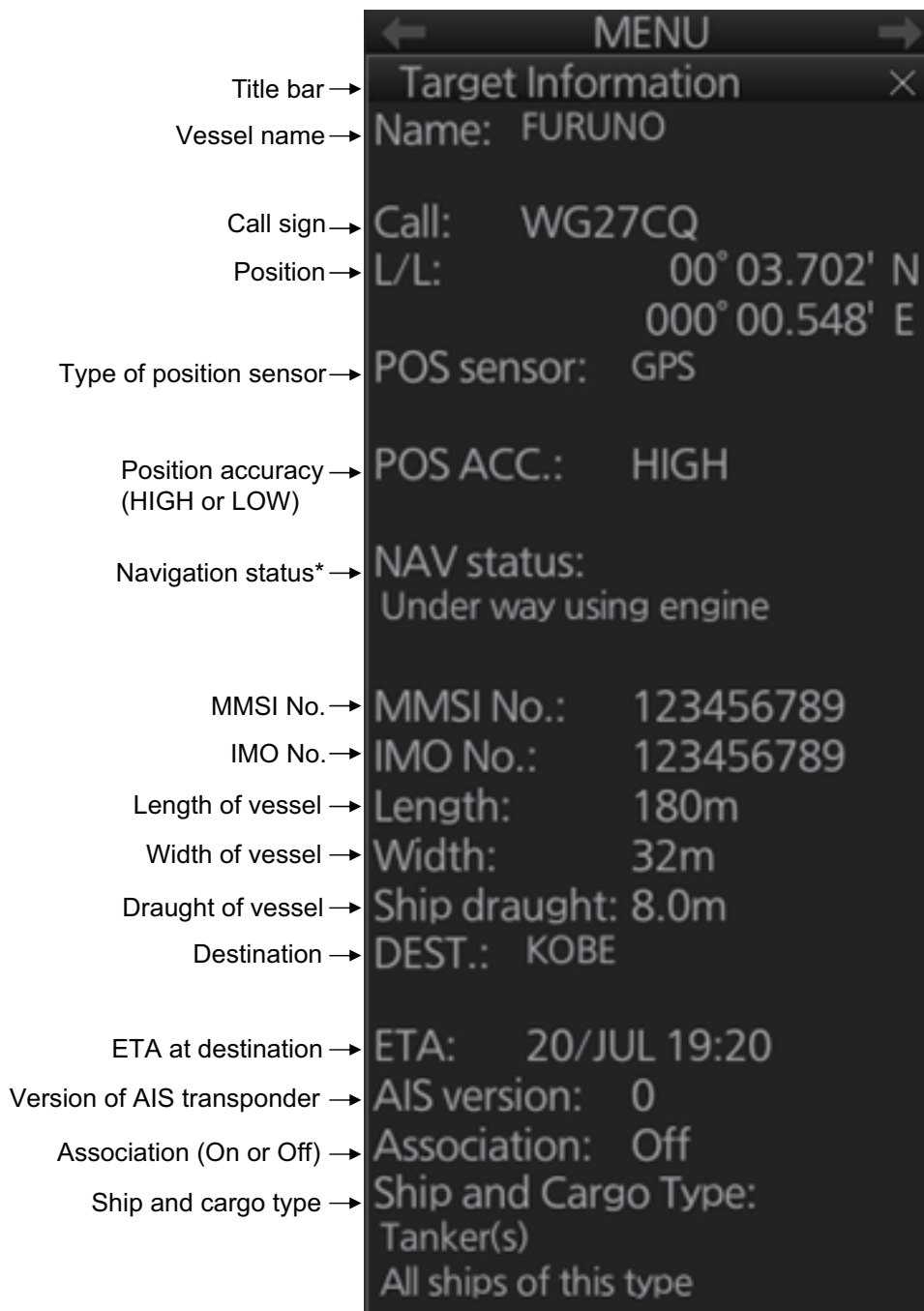

*: Where the selected AIS target is an aircraft, the STATUS box shows the aircraft's altitude.

If data for an item is unknown, "missing" appears. In the example above, the name of the position sensor is "missing".

4.8 AIS CPA/TCPA Alarm

This radar calculates CPA and TCPA by using own ship and relative target positions. An AIS dangerous target is one whose CPA and TCPA are within the range of the CPA and TCPA limits set in the TT/AIS box. The AIS symbol of an AIS dangerous target is red and flashing, and is announced with the Alert 536 (ALF format: 191,2) "AIS CPA/TCPA". After the alert is acknowledged the target symbol is displayed in red color.

To set the CPA and TCPA ranges, do the following:

1. If the CPA and TCPA settings are not shown, click [CPA/TCPA].
Note: When clicking [CPA/TCPA], the CPA/TCPA alarm function is off.
2. Click the CPA indication to select desired CPA range.
3. Click the TCPA indication to select desired TCPA setting.

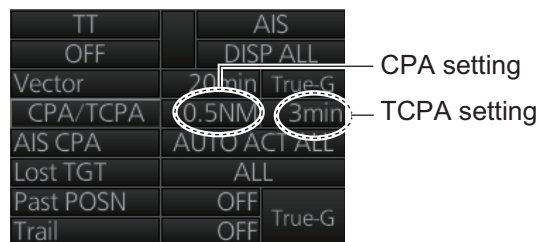

4.9 AIS Symbol Brilliance

1. Right-click the [BRILL] button on the InstantAccess bar™ then select [Brill Menu].
2. Go to page 2, select [5 AIS SYMBOL] then spin the scrollwheel to adjust the brilliance.

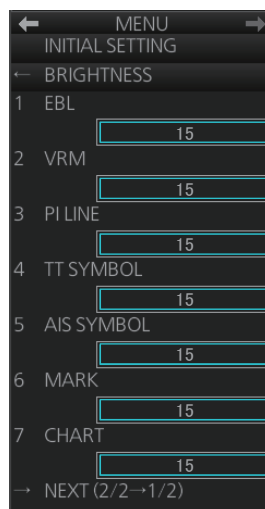

3. Close the menu.

4.10 AIS Symbol Color

1. Right-click the AIS mode indication then click [Symbol Menu] to show that menu.

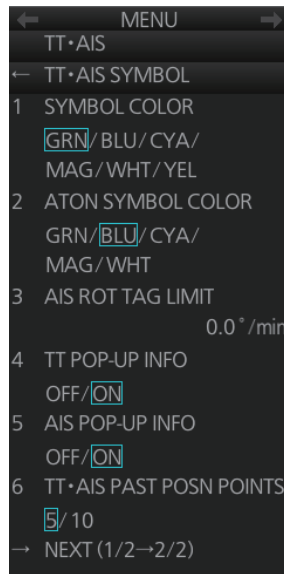

2. Select [1 SYMBOL COLOR] and desired color. (Yellow is not available with the IMO type.)
3. Close the menu.

4.11 AIS Lost Targets

An AIS target is declared a lost target when it fails to produce data for intervals which are based on the table on page 4-1. When this occurs, the target is marked with the lost target symbol (flashing), shown in the right figure, the buzzer sounds (for activated targets only) and the Alert 537 (ALF format: 193,3) "AIS Lost" appears.

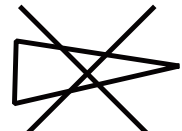

To acknowledge a lost target, push the **ALARM ACK** key or click the [Alert] box.

Note: The AIS data transmission interval depends on target's speed. For example, the data is transmitted every 10 seconds on the ship speed of 0 to 14 kn and every two seconds on the ship speed of more than 23 knots. For details, see the owner's manual of the AIS transponder.

4.11.1 How to enable, disable the AIS lost target alert

The [Lost TGT] indication (at the bottom-right position) enables, disables the lost target alert. Click the indication to select [OFF], [FILT] or [ALL] as appropriate.

[OFF]: Disable the lost target alert.

[FILT]: Get the alert against the targets whose criteria meet the settings made in section 4.11.2.

[ALL]: Get the alert against all lost targets.

TT	AIS	
OFF	DISP ALL	
Vector	20min	True-G
CPA/TCPA	0.5NM	3min
AIS CPA	AUTO ACT ALL	
Lost TGT	ALL	
Past POSN	OFF	True-G
Trail	OFF	

Note: The [Lost TGT] setting is shared commonly between TT and AIS.

4.11.2 How to set the AIS lost target filter

If you are in an area where AIS targets often become lost, the lost target alert may activate frequently. In this case, you may want to specify which targets to classify as lost targets, to prevent frequent triggering of the lost target alert.

1. Right-click the AIS mode indication then click [AIS Menu] to show that menu.
2. Open the [6 LOST FILTER] menu.
3. Set each menu item, referring to the description below.
 - [1 MAX RANGE]: Set the maximum range to use. Any AIS target at a distance greater than set here will not trigger the lost target alert.
 - [2 MIN SHIP SPEED]: Set the minimum speed to use. Any AIS target whose speed is slower than set here will not trigger the lost target alert.
 - [3 EXCEPT CLASS B]: Select [ON] to exclude class B AIS targets from the lost target alert.
4. Close the menu.

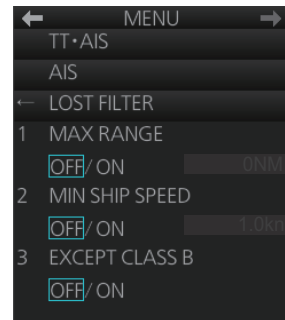

4.12 How to Display AIS Target Past Positions

The past position display shows equally time-spaced dots marking past positions of activated AIS targets. If a target changes its speed, the spacing will be uneven. If it changes course, its plotted course will not be a straight line.

Below are sample past position displays.

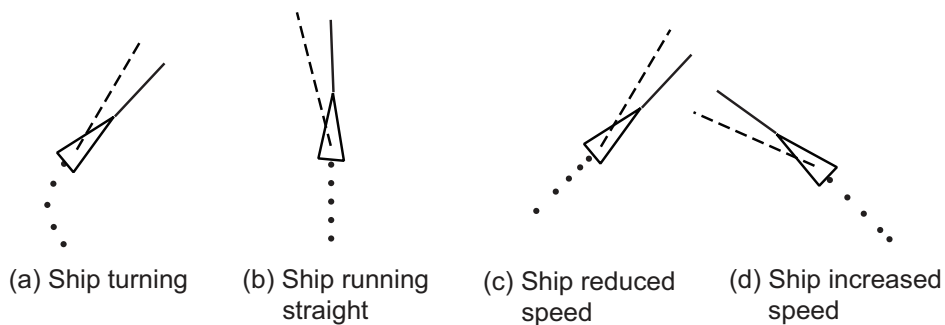

4.12.1 How to enable/disable the past position display, select past position reference

Click the indications circled in the figure below to set the plot interval (or disable the display) and the past position reference (true or relative).

TT	AIS	
OFF	DISP ALL	
Vector	20m	True G
CPA/TCPA	0.5NM	3min
AIS CPA	AUTO	ACT ALL
Lost TGT	ALL	
Past POSN	OFF	True G
Trail	OFF	

Plot interval, past position display ON/OFF

Past position reference

4.12.2 Past position points

You can show 5 or 10 past position points per AIS target. Right-click the past position indication then click [Past POSN Menu] to show that menu. Set [6 TT•AIS PAST POSN POINTS] to [5] or [10].

4.13 How to Display True or Relative Speed Vectors

AIS targets vector can be displayed relative to your ship's heading (relative) or with reference to the North (True).

Vector time (or the length of vectors) and presentation mode can be set at the bottom-right position on the screen. For further information, see section 3.9.

4.14 Association of TT and AIS Targets

An AIS-equipped ship is usually displayed by two symbols on the radar display. This is because the AIS ship position is measured by a GPS navigator (L/L) whereas the radar detects the same ship by PPI principle (range and bearing relative to own ship radar antenna).

To avoid the presentation of two target symbols for the same physical target, use the "association" function. If target data from both AIS and TT are available and if the association criteria are fulfilled, either the AIS or TT symbol is presented according to the association method selected.

Association will not happen between AIS and TT if the AIS target is sleeping or the AIS target is lost.

All association settings, including ON/OFF, can also be controlled from the chart for radar mode, with the [TT/AIS] page in the [Overlay/NAV Tools] box. All settings are mutually shared.

4.14.1 How to select association method

Click the location circled below to show "<" to select AIS symbol for associated target, or ">" to select TT symbol for associated target. This setting overrides the corresponding item on the [TT•AIS] menu. To turn off association, click the location to remove the arrow.

TT	AIS	
MAN	<	DISP ALL
Vector	20min	True-G
CPA/TCPA	0.5NM	3min
AIS CPA	AUTO ACT ALL	
Lost TGT	ALL	
Past POSN	OFF	True-G
Trail	OFF	True-G

TT	AIS	
MAN	>	DISP ALL
Vector	20min	True-G
CPA/TCPA	0.5NM	3min
AIS CPA	AUTO ACT ALL	
Lost TGT	ALL	
Past POSN	OFF	True-G
Trail	OFF	True-G

Note: You can also select the method by right-clicking the location. Click desired association method.

Association: OFF
Association: TT
Association: AIS
[Association Menu]

4.14.2 How to set the conditions for association

1. Open the menu then select [TT•AIS] and [6 ASSOCIATION].
2. Enter the association conditions, referring to the following:
 - [1 ASSOCIATION TGT]: Disable Association with [OFF], or select [AIS] or [TT]. [AIS] selects the AIS symbol for association target; [TT] selects the TT symbol for the association target.
 - [2 GAP]: Range between AIS target and TT.
Setting range: 0.000 to 0.050(NM)
 - [3 RANGE]: Enter the range difference from own ship to AIS target and TT.
setting range: 0.000 to 0.100(NM)
 - [4 BEARING]: Enter the bearing difference from own ship to AIS target and TT.
Setting range: 0.0 to 9.9(°)
 - [5 SPEED]: Enter the speed difference between AIS target and TT.
Setting range: 0.0 to 6.0(kn)
 - [6 COURSE]: Enter the course difference between AIS target and TT.
Setting range: 0.0 to 25.0(°)

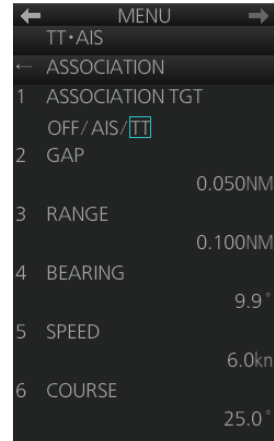

When the association criteria are met either the AIS or TT symbol is erased according to association made in section 4.14.1.

4.15 Voyage Data

Before you embark on a voyage, set your navigation status, ETA, destination, draught and the number of crew, on the [VOYAGE DATA] menu.

1. Click the [OWN AIS] button on the InstantAccess bar™ to show the [VOYAGE DATA] menu.

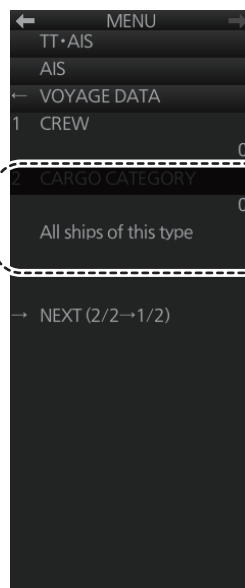

Display of [2 CARGO CATEGORY] and [All ships of this type] is dependant on the settings for the connected AIS transponder.

4. AIS OPERATION

2. Select [1 NAV STATUS] then use the scrollwheel to set the applicable two-digit nav status code, referring to the table below.

No.	Nav status	No.	Status
00	Underway using engine	08	Under way Sailing
01	At anchor	09	Reserved for high speed craft
02	Not under command	10	Reserved for wing in ground
03	Restricted Maneuverability	11	power-driven vessel pushing ahead or towing alongside (regional use)
04	Constrained by her draught	12	power-driven vessel towing astern (regional use)
05	Moored	13	Reserved for future use
06	Aground	14	AIS SART (Active)
07	Engaged in fishing	15	Not Defined

3. Select [2 ETA] then use the scrollwheel to enter ETA: day (two digits), month (two digits), year (four digits) and time (four digits).
4. Select [3 DESTINATION] then use the software keyboard to enter the name of your destination, using a maximum of 20 characters.
5. Select [4 DRAUGHT] then use the scrollwheel to enter ship's draft (0.0 - 25.5 (m)).
6. On page 2, select [1 CREW] then use the scrollwheel to enter the number of crew (0-8191).
7. Where required, spin the wheel to enter the appropriate [CARGO CATEGORY], referring to the table below.

No.	Cargo Type	No.	Cargo Type
0	All ships of this type	5	Reserved for future use
1	Carrying DG, HS, or MP, IMO hazard or pollutant category X	6	Reserved for future use
2	Carrying DG, HS, or MP, IMO hazard or pollutant category Y	7	Reserved for future use
3	Carrying DG, HS, or MP, IMO hazard or pollutant category Z	8	Reserved for future use
4	Carrying DG, HS, or MP, IMO hazard or pollutant category OS	9	No Additional Information

8. Close the menu.

4.16 AIS Messages

You can send and receive messages via the VHF link, to a specified destination (MMSI) or all AIS-equipped ships within communication range of your ship. Messages can be sent to warn of safety of navigation, for example, an iceberg sighted. Routine messages are also permitted. Short safety-related messages are only an additional means to broadcast safety information. They do not remove the requirements of the GMDSS.

4.16.1 How to create and transmit a new AIS message

You can create and send an AIS message as follows:

1. Right-click the AIS mode indication then click [AIS Menu] to show that menu.
2. Open the [8 TRANSMIT MESSAGE] menu.
3. At [1 ADDRESS TYPE], select [ADDRESSED] to send the message to a specific AIS-equipped ship, or [BROADCAST] to send the message to all AIS-equipped ships within VHF communication range. For [ADDRESSED], enter MMSI of ship at [3 MMSI No.].
4. At [2 MESSAGE TYPE], select [SAFETY] for safety message, or [BINARY] for routine message.
5. At [4 CHANNEL], select the channel over which to broadcast your message. The choices are [A], [B], [A or B] or [A and B].
6. Click [NEXT] to go to the next page.
7. Select [3 EDIT]. A text input box appears together with the software keyboard. Use the software keyboard to enter your message. The number of characters that may be entered depends on message type, and the number of characters available appears below the text box.
 Safety message broadcast: 90 characters
 Binary message broadcast: 86 characters
 Safety message addressed to MMSI: 85 characters
 Binary message addressed to MMSI: 80 characters
8. To save the file, select [2 SAVE FILE].
9. To transmit the message, click [4 TRANSMIT MESSAGE]. The confirmation message "Attention: Do you wish to transmit AIS message?" appears. Click the [OK] button to transmit the message.

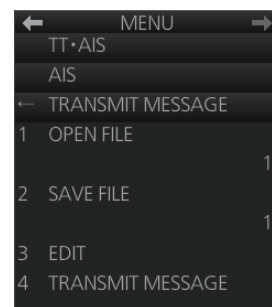
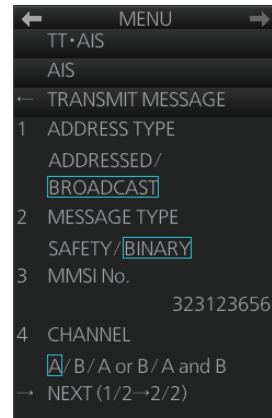

If the message could not be transmitted, the Alert 541 (ALF format: 10540,2) "AIS Message Transmit Error" appears.

4.16.2 How to transmit a saved AIS message

If you have saved some previously transmitted AIS messages, you can edit one and send it as follows:

1. Right-click the AIS mode indication then click [AIS Menu] to show that menu.
2. Open the [8 TRANSMIT MESSAGE] menu.
3. Go to page 2 of the menu, select [1 OPEN FILE] then select the number of the message to transmit.
4. Select [3 EDIT] to edit the message.
5. To save the message, select [2 SAVE FILE].
6. To transmit the message, select [4 TRANSMIT MESSAGE]. The confirmation message "Attention: Do you wish to transmit AIS message?" appears. Click the [OK] button to transmit the message.

4.16.3 How to display received AIS messages

When you receive an AIS message, the Alert 539 (ALF format: 10540,1) "AIS Message Received" appears.

To display the message, click the [AIS message] button on the InstantAccess bar™.

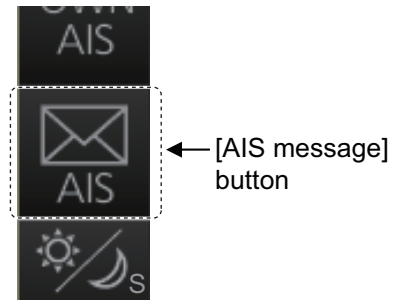

How to get notification of AIS message reception with the [AIS message] button

Right-click the AIS mode indication then click [AIS Menu] to show that menu. Go to page 2 and set [1 AUTO DISP MESSAGE] to [ON]. When you receive an AIS message, the [AIS message] button is displayed in orange.

AIS Received Messages list

Received AIS messages are stored in the AIS received message list. A maximum of 200 messages are saved over 50 pages for FURUNO 19-inch monitor unit, 34 pages for FURUNO 23-inch monitor unit.

1. Right-click the AIS mode indication then click [AIS Menu] to show that menu.
2. Select [7 RECEIVED MESSAGES].

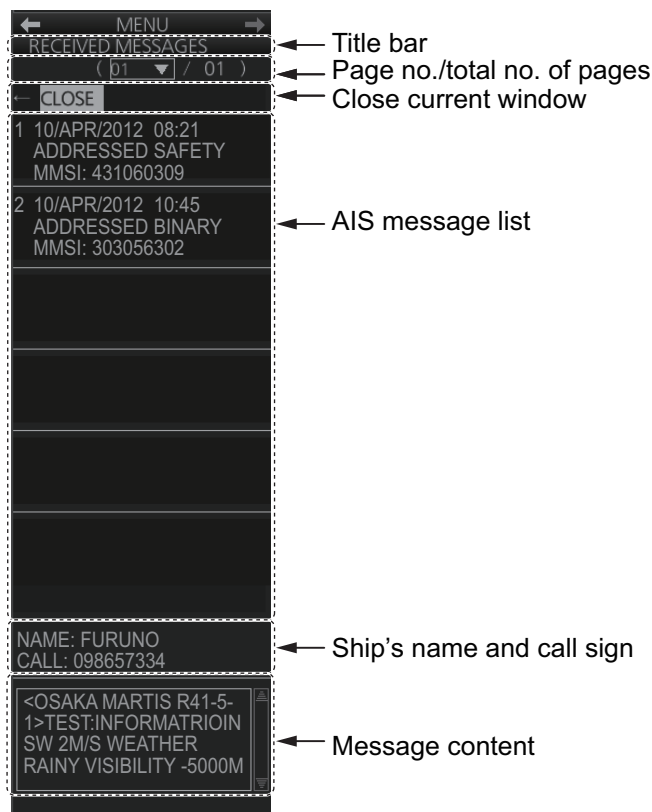

3. Click an AIS message in the list to show its contents.
4. Click the [CLOSE] window button to close the window.

4.17 How to View Own Ship Data

Own ship's static data (type of ship, call sign, MMSI, name and position of external GPS antenna) can be viewed as follows:

1. Right-click the AIS mode indication then click [AIS Menu] to show the AIS menu.
2. Select [STATIC DATA].

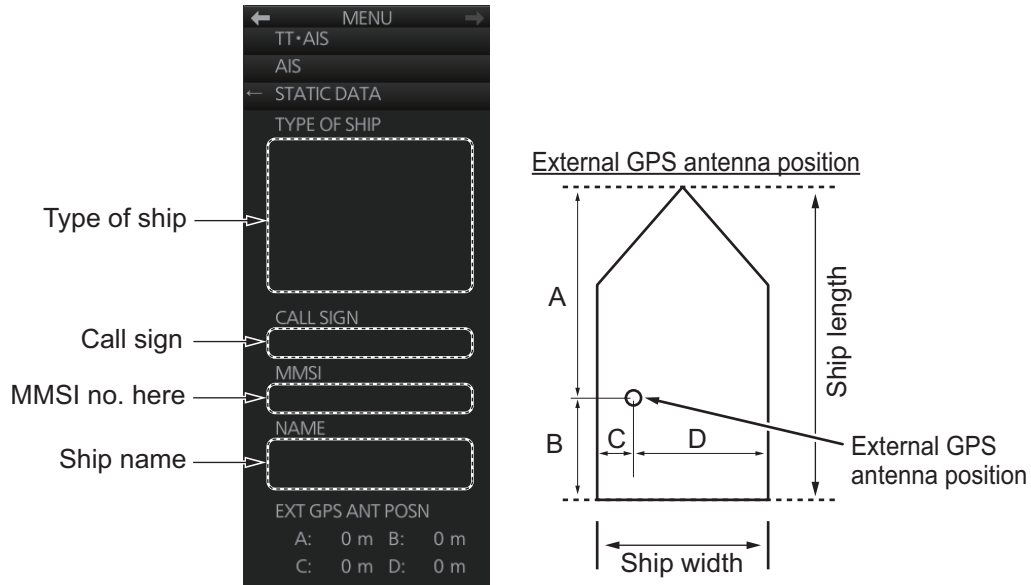

3. Close the menu.

4.18 Other AIS Features

The [TT•AIS SYMBOL] menu additionally provides the features described below.

To show the [TT•AIS SYMBOL] menu, right-click the AIS mode indication on the bottom-right of the screen then select [Symbol Menu].

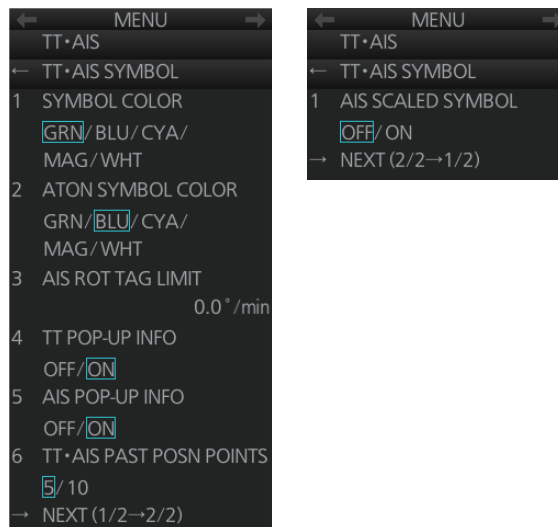

Page 1

Page 2

[2 ATON SYMBOL COLOR]: Select the ATON symbol color.

4. AIS OPERATION

[3 AIS ROT TAG LIMIT]: The ROT marker appears on the heading line of an AIS target and points in the direction of the turn when the ship's rate of turn is greater than that set here.

[1 AIS SCALED SYMBOL]: The AIS target symbol can be shown as a simple triangle or a symbol scaled according to a vessel's dimensions. Select [ON] to show the scaled symbol.

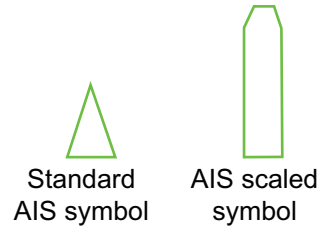

5. RADAR MAP AND TRACK

5.1 What is a Radar Map?

A radar map consists of a layer of marks and lines overlaid on the radar display. A map is intended for indicating safety-related areas and objects. Ten radar maps can be made and each map can have a total of 4,000 lines and marks. The map data can be saved to facilitate repeated use on a routine navigation area. The user can create a radar map in real time while using the radar for navigation or at leisure time at anchor or while the radar is not being used. Waypoints, events and user charts from the chart can be shown or hidden on the radar map display.

The radar map does not affect any radar function.

5.2 Presentation Modes

Six presentation modes are available: North-up, Course-up, Head-up, STAB Head-up, Stern-up and North-up TM. To select a mode, use the **MODE** key on the Control Unit or click the [Range/Presentation mode] box.

Note: Chart data is not displayed in the Head-up and STAB Head-up modes.

5.3 How to Show, Hide the Radar Map Display

Click the [MAP ON/OFF] button to display [MAP ON] or [MAP OFF] as appropriate.

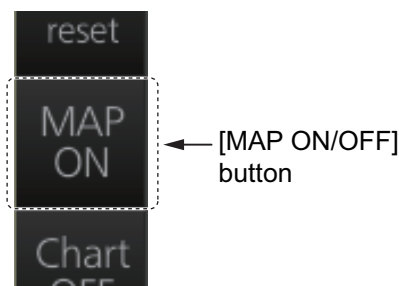

5.4 How to Enter Radar Map Marks and Lines

Marks and lines can be entered in the radar mode. (Marks cannot be entered in the chart radar mode.) These marks and lines can be displayed in red, green, blue, cyan, magenta, yellow or white. (Some marks, lines and colors may not be available depending on the specifications of your radar.)

The capacity for map storage is 10 maps/4,000 points per map. When 4,000 marks and lines have been entered into a map, the message "MARK FULL" replaces the mark icon in the [Mark] box and no more marks and lines can be entered into that map. In this case save the marks/lines to another map file or erase some marks from the full map file in order to save the mark.

The procedure below shows how to enter a mark, including mark selection, mark entry method, and save location. You can skip steps in the procedure where it is not necessary to complete the corresponding action.

1. Put the cursor on the mark shown in the [Mark] box at the bottom-left position on the display.

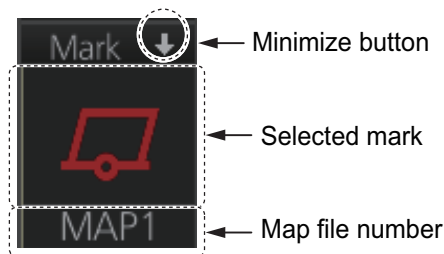

2. Spin the scrollwheel to select a mark. The name of the mark appears to the right of the mark.



3. Select mark color (B-type only), mark position, and where to save the mark as follows:

- 1) Right-click the [Mark] box to show the context-sensitive menu then click [Mark Color].

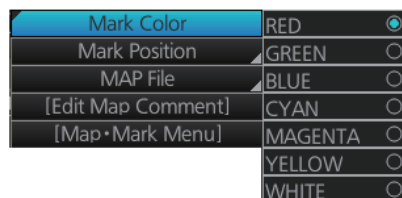

- 2) Click the mark color desired.
- 3) At the context-sensitive menu, click [Mark Position] to select the mark input method. The choices are [CURSOR], [OWN SHIP] and [L/L].

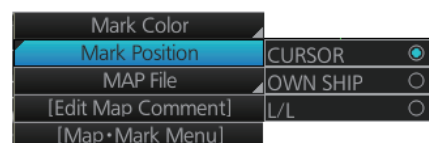

For L/L, the mark is entered at the L/L position entered at [MAP MARK L/L] on the [MAP•MARK] menu.

- 4) At the context-sensitive menu, click [MAP File] then click the map file number where to save the mark.

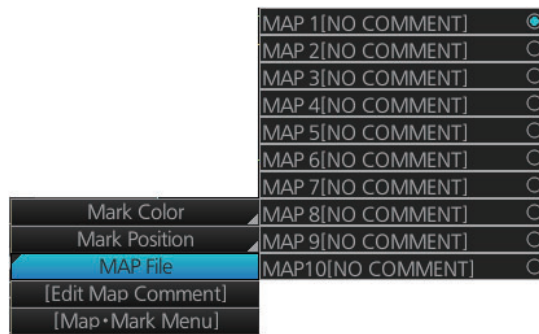

4. **For entry with the cursor**, use the trackball to put the cursor on the location desired. (You can see the range and bearing from own ship to the cursor location by monitoring the Cursor position box.) Push the left button or the **MARK** key on the Control Unit to inscribe the mark or line point.

Note: To continue entering the same mark or line under the same conditions, do the following at the next time of entry.

Entry by cursor: Click the location where to put a mark.

Entry by ship's position, or manual input of latitude and longitude: Click the mark icon.

5.5 How to Find Number of Map Points Used

You can show the number of points used in each radar map file.

Right-click the [Mark] box then select [Map•Mark Menu]. See [MARK POINTS] at the bottom of the menu to see how many mark points have been used per map file. In the example below 7 points out of 4,000 points have been used in Map 1.

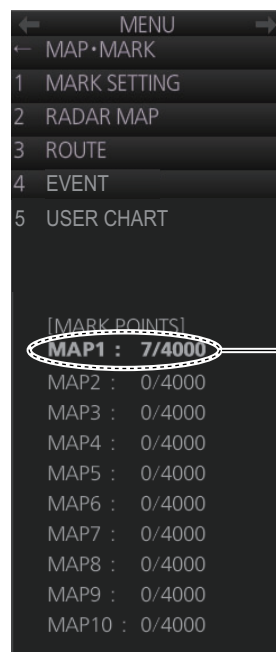

Map no., no. of points used/total no. of points

5.6 How to Select the Radar Map to Display

1. Right-click the [Mark] box to show the context-sensitive menu.
2. Click [MAP File] and then click the map no. you want to display.

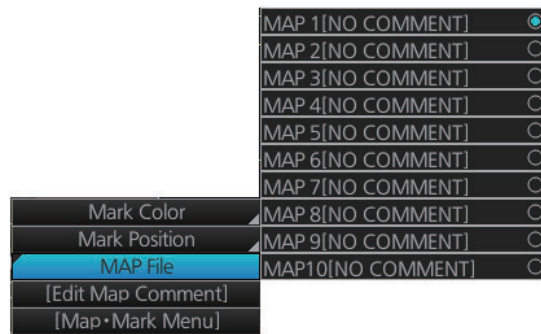

5.7 How to Attach a Comment to a Radar Map, Find Comment for a Map

5.7.1 How to attach a comment to a radar map

You can attach a comment to radar maps you have created, to help you distinguish your maps.

1. Right-click the [Mark] box to show the context-sensitive menu.
2. Click [Edit Map Comment]. A text input box appears together with the software keyboard, as shown in the right figure.
3. Select the map no. with the [Radar map file] drop-down list.
4. Enter your comment in the text input box. The number of characters available appears below the box.
5. Click the [OK] button to finish.



5.7.2 How to find the comment for a map

Put the cursor on the map no. indication. The comment is displayed to the right of the map no. In the example below the comment is "Kobe".

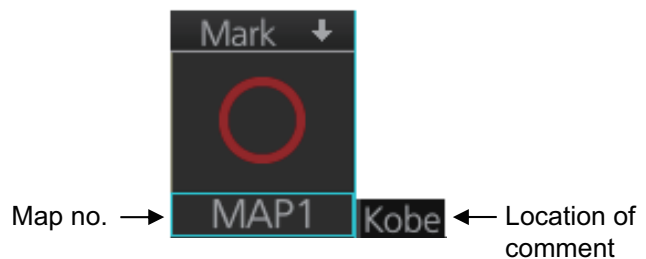

5.8 How to Erase Radar Map Marks and Lines

A total of 4,000 marks and lines is allotted per map. When this amount is exceeded in a map, no more map marks or lines may be entered into the map unless you erase some unnecessary marks or lines.

5.8.1 How to erase individual radar map marks and lines

1. Right-click the display area to show the context-sensitive menu.

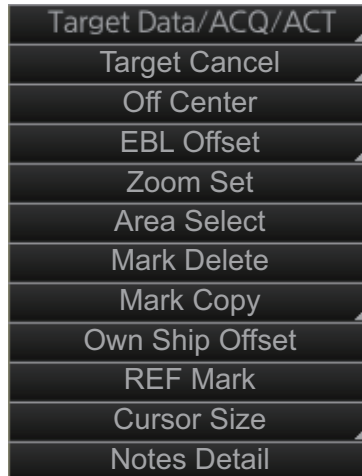

2. Click [Mark Delete].
3. Click the mark or line to erase.

5.8.2 How to erase map marks and lines in an area

You can erase all marks and lines within an area as follows:

1. Right-click the display area to show the context-sensitive menu.

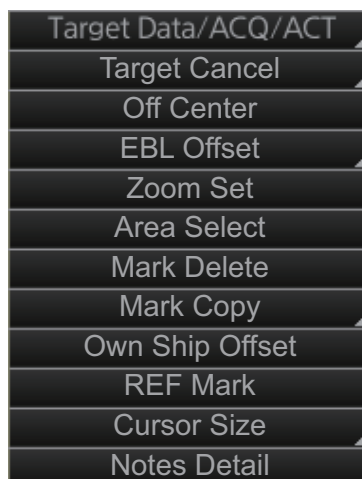

2. Click [Area Select].

5. RADAR MAP AND TRACK

3. Specify the area as follows:

- 1) Put the cursor on the start point and push the left button.
- 2) Drag the cursor diagonally to the end point and push the left button.

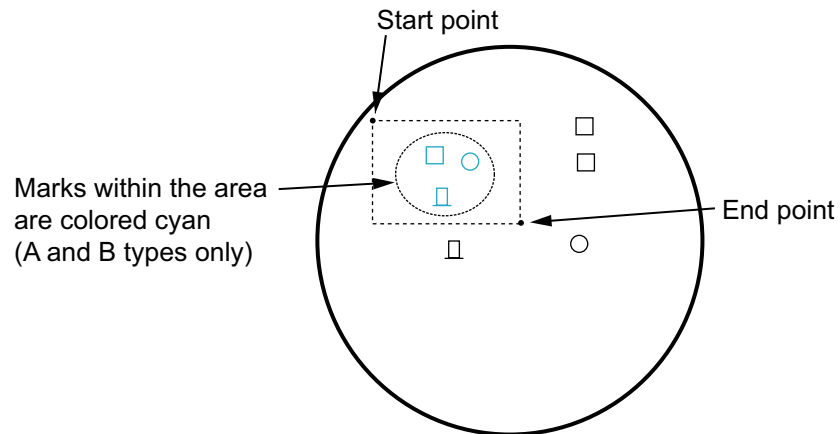

4. Right-click the display area to show the context-sensitive menu.

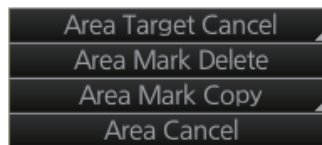

5. Click [Area Mark Delete] to delete the marks and lines in the area selected.

5.8.3 How to erase all radar map marks and lines in a map file

You can erase all radar map marks and lines in the map file currently displayed. Be absolutely sure you want to erase the marks and lines - erased marks and lines cannot be restored.

1. Right-click the [Mark] box, select [Map•Mark Menu] and [1 MARK SETTING].
2. Select [8 MAP MARK ALL DELETE]. The confirmation message "Attention: Do you wish to delete all map mark?" appears. Click the [OK] button to erase all marks and lines.
3. Close the menu.

5.9 How to Copy Radar Map Marks and Lines

5.9.1 How to copy individual radar map mark and line to another map file

You can copy individual mark and line from the currently displayed radar map to the radar map file of your choice.

1. Right-click the display area to show the context-sensitive menu.
2. Click [Mark Copy] then click the map file no. where to copy the mark.

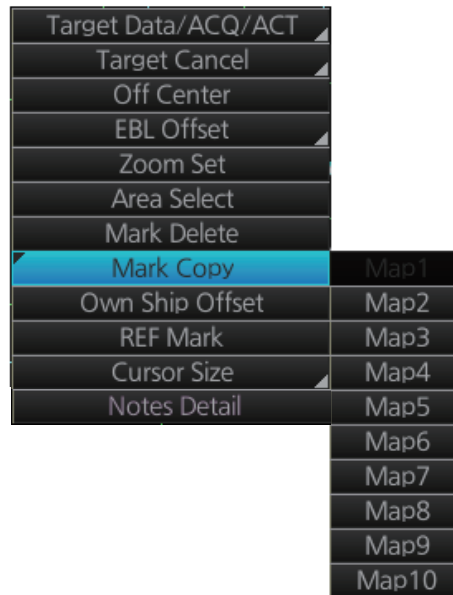

3. Put the (light-blue) cursor on the mark or line then click.

5.9.2 How to copy radar map marks and lines within an area to another map file

You can copy radar map marks and lines within an area of the currently displayed radar map to the radar map file of your choice.

1. Right-click the display area to show the context-sensitive menu.
2. Click [Area Select].
3. Specify the area as follows.
 - 1) Put the cursor on the start point and push the left button.
 - 2) Drag the cursor diagonally to the end point and push the left button.
All marks and lines within the area selected are highlighted in blue (A and B types only).
4. Right-click to show the context-sensitive menu.



5. Click [Area Mark Copy] then click the map file number where to copy the marks and lines.

5.9.3 How to copy all radar map marks and lines in a map file to another map file

You can copy all radar map marks and lines in the currently displayed radar map to the radar map file of your choice.

1. Display the map file of which to copy all its marks and lines. See section 5.6.
2. Right-click the [Mark] box then click [Map•Mark Menu].
3. Select [1 MARK SETTING].
4. Select [9 MAP MARK ALL COPY].

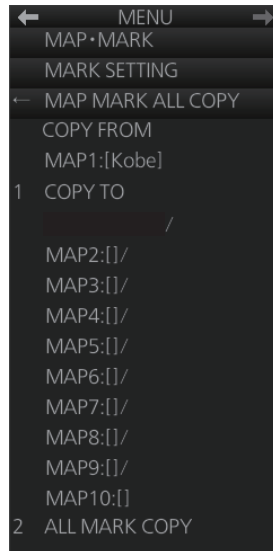

5. Select [1 COPY TO] then select where to copy the map marks and lines.
6. Select [2 ALL MARK COPY]. The confirmation message "Attention: Do you wish to copy all map mark?" appears. Click the [OK] button to copy.
7. Close the menu.

5.10 How to Export Radar Map

You can export a radar map to a USB flash memory. For safety, only export radar maps while the radar is in standby.

1. Set the USB flash memory in the USB port on the Control Unit.
2. Open the menu then select the [5 MAP•MARK] and [1 MARK SETTING] menus.
3. Go to page 2 of the menu, select [1 MAP MARK MANAGE]. The confirmation message appears.

Note: The [1 MAP MARK MANAGE] menu appears only when the radar is in standby.

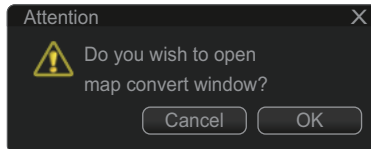

4. Click the [OK] button to show the [Map Convert] dialog box.

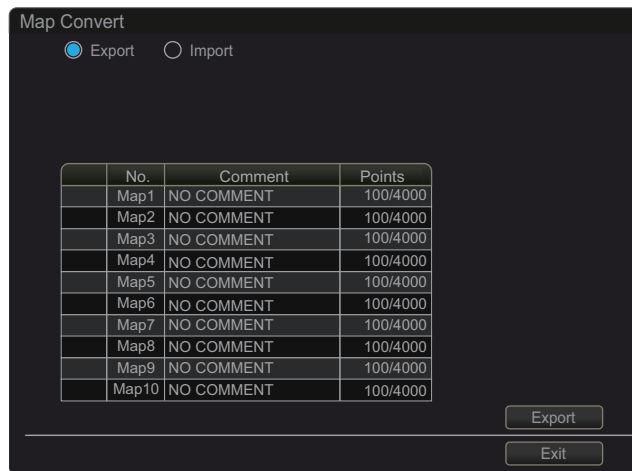

5. Check [Export] at the top-left position of the dialog box.
6. Check the radar map(s) (Map1 to Map10) to export.
7. Click the [Export] button to show the [Save file] dialog box.
8. Select the USB flash memory as the destination to save then click the [Save] button. After the data export is completed, the message "x file(s) have exported success." appears (x is the number of the radar map(s)).
9. Click the [OK] button.

5.11 How to Import Radar Map

You can import a radar map created on another equipment (FCR-2xx9, FAR-3xx0 or FAR-2xx7). For safety, only import radar maps while the radar is in standby. Copy the radar maps to a USB flash memory.

1. Set the USB flash memory that contains the radar map(s) to import in the USB port on the Control Unit.
2. Open the menu then select the [5 MAP•MARK] and [1 MARK SETTING] menus.
3. Go to page 2 of the menu, select [1 MAP MARK MANAGE]. The confirmation message appears.

Note: [1 MAP MARK MANAGE] is only available when the radar is in standby.

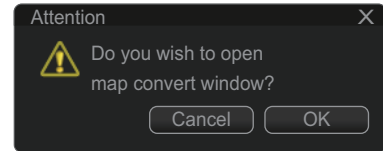

4. Click the [OK] button to show the [Map Convert] dialog box.
5. Check [Import] at the top-left position of the dialog box then click the [Select file to import] button to show the [Select file] dialog box.

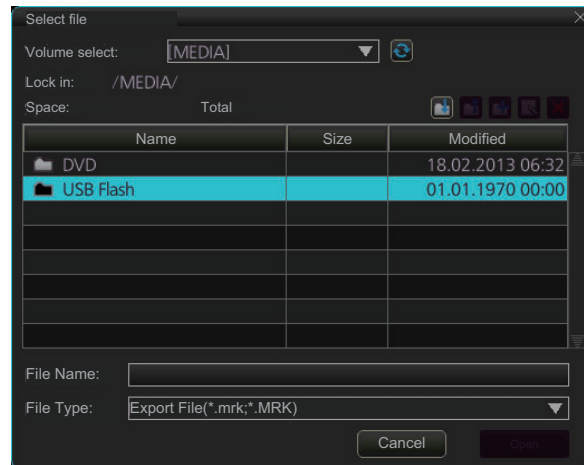

6. Select the folder that contains the file to import then click the [Open] button to show the [Map Convert] dialog box.

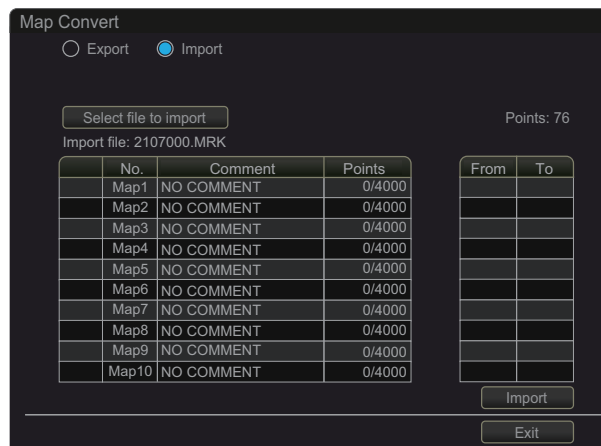

7. Check the radar map(s) (Map1 to Map10) to which the data created on another unit are imported.
8. Click the [Import] button to import the data to the radar map(s) selected at step 7.

Note: When importing a radar map created on another FAR-2xx7, the radar maps marks and lines are converted. See the tables on pages 5-11 and 5-12.

The list of the radar map marks and lines

The radar map marks and lines created on another FAR-2xx7 are converted to ones on the FAR-3xx0 series as below.

Marks

FAR-2xx7			FAR-3xx0					
Symbol	Color	Name	IMO or A type			B type		
			Symbol	Color	Name	Symbol	Color	Name
	Red	Buoy		Red	Buoy		Red	Buoy
	Green	Buoy		Green	Buoy		Green	Buoy
	Red	Buoy		Red	Buoy		Red	Buoy
	Green	Buoy		Green	Buoy		Green	Buoy
	Red	Buoy		Red	Buoy		Red	Buoy
	Green	Buoy		Green	Buoy		Green	Buoy
	Red	Buoy		Red	Buoy		Red	Buoy
	Green	Buoy		Green	Buoy		Green	Buoy
	*	Buoy		Red	Buoy		*	Buoy
	*	Buoy		Red	Buoy		*	Buoy
	*	Buoy		Red	Buoy		*	Buoy
	*	Buoy		Red	Buoy		*	Buoy
	*	Danger		Magenta	Danger		*	Danger
	*	Danger		Magenta	Danger		*	Danger
	Magenta	Danger		Magenta	Danger		Magenta	Danger
	*	Mark		Yellow-orange	Mark		*	Mark
	*	Mark		Yellow-orange	Mark		*	Mark
	*	Mark		Yellow-orange	Mark		*	Mark
	*	Mark		Yellow-orange	Mark		*	Mark
	*	Mark		Yellow-orange	Mark		*	Mark
	*	Mark		Yellow-orange	Mark		*	Mark
	*	Mark		Yellow-orange	Mark		*	Mark
Other	-	-		Yellow-orange	Mark		*	Mark

*: The display color is selectable. See "Contrast table for the display colors" on page 5-12.

Lines

FAR-2xx7			FAR-3xx0					
Symbol	Color	Name	IMO or A type			B type		
			Symbol	Color	Name	Symbol	Color	Name
••••	*	Mark	••••	Yellow-orange	Buoy	••••	*	Mark
—	*	Mark	—	Yellow-orange	Buoy	—	*	Mark
••••	*	Nav Line	••••	Magenta	Buoy	••••	*	Nav Line
▭	*	Coast Line	—	White	Buoy	—	*	Coast Line
••••	*	Contour Line	••••	Gray	Buoy	••••	*	Contour Line
▬▬▬	*	Prohibited Area	▬▬▬	Magenta	Prohibited Area	▬▬▬	*	Prohibited Area
~	*	Danger	∧∧	Magenta	Danger	∧∧	*	Danger
⊖	*	Line Buoy	—	Yellow-orange	Line Mark	⊖	*	Line Buoy
△	*	Line Buoy	••••	Yellow-orange	Line Mark	△	*	Line Buoy
⊕	*	Line Mark	••••	Yellow-orange	Line Mark	⊕	*	Line Mark
◇	*	Line Mark	••••	Yellow-orange	Line Mark	◇	*	Line Mark
Other	-	-	—	Yellow-orange	Line Mark	—	*	Mark

*: The display color is selectable. See "Contrast table for the display colors" on this page.

Contrast table for the display colors

Below is the contrast table for the display colors of the radar map marks and lines.

FAR-2xx7	FAR-3xx0
Red	Red
Yellow	Yellow
Green	Green
Cyan	Cyan
Magenta	Magenta
Blue	Blue
White	White
Other	Green

5.12 How to Show, Hide Radar Map Features

You can show or hide radar map objects as follows:

1. Right-click the [Mark] box then select [Map•Mark Menu] and [2 RADAR MAP].
2. Turn objects on or off as appropriate.
3. Close the menu.

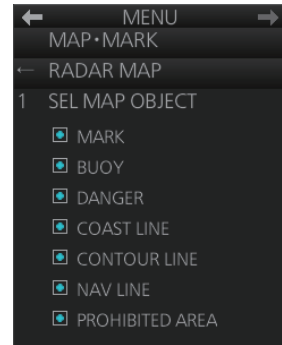

5.13 Track

5.13.1 How to set up ship's track

The track traces your ship's movement. This radar records track at the interval you set on the [OWN TRACK] menu, and the recording interval determines the maximum recording time. The longer the interval the longer the recording time, as shown in the table below.

When the memory for track becomes full, the oldest track is deleted to make room for the latest. For that reason you may want to adjust the recording interval so as to keep the track on the display for a longer time.

Save Interval	Max. Recording Time	Save Interval	Max. Recording Time
30 s	6 days 22 hr 40 min	3 min	41 days 16 hr
1 min	13 days 21 hr 20 min	6 min	83 days 8 hr
2 min	27 days 18 hr 40 min	15 min	208 days 5 hr

1. Open the menu then select the [6 CHART DISPLAY] and [1 OWN TRACK] menus.
2. Select [1 DISP OWN TRACK].
3. Select [ON] to show your ship's track or [OFF] to hide the track.
4. Select [2 OWN TRACK SOURCE].
5. Select the navigation sensor that is to feed the position data to use to plot your ship's track, among [PRIMARY], [SECONDARY] and [SYSTEM].
[PRIMARY]: Navigation sensor having first priority.
[SECONDARY]: Navigation sensor having second priority.
[SYSTEM]: Plot own ship's track using system-fed position.
6. Select [3 SAVE INTERVAL].
7. Select how often to save your ship's track, among [30s], [1min], [2min], [3min], [6min] and [15min]. [DRAW ONLY] draws the track but does not save it.
8. **For the B-type radar**, you can select the color for the track with [5 OWN TRACK COLOR].

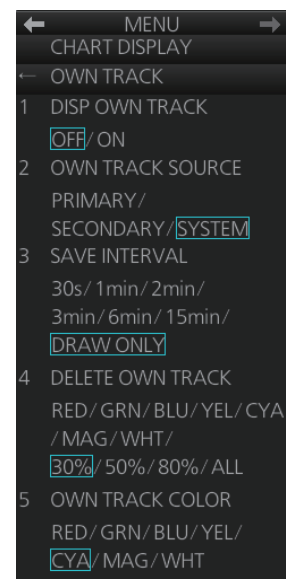

5. RADAR MAP AND TRACK

9. Close the menu.

5.13.2 How to erase track

When the display becomes filled with track, for example, your ship traces the same route several times, you may want to delete some or all of your track from the display.

1. Open the menu then select the [6 CHART DISPLAY] and [1 OWN TRACK] menus.
2. Select [5 DELETE OWN TRACK].
3. Select the color to delete (A and B types), or the percentage of track to delete among [30%], [50%], [80%] and [ALL].
4. Close the menu.

5.14 Route Display

The route selected for navigation (in the chart mode) (see chapter 12) can be shown on the radar display. You can show or hide the entire route, and show or hide elements of the route (channel limits, safety margin, leg marks and wheel over line).

1. Right-click the [Mark] box then select [Map•Mark Menu] and [3 ROUTE].
2. Turn the route display on or off at [1 DISP ROUTE].

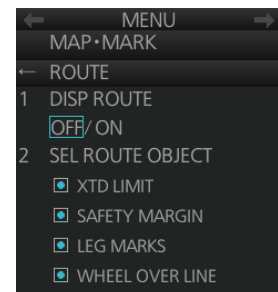

- Turn the XTD limit, safety margin, leg marks and wheel over line displays on or off at [2 SEL ROUTE OBJECT].

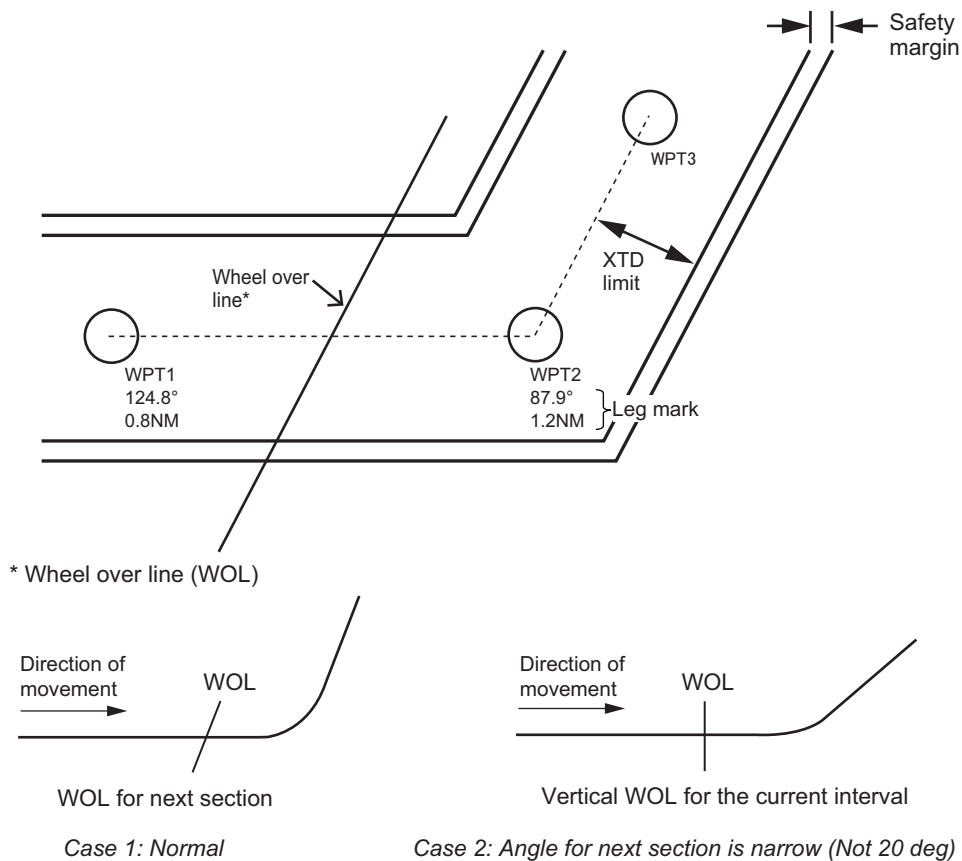

- Close the menu.

5.15 User Chart Display

The active user chart can be shown in the chart radar mode. See chapter 13 for a description of the user chart.

- Right-click the [Mark] box then select [Map•Mark Menu] and [5 USER CHART].
- Show or hide the user chart on the radar display with [1 DISP USER CHART].
- Show or hide the user chart objects on the radar display with [2 SEL USER CHART OBJECT].
- Close the menu.

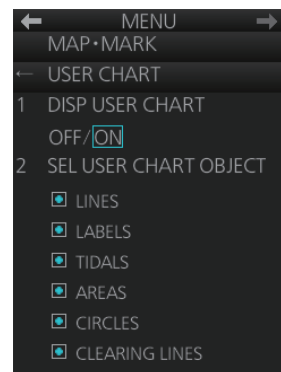

5. RADAR MAP AND TRACK

This page is intentionally left blank.

6. CHART OVERVIEW

6.1 Chart Screen Overview

The ECDIS (Electronic Chart Display and Information Systems) screen is divided into several areas, as illustrated below. (The layout may be slightly different depending on your monitor's resolution.) The ECDIS operational area has no limitations. That is, high latitudes (85° and higher) are correctly displayed always. The ECDIS uses “orthographic” presentation for areas of high latitude and small chart scales. All other conditions use the “cylindrical equidistant” presentation.

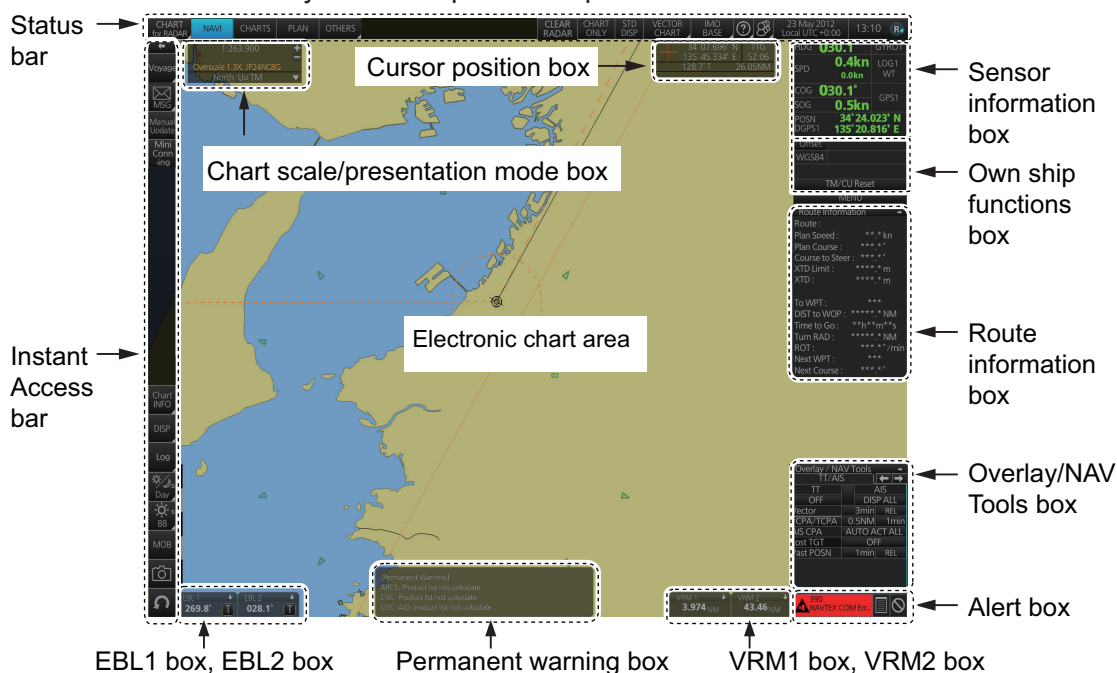

*: High latitudes are not supported in RADAR mode.

- The **Status bar** provides for selection of display mode, chart format, IMO chart display; one-click restoration of IMO standard display, etc.
- The **Sensor information box** displays ship's speed, course and position and selects sensors.
- The **Own ship functions box** applies offset to the chart.
- The **Route information box** shows route and waypoint data, when a route is selected for navigation.
- The **Overlay/NAV Tools box** provides for setup of navigation-related functions.
- The **Alert box** shows operational and system alert messages.
- The **VRM boxes** measure the range to an object.
- The **Permanent warning box** displays chart-related warning messages.
- The **EBL boxes** measure the bearing to an object.
- The **InstantAccess bar™** provides quick access to functions such as brilliance adjustment, display palette and the chart-related menu. The contents change according to the display mode selected.
- The **Chart scale/presentation mode box** selects the chart scale and presentation mode.
- The **Cursor position box** shows the latitude and longitude position of the cursor and the TTG to the cursor.
- The **Electronic chart area** shows the chart.

Note: If the display indications freeze, the buzzer sounds continuously. Restart the unit to restore normal operation.

6.1.1 Electronic chart area

This chart radar can use the following types of charts:

- S-57 (IHO)
- S-63 (IHO) (S-63 encrypted)
- C-MAP

The following information can also be displayed:

- Cursor (moved by trackball)
- Planned route
- EBL (Electronic Bearing Line) and VRM
- Own ship symbol with speed vector
- TT-acquired target from radar
- AIS target

Electronic charts

The electronic navigational charts, ENC or C-MAP vector format, are displayed in the electronic chart area.

The chart radar combines chart and navigational information. It should be noted that modern navigation systems (e.g., differential GPS) may offer more accurate positioning than what was used to position some of the surveys from which the electronic navigational chart was derived.

This chart radar is compatible with S57 release 3 ENC format charts. ENC charts are converted to SENC for use with the chart radar.

When you open a chart, it is displayed with the default scale, called the compilation scale. The details for the chart are displayed in the electronic chart area and these can be modified. You can change the chart scale with the ZOOM IN and ZOOM OUT functions, and the scale range is 1:1,000 - 1:70,000,000.

C-MAP vector format

The C-MAP charts require a contract with applicable provider. There are two types of C-MAP charts; C-MAP ENC SERVICE, which are officially recognized charts, and C-MAP PROFESSIONAL, which are charts from a private source and cannot be used as a substitute for paper charts under any condition. To emphasize this point C-MAP PROFESSIONAL charts are called "Non-ENC" charts in this manual.

Note: Some eToken dongles from the FEA-2xx7 can be used with this system. These are labeled "JeT FURUNO XXXXX". Contact your dealer for details.

This chart radar accepts the following C-MAP chart types: ENC SERVICE, PROFESSIONAL+, ENC+ SERVICE and ADMIRALTY ENC SERVICE.

C-MAP ENC SERVICE charts comply with the IHO's (International Hydrographic Organization's) S-57 Edition 3 product specification. When used in the chart radar, the ENC data improves the safety of navigation at sea.

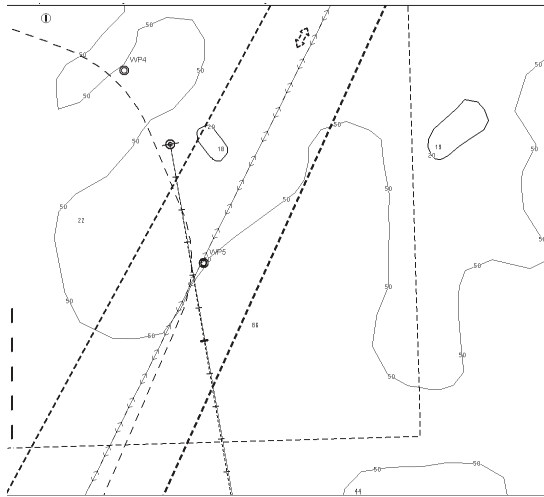

What is ENC delivery?

ENCs can be distributed as ENC delivery or SENC delivery. Both deliveries can be used in this system.

In ENC delivery, charts are distributed directly from source like PRIMAR, IC-ENC, JHA, etc. They are delivered onboard in ENC format (using S-57 and S-63) then the charts are installed into the system.

In SENC delivery, charts are converted from ENC to SENC before delivery to onboard and then installed into the system. A C-MAP ENC delivery is SENC delivery.



Important notices

- If you are using both services (ENC and SENC deliveries) having the same chart name installed into the system through both deliveries, priority of displaying the chart is in ENC delivery.
- Chart updates for ENC delivery are only for charts of ENC delivery and chart updates for SENC delivery is only for charts of SENC delivery. You have to keep charts up-to-date separately.
- If you change from ENC delivery to SENC delivery, remove old charts from the system before installing charts from new delivery.

6.1.2 Status bar

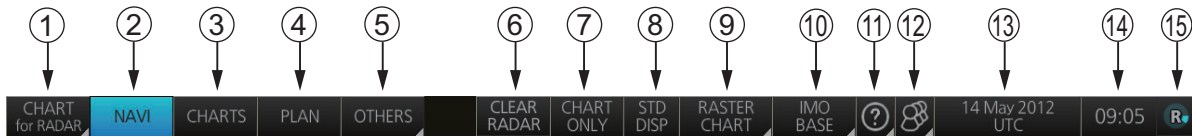

The Status bar mainly provides for selection of display mode, chart type and IMO chart display setting.



No.	Button name	Description
1	Display mode	Selects the display mode: [RADAR], [CHART for RADAR], or [CONNING for RADAR]*. *Optional specification.
2	NAVI	Selects the Voyage navigation mode.
3	CHARTS	Goes to the Chart maintenance mode.
4	PLAN	Selects the Voyage planning mode.
5	OTHERS	Sets system in silent mode.
6	CLEAR RADAR	Hides radar echoes and TT/AIS symbols. Available only when radar overlay is active, or when there is at least one TT/AIS symbol displayed.
7	CHART ONLY	Shows only the chart, when left button is pressed and held down.
8	STD DISP	Restores the IMO standard display instantly.
9	Chart priority	No use.
10	Chart database	Selects the pre-defined presentations of ENC content: IMO BASE, IMO STD or IMO ALL. CUSTOM appears when the symbols selected or deselected on the [Chart Display] menu do not match the preset conditions for IMO BASE, IMO STD or IMO ALL.
11		Displays the operator's manual, chart program no. and system information.
12	 Settings	Manages user profiles; opens the Settings menu.
13	Date	<ul style="list-style-type: none"> Displays the date. Selects the time to use, local or UTC. Sets the time difference between local and UTC (to use local time).
14	Time	Displays the time, local or UTC.
15	Working Indicator 	<ul style="list-style-type: none"> Rotates clockwise if the system is working properly. If it is not spinning the system is not working. Shortly after it stops spinning the buzzer sounds. Reset the power to restore normal operation. If the primary display mode is specified during the installation, the first letter of the mode name appears at the center of the working indicator as follows: C: Conning, E: ECDIS, R: Radar. The letter can be clicked to return to the primary display mode.

How to operate the buttons on the Status bar

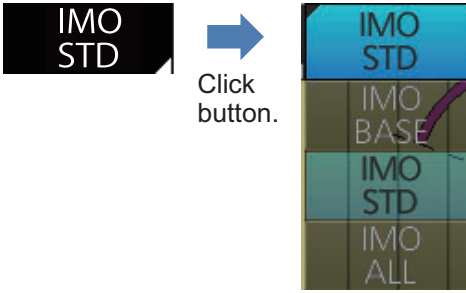

The Status bar has two types of controls: toggle button and drop-down list button. You operate the buttons with the trackball module.

Button type	Operating procedure
<p>Mode button</p> <p>A mode button selects the chart operating mode (see section 6.3). The background color of a mode button is light-blue when its chart operating mode is enabled; gray when disabled. The [NAVI] button is an example of a mode button.</p>	 <p>Click button.</p>
<p>Drop-down list button</p> <p>A drop-down list button provides a list from which to select an option related to the label on the button. The [Chart Database] button is an example of a drop-down list button. See the right figure. A drop-down list button has a list status indicator (a triangle) whose position changes according to list status.</p> <div style="display: flex; justify-content: space-around; align-items: center;"> <div data-bbox="427 853 592 958">  <p>List closed</p> </div> <div data-bbox="667 846 831 958">  <p>List opened</p> </div> </div>	 <p>Click button.</p>



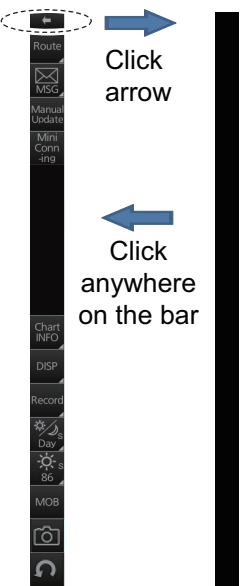

6.1.3 InstantAccess bar™

The InstantAccess bar™ runs vertically along the left edge of the screen. The bar contains all the operating functions related to the selected chart operating mode (Voyage planning, Voyage navigation and Chart maintenance). The bar is divided into two sections, upper and lower. The buttons in the lower section are common to all modes. A button with a triangle mark at its bottom right corner indicates a button with multiple functions.



Button name	Description
Voyage navigation mode bar	
←	Minimize the InstantAccess bar™. To restore the maximized bar, click anywhere on the bar. 
Voyage	<p>[Route]: Selects/deselects routes, and moves route to Voyage planning mode (for editing).</p> <p>[User Chart]: Selects/deselects user chart for monitoring.</p> <p>[Monitor INFO]: Shows the [Monitor Information] dialog box.</p> <p>[Stop Monitor]: Stops monitoring of route, user chart.</p> <p>[Instant Track]: Creates a temporary track to return to or make a temporary detour from the monitored course.</p>
	Processes AIS Safety and Navtex messages. If you have unread Navtex or Safety messages, the icon changes as shown right; "N" for unread Navtex, "S" for unread Safety, "S/N" for unread Safety and Navtex. 
Manual Update	Shows the menu for manual update of chart objects.
Mini Conning	Shows or hides the mini conning display.
Chart maintenance mode bar	
←	Minimizes the InstantAccess bar™.
Gate-1	Automatically installs selected charts and their licenses. Requires presetting at installation. Does not appear unless the presetting is done.
AUTO Import	Loads charts automatically.
Manage Charts	Deletes charts; installs (loads) charts manually.
Cell Status	Finds cell status.
License	Enters license information.
Public Key	Shows the current public key. The public key changes each time a new one is installed.
System	<p>Functions for chart synchronization and chart data management.</p> <p>Sync Config selects the ECDIS units to synchronize.</p> <p>Sync Status checks synchronization status.</p> <p>Gate-1 Config. manages Gate-1 charts. Does not appear unless the presetting mentioned at [Gate-1] above is done.</p> <p>Reconvert reconverts SENC charts.</p> <p>Clear Charts removes chart data.</p>
Voyage planning mode bar	
←	Minimizes the InstantAccess bar™.
Planning	Creates and edits routes and user charts.
Report	Displays route and user chart reports.

6. CHART OVERVIEW

Button name	Description
Guide Box	Shows or hides the guide box, which provides range and bearing measurement between waypoints when creating a route. Note: Range and bearing between waypoints can be calculated using either [Rhumbline] or [Great Circle]. Select the appropriate method from the [Guide Box] drop-down list in the [Geometry] section of the [NAV TOOLS] menu.
Manage Data	Manages routes and user charts. [Route]: Imports, exports, deletes routes. [User Chart]: Deletes user charts. [Data Import]: Imports route, user chart created with FEA-2x07 ECDIS.
Common bar	
Chart INFO	Provides chart information. [Chart Legend]: Shows chart legend, with your vessel at the center, in the Voyage navigation mode. [Viewing Dates]: Sets Display date and Update Review dates. [Chart 1]: Displays an overview of ECDIS chart symbols.
DISP	[SET]: Shows the [Basic Setting] menu, [Chart Display] menu, [Symbol Display] menu, [Chart Alert] dialog box. [TWO DISP]: Splits the screen in two, vertically or horizontally, in the Voyage navigation mode. [NtoM]: Shows or hides the Notices to Mariners (NtoM).  : Shows or hides the software keyboard.
Log	Displays Update log (ENC, C-MAP), Event log* (user event, POSN event), NAV log (Voyage, Details, Chart Usage), Target log (Danger Target), and Route Transfer log. *: Voyage navigation and Voyage planning modes.
 Palette	Selects a color palette, day, dusk or night. The S or L at the right edge of the label indicates how the color palette selection is shared, among the units of the system (S) or locally (L). The default setting is "S". See section 22.6.
 BRILL	<ul style="list-style-type: none"> Adjusts the brilliance of the monitor. Adjusts the backlighting for the control unit. (CHART for RADAR mode) The S or L at the right edge of the label indicates how the brilliance/backlighting selection is shared, among the units of the system (S) or locally (L). The default setting is "S". See section 22.6.
MOB	Inscribes the MOB (ManOverBoard) mark.
 Capture	Takes a screenshot.
 UNDO	Restores previous condition in route and user chart creation.

How to operate the buttons on the InstantAccess bar™

The InstantAccess bar™ has four types of buttons: toggle button, drop-down list button, slider bar button, and specialty button. (The [MOB], [Capture] and [UNDO] buttons are specialty buttons that provide a single-action function.) The buttons can be operated with the trackball module or the **InstantAccess** knob. This section shows you how to operate the buttons with the **InstantAccess** knob.

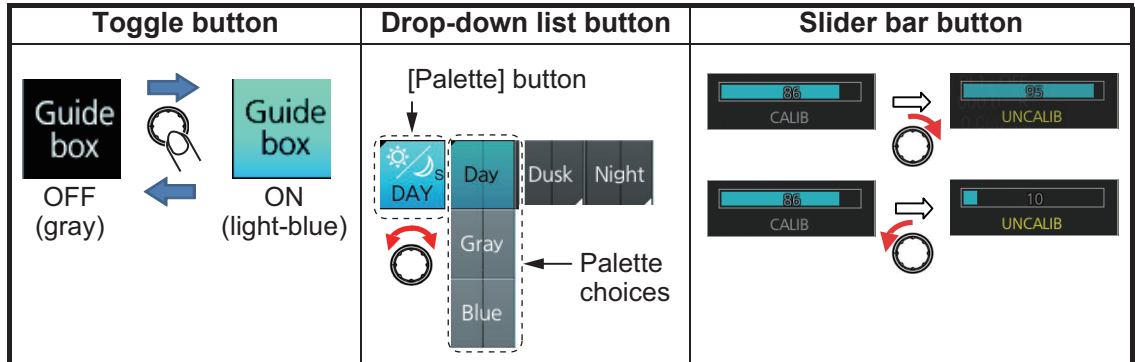

1. Push the **InstantAccess** knob to enable its use with the InstantAccess bar™.
2. Rotate the **InstantAccess** knob to select a button. The background color of the button selected is light blue.
3. Do one of the following depending on button type.
 - **Toggle button:** Push the knob to select setting.
 - **Drop-down list button** or **slider bar:** Rotate the knob to select an item or adjust the slider bar. Push the knob to confirm your selection or setting.

Note 1: You can use the **ESC** key to go back one step in the current operating sequence.

Note 2: The **InstantAccess** knob can only adjust the slider bar on the InstantAccess bar™.

6.1.4 Sensor information box

Sensor information box displays the sensor data. When the user-selected sensor fails, the system automatically selects another sensor. When this occurs, the color of the sensor name changes according to the sensor status. For details, see section 1.11.

HDG	141.0° T	GPS1
SPD	-3.0kn	GPS1
	▶ 4.6kn	BT
COG	262.7° T	GPS1
SOG	5.5kn	
POSN	35° 37.9964'N	
GPS1	139° 45.8268'E	

6.1.5 Own ship functions box

The own ship functions box shows information about own ship, enables offset and TM reset.

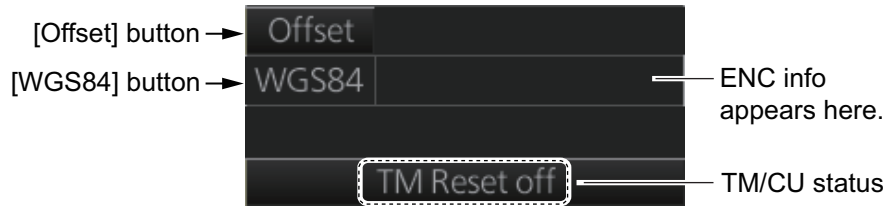

- **[Offset]** button: See section 16.8.1.
- **[WGS 84]** button: Convert position data between datum; go to selected position on the current chart. Click the button to display the dialog box shown in the right figure. To convert a position from one datum to another, select the datum source at the [Source] pull-down list and enter position. Select the datum to convert to at the [Converted] pull-down list then click the button. The position on the chart selected is shown below the [Converted] pull-down list. To go to a position, click a [Go To] button.

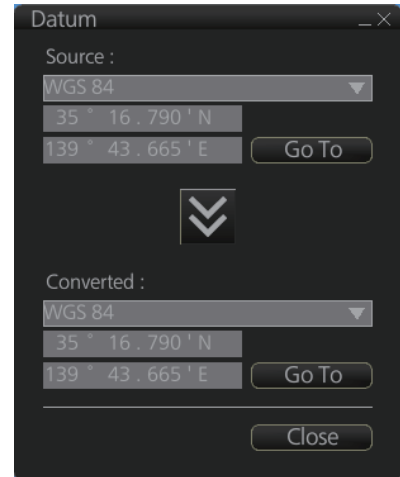

- **ENC info:** ENC chart info appears here.
 No indication: ENC chart is currently displayed.
 "Non-ENC data": Non-official ENC material, in yellow characters. See section 7.18.
- **TM/CU status:**
 "TM/CU Reset": True motion reset is active. (Chart is stationary and own ship moves on the chart.)
 "TM Reset off": When dragging the chart; true motion is OFF. To restart true motion, click the indication.
 "Ship off screen": Ship is out of the display area.

6.1.6 Route information box

Asterisks appear in data locations when no route is selected for navigation.

- [Route]: Name of monitored route.
- [Plan Speed]: Planned speed to approach "To WPT".
- [Plan Course]: Planned course between previous WPT and "To WPT".
- [Course to Steer]: Calculated set course to follow the monitored route, including XTD, drift and gyro error compensation.
- [XTD Limit]: Planned width of channel to approach "To WPT".
- [XTD]: Perpendicular distance the ship is from the intended track. The XTD figure can be shown in meters or nautical miles. Click this box, then select [XTD] and unit desired, or open the menu and select desired unit with [unit of "XTD"] in the [Route Information] menu.
- [To WPT]: The waypoint that the ship is approaching.
- [DIST to WOP] (Wheel Over Point): Distance to the point where rudder order for course change at "To WPT" is given.
- [Time to Go]: Time to go to WOP (hh:mm:ss).
- [Turn RAD]: Planned turning radius at "To WPT".
- [ROT]: Calculated rate of turn that is based on current speed and planned turning radius.
- [Next WPT]: The WPT following the "To WPT".
- [Next Course]: Next course (in degrees).

Route Information	
Route :	cc_import_03
Plan Speed :	20.0 kn
Plan Course :	337.5 °
Course to Steer :	332.9 °
XTD Limit :	185.0 m
XTD :	0.9 m
To WPT :	36
DIST to WOP:	0.50 NM
Time to Go :	00:05:38
Turn RAD :	0.50 NM
ROT :	000.0 °/min
Next WPT :	37
Next Course :	112.1 °

Course to steer

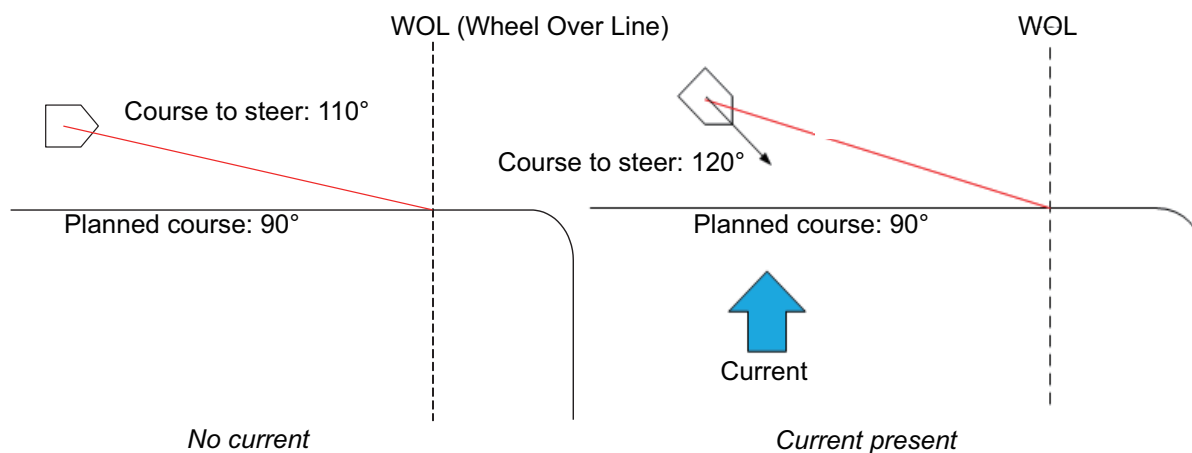

6.1.7 Overlay/NAV Tools box

The [Overlay/NAV Tools] box sets up the following objects and consists of the following pages.

- TT•AIS
- Echo*¹
- Parallel index lines
- Range rings
- Predictor (predicts ship's future movements)
- Under the keel clearance graphic
- Anchor watch
- Look-ahead*²
- Curved EBL*³

See chapter 15 for information about objects other than TT•AIS.

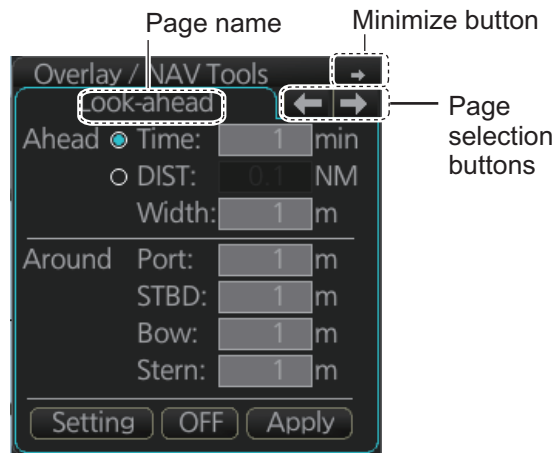

*¹: Available only when the Echo page is enabled at installation. Not available for B types.

*²: Always active when Back-up ECDIS mode is enabled.

*³: Available only when a EC-3000 with TCS functionality (optional specification) is connected to the same network.

6.1.8 Alert box

The [Alert] box shows operational and system alert messages, with alert ID no. and alert message. See chapter 20.



6.1.9 Permanent warning box

The permanent warning box displays chart-related warning messages. Click the arrow to show details. Click the arrow again to minimize the box.

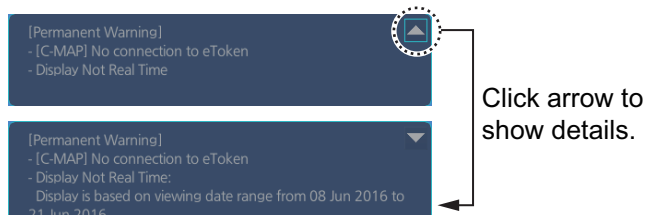

6.1.10 EBL, VRM boxes

The EBL measures the bearing to an object, and the VRM measures the range to an object. See section 6.10.

6.1.11 North mark

The north mark appears at the top left of the Chart for Radar display, is always visible, and points in the northerly direction. At high latitudes where north is not in a set direction, the north mark appears with the text "at own ship" or "at center" below the mark to show the reference point.



North mark

- "at own ship": Shown when your vessel is displayed on-screen. North is shown with your vessel as the reference point.
- "at center": Shown when your vessel is not displayed on-screen. North is shown with the center of the screen as the reference point.

6.1.12 Context-sensitive menus

Context-sensitive menus are available at the locations shown below. Right-click the applicable area then select the appropriate item from the menu. The availability of the context-sensitive menu depends on the mode in use, as shown in the table below.

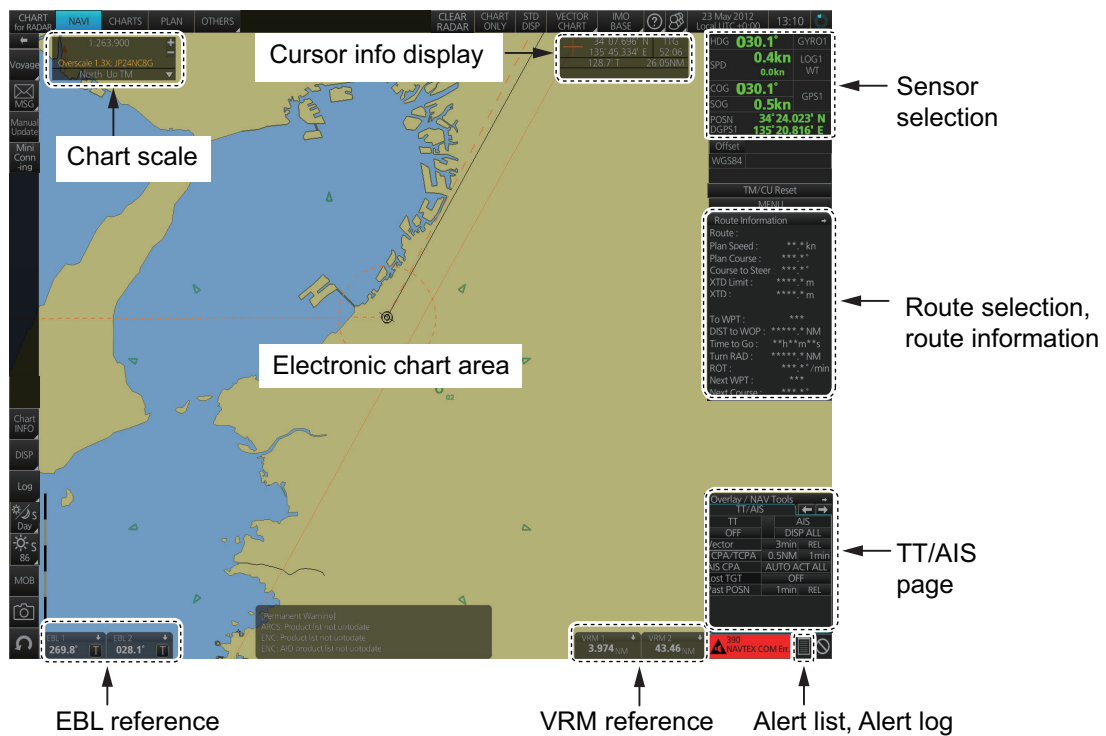

Item	Functions	Mode and availability		
		NAVI	CHARTS	PLAN
Chart scale	Drop-down list of chart scales.	Yes	Yes	Yes
Cursor info display	Switch cursor displays.	Yes	Yes	Yes
Sensor selection	Select sensors.	Yes	Yes	Yes
Route selection, route information	Select /unselect route for monitoring*; Move to plan*; Select user chart for monitoring*; Monitor INFO box*; Stop route monitoring*; XTD	Yes	Yes (XTD only)	Yes (XTD only)
TT, AIS page	Access TT, AIS functions.	Yes	Yes	Yes
Alert list, Alert log	Open alert list, alert log.	Yes	Yes	Yes
VRM reference	Select VRM reference; offset (heading or north).	Yes	Yes	Yes

Item	Functions	Mode and availability		
		NAVI	CHARTS	PLAN
EBL reference	Select EBL reference; offset (heading or north).	Yes	Yes	Yes
Electronic chart area	Own ship mark (or cursor position*) to screen center; object info; chart legend; manual update*; divider, hide MOB, [Message] dialog box.	Yes	No	Yes*

* NAVI mode only

6.1.13 How to enter alphanumeric data

On some screens it is necessary to enter alphanumeric data. The data can be input two ways: software keyboard or trackball.

Alphanumeric data entry from the software keyboard

A software keyboard is also available for entry of alphanumeric data. Do as follows to use the software keyboard. Display the keyboard before opening menus.

1. On the InstantAccess bar™, press the [DISP], [Keyboard] and [ON] buttons to show the software keyboard. The [BS], [Enter], [↑], [↓], [←], [→] and [Space] on the keyboard function the same as those keys on the keyboard of the Control Unit.



2. To switch between the alphabet keyboard and symbols keyboard, click the [!\$&] key.



Alphabet keyboard



Symbols keyboard

3. Click the input box.
4. Click appropriate keys and finally click the [Enter] key.

To erase the software keyboard, click the X button at the top right corner of the keyboard.

Alphanumeric data entry with the trackball module

The trackball module can also be used to enter alphanumeric data.

1. Put the cursor in the input box. Up and down arrows appear at the right side of the box.
2. Enter data by one of the methods shown below.
 - Spin the scrollwheel to set data. Upward to decrease the value; downward to increase the value.
 - Click ▲ to increase the value; ▼ to decrease the value.



How to enter latitude and longitude data with the trackball module

The trackball module can also be used to enter latitude and longitude data.

1. Put the cursor in the input box. A selection cursor (light-blue) appears.
2. Enter data by spinning the scrollwheel. Upward to decrease the value; downward to increase the value.
3. To switch coordinate between N and S and vice versa, put the cursor at the right edge of the input box. Dual arrows appear
4. Click to switch the coordinates. The method to switch E to W and vice versa is the same.

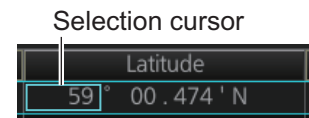

6.2 How to Select a Display Mode

Click the display mode button at the far left side of the Status bar then click [RADAR], [CHART for RADAR] or [CONNING for RADAR]* to select a display mode.

*Optional specification.

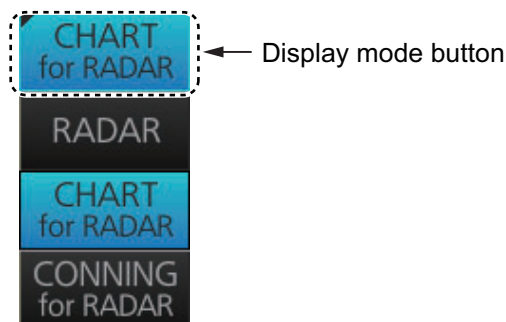

6.3 How to Select the Chart Operating Mode

The chart display has three chart operating modes: Voyage navigation, Chart maintenance and Voyage planning. Select a mode from the Status bar with the [NAVI], [CHARTS] and [PLAN] buttons. The background of the button of the active mode is light-blue.

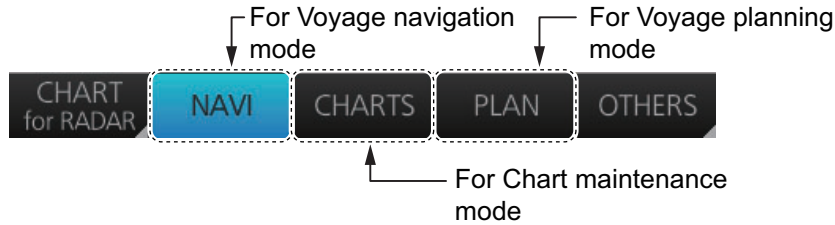

Note 1: When switching between the Voyage navigation and Chart maintenance modes it may take several minutes to read the chart when using C-Map charts or there are many charts installed.

Note 2: If the equipment accepts no key operation after switching to the Chart maintenance mode, reset the power.

6.4 How to Select the Chart Scale

When you open a chart it is displayed with the default scale, called the compilation scale. To change the chart scale, do one of the procedures shown below. The scale range is 1:1,000 to 1:70,000,000.

- Click the chart scale selection buttons in the Chart scale/presentation mode box.
- Right-click anywhere inside the Chart scale/presentation mode to show a drop-down list of chart scales.
- Put the cursor anywhere on the chart and spin the scrollwheel.

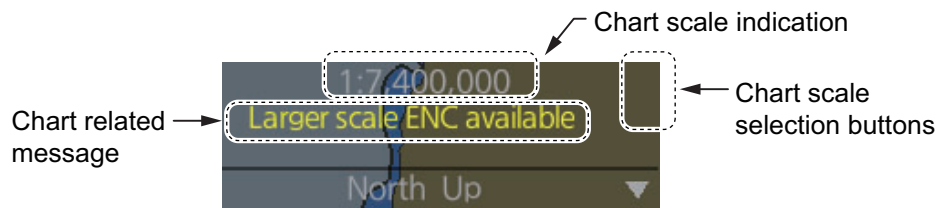

The table below lists the chart related messages and their meanings.

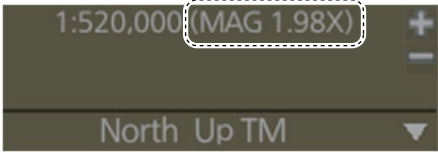
Message	Meaning
Display Not Real Time*	Displayed date is not the current date.
Non-ENC data	ENC non-compatible chart in use.
Larger scale ENC available	Larger scale available at current position (TM reset ON) or cursor location (TM reset OFF).
MAG	Chart display magnification. In the example below the magnification is 1.98. Appears with monitor size 32 inch or higher. 

Message	Meaning
Overscale	Scale too large.
RM(OFF)	Relative motion turned off when the chart is scrolled or the trackball is operated.

*: Shown as "Display Not Real Time: display is based on viewing date range from (start of date range) to (end of date range)" when the permanent warning dialog is maximized.

6.5 How to Select the Presentation Mode

The presentation mode depends on the chart operating mode, as shown in the table below.

	Voyage navigation mode	Voyage planning mode
North up TM	Yes	Yes ^{*2}
North up RM	Yes	No
Course up TM	Yes	Yes ^{*2}
Course up RM	Yes	No
Route up TM ^{*1}	No	Yes ^{*2}
Route up RM ^{*1}	Yes	No
Head up RM	Yes	No

^{*1}When monitoring a route.

^{*2}Motion mode (TM) is not shown. For example, "North up".

To select a presentation mode, click the presentation mode indication to cycle through the presentation mode choices or click the triangle to show the drop-down list of presentation modes.

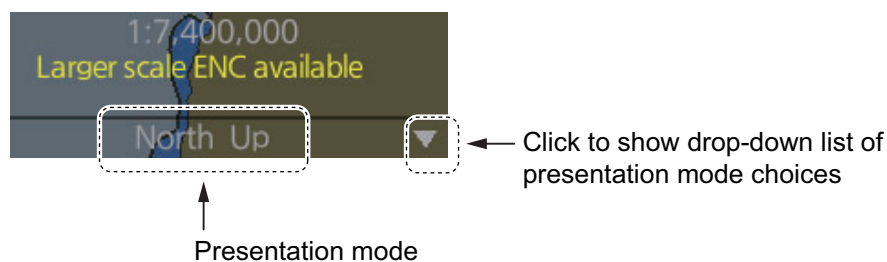

Presentation modes

North up: North (0 degrees) is at the top of the display.

Course up: The course is put at the top of the screen the moment it is selected.

Route up: The planned course is put at the top of the screen, in route monitoring. When route monitoring is canceled, the course up presentation mode is automatically selected.

Head-up: Heading is put at the top of the display.

TM (True Motion): Own ship mark follows ship's movement. The chart is fixed.

RM (Relative Motion): Own ship mark is put at the screen center and is fixed. The chart moves relative to own ship movement.

6.6 Cursor Position Box

The Cursor position box shows

- Cursor position in latitude and longitude
- Time to go to the cursor position
- The bearing (True or Relative) and range to the cursor position, or x-y coordinates of cursor position. Click the bearing and range indication or x-y coordinates indication to switch the indication, in the sequence shown below.

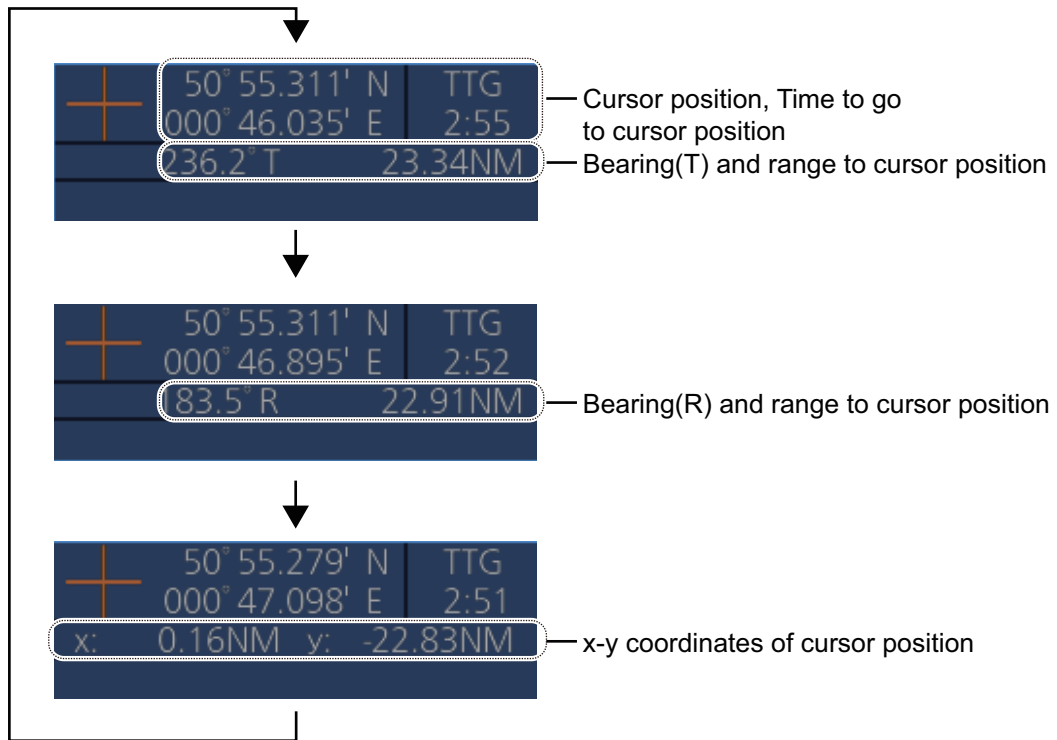

6.7 The Silent Mode

The silent mode, which requires a password to activate, deactivates the audio alarms from the chart system. Use this mode when the chart system is not required, like in a harbor. To go to the standby mode, first click the [OTHERS] button on the Status bar in the [CHART for RADAR] mode then click [SILENT]. Have the holder of the password enter the password then click the [OK] button.

To return to normal operation, click [Back to Normal Mode].

Note: The silent mode is automatically released when switching the operating mode (radar/chart radar/conning).

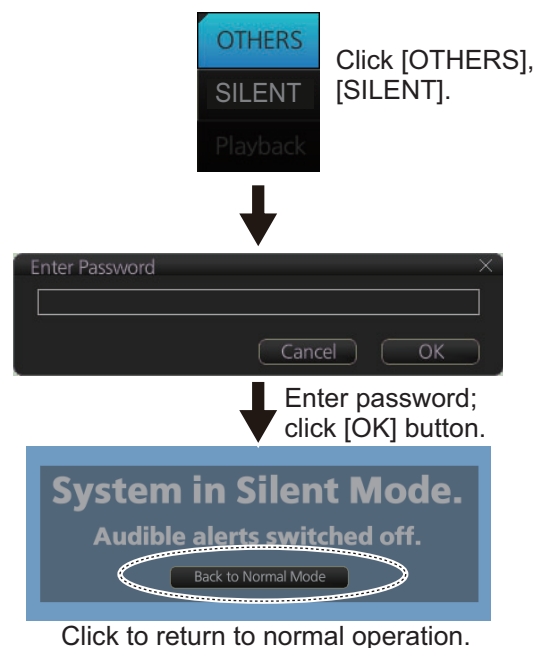

6.8 True Motion Reset

In the true motion mode, the chart is stationary and own ship moves on the screen. With TM reset active, own ship moves until it reaches the true motion reset borderline(s), then the chart is redrawn and own ship jumps back to an opposite position on screen based on its course. (This resetting can also be done manually by clicking the [TM/CU Reset] button.) When the TM reset function is active, "TM/CU Reset" appears at the right side of the display.

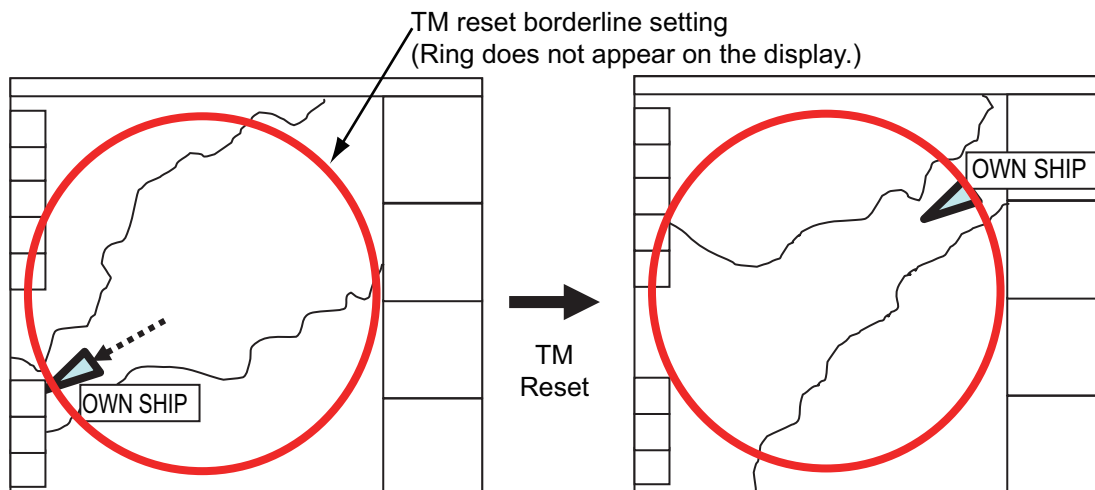

How to enable, disable automatic TM reset

To enable automatic TM reset, click the [TM Reset off] indication at the right side of the display to show [TM/CU Reset].



When the TM reset is disabled, change the chart scale with the scrollwheel and scroll the chart by drag and drop. The own ship functions box shows [TM Reset off]. When own ship moves off the screen the box shows [Ship off screen]. The TM reset is activated manually by clicking the [Ship off screen] button.

How to set the true motion reset borderline

You can set the limit for TM reset (in percentage) on the [Basic Setting] page. See section 8.2.2.

6.9 How to Control Route and User Charts in Voyage Navigation and Voyage Planning Modes

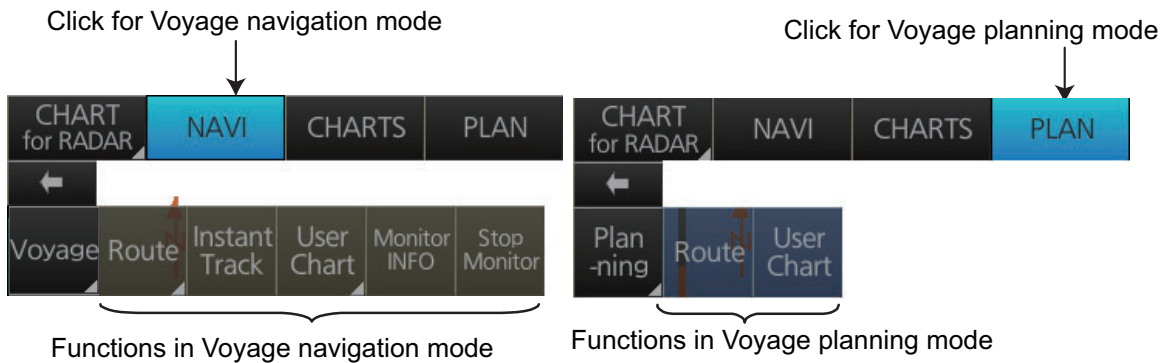

Click the appropriate chart mode button [NAVI] or [PLAN] at the top of the display to go to respective mode. For the Voyage navigation mode, click the [Voyage] button then click the button corresponding to the action to take. For the Voyage planning mode, click the [Planning] button followed by the [Voyage] button to select a route, or [User Chart] button to select a user chart.

Voyage navigation mode functions
<p>[Route]: This button has three functions:</p> <ul style="list-style-type: none"> • [Select]: Selects the route to monitor. • [Unselect]: Deselects monitored route. • [Move to Plan]: Moves monitored route to Voyage planning mode (for editing).
<p>[Instant Track]: Creates a temporary track to return to or make a temporary detour from the monitored course.</p>
<p>[User Chart]: This button has one function.</p> <ul style="list-style-type: none"> • [Select/Unselect]: Selects and unselects user charts from monitoring regardless of route being monitored.
<p>[Monitor INFO]: Opens the Monitor Information dialog box, to view monitored route, linked user chart and monitoring user chart information.</p>
<p>[Stop Monitor]: Stops monitoring a route and user charts.</p>
Voyage planning mode functions
<p>[Route]: Shows the [Route Plan] dialog box to create or edit a route.</p>
<p>[User Chart]: Shows the [User Chart] dialog box to create or edit a user chart.</p>

6.10 How to Use the VRM and EBL

The VRM measures the range to an object and the EBL measures the bearing to an object. There are two each of VRMs and EBLs. The lengths of the dashes on the EBL2 and VRM2 are longer than those of the EBL1 and VRM1 to distinguish them. The color of the VRMs and EBLs is orange.

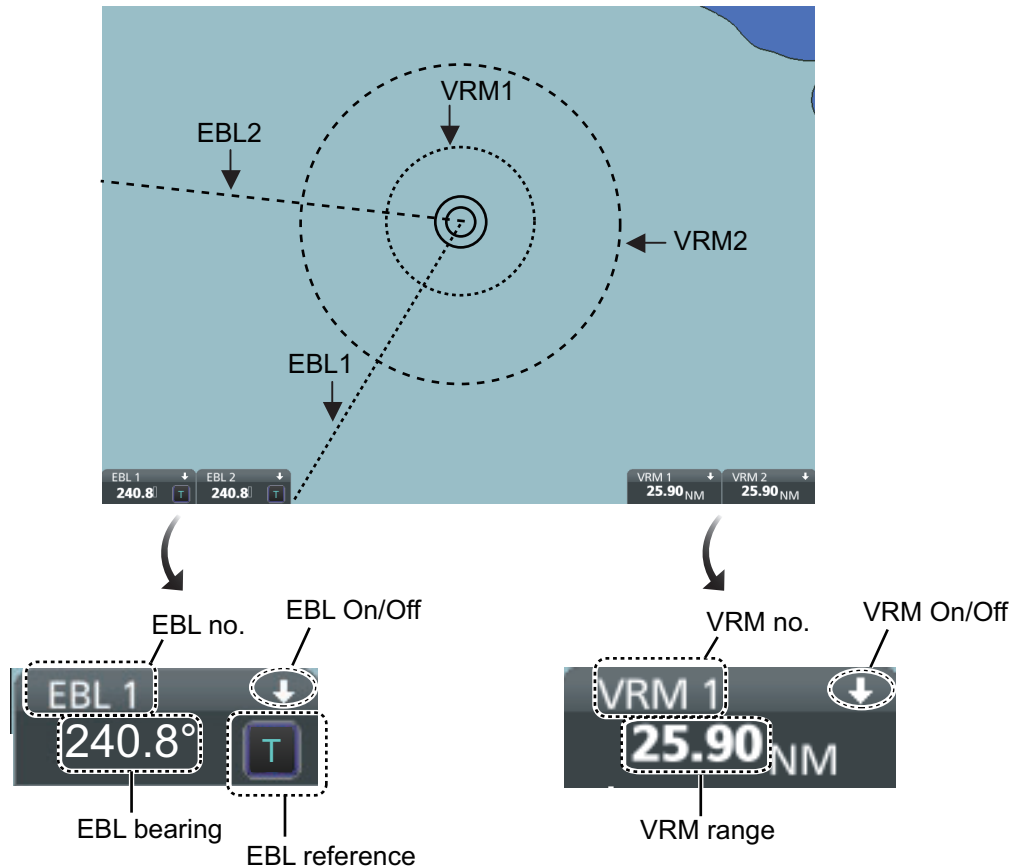

6.10.1 How to hide/show an EBL, VRM

Control Unit: Press the **EBL** or **VRM** key to hide or show respective marker.

Trackball module: Click the arrow on an EBL or VRM box to hide the respective marker. To redisplay the marker, click the minimized box.

6.10.2 How to measure the range and bearing

Range: Put the cursor on the VRM then drag the cursor until the VRM is on the inner edge of the object.

Bearing: Put the cursor on the EBL then drag the cursor until the EBL bisects the object.

6.10.3 How to select bearing reference

The EBL bearing reference can be true or relative. Click the EBL reference indication to display T (True) or R (Relative).

6.10.4 EBL, VRM functions available with the context-sensitive menu

The EBLs and VRMs have additional functions that are accessed from the context-sensitive menu. Right-click any VRM or EBL box to show the context-sensitive menu.

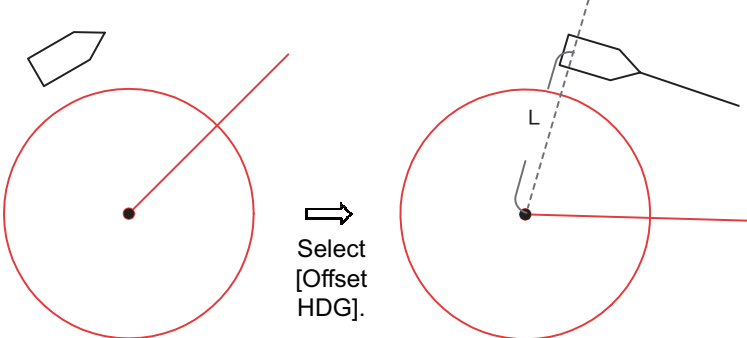
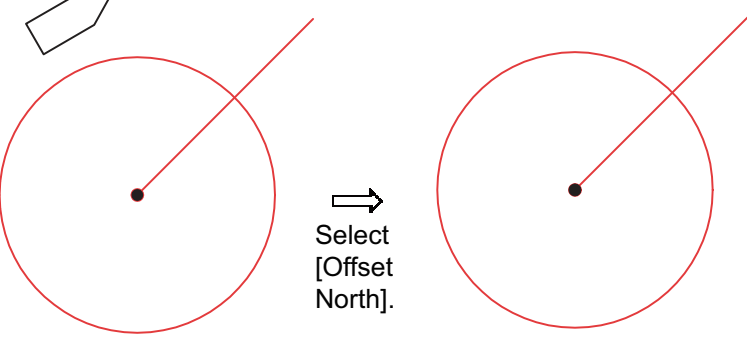

Function	Description
[Centered]	Centers the origin of the EBL and VRM on the current position.
[Ground]	Anchors the EBL and VRM to ground; neither the EBL or VRM move with ship's movement.
[Offset HDG]	 <p data-bbox="582 1198 869 1254">Drag and drop EBL, VRM on desired location.</p> <p data-bbox="925 1198 1348 1288">When vessel changes course, the EBL, VRM move so that the range (L) to their centers stays fixed.</p>
[Offset North]	 <p data-bbox="582 1691 869 1747">Drag and drop EBL, VRM on desired location.</p> <p data-bbox="925 1691 1348 1848">The EBL, VRM move to keep the angle from North to the center of the EBL, VRM, even if the vessel changes course. The distance to the center of the EBL, VRM is fixed.</p>

6.10.5 How to select the calculation method for EBL and VRM

The bearing for EBL and range for VRM can be calculated using either Rhumbline or Great Circle. To select the calculation method, do the following:

1. Open the menu then select [NAV Tools] and [Geometry]. The [Geometry] settings page appears.

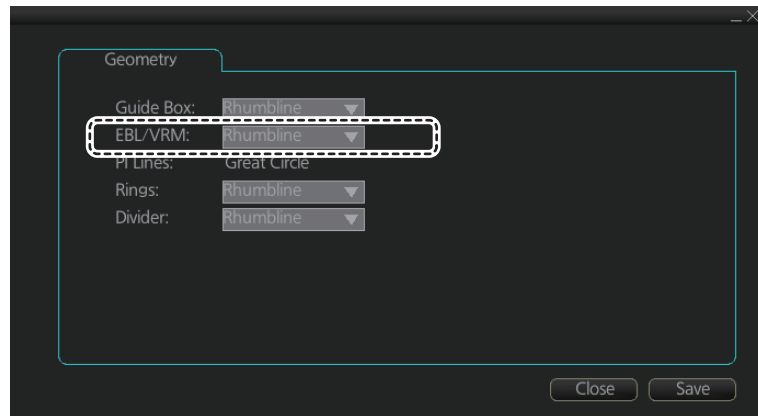

2. Click the triangle at [EBL/VRM] to show the drop-down options.
3. Select [Rhumbline] or [Great Circle] as appropriate.
4. Click [Save] to apply the changes, then click [Close] to close the menu.

6.11 Split Screen

You can split the screen in two, horizontally or vertically, in the [CHART for RADAR] mode, Voyage navigation display.

6.11.1 How to activate, deactivate the split screen

To activate the split screen or return to the full screen, click the [DISP] and [TWO DISP] buttons on the InstantAccess bar™ to show the choices for screen division. Click the screen division desired.

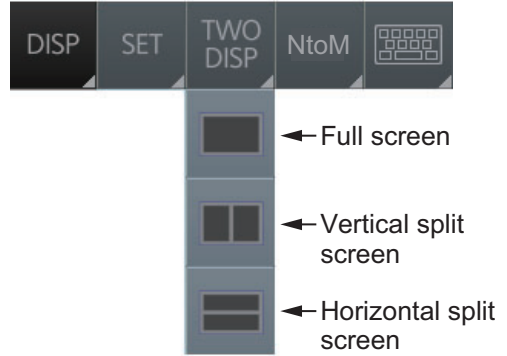

The example below shows the vertical split screen. The active display can be switched by clicking an [ACTIVE] button at the top of the display. The dividing line between the main and sub views cannot be moved.

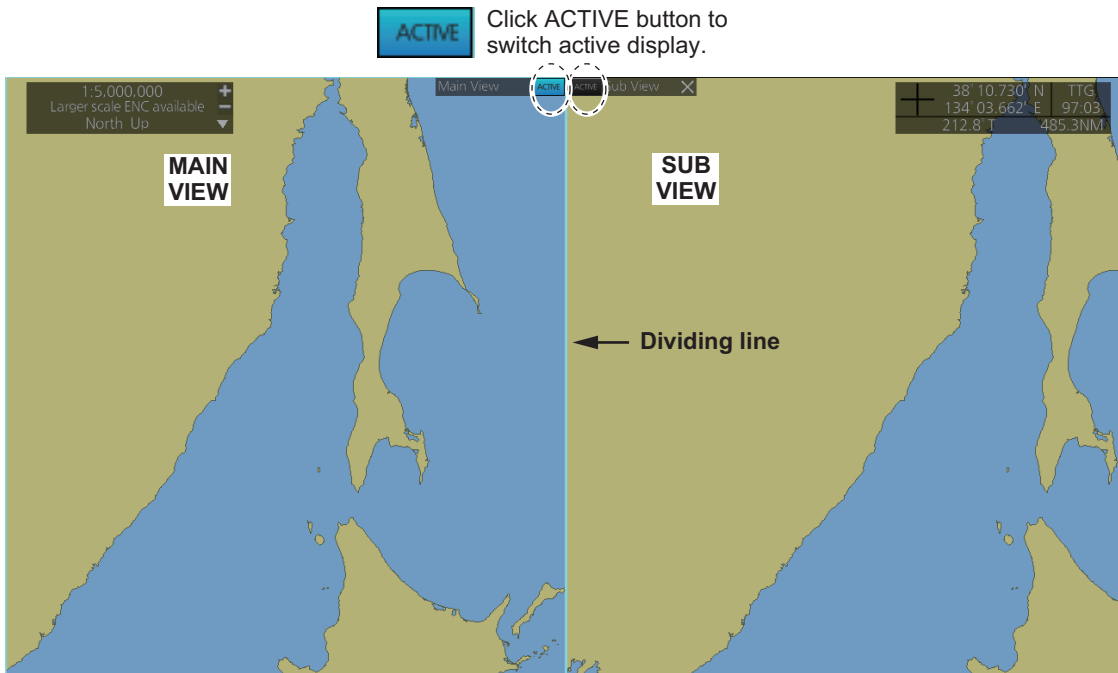

6.11.2 Function availability

Item (CHART for RADAR mode)	Viewable		Operable	
	Main	Sub	Main	Sub
AIS target	Yes	Yes	Yes	Yes
TT	Yes	Yes	Yes	Yes
EBL, VRM	Yes	Yes	Yes	Yes
Parallel index lines	Yes	Yes	Yes	Yes
Divider	Yes	Yes	Yes	No
Range rings	Yes	Yes	Yes	No
Anchor watch	Yes	Yes	Yes	No
Danger highlight	Yes	Yes	Yes	No
Chart display	Yes	Yes	Yes	No

6.11.3 Split screen usage characteristics

- If the sub view is not displayed correctly, restore the full screen display then try to activate the split screen again.
- The display may not be updated when switching to the Voyage planning mode. If this occurs, switch to the Voyage navigation mode, restore the split screen display then return to the Voyage planning mode.
- The own ship mark may not appear at the screen center when releasing the split screen display. If this occurs, click the indication "TM/CU Reset" at the top right position on the screen to show the own ship mark at the screen center.
- The TM reset feature only works on the active display. To return the own ship mark to the screen center, click the indication [TM/CU Reset] at the top right position on the screen.
- The sub view can use a location and chart scale different from the main view.
- The chart scale related messages (overscale, larger ENC available, etc.), which appear beneath the chart scale indication, show only on the main view.

6.12 Datum

6.12.1 General

Datum is a mathematical model of the earth based on which a sea chart is produced. If the datum of a position sensor and that of a sea chart are different, a transformation has to be made somewhere in the system. Not doing so can result in errors of several sea miles. The difference between two datum is never constant, but depends on position. This means that the difference between WGS-84 and local datum, generally used in paper charts, is not generally valid with electronic sea charts.

6.12.2 Paper charts

Datum used in paper charts have been traditionally national datum for historical reasons. Many paper charts do not have a marked datum, therefore compatibility with electronic charts may be complicated. In some paper charts, the correction terms are printed in lieu of datum, for correction of the WGS-84 system satellite locations. The correction terms are usable but only with the paper chart in question.

6.12.3 Electronic sea charts

The ENC vector material has to be produced by a National Hydrographic Office in the WGS-84 datum.

6.12.4 Positioning devices and datum

In early days of electronic positioning devices, datum received little attention because the commonly used systems utilized special charts (like Decca charts). Later on, data output was added to these systems, but still no attention was paid to datum and the position errors were considered as an inaccuracy of the system. With the spread of the GPS, however, datum has become better known. An accurate position is of no value if co-ordinates are in a wrong datum. GPS satellites utilize the WGS-84 datum.

6.12.5 Chart radar and datum

The chart radar uses ENC material, produced to standards using WGS-84 datum. Positioning devices connected to the chart radar must work in the WGS-84 datum. IMO requires that the chart must give an alert if the datum of a positioning device is not the WGS-84.

6.13 How to Select Sensor Settings

Sensor settings can also be selected in the chart for radar mode. Settings are mutually changed between the radar and chart for radar modes.

This chart radar system accepts navigation data input two ways: [System] or [Local]. [System] shares sensor data among multiple chart radars in network. Sensor priority is also commonly shared among the chart radar. [Local] selects a sensor outside the network.

1. Right-click anywhere in the Sensor information box to show the context-sensitive menu.
2. Click [Local] or [System].

Note: Sensor system can also be selected from the menu. Open the menu and click [System/Local Select] on the [Sensor] menu. Click the circle next to [System Sensor] or [Local Sensor] then click the [Save] button.

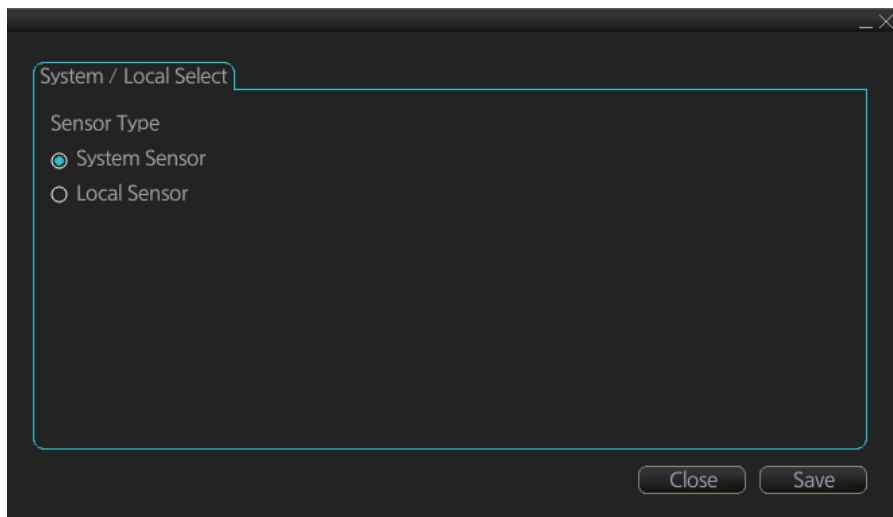
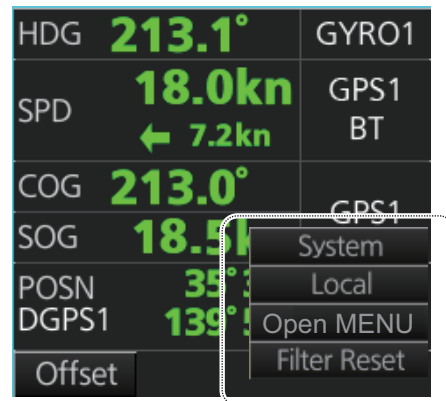

6.14 How to Enter Ship Speed

Speed can also be entered in the chart for radar mode. Settings are mutually changed between the radar and chart for radar modes.

The speed can be entered from a log (STW) or GPS (SOG), or manually on the menu.

1. Right-click anywhere in the Sensor information box to show the context-sensitive menu.
2. Click [Open MENU].
3. Click [System Sensor Settings] or [Local Sensor Settings].
4. Click the [SPD] tab.

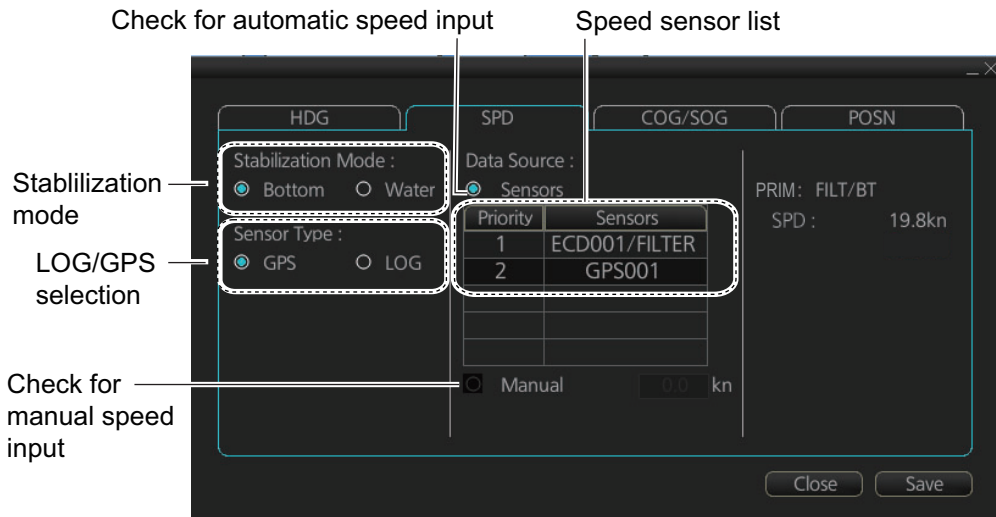
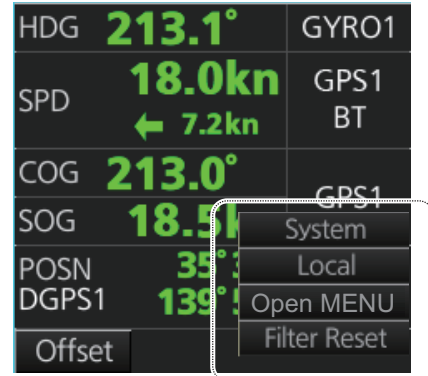

[SPD] page, system sensor

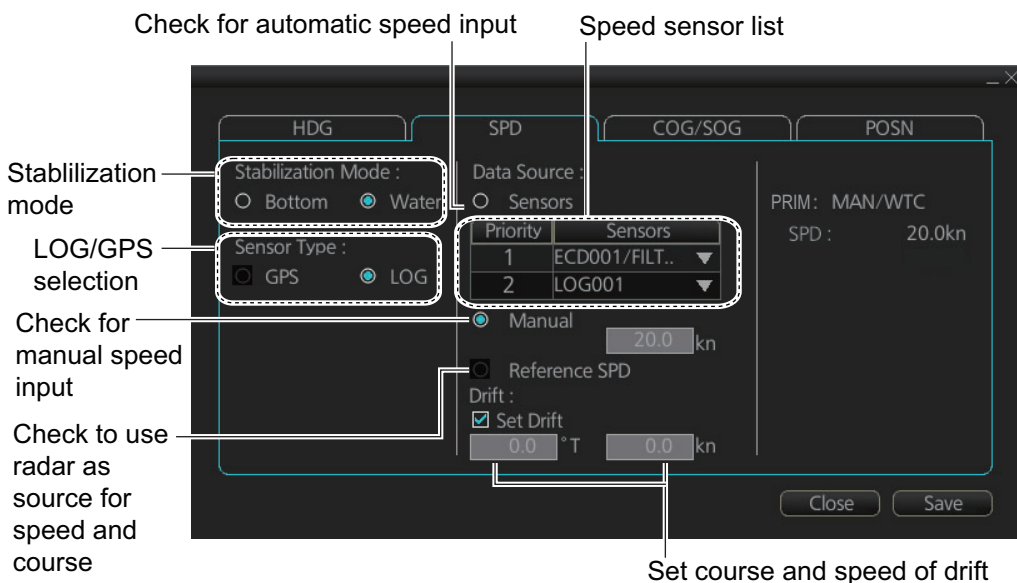

Set course and speed of drift

[SPD] page, local sensor

6. CHART OVERVIEW

5. **For automatic input**, follow the procedure below. **For manual input**, go to step 6.
 - 1) Check [Sensors].
 - 2) Set the priority for the speed sensors in case of Local sensor. Click the triangle on the Priority1 line to select the sensor to be the Priority1 sensor. Do the same for the Priority2. Only one sensor can be Priority1; all others are priority 2. If a speed sensor is changed from Priority2 to Priority1, then that sensor previously selected to Priority1 is then automatically selected to Priority2 state.
 - 3) Check [LOG] or [GPS] at [Sensor Type].
 - 4) Select [Bottom] or [Water] at [Stabilization Mode]. Select [Bottom] if GPS is the source of speed data, or [Water] if a speed log is the source of speed data.
 - 5) Go to step 7.
6. **For manual input**, set the stabilization mode for [Water] and check [Manual]. Enter the speed using the scrollwheel, the software keyboard or the keyboard on the Control Unit.

Note: For set and drift, see page 16-3.
7. Click the [Save] button to save settings then click the [Close] button to close the menu.

Notes on speed input

- Be sure not to select a LOG option when a speed log is not connected. If the log signal is lost, the GPS sensor is used. In the event of GPS loss, the SPD is shown as "***.* kn".
- The SPD is shown as "***.* kn", and the label "LOG" is erased if no log signal is present for a certain amount of time. The timeout varies according to ship.
- If communication with a sensor is lost or interrupted, the system changes to the next available sensor automatically. For example, if the sensor type is set to [LOG] and the speed log signal is interrupted or lost, the system can switch to a GPS sensor. In this case, the "LOG" indication appears in yellow color.
- A single-axis water log cannot measure speed when the wind is coming from the leeway direction.

6.15 How to Enter Heading

Heading can also be entered in the chart for radar mode. Settings are mutually changed between the radar and chart for radar modes.

Note: When the vessel is in high latitudes (over 85°), data from the gyrocompass is not used. The internal filter data is used for heading calculation. In this case, the heading source in the sensor information box appears as "FILT". However, high latitudes are not supported in RADAR mode.

Heading can be entered manually or automatically.

1. Right-click anywhere in the Sensor information box to show the context-sensitive menu.
2. Click [Open MENU].
3. Click [System Sensor Settings] or [Local Sensor Settings].
4. Click the [HDG] tab.

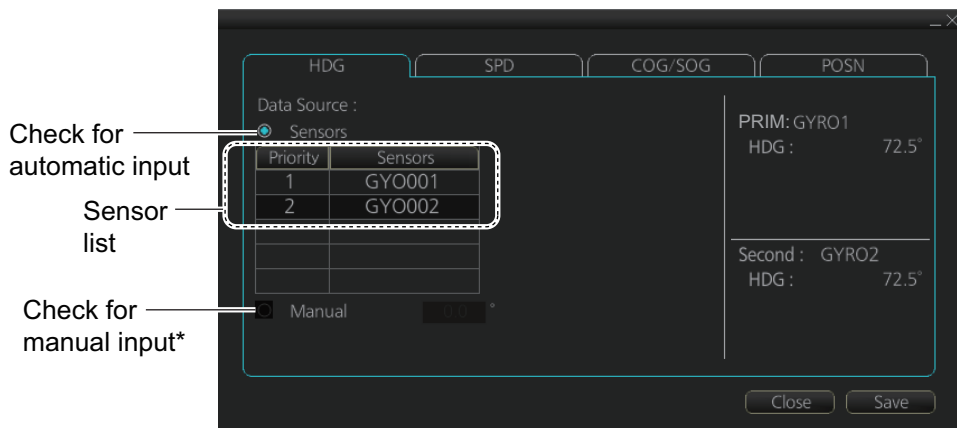
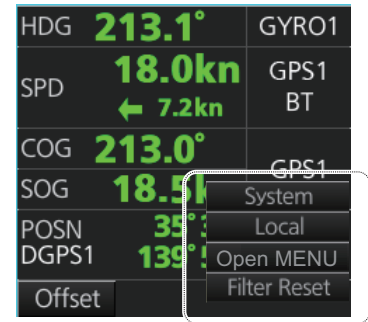

*: This is not available with the [System Sensor Settings] menu. This is not shown on IMO type.

[HDG] page, system sensor

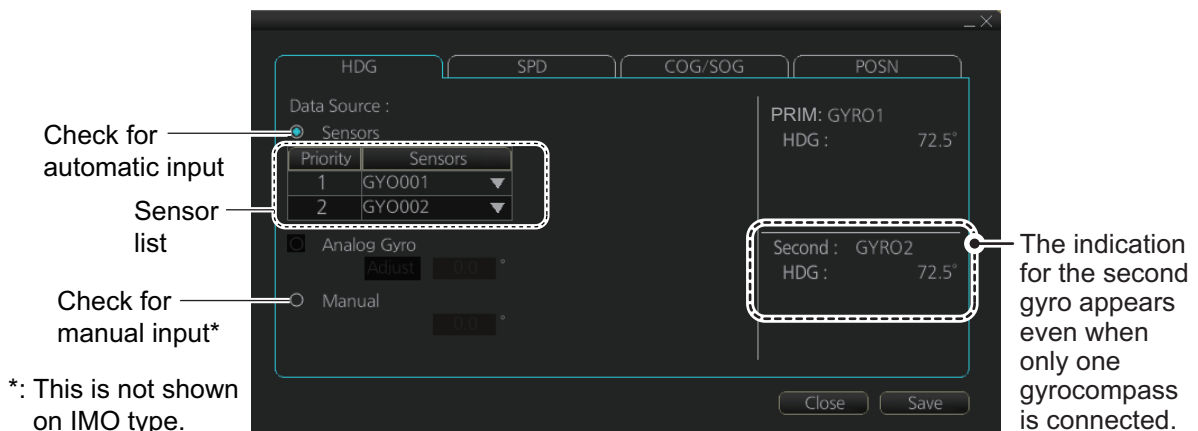

*: This is not shown on IMO type.

[HDG] page, local sensor

6. CHART OVERVIEW

5. **For automatic input**, follow the procedure below. **For manual input**, go to step 6.
 - 1) Check [Sensors].
 - 2) For local system settings, set the priority for each sensor connected, referring to section 6.14.
 - 3) Go to step 7.

Note: For the local sensor, an offset can be applied to the gyro reading if it is wrong. Check [Gyro Correction], then spin the scrollwheel to set the offset.
6. **For manual input**, check [Manual]. Enter the heading using the scrollwheel, the software keyboard or the keyboard on the Control Unit.
7. Click the [Save] button to save settings then click the [Close] button to close the menu.

6.16 Set up Before Departure

6.16.1 Updates before departure

Update S57 chart material

Update your S57 chart material before embarking on a new voyage. See section 7.19.

Display date and update review dates for S57 charts and manual updates

Note: It is very important that you set the Display and Update Review dates for charts as the current date.

There may be features that require chart viewing dates or seasonal dates in charts. Accordingly, if you have not set Display date and Update Review dates as the current date, there is a possibility that you can get a wrong presentation or some feature may be absent. See section 9.2.

Create or update user chart. Notes

If necessary, create a new user chart and Notes or modify existing ones. See chapter 13.

Chart alert calculation

Set chart alert areas suitable for your coming voyage, on the [Look-ahead] page in the [Overlay/NAV Tools] box. See section 11.2.

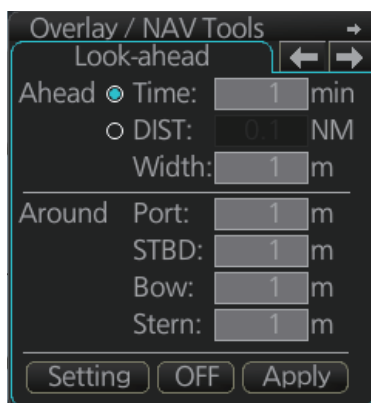

6.16.2 Create or update a route

Create a new route or modify an existing one. See chapter 12.

Check your route against chart alerts

Before you sail your route, you should always check your route against chart alerts. This is important because your S57 charts and manual updates may contain chart viewing dates information. You can check chart alerts from the [Check Results] page on the [Route Plan] dialog box.

The following information is stored with the monitoring route plan:

- Conditions for chart alerts during route monitoring, which includes safety contour and other chart alerts, on the [Alert Parameters] page of the [Route Plan] dialog box.

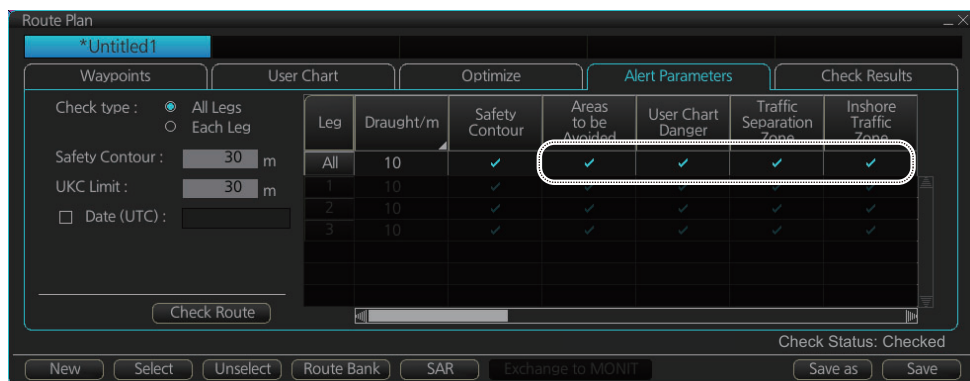

- Name of the user chart to be used during route monitoring together with this planned route, on the [User Chart] page of the [Route Plan] dialog box.

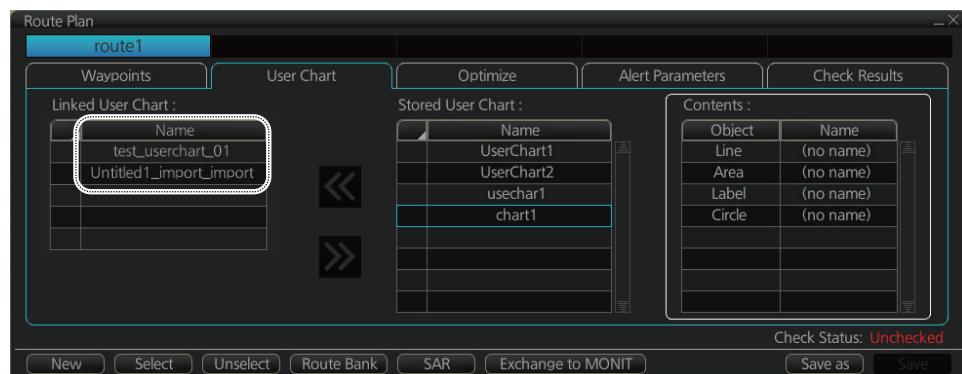

- Name of the Notes to be used during route monitoring together with this planned route, on the [User Chart] dialog box (click the [Planning] button then click the [User Chart] button).

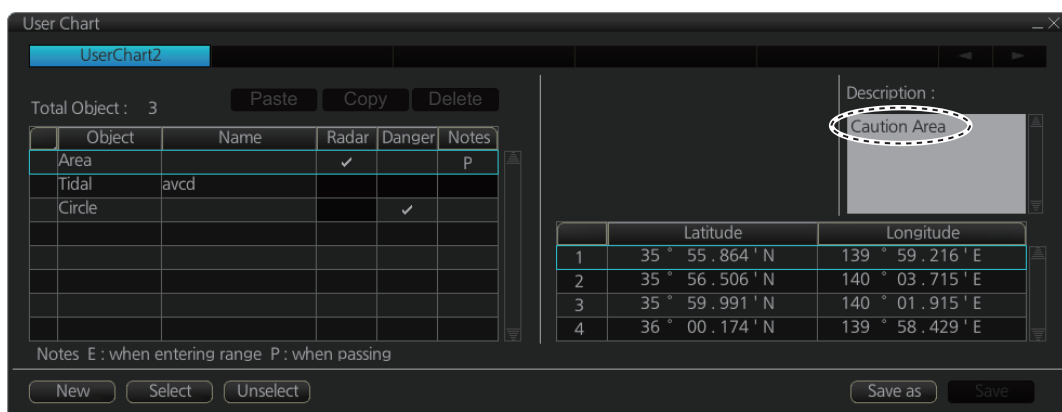

Recalculate timetable and ETA values

Timetable and ETA values can be recalculated from the [Optimize] page in the [Route Plan] dialog box. Minimally set ETD to equal departure time, and set optimization values.

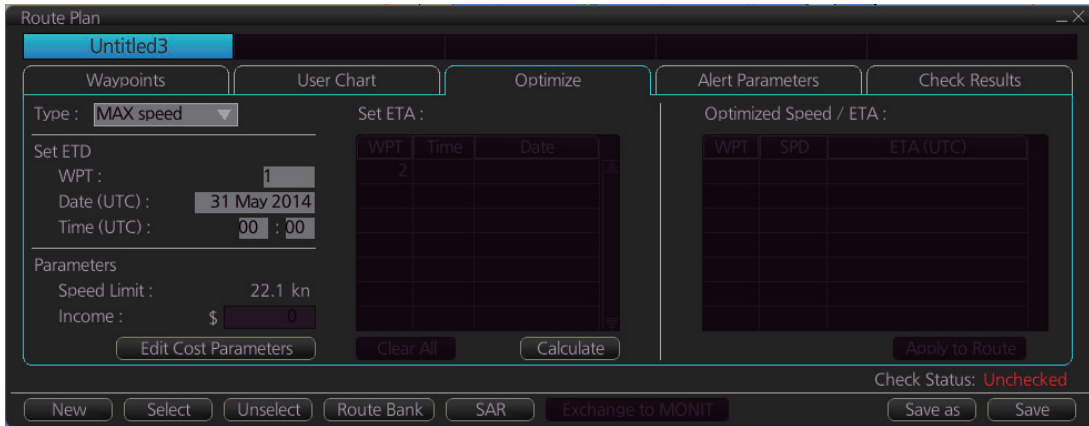

6.16.3 How to check and prepare the route, user chart to monitor

Select the route to monitor, view linked user charts

Select a route for the voyage: In the Voyage navigation mode, click the [Voyage], [Route] and [Select] buttons, or right-click the route indication in the [Route Information] box (right edge of screen) then select [Select Route]. See chapter 14.

The [Monitor Information] dialog box appears, showing the [Waypoints] tab.

Note: A route cannot be opened if its planned settings are different from its navigation settings. The reason is given on the [Select Route] dialog box. In this case, open the route in the Voyage planning mode and click the [Check Route] button, on the [Alert Parameters] page. Adjust the route as necessary.

The To WPT can be selected, however WPT 01 cannot be selected.

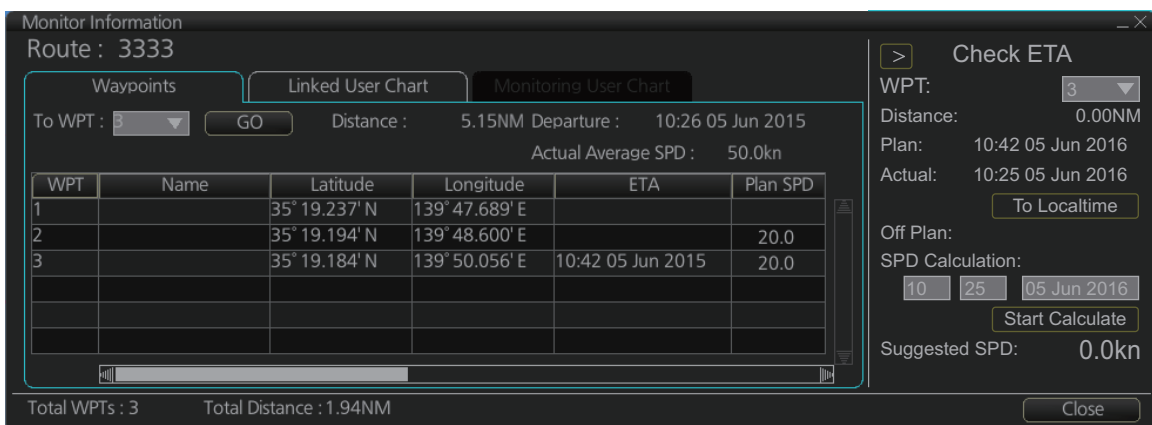

To see all the user charts linked to the route, click the [Linked User Chart] tab to show the names of all the user charts linked to the route. Click a user chart to view its contents.

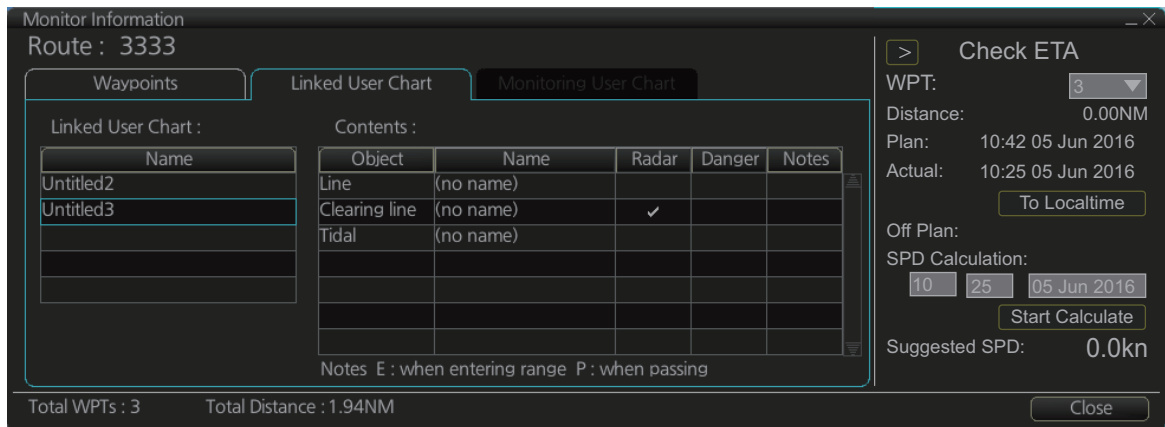

Select confirm conditions of the route plan

Check the setting on the [Chart Alert] dialog box; click the [DISP], [SET] and [Chart Alert] buttons to show that dialog box.



Select the user chart(s) to monitor

A user chart can be monitored without linking it to a route. You can select a user chart two ways.

- Click the [Voyage], [User Chart] and [Select/Unselect] buttons on the InstantAccess bar™ to open the [Select Monitor User Chart] dialog box.
- In the Voyage navigation mode, right click anywhere in the Route information box (right side of screen) to show the [Select Monitor User Chart] dialog box.

Check the chart(s) to use in the [Stored User Chart] window, then click the [<<] and [Open] buttons.

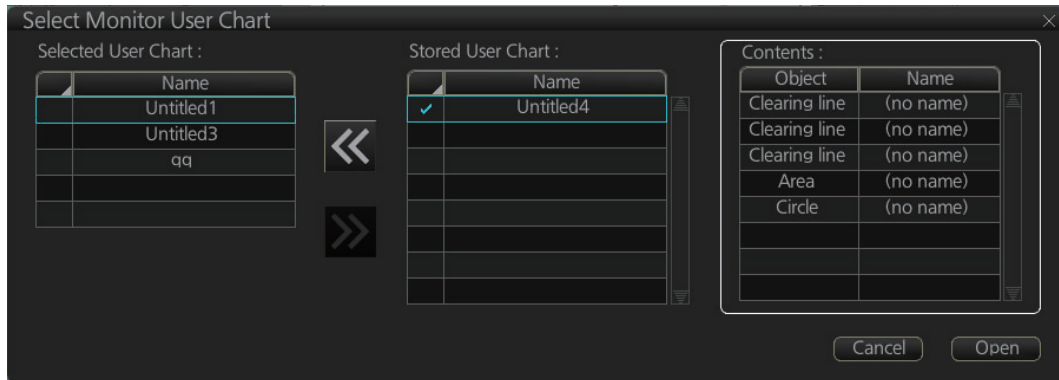

The [Monitor Information] dialog box automatically appears and the user chart(s) selected are displayed in the [Monitoring User Chart] tab. Click a user chart to view its contents.

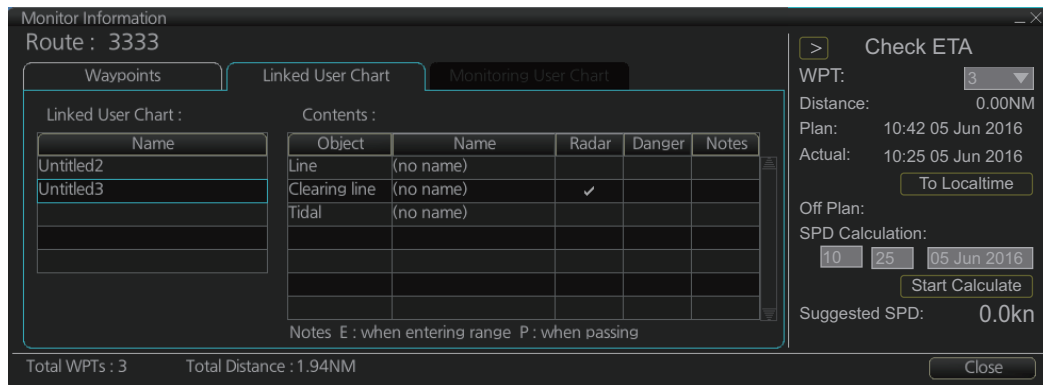

6.16.4 Check configuration of navigation sensors

You can check the configuration of your navigation sensors.

Check speed settings ([SPD] page)

Open the menu and click the [SPD] tab in the [System Sensor Settings] page or [Local Sensor Settings] page of the [Sensor] menu. The user can select navigation sensors for use in navigation and view their current values.

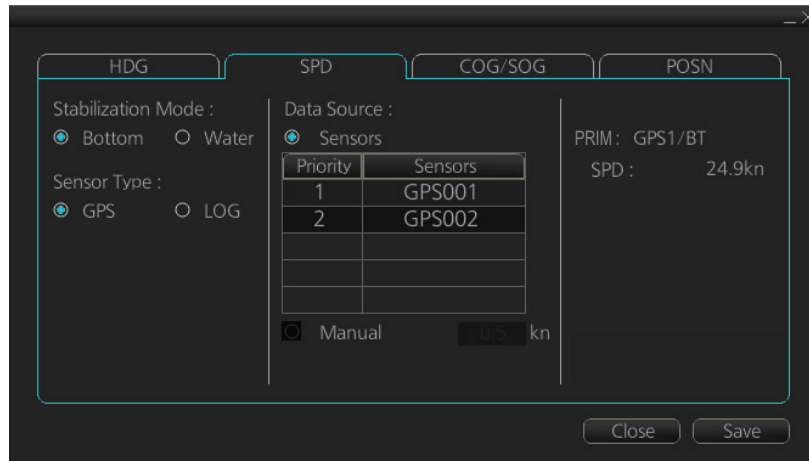

[SPD] page, system sensor

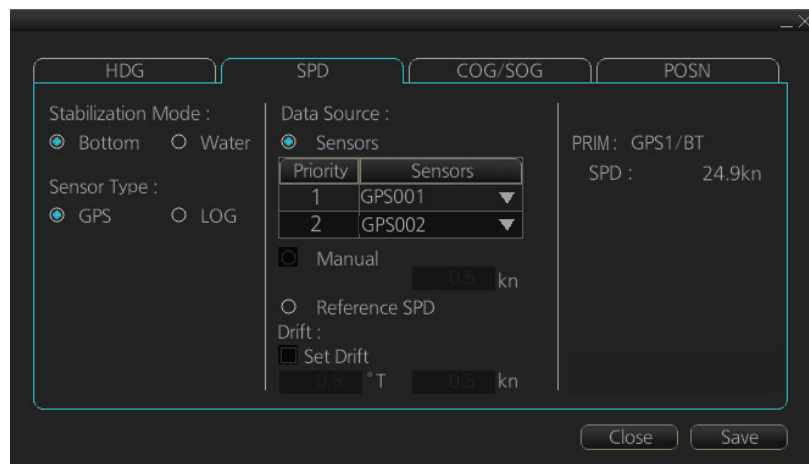

[SPD] page, local sensor

Checkbox status shows whether the sensor is used for integrated navigation or not. If there is no value shown for a sensor, it indicates that the sensor is not valid. Note that the content of these pages depends on the sensors that are in use on the ship.

Select the available dual logs.

Note that manual speed should only be used in an emergency, when no other speed reference is available. Remember that position sensors are also available as speed sources. If no dual log is available, check [Reference SPD] (local sensor page) to use a reference target from the radar as the source for speed and course.

Check position sensors ([POSN] page)

Open the menu and click the [POSN] tab in the [System Sensor Settings] page or [Local Sensor Settings] page of the [Sensor] menu. The [PRIM] and [Second] labels indicate the type of the position sensor. (In the figure below the [PRIM] label shows GPS1.) [PRIM] and [Second] indicate sensor status and priority.

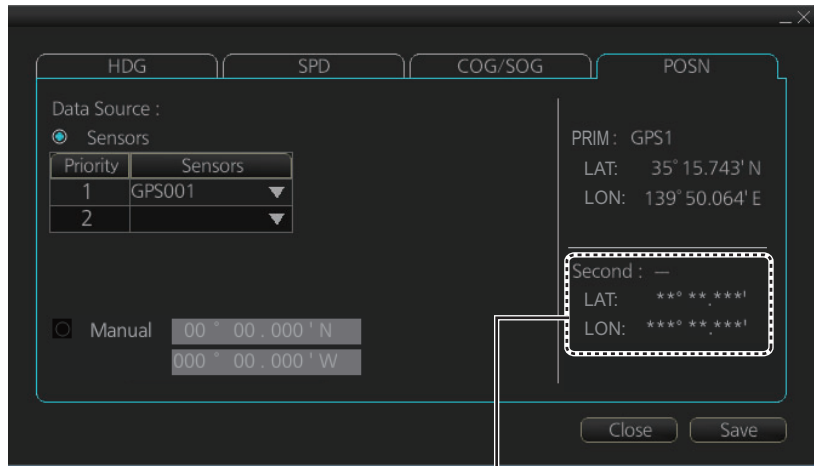

“Second” appears even when only one position-fixing equipment is connected.

Only one sensor can be primary while the others can be secondary or off position. After a sensor is turned off, its status is changed to [Second] (Secondary) state. When a position sensor state is changed to [PRIM] (Primary) and another sensor was [PRIM] (Primary), the sensor formerly [PRIM] (Primary) becomes [Second] (Secondary).

Select the "Primary" navigation sensor as the sensor that is considered to be most accurate and reliable. Set all other navigation sensors as "Secondary".

6.16.5 How to reset odometer and trip meter

To reset the odometer and/or trip meter do as follows:

1. Open the menu and select the [Voyage] menu from the [NAV Log] menu in the [Log] menu.

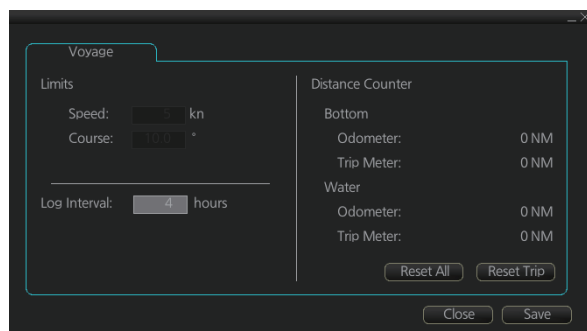

2. Click one of the following buttons.
 - [Reset All]: Reset both the odometer and the trip meter for both "Water" and "Bottom".
 - [Reset Trip]: Reset the trip distance for both "Water" and "Bottom".
3. Click the [Close] button to finish.

7. HOW TO MANAGE CHARTS

This chapter mainly shows you how to install the public keys, licenses and charts, manually update chart objects, and synchronize charts. All chart-related operations begin from the Chart maintenance mode, which you access by clicking the [CHARTS] button on the Status bar.

Note 1: Charts, routes and user charts are shared with other FMD-3xx0, FCR-2xx9 and FAR-3xx0 units, via LAN. Data is shared automatically; no operation is required.

Note 2: Chart processing (installation, deletion, etc.) may take several minutes depending on the number of charts to be processed.

Note 3: If, when attempting to install charts, nothing appears on the display at the start of the procedure, reset the power and try again.

Note 4: If installation of AVCS charts stops, the message "Chart installation has stopped. Run the installation again. Installation will continue from the chart not yet installed." appears. This does not indicate completion of the installation. Restart the installation. The installation resumes from the chart not yet installed.

This message may also appear when installing C-MAP ENC SERVICE, C-MAP PROFESSIONAL+ C-MAP ENC+ SERVICE charts if the user does not confirm completion of the installation within approx. one hour. (Installation window remains on the screen.) However, this is not an indication of failed installation.

Note 5: When installing the AVCS LargeMedia, the message "No connection to dongle" may appear in the [Result] window at the completion of the installation. If this occurs, reinstall the media.

7.1 How to Install Public Keys for ENC Charts

Public keys authenticate the source and integrity of the ENC chart materials used in this chart system. Before you install a new ENC chart, confirm that the corresponding public key is installed.

Generally, there are two types of public keys: IHO (file name: IHO.PUB), Primar (file name: PRIMAR.pub)

1. Set the medium (DVD, USB flash memory, etc.) that contains the public key. (The IHO public key is preinstalled.)
2. Get into the Chart maintenance mode then click the [Public Key] button on the InstantAccess bar™.

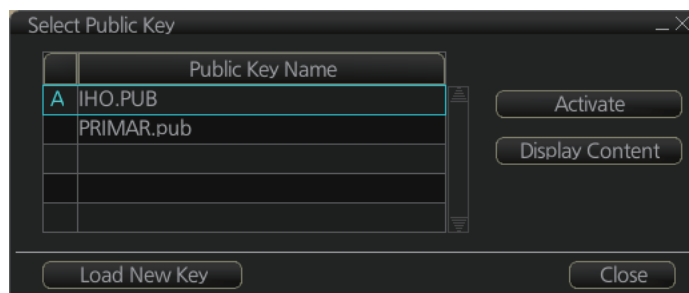

3. Click the [Load New Key] button to show the [Open file] dialog box.
4. Find the .pub file then click the [Open] button. The [Select Public Key] dialog box reappears.

7. HOW TO MANAGE CHARTS

- Click the [Display Content] button on the [Select Public Key] dialog box to show the display contents.

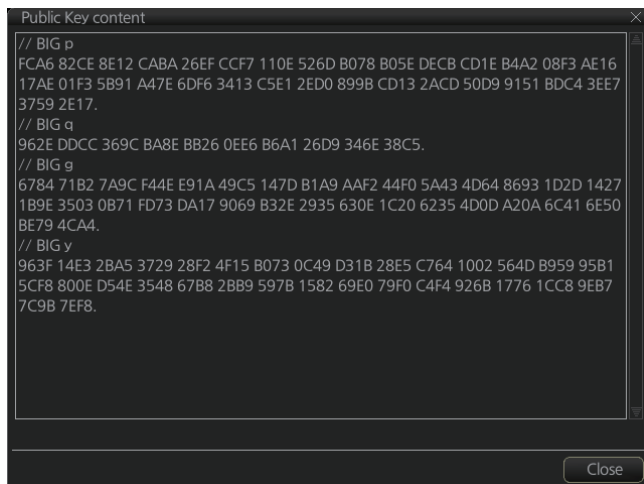

- To accept the contents, click the [Activate] button on the [Select Public Key] dialog box.

7.2 How to Install ENC Licenses, Charts

Install your ENC licenses and charts, in that order.

7.2.1 How to install an ENC license

Automatic installation

- Insert the medium (DVD, USB flash memory, etc.) that contains the ENC license.
- Get into the Chart maintenance mode then click the [License] button on the InstantAccess bar™ to show the [Licenses] dialog box.
- Click the [Import Licenses] button.

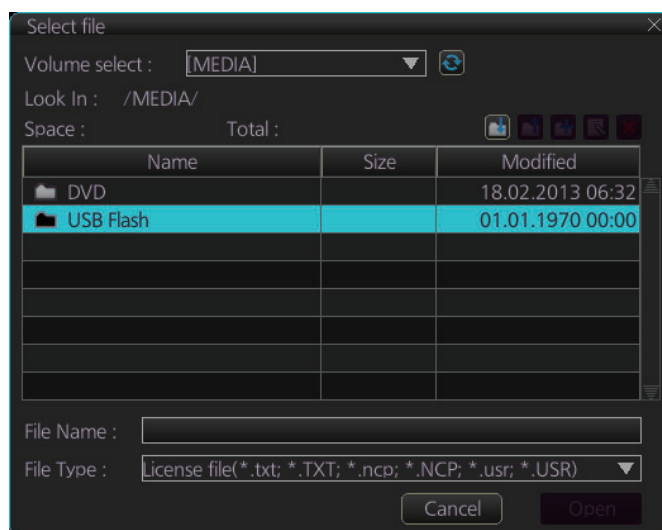

- Select the medium, or folder, that contains the license then click the [Open] button.

- Find the license (permit.txt) then click the [OK] button to install the license. The [Licenses] dialog box then shows cell name, date of expiration, data server name and subscription type of the license.

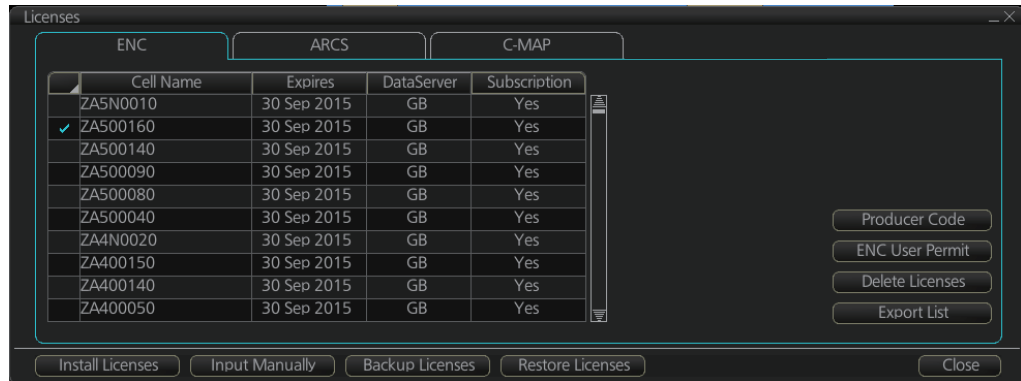

- Click the [Close] button to finish.

Manual installation

If you do not have the medium which has your ENC license, you can enter the license number manually.

- Click the [CHARTS] button on the Status bar to go the Chart maintenance mode, then click the [License] button on the InstantAccess bar™.
- Click the [Input Manually] button to show the [Input License Manually] box.

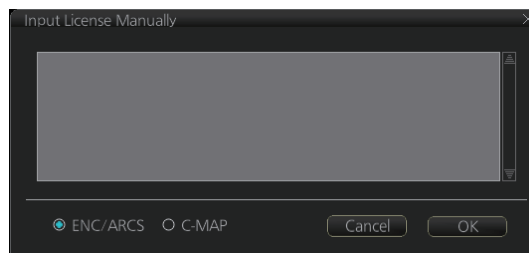

- Select the type [ENC/ARCS] at the bottom of the screen.
- Enter the license number(s) then click the [OK] button.

7.2.2 How to install ENC charts

When you install charts from a medium, the system first loads a catalog, which stores certain information into your SSD such as cell IDs, their position, and edition number, from the install medium. Then, the system asks which charts you want to install from the chosen medium. After building the catalog, you can view the contents of it by clicking the [Cell Status] button on the InstantAccess bar™.

Note 1: Do not click the [Cancel] button during the installation of a chart. If you get an error message, try to install the charts again.

Note 2: When any chart is installed, all checked routes are reverted to unchecked status. Use the [Check Route] button on the [Alert Parameters] page to re-check routes before starting any voyage.

- Set the medium that contains the ENC charts.
- Get into the Chart maintenance mode then click the [AUTO Load] button on the InstantAccess bar™. The confirmation message "Attention: This process takes time to complete, and the operation speed of the system will decline. Do you wish

7. HOW TO MANAGE CHARTS

to continue?" appears. Click the [OK] button to continue. A message informs you that the system is searching the medium (in the figure below the medium is a DVD) for chart data.

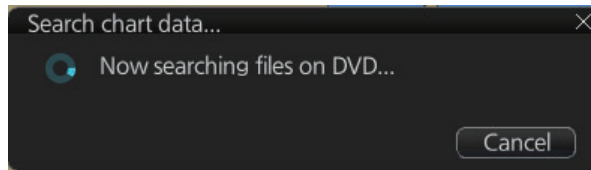

The results of the search are displayed, an example of which is shown below. To cancel the installation, click the [Cancel] button.

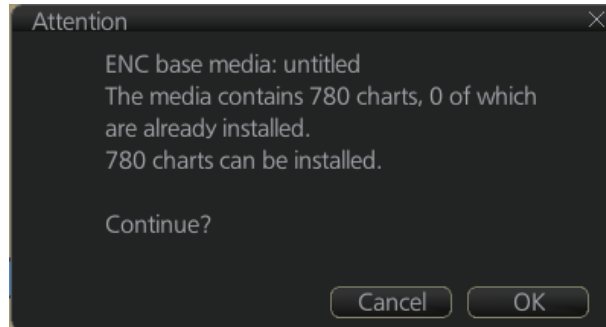

3. Click the [OK] button to install the charts. The [Install chart data] window appears and shows the percentage of completion, with digital and analog indications.

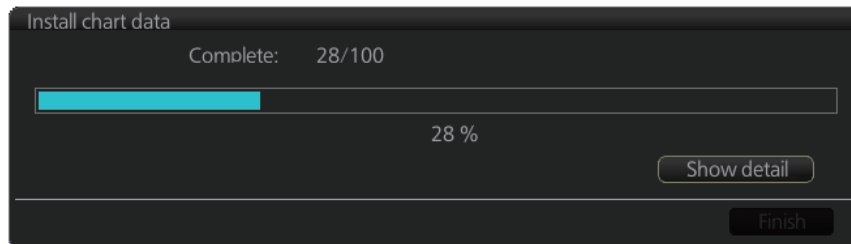

To show details during the installation, click the [Show detail] button.

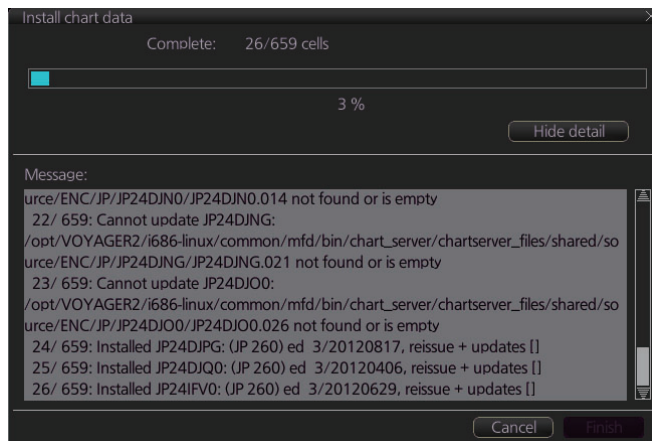

To close the [Message] window, click the [Hide detail] button.

- When the installation is completed, information about the installation appears in the [Result] window. Click the [Confirm] button to finish.

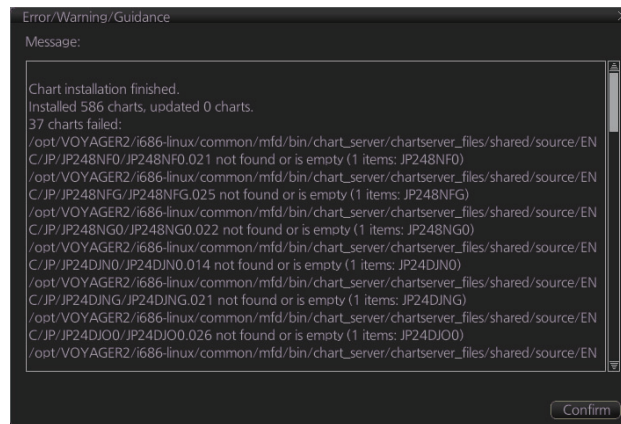

- If applicable, set the next sequential medium then repeat steps 2-4 to install the next database.
- After all necessary charts are installed, reset the power.

Note 1: When many charts are installed, the chart system checks for error in the installed chart data at the next power up. This is not an indication of malfunction.

Note 2: Previous versions of charts cannot be displayed if installed after installing the latest versions.

7.3 How to Delete ENC Licenses

- Get into the Chart maintenance mode.
- Click the [License] button on the InstantAccess bar™.
- Click the [ENC] tab as appropriate to show a list of licenses.

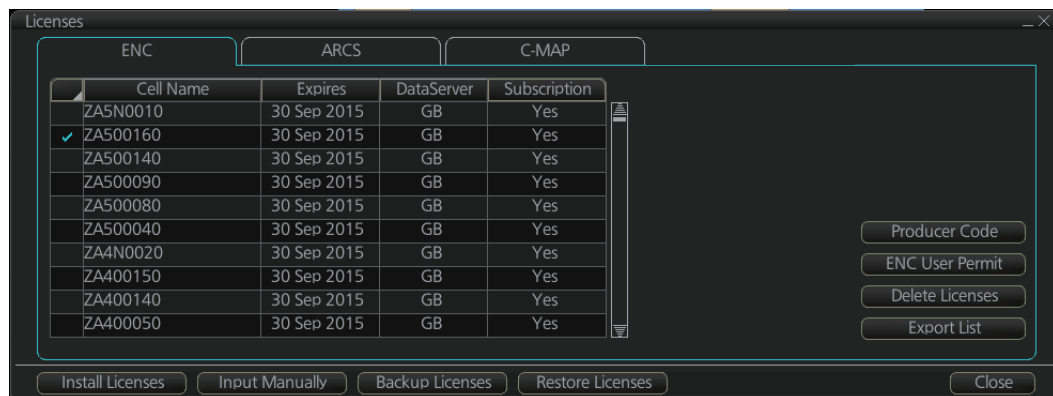

- Put a checkmark next to the license(s) to delete.
- Click the [Delete Licenses] button to delete the license(s) selected.
- Reset the power.

7.4 How to Update ENC Chart Manufacturer Info

An ENC chart has official or unofficial attributes. You can determine if an ENC chart is official or unofficial by viewing the chart manufacturer's information. Manufacturer's information has the following functions.

- [Filter] window (see section 7.13) can show or hide official or unofficial charts.
- Chart judgment with chart alert (see subsection 11.1.2). (Unofficial charts are subject to chart alert.)
- Unofficial charts are denoted on the [Check Results] of the [Route Plan] dialog box (see subsection 12.4.5). (Unofficial charts are subject to chart alert.)



The ENC manufacturer information can be updated as follows.

Note 1: ENC chart manufacturer information is built in the FMD beforehand, and it is not normally necessary to update the information.

Note 2: The ENC chart manufacturer information file has its own format. For details, contact a FURUNO dealer.

1. In the Chart maintenance mode, click the [License] button to show the [Licenses] dialog box.
2. Click the [ENC] tab.
3. Click the [Producer Code] button.

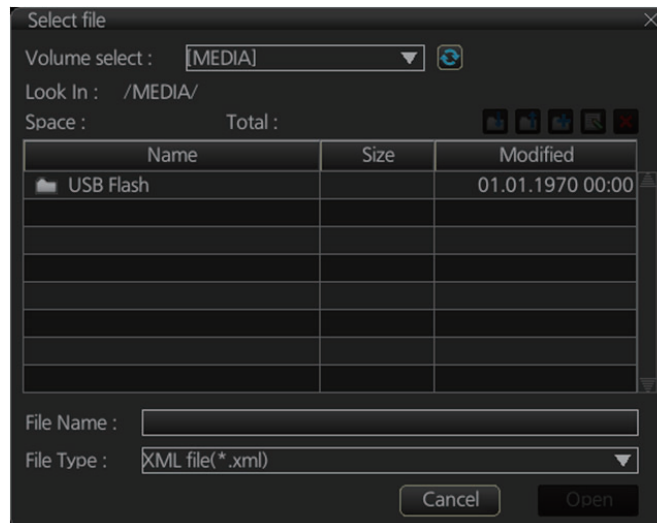

4. Select the ENC chart manufacturer information file then click the [Open] button.
5. Reset the power.

7.5 How to Install C-MAP Charts

Synchronize chart data before you install C-MAP charts, grouping the chart radar units to synchronize, otherwise the chart data cannot be shared. See the procedure in subsection 7.20.1 for how to synchronize chart data. If C-MAP charts are not synchronized after installation, delete all C-MAP charts, and do the above procedure again.

7.5.1 How to register the eToken

The eToken is a hardware mechanism (installed inside the processor unit) used for password authentication. Registration of the eToken is required only once, before you install the C-MAP database.

1. Get into the Chart maintenance mode then click the [License] button on the InstantAccess bar™ to show the [License] dialog box.
2. Click the [C-MAP] tab to show the [Licenses] dialog box for C-MAP.

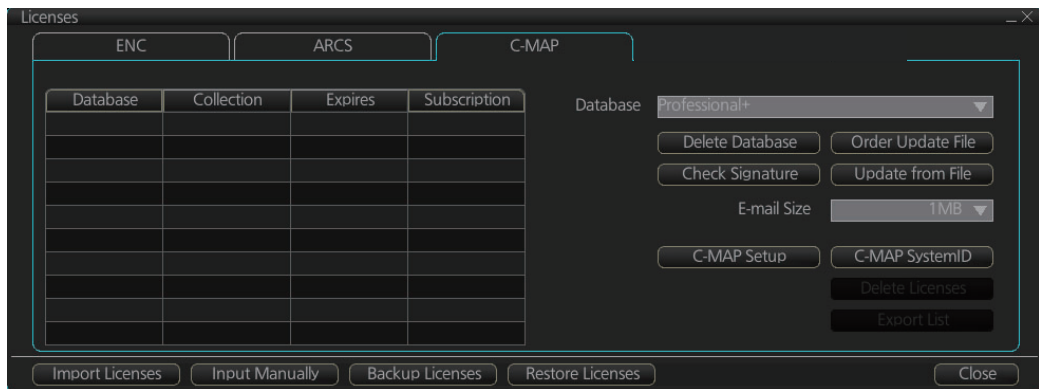

3. Click the [C-MAP Setup] button.
4. The confirmation message "Attention: C-MAP eToken will be initialized. Do you wish to continue?" appears. Click the [OK] button to continue and register the eToken.

Note 1: "C-MAP: No connection to eToken" disappears from the Permanent warning box after completion of the registration.

Note 2: You can show your C-MAP system ID by clicking the [C-MAP SystemID] button on the [Licenses] dialog box for C-MAP.

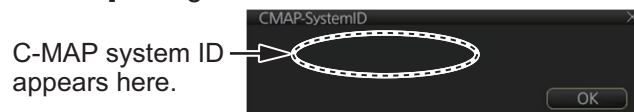

7.5.2 How to install the C-MAP database

When you install the C-MAP database from a medium, all data is saved to the SSD.

Note 1: To synchronize chart data between multiple units (FMD-3x00, FAR-3xx0 or FCR-2xx9), group the units (see section 7.20.1) you wish to synchronize before you install the charts. If the group setting is done after chart installation, the units will not synchronize. If, after setting the group and installing the charts, the charts are not synchronized, delete, then reinstall the chart.

Note 2: The installation of a chart cannot be cancelled while it is in progress. If you get an error message, try to install the charts again.

7. HOW TO MANAGE CHARTS

Note 3: The C-MAP database in the units selected for synchronization are synchronized at the successful completion of the database installation.

1. Insert the medium that contains the C-MAP database.
2. Get into the Chart maintenance mode then click the [AUTO Load] button on the InstantAccess bar™.
3. The [Install chart data] window appears and shows the percentage of completion, with digital and analog indications.

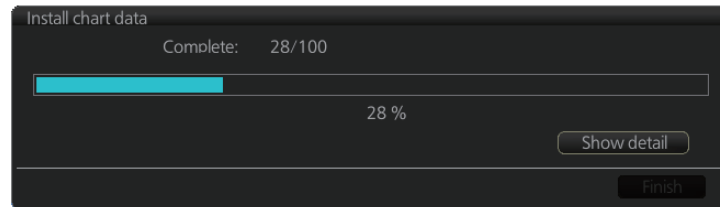

To show details during the installation, click the [Show detail] button.

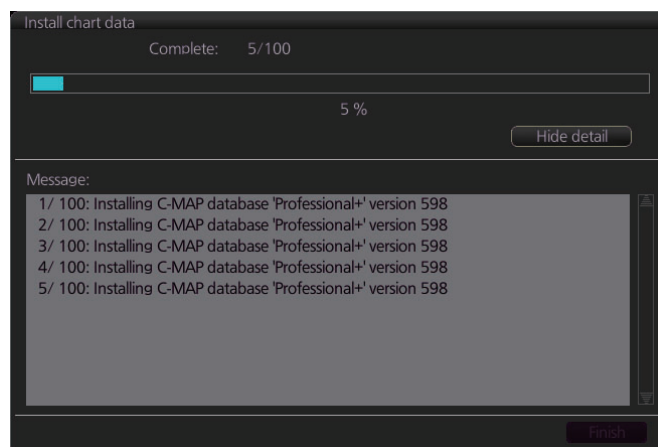

To close the [Message] window, click the [Hide detail] button.

4. When the installation is completed, information about the chart database installed appears in the [Result] window. Click the [Confirm] button to finish.

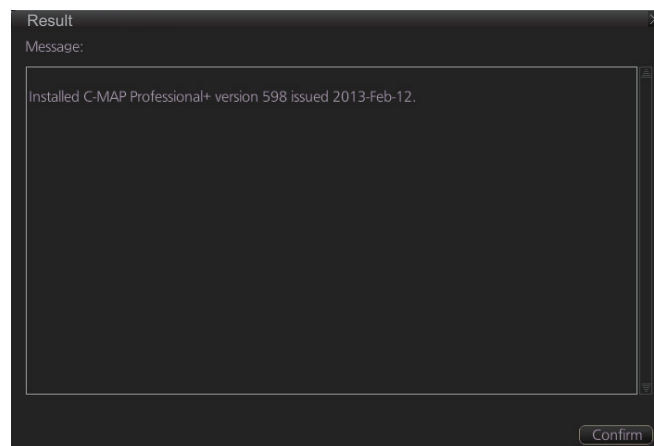

5. If applicable, set the next sequential medium and repeat steps 2-3 to install the next databases.
6. After all databases are installed, reset the power.

Note 1: If, after installation, C-MAP charts do not appear, delete all corresponding charts and then reinstall them.

Note 2: Synchronization is not done for charts which could not be installed successfully. Reinstall failed charts.

7.5.3 How to install C-MAP licenses

A C-MAP license should be installed using the automatic installation method shown below. If the automatic installation fails, try the manual installation method.

Automatic installation

1. Set the medium (DVD, USB flash memory, etc.) that contains the C-MAP license.
2. Get into the Chart maintenance mode then click the [License] button on the InstantAccess bar™.
3. Click the [Import Licenses] button.
4. Select the medium that contains the license then click the [Open] button.
5. Click the [OK] button to install the license.
6. Click the [Close] button to finish.
7. Reset the power.

Manual installation

1. Click the [CHARTS] button on the Status bar to go the Chart maintenance mode, then click the [License] button on the InstantAccess bar™.
2. Click the [Input Manually] button to show the [Input License Manually] box.

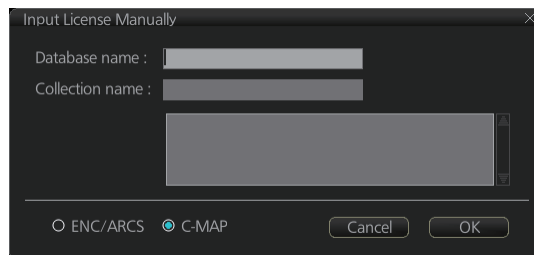

3. Select the type [C-MAP] at the bottom of the window.
4. Enter the [Database name] and [Collection name] information as shown in the table below. Enter the names exactly as shown to ensure correct installation.

Chart type	Name to enter	
	Database name	Collection name
PROFESSIONAL+	Professional+	Enter "Zone *" (without quotations, *= contracted zone number) Ex. Zone 1
ENC SERVICE	ENC	Enter "Zone * ENC" (without quotations, *= contracted zone number) Ex. Zone 1 ENC
ENC+ SERVICE	ENC+	
ADMIRALTY ENC SERVICE	CAES	Enter the contracted collection name.

5. Enter the license (max. 16 characters) in the bottommost window.
6. Click the [OK] button to install the license.
7. Reset the power.

7.5.4 How to generate and order an update file

To update the C-MAP chart database, you have to generate an update file, and e-mail the file directly to C-MAP. The update file defines coverage of charts you can display on your chart system.

1. Connect a USB flash memory to the USB port on the Control Unit.
2. Get into the Chart maintenance mode then click the [License] button on the InstantAccess bar™.
3. Click the [C-MAP] tab to show the [Licenses] dialog box for C-MAP.
4. From the [E-mail Size] drop-down list, select the size of the update file. The choices are [100KB], [200KB], [300KB], [400KB], [500KB], [750KB], [1MB], [2MB], [3MB], [4MB], [10MB], [Unlimited]. This is the size of the data file in an e-mail. The file may be sent in pieces depending of the size selected.
5. Click the [Order Update File] button. A file name (C-MAP system ID and chart type) is automatically created, with the extension .ord.

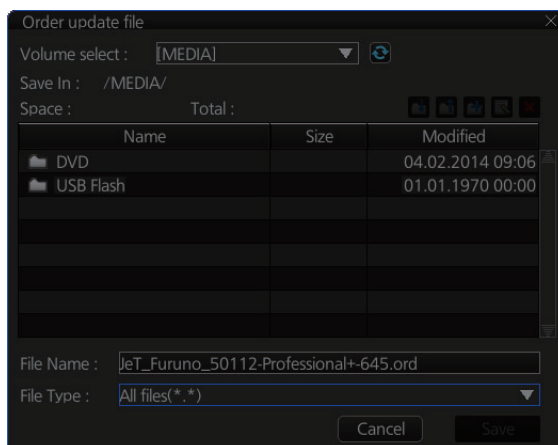

6. Select the USB flash memory.
7. Click the [Save] button to save the order file to the USB flash memory.
8. Send the order file to update@c-map.com.

Within a few minutes you will receive a file that includes the terms for using the chart service and the chart updates. Save the file to a USB flash memory and apply it as shown in the next section.

7.5.5 How to apply the update file

1. Insert the USB flash memory that contains the update file (.ans extension) into the USB port on the Control Unit.
2. Get into the Chart maintenance mode then click the [License] button on the InstantAccess bar™.
3. Click the [C-MAP] tab to show the [Licenses] dialog box for C-MAP.
4. Click the [Update from File] button.
5. Find the update file on the USB flash memory then click the [Open] button.

7.5.6 How to check license status

You can check the status of your chart licenses with the following procedure. The chart database and respective licenses must be installed before you check the status.

1. Get into the Chart maintenance mode then click the [License] button on the InstantAccess bar™.
2. Click the [C-MAP] tab to show the C-MAP license dialog.
3. Click the [Check Signature] button at the right-side of the dialog. The results appear in the window as "Ok" or "Not Ok". Where the results appears as "Not Ok", consult your local dealer.
4. Click the [OK] button to close the results window.

7.6 How to Delete a C-MAP Database

If you are going to delete all C-MAP databases, turn off chart synchronization (see section 7.20) and delete the databases from each unit.

1. Get into the Chart maintenance mode then click the [License] button on the InstantAccess bar™.
2. Click the [C-MAP] tab to show the [Licenses] dialog box for C-MAP.
3. Select the database to delete with the [Database] pull-down list.
4. Click the [Delete Database] button.
5. Reset the power.

7.7 How to Export a List of Charts

Get into the Chart maintenance mode, click the [Manage Charts] button on the InstantAccess bar™ to show the [Manage Charts] dialog box. Check the charts to add to the list. Click the [Export List] button to export the checked charts to a USB flash memory, in .txt format.

7.8 How to Export a List of Specific Licenses

You can export a list of your ENC or C-MAP licenses to a USB flash memory, in .txt format.

1. Set a USB flash memory in the USB port on the Control Unit.
2. Get into the Chart maintenance mode then click the [License] button.
3. Click the [ENC] or [C-MAP] tab.
4. Click the [Export List] button.
5. Change the file name at [File Name] if desired.
6. Select the USB flash memory then click the [Save] button.
7. Click the [OK] button to finish.

7.9 How to Show the ENC Permit

1. Get into the Chart maintenance mode then click the [License] button.
2. Click the [ENC] tab.
3. Click the [ENC User Permit] button to show the ENC permit.

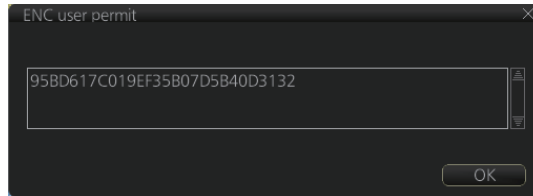

4. Click the [OK] button to finish.

7.10 How to Backup, Restore Licenses

You can make backup copies of your ENC, ARCS and AVCS (AIO) licenses and save them to a USB flash memory. If re-installation of the licenses becomes necessary, you can reinstall them from the USB flash memory. The backup and restore functions are not available with C-MAP charts.

To backup licenses:

1. Insert a USB flash memory into the USB port on the Control Unit.
2. Get into the Chart maintenance mode then click the [License] button on the InstantAccess bar™ to show the [Licenses] dialog box.
3. Click the [Backup Licenses] button.
4. Select the USB flash memory then select the folder in which to save the licenses, then click the [OK] button.
The license files (ENCpermit.dat, ARCSpermit.dat) are saved in the selected folder.
5. Click the [OK] button.

To restore licenses:

1. Insert the USB flash memory that has the licenses into the USB port on the Control Unit.
2. Get into the Chart maintenance mode then click the [License] button on the InstantAccess bar™ to show the [Licenses] dialog box.
3. Click the [Restore Licenses] button.
4. Select the USB flash memory then select the folder in which licenses are saved, then click the [OK] button.
5. Click the [OK] button.

7.11 How to View Permit Expiration Date

Permits are used to control the right to use chart data in this chart system. A permit is connected to the edition of a chart. Permits are issued in two different types:

- **Subscription permit:** This type of permit includes updates for subsequent 3, 6, 9 or 12 months.
- **One-Off permit:** This type of permit includes only updates up to the issue date of the permit.

The expiry date of a permit controls the installation of Base charts and their updates to the chart. The system will warn you when you are installing charts or updates that are issued less than 30 days before the expiration date of a permit. If a permit has expired, it is impossible to install a chart or its update that was issued after the expiration date of the permit. The user has a right to view a chart forever, except C-MAP charts that have viewing periods which end two months after the expiry date of the license. If the charts are not updated regularly it will not complete the requirements for having up-to-date charts. To view the permit status of a chart, click the [License] button on the InstantAccess bar™ and then click the applicable "chart" tab ([ENC], or [C-MAP]).

The example below shows the status of ENC charts. The expiration date of each cell appears in the [Expires] window.

Cell Name	Expires	DataServer	Subscription
ZA5N0010	30 Sep 2015	GB	Yes
ZA500160	30 Sep 2015	GB	Yes
ZA500140	30 Sep 2015	GB	Yes
ZA500090	30 Sep 2015	GB	Yes
ZA500080	30 Sep 2015	GB	Yes
ZA500040	30 Sep 2015	GB	Yes
ZA4N0020	30 Sep 2015	GB	Yes
ZA400150	30 Sep 2015	GB	Yes
ZA400140	30 Sep 2015	GB	Yes
ZA400050	30 Sep 2015	GB	Yes

Subscription warnings for RENC

If you have at least one subscription-type permit, the system will automatically warn you about the expiration date of your subscription license, in the Permanent warning box.

Note: If you change service provider for some reason, it is recommended that you remove all the charts from this chart system before installing new charts of new service provider.

7.12 How to Display Install/Update History

You can see a history of chart installations and updates. On the InstantAccess bar™, click the [Log] and [Update Log] buttons followed by the [ENC] or [C-MAP] button. The example below shows the install/update history for ENC charts.

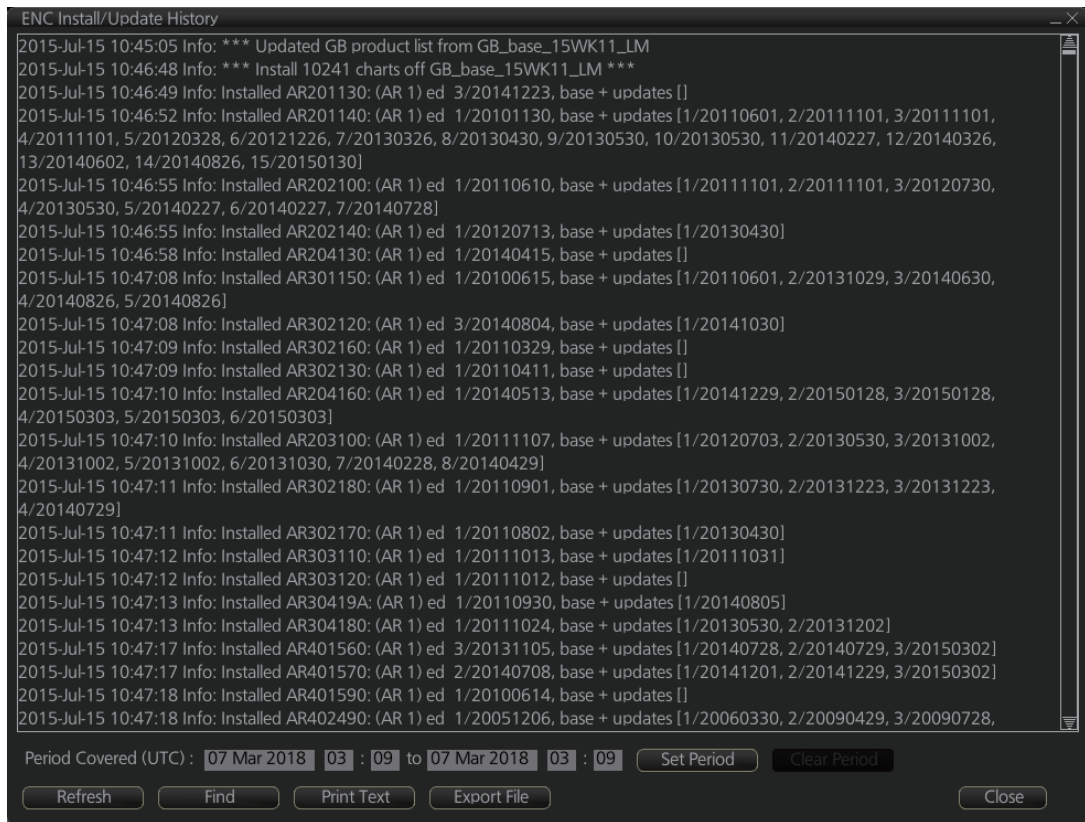

You can filter the log with [Period Covered (UTC)]. Enter the period to display then click the [Set Period] button. Click the [Clear Period] button to display all entries. The [Refresh] button updates the list. [Print Text] prints hard copy of the history. [Export File] exports the log file. The file name "UpdateLog_***YYYYMMDDhhmmss.txt" is automatically assigned. (***=ENC, CMAP)

The [Find] button searches required text string as follows:

1. Click the [Find] button to show the [Find text] box.

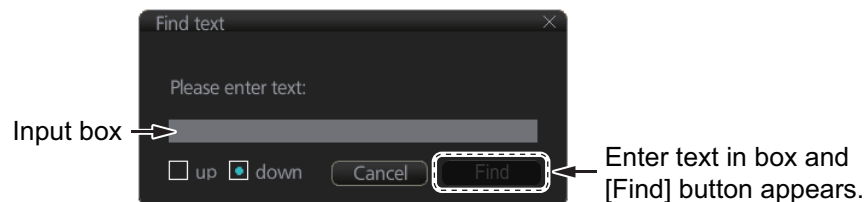

2. Click the input box then enter the text to search.
3. Select the search direction with the [up] or [down] radio button.
4. Click the [Find] button. The first matching text is highlighted in yellow at the top of the screen.
5. To continue the search click the [Find] button. To cancel the search, click the [Cancel] button.

7.13 Catalog of Chart Cells

A catalog is used to view graphical coverage of the charts stored in your SSD. Available charts are displayed showing their border limits. Note that sometimes the real coverage of the charts may be considerably less than the declared limits of it.

To display the catalog, get into the Chart maintenance mode then click the [Manage Charts] button on the InstantAccess bar™. The [Filter] window lets you select what to display. Check or uncheck items as appropriate.

The screenshot displays the 'Filter window' and 'Manage Charts' interface. The 'Filter window' is overlaid on a map of the North Atlantic, showing various chart cells with their border limits. The 'Filter window' includes the following options:

- Chart Type: ENC, ARCS, C-MAP
- Availability: Available, Unavailable
- License: Valid, Missing/Expired
- C-MAP Collections: [Dropdown]
- Official: Official, Unofficial
- Up-to-date: Up-to-date, Not Up-to-date
- Purpose: Overview, Approach, General, Harbour, Coastal, Berthing
- Group: [Dropdown] [Edit]
- Route: [Dropdown] [Select]

The 'Manage Charts' window below the map shows a table of chart data:

Type	Chart Name	Data Server	Status	Action
ENC	AR201010		not installed	
ENC	AR201140		not installed	
ENC	AR202100		not installed	
ENC	AR202140		not installed	
ENC	AR202150		not installed	
ENC	AR203100		not installed	
ENC	AR203170		not installed	
ENC	AR204130		not installed	
ENC	AR204160		not installed	
ENC	AR301150		not installed	

The 'Data Location' dropdown is set to 'Internal'. Below the table are buttons for 'Open Chart', 'Note', 'Print List', and 'Export List'. At the bottom of the 'Manage Charts' window are buttons for 'Import Charts', 'Delete Charts', 'Individual Update', and 'Close'.

- 1) Chart Type
ENC: Display ENC charts.
ARCS: Display ARCS charts.
C-MAP: Display C-MAP charts.
- 2) Availability
Display available or unavailable charts.
- 3) License
Valid: Cell with valid license.
Missing/Expired: Cell with missing or expired license.
Valid + Missing/Expired: Display cell regardless of license.
Uncheck both: Hide all cells.
- 4) C-MAP Collections
A collection is a pre-defined dataset, the contents of which can be defined by zone, individual chart or any of those combinations. Applicable to C-MAP charts also.

7. HOW TO MANAGE CHARTS

- 5) Official
Display official or unofficial charts.
- 6) Up-to-date
Display charts which are or are not up to date.
- 7) Purpose
Display chart according to its purpose - Overview, General, Coastal, NtoM, Approach, Harbour, Berthing.
- 8) Group
See the next section for how to group charts.
- 9) Route
The cells within a route and route waypoints (start and end points settable) are shown. When checked, the [Action] column of the [Manage Charts] dialog box shows the necessary action to be taken for each chart within the specified route in order to navigate the route.

Action	Description
[install]	License is installed, however the chart has not been installed. Install the chart.
[no action]	The latest chart is installed, and the license expiration date is 30 or more days away.
[order]	License not purchased. Order the license.
[reinstall]	The chart is corrupted. Reinstall the chart.
[remove]	Chart status is "withdrawn". It is not necessary to purchase the license.
[renew]	The latest chart is installed, however the license expires within 30 days. Purchase the license.
[update]	Chart is not up-to-date. Install the latest chart.

Further, the range of the cell (square region) and the range in which the cell has actual data do not necessarily match. If the cell has not been purchased, the cell range is filtered, and if it has been purchased, the actual data range is filtered.

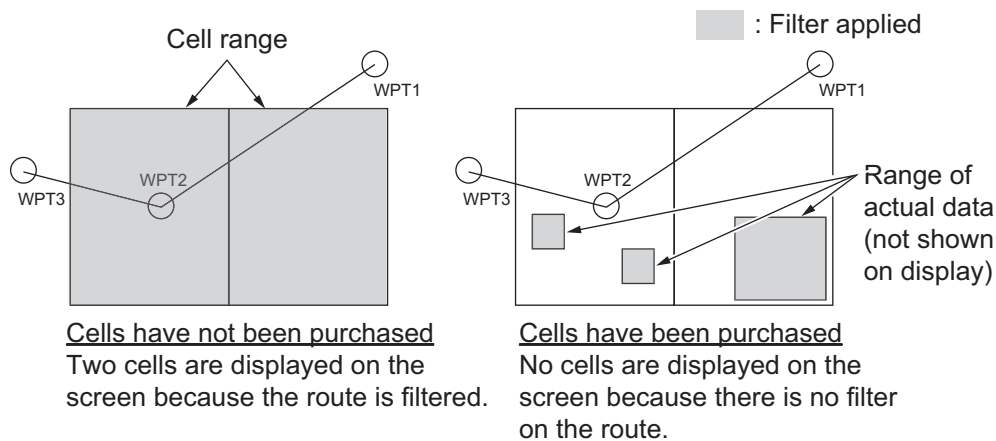

- 10) [Set Default] button
Restores all factory defaults for items in the window.
- 11) Apply button
Changes made to the filter window are applied to the chart. This button is only visible if changes are made to the filter window settings.
- 12) Chart boundary boxes
Define the area covered by a chart and are color-coded according license and permit status.

13) Line color legend

The line color legend provides information about license validity.

Color	Message	Color	Message
Internal charts		External charts	
Green	Chart is up-to-date	Green	Already installed and up-to-date
Dark Green	Permit will expire within 30 days	Yellow	Can be installed/updated but a warning
Yellow	Permit missing/expired	Orange	Already installed but not up-to-date
Orange	Chart is not up-to-date	Magenta	Can be installed/updated
Magenta	Permit available, chart not installed	Red	No valid permit
Red	Permit not available	Gray	Cannot be installed/updated
Blue	Chart's status is unknown		
Gray	Chart is withdrawn or corrupted		

7.13.1 How to group chart cells

You can define groups of like-format chart cells. This means you can collect related charts, for example, all cells that cover a route from Liverpool to New York or all cells available from a National Hydrographic Office.

You can make a group and define charts from the [Edit Group] dialog box.

How to make a new group of chart cells

1. In the Chart maintenance mode, click the [Manage Charts] button on the InstantAccess bar™.
2. Click the [Edit] button in the [Filter] window to show the [Edit Group] dialog box.

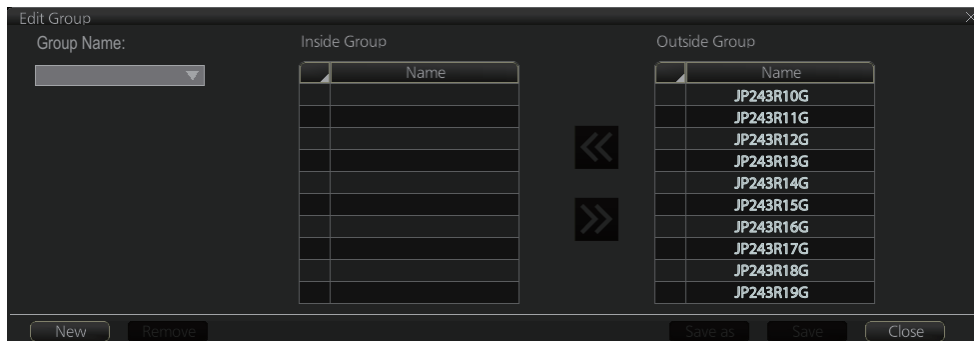

3. Click the [New] button.
4. In the [Outside Group] window, click the box to the left of the chart cell you want to add to the group to show a checkmark. (A context-sensitive menu with [Select All] and [Deselect All] functions is available by right-clicking the box to the left of [Name], in either window.)
5. After you have selected the cells to add to the group, click the [<<] button to move the names of the selected cells to the [Inside Group] window. If you want to remove a chart from the group, select it then click the [>>] button.
6. Click the [Save] button.
7. Enter a name for the group, using the keyboard on the Control Unit or software keyboard, then click the [OK] button.
8. Click the [Close] button to finish.

How to edit a group of chart cells

You can edit a group of chart cells from a group as follows:

1. In the Chart maintenance mode, click the [Manage Charts] button on the InstantAccess bar™ to show the [Filter] window.
2. Click the [Edit] button.
3. Select the name of the group with the pull-down list at the item [Group Name].
4. In the [Inside Group] window, click the box to the left of the chart cell you want to remove from the group to show a checkmark. (A context-sensitive menu with [Select All] and [Deselect All] functions is available by right-clicking the box to the left of [Name].)
5. After you have selected the charts to remove to the group, click the [>>] button to remove the selected charts cells from the group.
6. Click the [Save] button.
7. Click the [Close] button to finish.

How to delete a group of chart cells

You can delete group of chart cells as follows:

1. In the Chart maintenance mode, click the [Manage Charts] button on the InstantAccess bar™ to show the [Filter] window.
2. Click the [Edit] button.
3. Select the name of the group with the pull-down list at the item [Group Name].
4. Click the [Remove] button.
5. Click the [OK] button.
6. Click the [Close] button to finish.

How to select the group to view

1. In the Chart maintenance mode, click the [Manage Charts] button on the InstantAccess bar™ to show the [Filter] window.
2. Select the group to view from the pull-down list at [Group].
3. Click the [Close] button to finish.

7.13.2 How to view status of chart cells

The [Cell Status] dialog box shows the status of the chart cells stored in the system. To show this dialog box, get into the Chart maintenance mode then click the [Cell Status] button on the InstantAccess bar™.

Type	Chart Name	Data Server	Edition/ Issue Date	Update: Num/Date	Status
ARCS	100	GB	06 May 1994	-/-	up to date
ARCS	1000	GB	05 Mar 2009	-/28 May 2015	not up to date
ARCS	1001	GB	05 Mar 2009	-/28 May 2015	up to date
ARCS	1002	GB	27 Nov 1912	-/-	not up to date
ARCS	1003	GB	15 Jan 2004	-/25 Jun 2015	up to date
ARCS	1004	GB	03 Oct 2013	-/-	up to date
ARCS	1005	GB	30 Apr 2015	-/-	up to date
ARCS	1006	GB	03 Oct 2013	-/-	up to date
ARCS	1007	GB	09 Apr 2015	-/11 Jun 2015	up to date
ARCS	1008	GB	09 Apr 2015	-/-	not up to date

- [Type]: Type of chart cell, ENC or C-MAP.
- [Chart Name]: Chart name
- [Data Server]: The name of the data server where the chart was downloaded from.
- [Edition/Issue Date]: Edition no. and issued date of the chart cell.
- [Update: Num/Date]: No. and date of the update of the chart cell.
- [Updated]: The update status for the selected cell. "up to date" is shown for cells that are up-to-date, "not up to date" is shown for cells that are not up-to-date, "withdrawn" is shown if a cell is canceled, "unknown" is shown if the cell is not delivered as part of a data service and "broken" is shown if the cell is corrupted.
- [Status]:
 - [up to date]: Cell is up-to-date.
 - [not up to date]: Cell is not up-to-date.
 - [not installed]: Cell is not installed.
 - [withdrawn]: Cell has been withdrawn (cell will not be updated).
 - [unknown]: Cell is not delivered as part of a data server service (ex. unencrypted ENC).
 - [broken]: Cell is corrupted.

7.14 How to Open Charts

In the Chart maintenance mode, click the [Manage Charts] button on the InstantAccess bar™ to display the dialog box shown below. Select the chart to open then click the [Open Chart] button.

Type	Chart Name	Data Server	Status	Action
ENC	JP13UV00	GB	not up to date	
ENC	JP13UV10	GB	not up to date	
✓ ENC	JP13UV20	GB	not up to date	
ENC	JP13UV30	GB	not up to date	
ENC	JP148NF0	GB	not up to date	
ENC	JP148NG0	GB	not up to date	
ENC	JP148NH0	GB	not up to date	
ENC	JP148NI0	GB	not up to date	
ENC	JP148NJ0	GB	not up to date	
ENC	JP14CCJ4	GB	not up to date	

7.15 How to Print Chart List, Cell Status List

7.15.1 How to print the chart list

1. In the Chart maintenance mode, click the [Manage Charts] button on the InstantAccess bar™ to show the [Manage Charts] dialog box.
2. Check the charts to print.
3. On the [Filter] window, check the information to print.
4. Click the [Print List] button to print. (If you have selected more than 30 charts, the message "The number of page is 1. Do you want to continue?." appears. Click the [OK] button to continue, or the [Cancel] button to escape.)

```

Chart Management Report
Ship Name:                               Call Sign:
IMO Number:                              MMSI Number:
Printing Date: 2013-06-18 21:14:00
Data Location: Internal

Filter
Chart Type: ENC/ARCS/C-MAP                Availability: Available
License: Valid/Missing/Expired            Dynamic License: DL/Non-DL
Official: Official/Unofficial             Up-to-date: Up-to-date/Not Up-to-date
Purpose: Overview/General/Coastal/Approach/Harbour/Berthing
Group: test_all

Status Summary
yes                                     1251/1884
no                                      633/1884

-----
Type      Chart Name  Data Server  Status
-----
ENC      AU130060    GB           yes
ENC      AU130090    GB           yes
ENC      AU130120    GB           yes
ENC      AU130150    GB           yes
    
```

Example

Description of chart list printout

Item	Description
[Ship Name]	Name of ship
[IMO Number]	Ship's IMO number
[Call Sign]	Ship's call sign
[MMSI Number]	Ship's MMSI number
[Printing Date]	Date list printed
[Data Location]	Location of charts; normally [Internal].
[Filter]	Settings of the items in the [Filter] window.
[Status Summary]	[yes]: charts with yes status/total number of charts [no]: charts with no status/total number of charts

7.15.2 How to show the cell status list

1. In the Chart maintenance mode, click the [Cell Status] button on the InstantAccess bar™ to show the [Cell Status] dialog box.
2. On the [Filter] window, check the information to show.
3. Click the [Create Report] button to generate the report. A report for all cells shown in the [Cell Status] dialog appears.

Note: If there are no cells shown in the [Cell Status] dialog box, the [Create Report] button is not available.

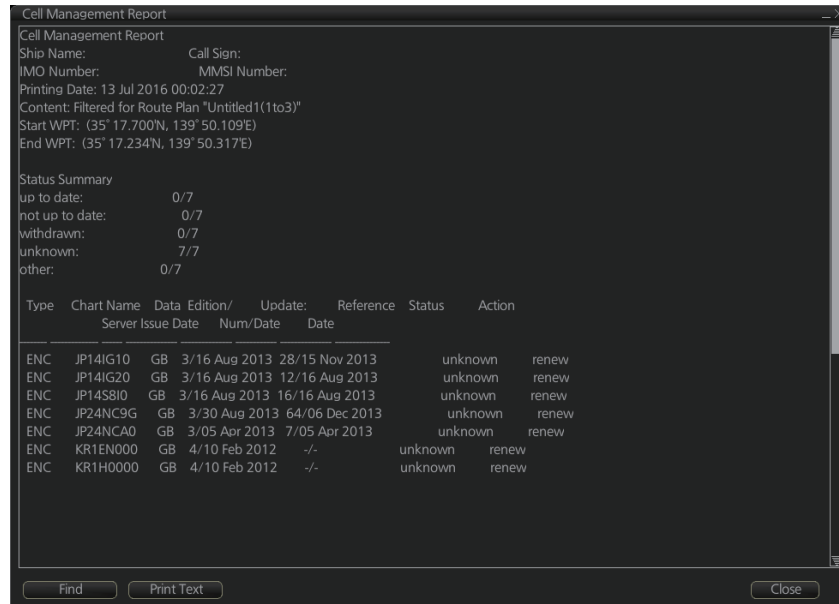

Example

4. To print the report, click the [Print Text] button.

Description of cell status printout

Item	Description
[Ship Name]	Name of ship
[IMO Number]	Ship's IMO number
[Call Sign]	Ship's call sign
[MMSI Number]	Ship's MMSI number
[Printing Date]	Date list printed
[Content]	Settings of the items in the [Filter] window.
[Status Summary]	[up to date]: charts with "up to date" status/total number of charts [not up to date]: charts with "not up to date" status/total number of charts [withdrawn]: charts with "withdrawn" status/total number of charts [unknown]: charts with "unknown" status/total number of charts [other]: charts with "other" status/total number of charts

7.16 How to Delete Charts

If you are going to delete all charts, turn off chart synchronization (see section 7.20) and delete charts from each unit.

1. Click the [Manage Charts] button to show the [Manage Charts] dialog box.
2. Click the block to the left of the chart to remove, a checkmark appears. A context-sensitive menu with [Select All] and [Deselect All] functions is available by right-clicking the block to the left of [Type].
3. Click the [Delete Charts] button to delete the charts selected.
4. Reset the power.

7.17 How to Show Publishers Notes for ENC Charts

You should read the text file associated with each catalog, which you can view when installing a chart from a medium. Click the [Note] button in the [Manage Charts] dialog box. You can print a hard copy with the [Print Text] button.

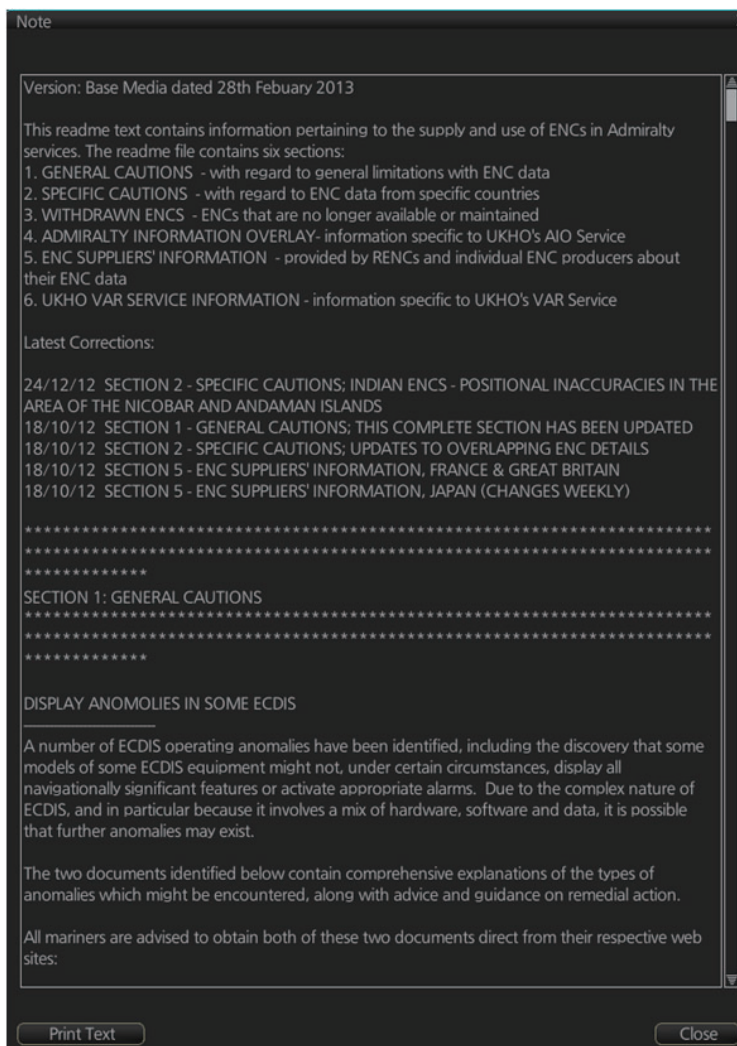

7.18 How to Find the Chart Type

The electronic chart system can display more than one ENC chart cell at a time. This feature is called multi-cell display. If one ENC chart cell does not cover the whole display, the system opens more ENC chart cells for display, if appropriate cells for the displayed area are available. The Own ship functions box shows information about ENC chart cells displayed on the electronic chart display area. When automatic TM reset is active, the information is displayed with reference to your ship's position. If TM reset is OFF, the information is displayed with reference to current cursor position.

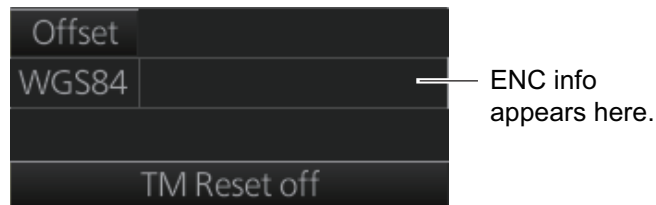

Chart type indication

No indication (Official ENC chart)

“Non-ENC data” (Unofficial ENC chart, indication in yellow)

“ENC data available” (Currently, RNC chart is in use, but ENC material is available. Indication shown in yellow.)

7.19 How to Update ENC, C-MAP Charts Manually

Manual update may include deleting an already existing object, modifying a position or other characteristics of an already existing object or inserting of a new object. In this system, manual updates are stored in a common database.

Mariners cannot permanently remove any of the official objects from the chart display. If a mariner needs to make obsolete any official objects which were entered manually, he “deletes” them. Then, in practice, the deleted objects are still visible, but a diagonal line on the object indicates it is a deleted object.

However, a mariner can remove objects that he has inserted himself.

Note that the manual updates have no automatic connection to any automatic update received later for charts. If a manual update itself became obsolete, because the official chart has been updated to include the update defined as a manual update, the mariner must himself delete the obsolete manual update in question.

The system records complete usage of manual updates. All deletions, modifications and insertions are recorded and time stamped. If the mariner wishes to see what kind of manual updates he had in the past, for example, two weeks ago, he uses Update History to specify the relevant date range. For information on how to set Display date and Update Review dates, see section 9.2.4.

Note 1: Do not manually update charts while charts are being synchronized. Wait until synchronization is completed.

Note 2: When any chart is updated, all checked routes are reverted to unchecked status. Use the [Check Route] button on the [Alert Parameters] page to re-check routes before starting any voyage.

7.19.1 How to insert update symbols

A manual update symbol can be added as shown in the procedure below.

Note 1: If the system freezes when updating the drawing type [Area], reset the power.

Note 2: An update symbol that straddles the international date line cannot be edited. In this case, insert the same symbol on each side of the line.

Note 3: Do not do manual updating during chart synchronizing. Do the updating after the completion of synchronizing or do the updating where the chart is installed.

1. Go to the Voyage navigation mode.
2. Click the [Manual Update] button on the InstantAccess bar™ to open the [Manual Update] dialog box.
3. Click the [Planning] tab.

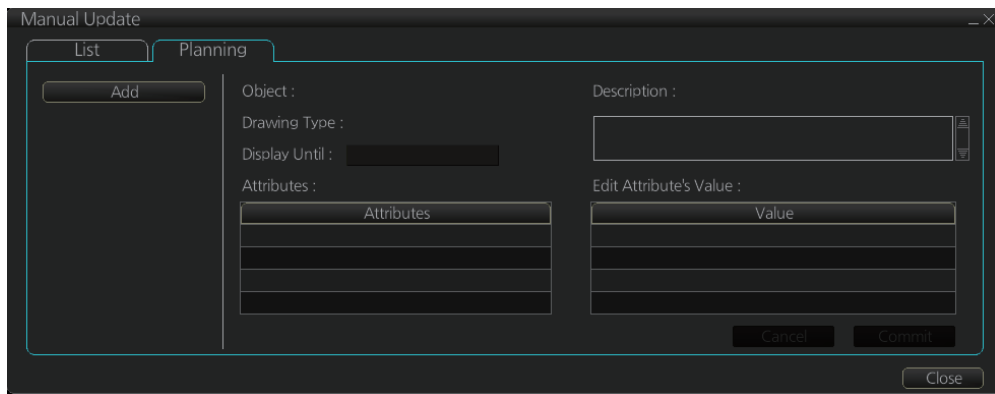

4. Click the [Add] button.
 - Note:** This window can also be shown from the context-sensitive menu. Right-click the display area then select [Manual Update] and [Add New].
5. Use the [Drawing Type] pull-down list to select drawing type: [Point], [Line] or [Area].
6. Click desired object.
7. Put the cursor on the location where to insert the symbol then left click. The [Manual Update] dialog box shows:
 - [Object]
 - [Drawing Type]

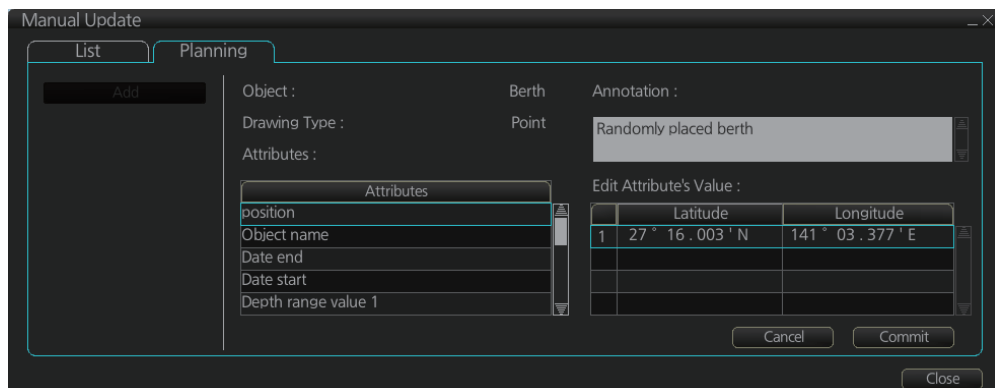
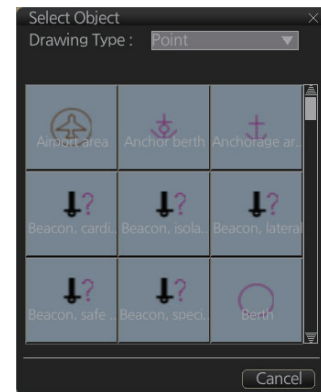

8. You can add a comment related to a manual update object in the [Annotation] box.

9. To add textual information to an attribute, select the attribute from the [Attributes] window then add text in the [Edit Attribute's Value] window.
The [Date end] factory default is set to three months from the date of insertion and applies to all chart items. You can adjust the dates here.
10. Click the [Commit] button to add all selected objects to the chart.

Note 1: If there is no textual information entered in the [Annotations] window, a confirmation message appears when you click the [Confirm] button. Check that the information is correct and click [Yes] or [No] as appropriate.

Note 2: A manual update object is displayed until the display until date entered for it has passed. If the object remains on the screen after the display until date, do some operation on the screen to refresh the screen to erase the object.

7.19.2 How to copy objects from an official chart and insert them

You can copy objects from an official chart and insert them as a manual update with the following procedure:

1. Right-click the object you wish to copy to show the context-sensitive menu, the click [Manual Update] and [Copy From Chart]. The Copy Chart dialog box appears.

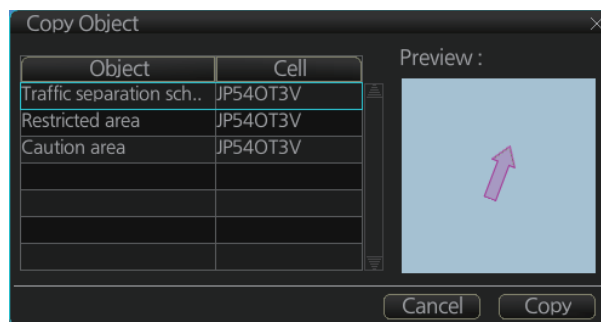

2. Click the object to copy, then click [Copy]. The object is copied to the [Manual Update] dialog box.
3. Referring to step 8 and step 9 in section 7.19.1, edit the object as required.
4. Click the [Commit] button to add the object to the chart.

Note: If there is no textual information entered in the [Annotations] window, a confirmation message appears when you click the [Confirm] button. Check that the information is correct and click [Yes] or [No] as appropriate.

7.19.3 How to ignore chart objects

Manually entered update symbols cannot be deleted until the display until date arrives or is changed. However, you can mark the symbol to indicate that it can be ignored.

1. Put the cursor on the symbol then right-click to show the context-sensitive menu.
2. Select [Manual Update] and [Delete].

The symbol is marked with a diagonal line.

Deleted symbol is marked with a diagonal line



7.19.4 How to delete (hide) a chart object

You can hide a manually inserted chart object by doing the following:

1. Referring to step 1 and step 2 of section 7.19.1, show the [Manual Update] dialog box.
2. Click the [List] tab.
3. Click the object to hide, then click the [Remove] button. The selected item is hidden from the chart display.

7.19.5 How to modify existing update symbols

The position, display until date and description of an update symbol can be modified. A symbol that is marked as “deleted” cannot be modified.

1. Follow steps 1-2 in subsection 7.19.1 to display the [Manual Update] dialog box.
2. Click the [List] tab.

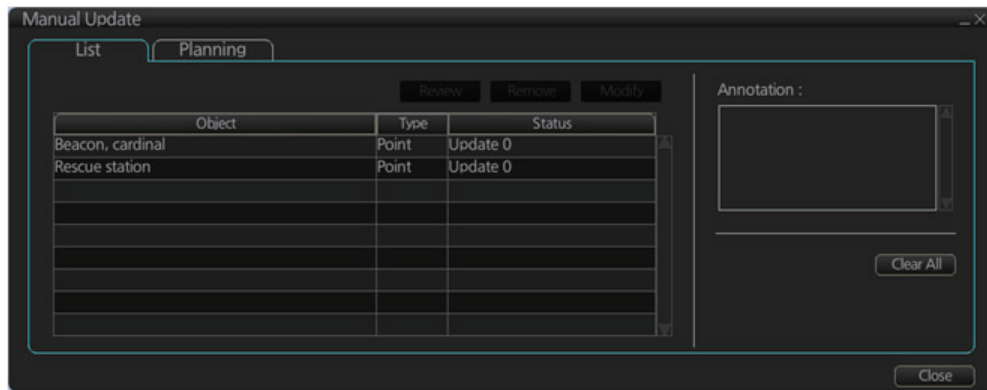

3. Select the object to modify then click the [Modify] button. The [Planning] dialog box appears.
4. Modify the object referring to steps 8-9 in subsection 7.19.1.
Note: The annotation for all modified objects is reset to blank when the Modify button is clicked. Check and re-input the annotations as necessary.
5. Click the [Commit] button. A confirmation dialog appears. Click [Yes] or [No] as appropriate.

7.19.6 How to review a chart object

You can review a chart object in order to see the object before any changes were made. To review an object, do the following:

1. Follow steps 1-2 in subsection 7.19.1 to display the [Manual Update] dialog box.
2. Click the [List] tab.
3. Select the object to review then click the [Review] button.

Manually updated objects appear with a thick line, as shown in the figure to the right.

Objects under review appear in the [Manual Update] dialog box with the status "Review x" (x indicates the state at which you are viewing the reviewed object). The object appears in a pre-modified state, and with each press of the [Review] button, one modification is “reverted”.

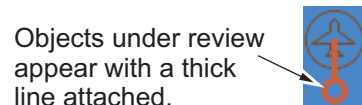

7.19.7 How to remove all manual update data

You can remove all manual update data by doing the following:

1. Do steps 1-2 in subsection 7.19.1 to display the [Manual Update] dialog box.
2. Click the [List] tab.
3. Click the [Clear All] button.

7.20 How to Synchronize Chart Data

This section shows you how to synchronize chart data between FMD-3xx0, FCR-2xx9 and FAR-3xx0 units, so that all units share the same chart data. Synchronization can be done automatically or manually (see subsection 7.20.2), however all units selected for synchronization must be powered to complete the synchronization. Synchronization includes the following actions:

- Synchronize public keys
- Synchronize chart permits and licenses
- Synchronize chart data
- Synchronize manual updates

Note 1: Before synchronizing chart data, confirm that all units selected for synchronization are powered. (Do not turn off a unit during synchronizing.) If a unit is turned off during the synchronizing, do the following on the unit which contains the medium:

- Open the [Sync Status] dialog box then click the [Disable Sync] button to disable synchronization. Power all units registered for synchronization, then click the [Urge Sync] button on the [Sync Status] dialog box on the unit containing the media to forcibly synchronize.
- Make a group of all the units currently powered, referring to subsection 7.20.1, and register the group with [Grouped with This Unit]. Reset the power on all units selected for synchronization.

Note 2: C-MAP charts are not automatically synchronized. C-MAP charts are only synchronized immediately after installing or updating the C-MAP database. If the system has several FCRs or FMDs, make a group of associated units before you install C-MAP charts.

7.20.1 How to select the units to synchronize

Do as follows to select the units to synchronize.

1. Get into the Chart maintenance mode. On the InstantAccess bar™, click [System] followed by [Sync Config] to show the [Sync Config] dialog box.



[Grouped with This Unit]: This window shows the units currently selected for synchronization.

[Not Synchronize with This Unit]: This windows shows the units not selected for synchronization.

2. **To select a unit for synchronization:** Put a checkmark next to the unit's name in the [Not Synchronize with This Unit] window then click the [<<] button. That unit's name is moved to the [Grouped with This Unit] window.
To deselect a unit from synchronization: Put a checkmark next to the unit's name in the [Grouped with This Unit] window then click the [>>] button. That unit's name is moved to the [Not Synchronize with This Unit] window.
 To deselect all units, click the [Reset All] button.
3. Click the [Save] button to finish.
4. Restart the power on applicable units to apply synchronization configuration changes.

7.20.2 How to check synchronization status

You can check chart synchronization status on the [Sync Status] dialog box. Chart synchronization operations also are available from this dialog box. Normally, chart synchronization is done automatically, according to the sync settings on the [Sync Config] dialog box. Use the [Sync Status] dialog box to manually synchronize chart data when there is network failure, for example.

Get into the Chart maintenance mode. On the InstantAccess bar™, click [System] followed by [Sync Status] to show the [Sync Status] dialog box.

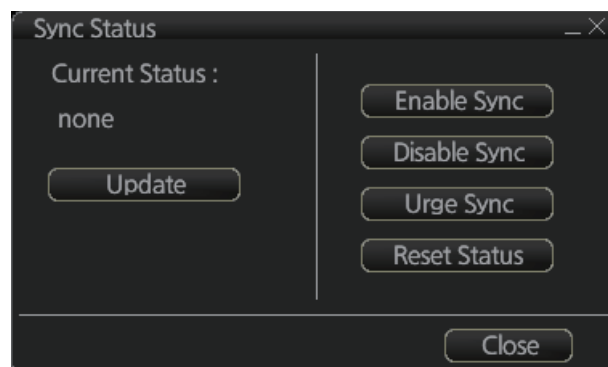

[Current Status]: Displays current synchronization status. The table below shows all the synchronization status messages.

Sync status	Meaning
[disabled]	Synchronization is disabled.
[must receive]	This chart radar will receive chart data from another FMD-3xx0, FCR-2xx9 or FAR-3xx0 series.
[must send]	This chart radar will send chart data to another FMD-3xx0, FCR-2xx9 or FAR-3xx0 series.
[none]	No synchronization task ready.

Note: Do not update charts manually when the sync status is “must receive”. Data may be corrupted. Wait until syncing is completed before updating charts manually.

[Update] button: Click this button to update [Current Status].

[Enable Sync] button: Enables synchronization. The confirmation message "Attention: Do you want to enable sync?" appears. Click the [OK] button to enable synchronization. Synchronization is always enabled when chart radar starts. A progress bar indicates progress in synchronization. The bar is erased within five minutes after completion of synchronization.

[Disable Sync] button: Disables synchronization function temporarily. Use this feature to enable chart administration in case of network failure, for example. The confirmation message "Attention: Do you want to disable sync?" appears. Click the [OK] button to temporarily disable synchronization.

Note 1: In normal operation do not disable synchronization. If you accidentally disable synchronization, try to synchronize by clicking the [Enable Sync] button. If that does not work, reset the power of all units selected for synchronization then click the [Urge Sync] button to synchronize.

Note 2: With synchronization disabled, the message "Synchronization disabled" may appear twice when installing a license. This does not affect installation of a license.

[Urge Sync] button: Does immediate synchronization. The confirmation message "Attention: Chart data in other units will be overwritten by this unit. Do you wish to continue?" appears. Click the [OK] button to synchronize. If synchronization is not successful, restart applicable units and try again.

[Reset Status] button: Reset synchronization status to recover from synchronization status conflict. The confirmation message "Attention: Do you want to reset sync status? This unit may be synchronized from the other unit." appears. Click the [OK] button to reset.

7.20.3 Manual updates and synchronization

If you are synchronizing multiple units (FMD-3x00, FCR-2xx9 or FAR-3xx0) while manual updating is being done on one of the units, the message "File not found" may appear, meaning the manual update data was deleted. If this occurs, follow the procedure below to synchronize the FAR-3xx0 units. The procedure uses CRA001 and CRA002 as an example.

1. At the CRA001, get into the Chart maintenance mode, then click [System] and [Sync Config] on the InstantAccess bar™.
2. Add CRA002 to [Grouped with This Unit] then click the [Save] button.

7. HOW TO MANAGE CHARTS

3. Reset the power on the CRA001 and CRA002.
4. At the CRA001, get into the Chart maintenance mode, then click the [System] and [Sync Status] buttons on InstantAccess bar™ to show the [Sync Status] dialog box.
5. Click the [Urge Sync] button to synchronize charts between CRA001 and CRA002.
6. To confirm synchronization, do as follows:
 - 1) At the CRA001, get into the Voyage navigation mode, then click the [Manual Update] button on the InstantAccess bar™ to open the [Manual Update] dialog box.
 - 2) Click the [Planning] tab followed by the [Add] button.
 - 3) Insert an object at the CRA001.
 - 4) At the CRA002, move the cursor or change the chart scale. Confirm that the chart is updated.

7.21 How to Reconvert All SENC Charts

If you unintentionally installed outdated SENC charts, you can reconvert those charts to the latest SENC charts. Click the [System] and [Reconvert] buttons on the InstantAccess bar™ to reconvert all your SENC charts.

Note: All manual updates are removed in the reversion.

7.22 How to Manage Gate-1 Charts

Gate-1 provides the ECDIS with the up-to-date UKHO chart data and permit file. To use Gate-1, the [Chart Service] setting must be set to [FURUNO], in the installation.

7.22.1 How to select the chart type(s) to install

1. Click the [CHARTS] button on the Status bar.
2. Click the [System] button on the InstantAccess bar™, then click [Gate-1 Config.] to show the [Gate-1 Config] window.

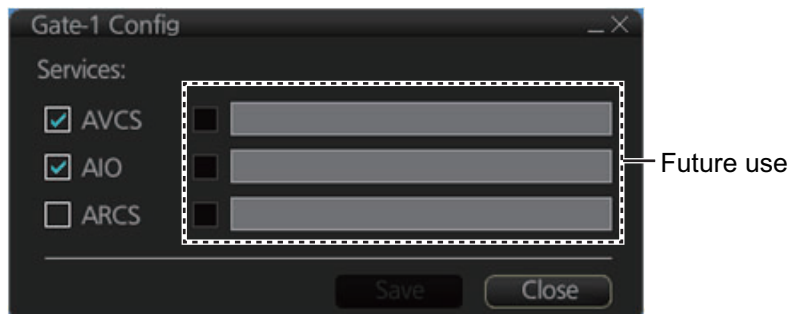

3. Check the chart type(s) that you want to install, then click the [Save] button.
4. You are asked if you are sure to save Gate-1 settings. Click the [OK] button to save settings. The message "Gate-1 services are saved. New services are applied after reboots." appears.
5. Click the [OK] button several times, then restart the unit.

7.22.2 How to install charts and licenses

To install the chart selected at section 7.22.1 and its license, click the [CHARTS] button on the Status bar, then click the [Gate-1] button on the on the InstantAccess bar™. The message "This process takes time to complete, and the operation speed of this system will decline. Do you wish to continue?" appears. Click the [OK] button to continue and install your charts.

7.22.3 How to order licenses

Follow the procedure below to order licenses from Gate-1.

1. Click the [Manage Charts] button to show the [Manage Charts] dialog box.

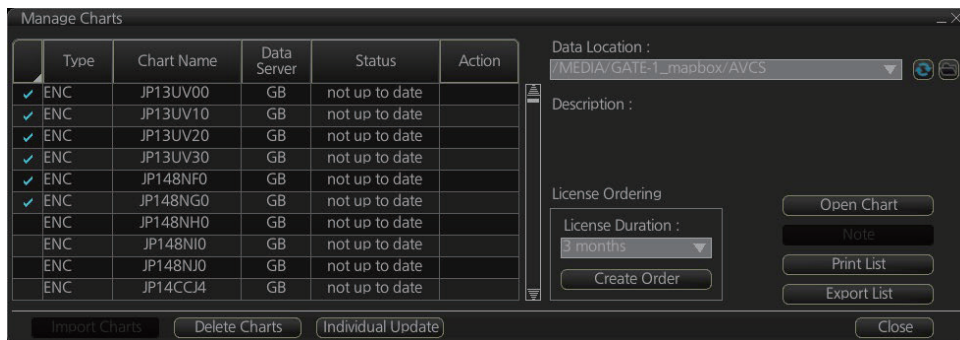

2. At the [License Ordering] window, select the license duration from the pull-down list.
3. Click an appropriate block in the far-left hand column to select the chart to order. Repeat to select other charts.
4. After selecting the chart(s) to order, click the [Create Order] button. A window shows the charts ordered together with total cost.

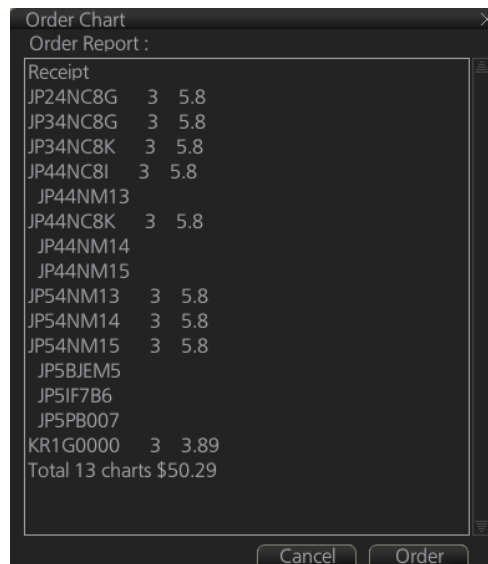

5. Confirm the licenses and prices, then click the [Order] button.

After completing the purchase operation, the chart license purchase procedure is done via Gate-1. It takes several hours for a new license to arrive at Gate-1.

Note 1: Once a purchase is made you cannot cancel the purchase. Take care when making your order.

Note 2: Only UKHO AVCS and AIO licenses can be purchased.

Note 3: A network communication usage fee is assessed when purchasing a license.

Note 4: Unselected cells may appear in the order window because of the AVCS sales format.

Note 5: When navigating a route with the chart filter on, the filter is applied to the region of the cell where a cell has not been purchased. A region does not always have actual data in all ranges.

7.23 How to Delete Chart Data

Converted data, license, and product list data can be deleted collectively as follows:

To clear all ENC data: Click the [CHARTS] button on the Status bar. On the Instant-Access bar™, click the [System], [Clear Charts] and [ENC] buttons.

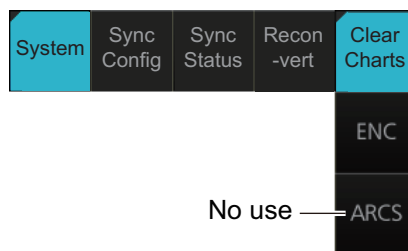

Note: For how to delete C-MAP data, see section 7.6.

8. HOW TO CONTROL CHART OBJECTS

This chapter provides the information necessary for controlling chart features.

8.1 How to Browse Your Charts

You can view your charts using different positions and different scales. The basic tools for browsing charts are the **RANGE** key, chart offcenter, and scroll.

RANGE - and **RANGE +** change the chart scale. (The scrollwheel also can change the chart scale. Spin to change.) If true motion reset is active, ZOOM IN and ZOOM OUT keep the relative position of your ship with respect to the display. If true motion reset is off, ZOOM IN and ZOOM OUT keep the relative position pointed by the cursor with respect to the display. The system automatically selects next larger or smaller scale. If a chart with larger compilation scale is available at your current viewing position, the message "Larger scale ENC available" appears.

The own ship position can be easily relocated to the screen center in the Navigation voyage and Navigation planning modes. Further, in the Navigation voyage mode, the own ship position can be put at the cursor position.

To move the own ship mark to the screen center, put the cursor in the chart area and right-click [Ship on center]. **To move the own ship mark to a location**, right-click the position on the chart where to put the own ship mark then right-click [Ship off center]. ([Ship off center] is not available in the Voyage planning mode.)

To scroll your chart, simply drag and drop.

8.2 How to Control Visibility of Chart Objects

The [Chart Display] menu has several pages of chart features that you may show or hide as appropriate. To display this menu, click the [DISP], [SET] and [Chart DISP] buttons on the InstantAccess bar™.

8.2.1 How to set value for shallow contour, safety depth, safety contour and deep contour

You can set values for shallow contour, safety depth, safety contour and deep contour, on the [Chart Alert] dialog box (sequence: [DISP], [SET], [Chart Alert]). Colors used for depth presentation on the electronic chart are controlled by setting values for shallow contour, safety depth, safety contour and deep contour. Soundings on the electronic chart, which are equal to or less than the value of safety depth, are highlighted. See the illustrations on the next page for multi-color presentation and two-color presentation. Selection of multi- and two-color presentations can be done with [Four Shades] on the [General] page of the [Chart Display] menu. Check the check box for multi-color; uncheck the box for two-color.

Note: The shallow contour cannot be set higher than the safety contour.

MULTI-COLOR presentation

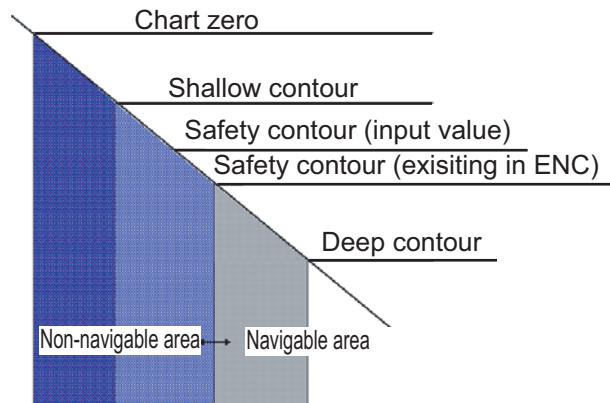

In the multi-color presentation four colors are used for depths. If the value entered as the safety contour does not exist in the electronic chart, the system automatically selects the next available deeper depth contour as the safety contour. For example, the input value is 8 m, but there is no 8 m depth contour in the electronic chart. Then, the system automatically selects the next available deeper depth contour (10 m) as the safety contour. The depth contour value of 10 m is used as the safety contour in the electronic chart.

Shallow contour shows visual color change inside an unsafe water area. An unsafe water area is all areas shallower than the safety contour. Set the value for the shallow contour less than the value of the safety contour.

TWO-COLOR presentation

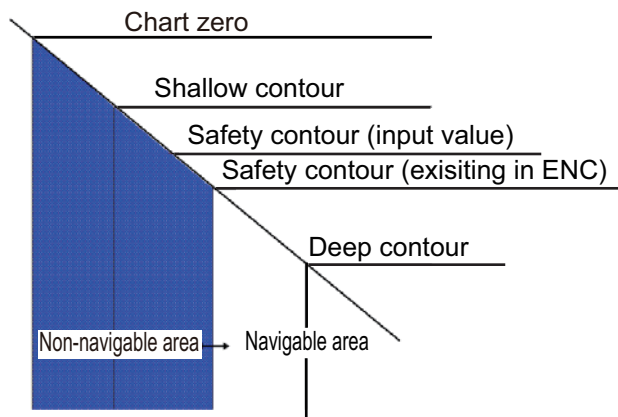

In the two-color presentation, unsafe water is shown in blue and safe water is shown in white. The safety contour is used to qualify unsafe water (depth shallower than safety contour) and safe water (depths deeper than safety contour).

If the value entered as the safety contour does not exist in the electronic chart, the system automatically selects the next deeper available depth contour as the safety contour, the same as with the multi-color presentation.

8.2.2 Basic Setting menu

To display this menu, click [DISP], [SET] and [Basic Setting] on the InstantAccess bar™.

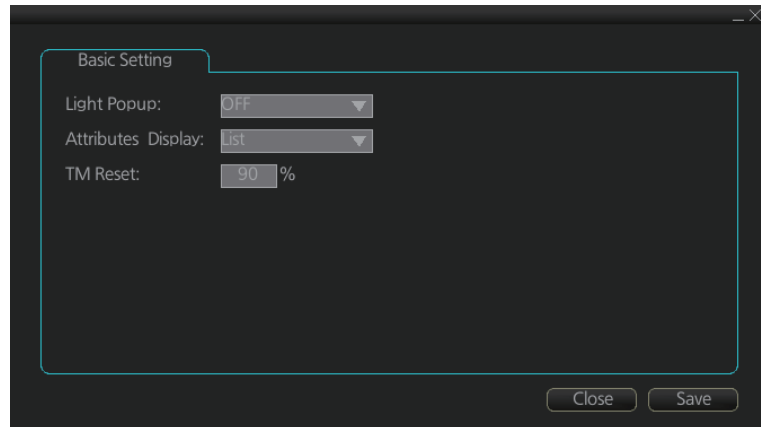

[Light Popup]: Show or hide light sectors information. [ON] provides light sector information (including length of arc of visibility) when the cursor is put on a light or light sector.

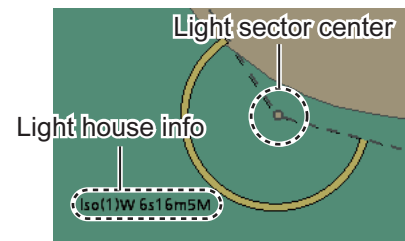

[Attributes Display]: Set how to show attributes in a Pick Report. The options are:

- [Text Box]

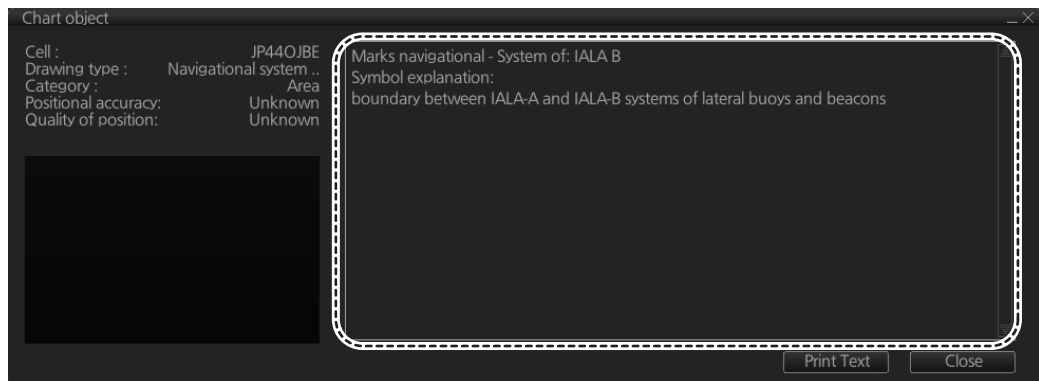

- [List]

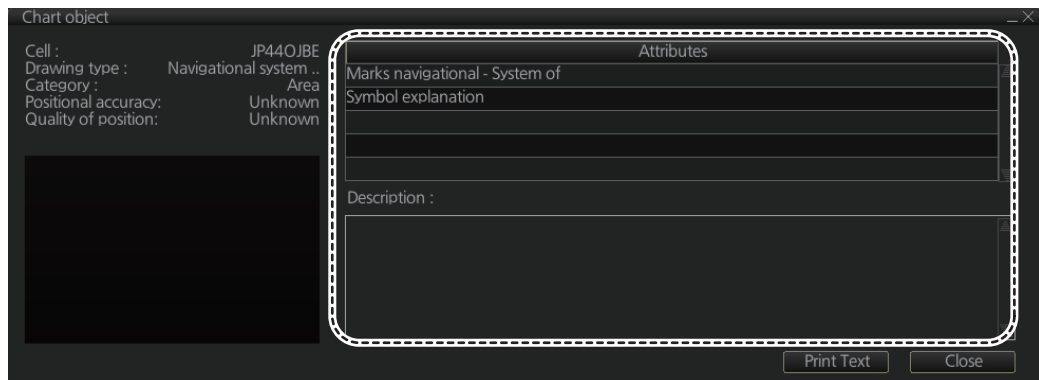

[TM Reset]: In the true motion mode, own ship moves until it reaches the true motion reset borderline (set here), and then it jumps back to an opposite position on screen based on its course. Set the limit for TM reset (in percentage). For example, "80" resets the position when the own ship marker is at a location which is 80% of the range.

8.2.3 Chart Display menu

To access the [Chart Display] menu and its pages, click [DISP], [SET] and [Chart?DISP] on the InstantAccess bar™. then select [General], [Standard], [Other], [Text], or [NtoM] page as appropriate.

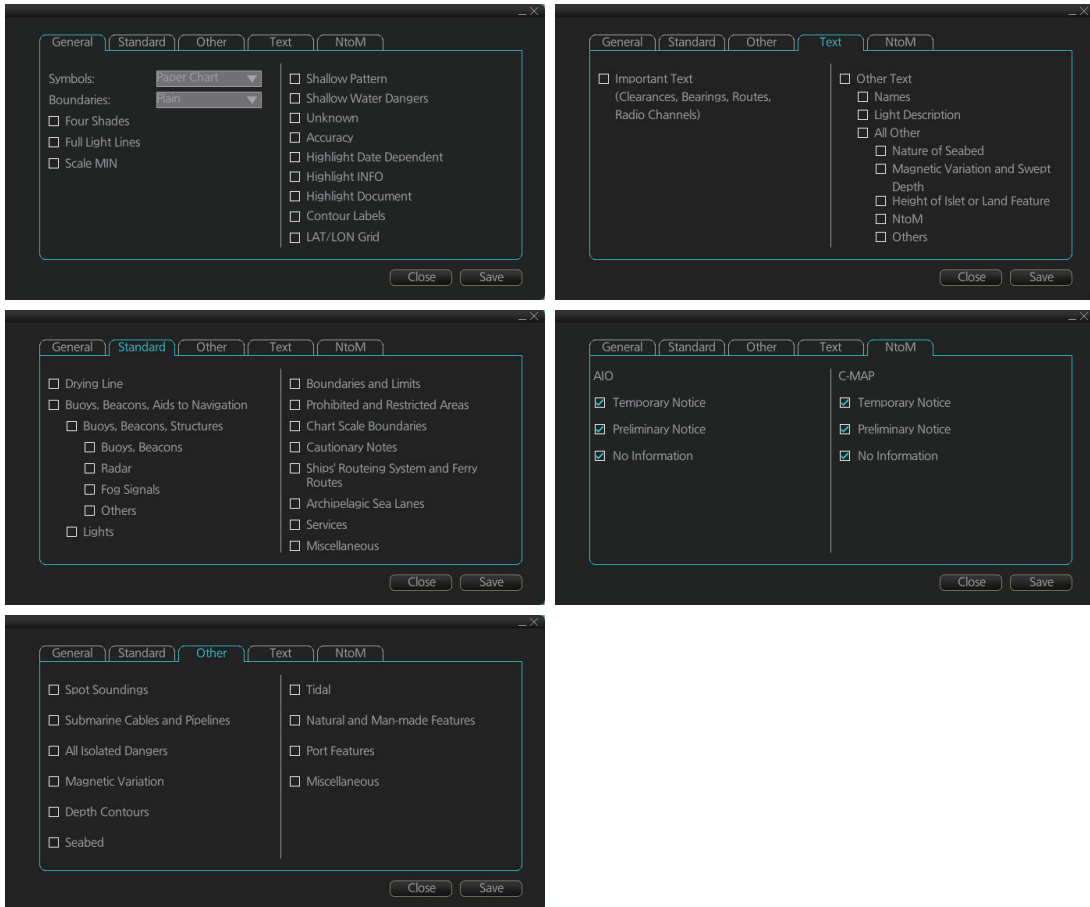

General page

This page turns chart features on (checkbox checked) or off.

Symbol: Determines how to display chart symbols.

- Paper Chart: Symbols displayed the same as the conventional paper chart symbols
- Simplified: Symbols displayed in simplified style, and the sea is displayed in color.

Boundaries: Determines how to show boundary lines of chart objects.

- Plain: Boundary line shown with solid and dashed lines.
- Symbolized: Symbol is attached to the line according to the purpose of the line.

Scale MIN: Set the minimum chart scale to display chart objects. When the chart scale is lower than set here, the chart objects will not be displayed.

Highlight Date Dependent: Put a highlight mark on the chart object which carries a date dependent attribute.

Highlight INFO, Highlight Document: Put a highlight mark on a chart object that has information or document attribute.

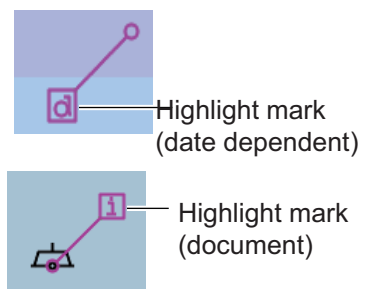

Standard page

The [Standard] page contains chart features defined by IMO that comprise a standard display.

Other page

The [Standard] page contains chart features not contained in IMO standard display.

Text page

Show or hide text information on the chart.

NtoM page

Show or hide the Notice to Mariners data.

Note: To use the “pick report” feature, which provides information for cursor-chosen chart feature, the associated chart feature must be turned on from the [General], [Standard], [Other], [Text], or [NtoM] page.

8.2.4 Display base

A subset of chart features is called the “display base”. As required by IMO, these features cannot be made invisible. To get the display base, click the [STD DISP] button on the status bar.

The display base consists of the following chart features:

- Coastline (high water)
- Own ship's safety contour, which is selected by the user
- Indication of isolated underwater dangers of depths less than the safety contour that lie within the safe waters defined by the safety contour
- Indication of isolated dangers that lie within the safe water defined by the safety contour such as bridges, overhead wires, etc., and including buoys and beacons whether or not these are being used as aids to navigation.
- Traffic routine systems
- Scale, range, orientation and operating mode
- Units of depth and height

8.3 How to Control Visibility of Symbols, Features

Control of symbols and features is divided into five pages in the [Symbol Display] menu, which you can access by clicking the [DISP], [SET] and [Symbol DISP] buttons on the InstantAccess bar™.

[General] page: Controls own ship and target related items.

[Tracking] page: Controls past tracks and some other features.

[Route] page: Controls planned and monitored route.

[Mariner] page: Controls user charts.

[Targets] page: Controls TT and AIS targets.

The user can define settings for chart details that are displayed over the chart area.

8.3.1 General page

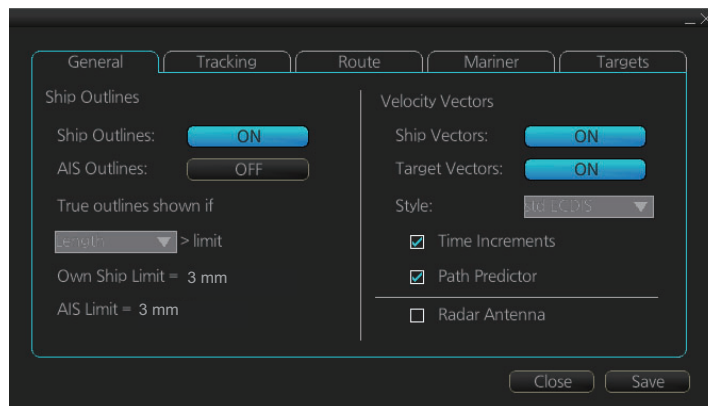

Ship, AIS Outlines

Ship Outlines: Select OFF or ON to show minimized or scaled symbol, respectively.

AIS Outlines: Select OFF or ON to show AIS targets in same size or scaled symbol, respectively.

True outlines shown if: If the length or width of the own ship mark is greater than 3.0 mm, the own ship mark is shown with the true scale symbol. Select [Length] or [Beam width].

The right illustration in the figure below shows own ship mark and AIS targets with scaled symbols. The left illustrations shows own ship mark and AIS targets with point symbols. AIS targets are displayed as true scale symbol if the displayed chart scale is larger than set with "Outlines" limit (length>3.0 mm) on the [General] page in the [Symbol Display] menu and your own ship are displayed as true symbol scale if the size of the true scale symbol is larger than 3.0 mm on the chart display.

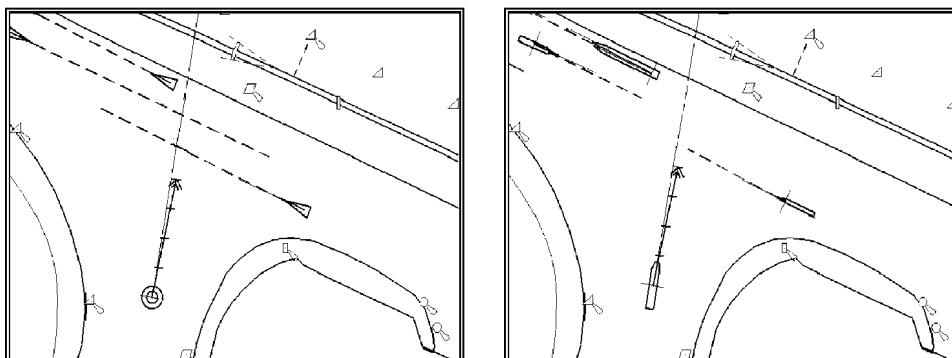

Velocity Vectors

Ship Vectors: Show or hide own ship vector.

Target Vectors: Show or hide target vectors.

Style: Select the vector style. The [std ECDIS] vector is a speed-referenced vector symbol. [Conventional] is a simplified symbol.

Time Increments: Check to show ticks of velocity vector. This controls both own ship and targets ticks. If ticks are too tightly spaced, they will be automatically removed from the display, until spacing between ticks is sufficient to distinguish them separately. This depends on display scale and speed of vessel and target.

Path Predictor: Check to show the path predictor. The path predictor is a single dashed line originating at the CCRP and drawn at a length to represent the distance and path own ship will travel over the ground in the user-selected time interval for own ship speed vector.

Radar Antenna: Check to mark position of radar antenna (with "x").

8.3.2 Tracking page

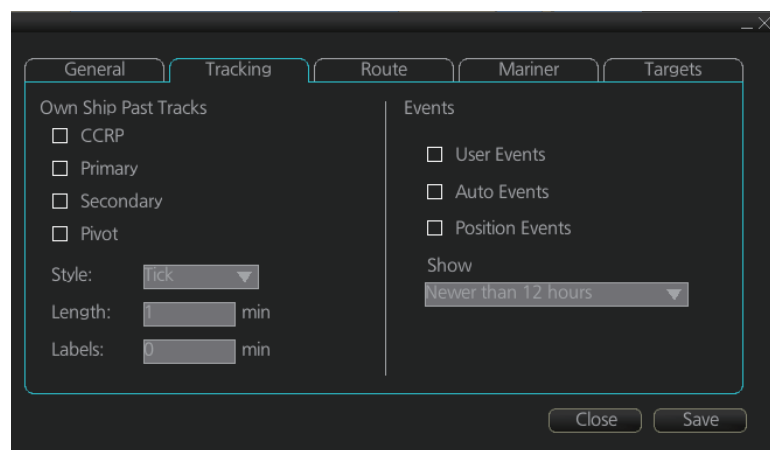

[Own Ship Past Tracks]

CCRP: Check to plot own ship's track with CCRP position as reference.

Primary: Check to plot own ship's track with position fed from sensor with highest priority.

Secondary: Check to plot own ship's track with position fed from sensor with 2nd highest priority.

Pivot: Check to plot own ship's track with own ship's pivot position as reference.

Style: Select time stamp position for past track (indicated by Tick or Point).

Length: Select length of past track.

Labels: Select label interval.

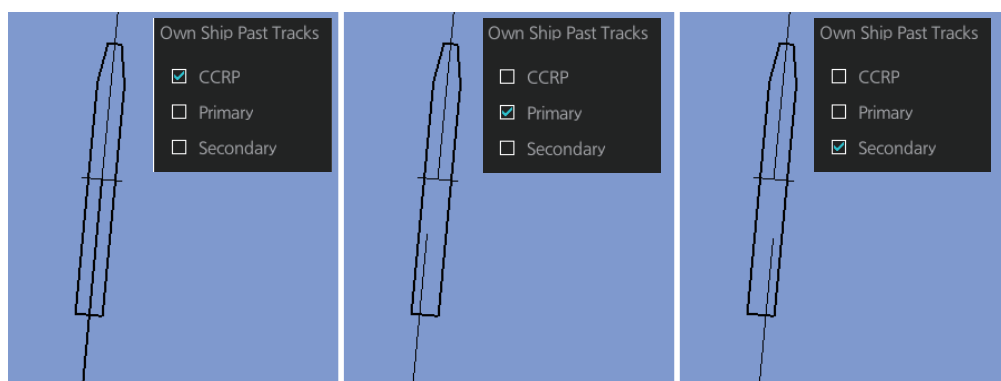

[Events]

Events marks are based on the [Voyage] log records.

User Events: Display event symbols on the chart. User events are recorded by clicking [Log], [Event Log] and [User Event] on the InstantAccess bar™.

Auto Events: Display automatically entered event symbols, where the system has recorded an event based on conditions you have set. The available recording interval is 1 to 4 hours.

Position Events: Display the latitude and longitude of an event, recorded by clicking [Log], [Event Log] and [POSN Event] on the InstantAccess bar™.

Note 1: A MOB event is visible always.

Note 2: You can select the period of time to display event marks, from the [Show] list box. [Newer than 12 hours], [Newer than 24 hours], [Newer than 1 week], [Newer than 2 weeks], [Newer than 1 month], [Newer than 3 months], or [All].

8.3.3 Route page

The [Route] page selects the route parts of the monitored and planned routes to show on the chart.

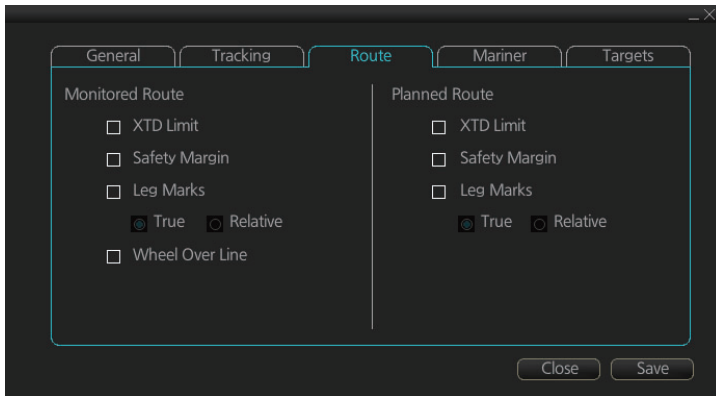

[XTD Limit]: The distance from the centerline to one side of the nav lane.

[Safety Margin]: The distance from one side of the channel limit to the safety margin distance.

[Leg Marks]: Indications of waypoint no. and range and bearing to next waypoint. ([True]: Reference to North; [Relative]: Reference to heading)

[Wheel Over Line]: The location where the ship turns toward new course.

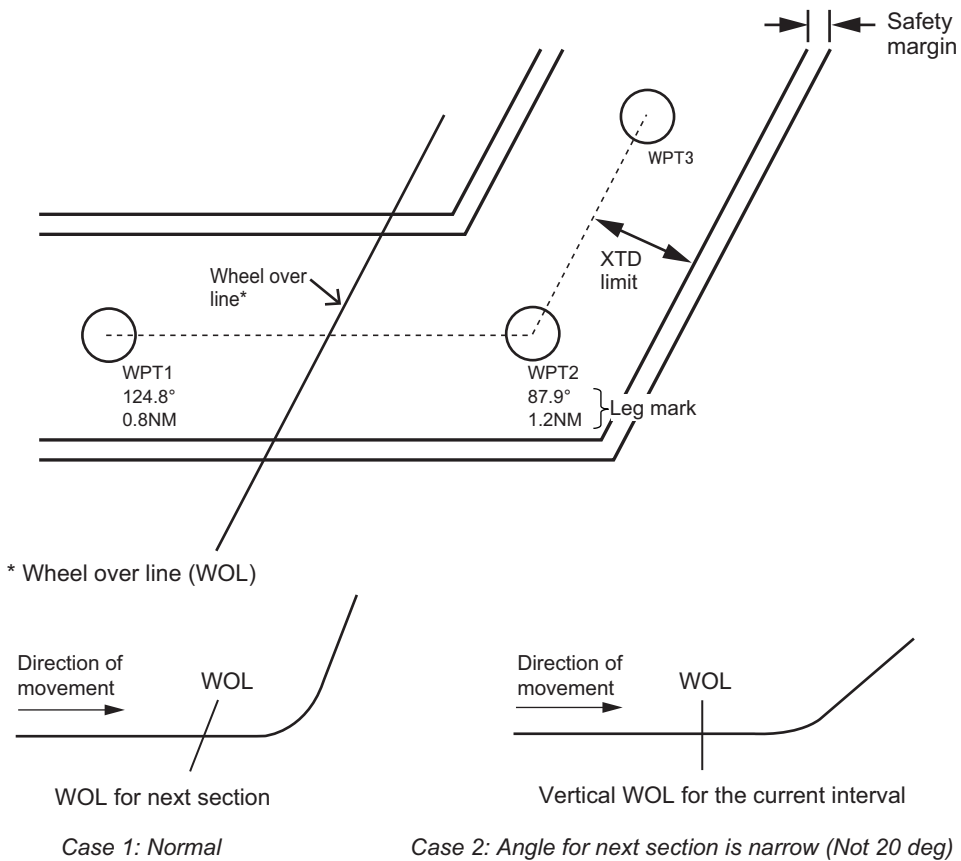

8.3.4 Mariner page

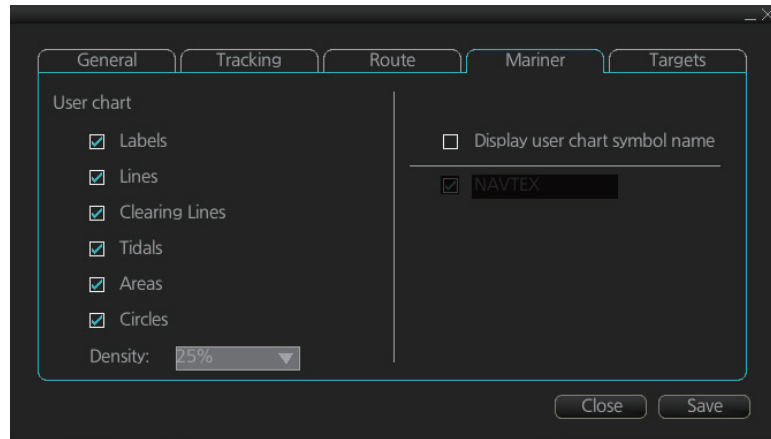

[User chart]

[Labels]: Check to show labels on user charts.

[Lines]: Check to show lines on user charts.

[Clearing Lines]: Check to show clearing lines (for marking dangerous areas) on user charts.

[Tidal]: Check to show symbols and tides on user charts.

[Areas]: Check to show areas on the user charts.

[Circles]: Check to show circles on user charts.

[Density]: Set the degree of transparency for the user chart objects. Color fill for the areas can be selected as transparent from 25%, 50%, 75% and as [No color fill]. If [No color fill] is selected, only the boundaries of the areas are visible.

[Display user chart symbol name]: Check to display the name entered for a user chart symbol in the [Name] column of the [User Chart] dialog box. Effective for the circle and area symbols only. Names are shown in both the Voyage planning and Voyage navigation modes. See the figure below for examples.

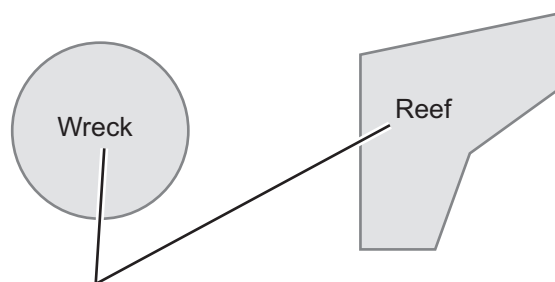

Name as entered in [Name] column.

[NAVTEX]: Available only when a Navtex receiver is enabled at installation. Check to put the Navtex symbol () at the coordinates received in a Navtex message. Depending on the information received, the symbols appears as shown in the figure on the following page.

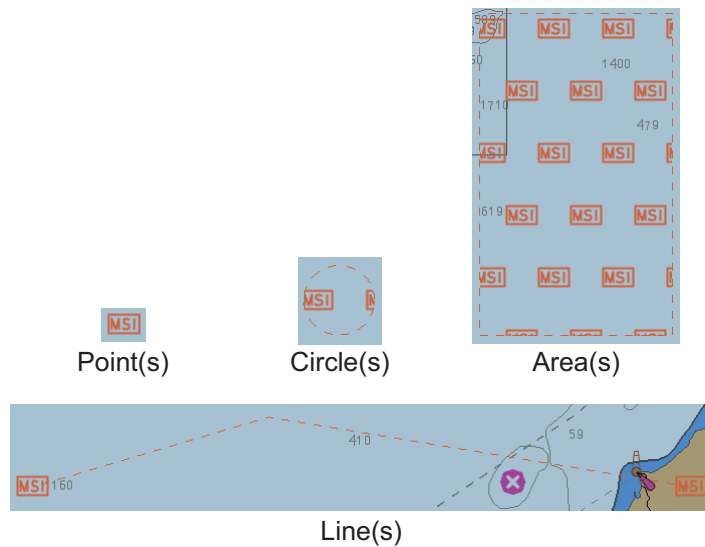

Right-click the [MS1] mark to show the context-sensitive menu, then click [NAVTEX MSG] to show the [NAVTEX] page of the Message dialog box (see section 17.2.1).

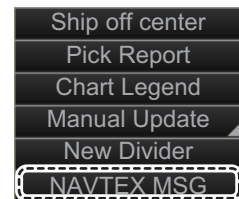

8.3.5 Targets page

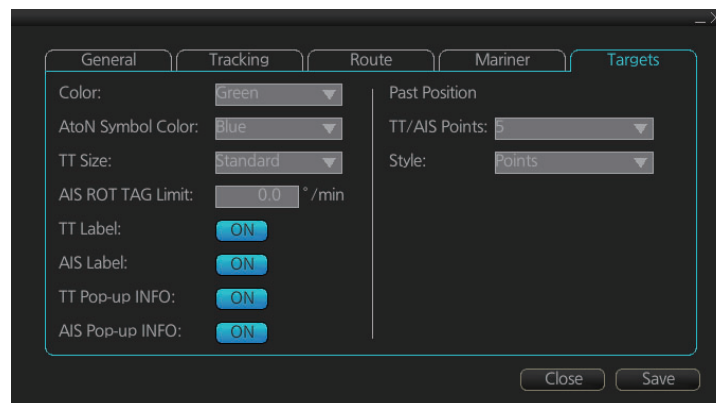

- [Color]: Select color of target (TT and AIS, common) from the list box.
- [AtoN Symbol Color]: Select the color for AtoN symbols.
- [TT Size]: Select symbol size for tracked targets, [Standard] or [Small].
- [AIS ROT TAG Limit]: ROT (°/min.), limit to display AIS target with curved speed vector. (Source of ROT must be ROT gyro on target vessel.)
- [TT Label]: Show or hide the TT label (target no.).
- [AIS Label]: Show or hide the AIS label (ship's name).
- [TT Pop-up INFO]: Show or hide the TT pop-up, which is shown by placing the cursor on a TT.
- [AIS Pop-up INFO]: Show or hide the AIS pop-up, which is shown by placing the cursor on an AIS target.

TT pop-up info

```

TT(04)
COG: 235.0°T
SOG: 6.1kn
CPA: 0.23NM
TCPA: -10:18
  
```

AIS pop-up info

```

AIS_CLASS...
COG: 324.0°T
SOG: 8.1kn
CPA: 0.12NM
TCPA: -19:18
  
```

[Past Position]

- [TT/AIS Points]: Select the number of TT/AIS past position points to display.
- [Style]: Select style of presentation of target's past position.

8.4 Control of Predefined IMO Chart Display Settings

There are three sets of predefined chart display settings that can be used to display charts with certain chart features. The predefined chart display settings are

- [IMO BASE]
- [IMO STD] (STANDARD)
- [IMO ALL]

When the chart settings are changed, the following settings changes are also applied to each page of the [Chart Display] menu.

	[Chart Display] menu		
	IMO Base	IMO Standard	IMO All
[Standard] page	All items are unchecked.	All items are checked.	All items are checked.
[General] page	All items are unchecked.	All items are unchecked.	All items are unchecked.
[Other] page	All items are unchecked.	All items are unchecked.	All items are checked.
[Text] page	All items are unchecked.	All items are unchecked.	All items are checked.
[NtoM] page	All items are checked.	All items are checked.	All items are checked.

You can change the chart display setting in use with the [Chart database] button on the Status bar.

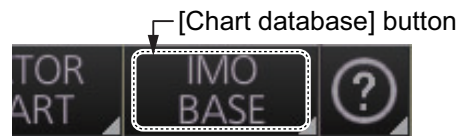

9. VECTOR (S57) CHARTS

Theoretically a chart can be coded for use on a computer as a vector chart. Vector-coded charts are coded using a variety of techniques. One technique is called S57ed3 and it has been chosen by IMO as the only alternative for SOLAS compliant electronic charts. If an S57ed3-coded chart is published by a government-authorized Hydrographic Office, then it is called "ENC". You can read more about ENC and related legal issues in this chapter. Hereafter, all references to vector chart material are referred to as "S57 charts" regardless of their source.

Sometimes you may wish to manually add Notices to Mariners or Navtex warnings into your S57 charts. This is called "manual updates". Also, manual updates are valid for all scales so that you don't need to repeat them for charts published in different scales from the same area.

9.1 Introduction to S57 Charts

An ENC chart is encrypted to prevent unauthorized use so the user needs a permit to view the ENC. This permit could be entered manually from the Control Unit, loaded from a USB flash memory.

Any new ENC must be loaded into the system. Some parts of the charts may be date dependent, i.e., they are visible after a set date or they are visible only for a limited period, etc. In the electronic chart system, you control all date-dependent objects with Display date and Update Review dates (see section 9.2.2 for how to set these dates). In the paper chart world, the Preliminary and Temporary Notices to Mariners represent the date dependency described above for S57 charts.

An important part of ENCs are the updates. Hydrographic Offices can issue two kinds of updates:

1. Incremental updates, which are small additions to original base cells.
2. Reissues and new editions, which are complete replacements of previous base cells and their updates.

All updates are date stamped and they may also contain date-dependent parts. You control usage of updates in the electronic chart system from Display date and Update Review dates. Using Display date and Update Review dates, you can view your charts correctly drawn on any date in the past or in the future.

Chart material will be stored in media such as DVD ROMs, CD ROMs and USB flash memory or electronically through from LAN (Local Area Network) in which it could have arrived in DVD ROMs, CD ROMs or USB flash memories. Such material can contain only basic cells, cells and updates or only updates. The electronic chart system contains as standard the software required to access a medium.

Each S57 chart may contain additional links to textual descriptions or pictures, besides the chart itself. Typically additional textual descriptions and pictures contain important sailing directions, tidal tables and other traditional paper chart features that do not have any other method to be included into the S57 chart. This system copies these textual descriptions and pictures into its SSD so the user may cursor-pick them for viewing purposes.

9.1.1 Definitions of terms

Cell	A cell is a geographical area containing ENC data and it is the smallest division of ENC data. Each cell has a separate unique name. Hydrographic Offices divide their responsibility area by the cells that they publish.
S57 chart	A database, standardized as to content, structure and format, is issued for use with this system without any authority of government-authorized Hydrographic Office.
ENC	A database, standardized as to content, structure and format, is issued for use with this system on the authority of government-authorized Hydrographic Offices. The ENC contains all the chart information necessary for safe navigation and may contain supplementary information in addition to that contained in the paper chart (e.g., sailing directions) that may be considered necessary for safe navigation. The name of the coding standard for ENC is S57ed3.
SENC	A database resulting from the transformation of the ENC by the system for appropriate use, updates to the ENC by appropriate means, and other data added by the mariner. It is this database that is actually accessed by the system for display and other navigational functions. The SENC may also contain information from other sources.

9.1.2 Chart legend for S57 charts

[Chart Legend] dialog box provides various information about the ENC chart currently displayed. The information can be displayed two ways:

- **Chart data for own ship position:** Right click the chart area, select [Ship on center] from the context menu, then click [Chart INFO] and [Chart Legend] on the Instant-Access bar™.
- **Chart data for cursor position:** Right click the chart area, select [Ship off center] from the context menu, then click [Chart INFO] and [Chart Legend] on the Instant-Access bar™.

To close the dialog box, click the [Close] button.

This system is capable of showing more than one S57 chart at a time. This feature is called the multi-chart display. If one S57 chart does not cover the whole display, the system will open more S57 chart cells for display, if appropriate cells for the displayed area are available. The chart legend shows information about S57 charts displayed on the electronic chart display area.

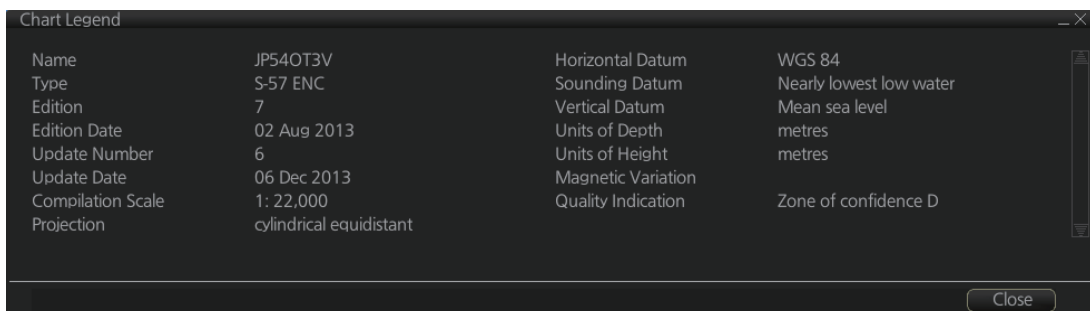

[Name]: Name of chart.

[Type]: Type of chart.

[Edition]: Edition number of the chart.

[Edition Date]: Date the edition was published.

[Update Number]: Update number.

[Update Date]: Date of update.

[Compilation Scale]: The scale of the original paper chart is shown here.

[Projection]: Projection of current chart.

[Horizontal Datum]: Horizontal datum used with current chart.

[Sounding Datum]: Datum used to create sounding data.

[Vertical Datum]: Vertical datum used with current chart.

[Units of Depth]: Unit of depth used with current chart.

[Units of Height]: Unit of measurement used to measure height of objects above sea level.

[Magnetic Variation]: Amount of magnetic variation. A positive value indicates a change in an easterly direction and a negative value indicates a change in a westerly direction.

[Quality Indication]: Quantitative estimate of the accuracy of chart features, given by the chart producer.

9.1.3 Permanent warnings for S57 charts

Permanent warnings help you keep the installed S57 charts up-to-date and these are shown at the bottom of the screen. Permanent warnings appear if the system detects a condition that may cause a chart to be not up-to-date.

Message	Meaning, Remedy
Display Not Real Time	Display date is not the current date. Set Display date and Update Review date to the current date.
No connection to dongle	The dongle is not inserted or not recognized. Insert the dongle to erase the message.
Not up to date (SSE 27): XXXXXXXX (Chart name appears at location of Xs.)	At least one chart is not up to date. Load updated material.
Permit expired (SSE 25): XXXXXXXX (Chart name appears at location of Xs.)	You have an expired permit for a chart. Remove the chart or renew subscription for the permit.

Note: The system can assist in keeping RENC-received charts up-to-date. For charts that have been loaded from sources other than an RENC, the system is unable to know the exact up-to-date situation.

9.2 Chart Viewing Dates and Seasonal Features of the S57 Chart

9.2.1 Introduction

S57 charts contain date-dependent features. Updating in general, including reissues, new editions and updates, creates date dependency. In addition to the obvious date dependency, some features of the S57 charts create additional date dependency. These features include "Date Start", "Date End", "Seasonal date start" and "Seasonal date end". Hydrographic Offices use these features to publish Temporary and Preliminary Notices to Mariners, as their paper chart equivalent updates are called. "Seasonal date start" and "Seasonal date end" are used for seasonal chart features such as summer-only sea marks, seasonal yacht race areas, etc.

You can efficiently use chart viewing date dependency in order to use the valid data for any given date applicable for your navigation or planning purposes. For example, you can check for existence of changes and restrictions weeks before they became valid. Date dependency is a part of the new electronic method to keep your chart up-to-date and valid for your intended use. Normally you should set Display date and Update Review once per week to keep your chart up-to-date.

9.2.2 How to set Display date and Update Review dates

1. On the InstantAccess bar™, click the [Chart INFO] and [Viewing Dates] button. The [Viewing Date] dialog box appears.

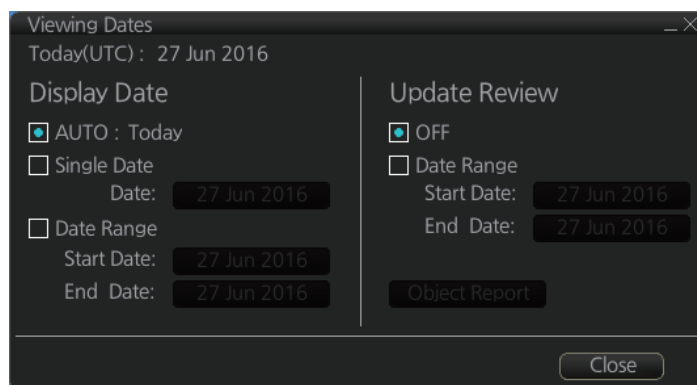

2. Select either [Single Date] or [Date Range] from the [Display Date] column, as appropriate. The date button becomes active and selectable, as shown in the example figure below.

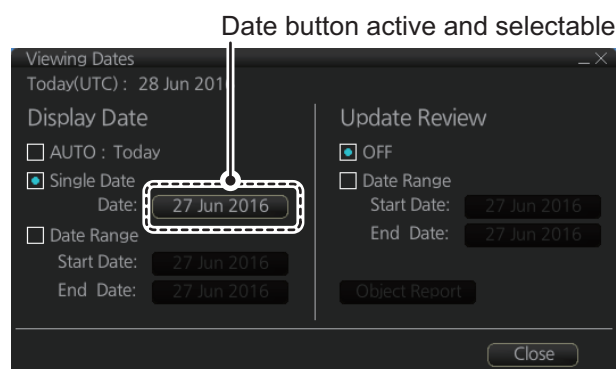

- [Single Date]: Display only charts which have this date.

- [Date Range]: Display all charts within the set range.
3. Click the date button to show the [Set date] dialog box.
 4. Select the appropriate date from the calendar, then click [OK] to close the [Set date] dialog box and return to the [Viewing Dates] dialog box.
 5. Click [Close].
 6. Check the appropriate charts, then access the Viewing Dates dialog again (see step 1).
 7. Select [AUTO - Today] to show the current date's chart.
 8. Click [Close].

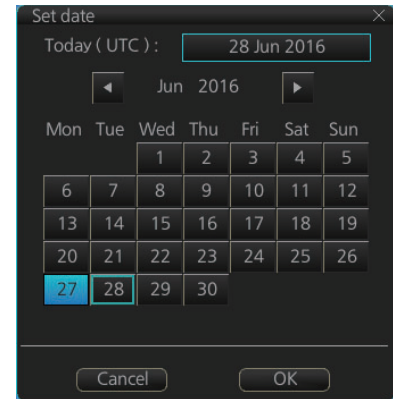

9.2.3 About chart viewing date dependency of S57 standard

How the issue date of updates changes the visibility of the changes

Study the example below to understand the behavior of updates relative to date.

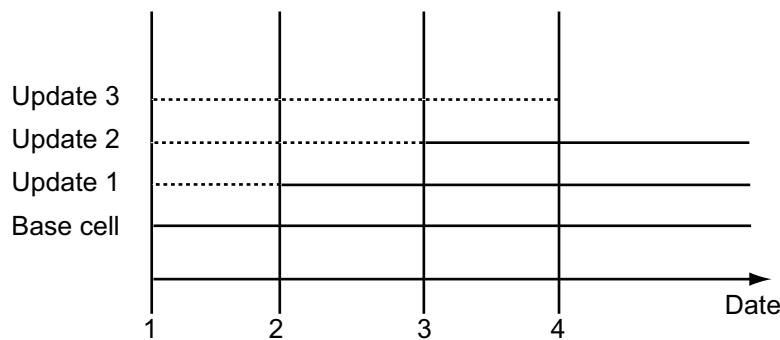

The figure above shows how updates are dependent Chart viewing dates set in Display/Update Review date settings by user. Actions 1 to 4 are as follows:

1. Base cell including three updates is converted into SENC. Display Date is set as current date of the system.
2. The date in which update 1 was issued. [Display Date] must be set to correct date in order to see the chart with update 1.
3. The date in which update 2 was issued. [Display Date] must be set to correct date in order to see the chart with update 1 and update 2.
4. The date in which update 3 was issued. [Display Date] must be set to correct date in order to see the chart with update 1, update 2 and update 3.

Note 1: In order to display charts with correct updated situation, always use current date during your voyage. If your voyage lasts more than one week, set current date at least once per week during your voyage.

Note 2: In order to display charts with correct updated situation during route planning, always use planned date of each waypoint to check your plan.

9.2.4 How to approve and highlight S57 chart updates

You can highlight updated data by setting a date (or date period) and creating a report.

1. On the InstantAccess bar™, click the [Chart INFO] and [Viewing Dates] button. The [Viewing Date] dialog box appears.
2. In the [Update Review] column, check the [Date Range] box. The [Start Date] and [End Date] buttons become active and selectable.

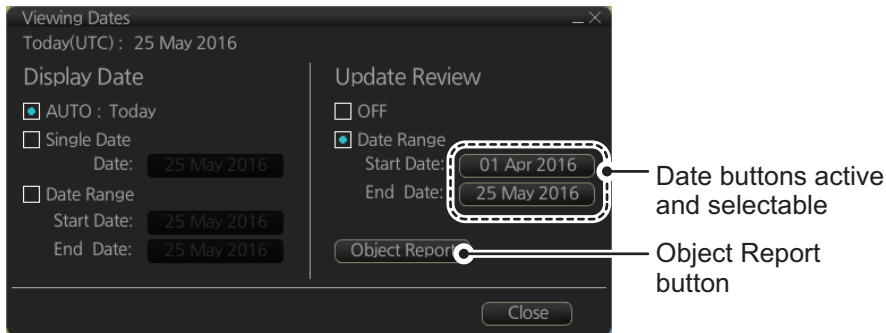

3. Click the [Start Date] button to show the [Set date] dialog box.
4. Select the start date, then click [OK].
5. Click the [End Date] button to show the [Set date] dialog box.
6. Select the end date, then click [OK].
7. Click [Object Report]. The [Object Update Review] dialog appears.

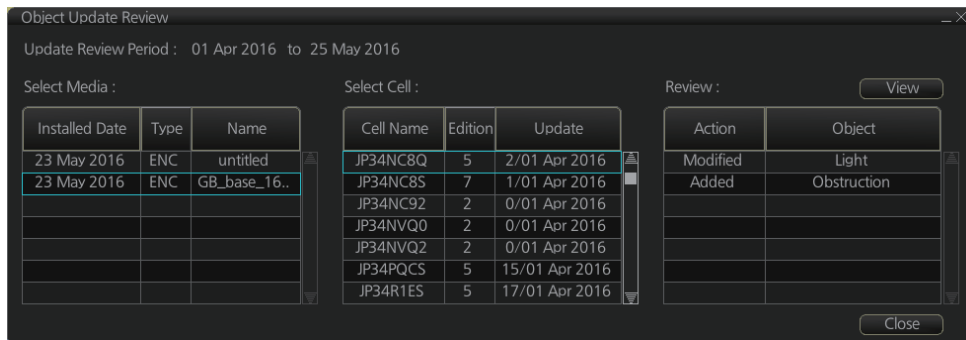

8. Select the items to highlight, then click the [View] button. Items selected here appear with an orange highlight mark.
9. To remove highlights, set the [Update Review] column of the [Viewing Dates] dialog box to [OFF].
10. Click the [Close] button on the [Viewing Dates] dialog box to close the dialog boxes.

9.3 Symbology Used in S57 Charts

You can familiarize yourself with the symbology used by browsing IHO Chart 1, which is included in this system. Note that it behaves as any S57 chart and it follows your selections. See section 8.2.

1. Click the [Chart INFO] and [Chart 1] buttons on the InstantAccess bar™ to show to the [ECDIS Chart 1] menu, shown below.
2. Click a chart feature to show detailed information about the feature. Click [Overview] to show a compilation of all features, shown below.

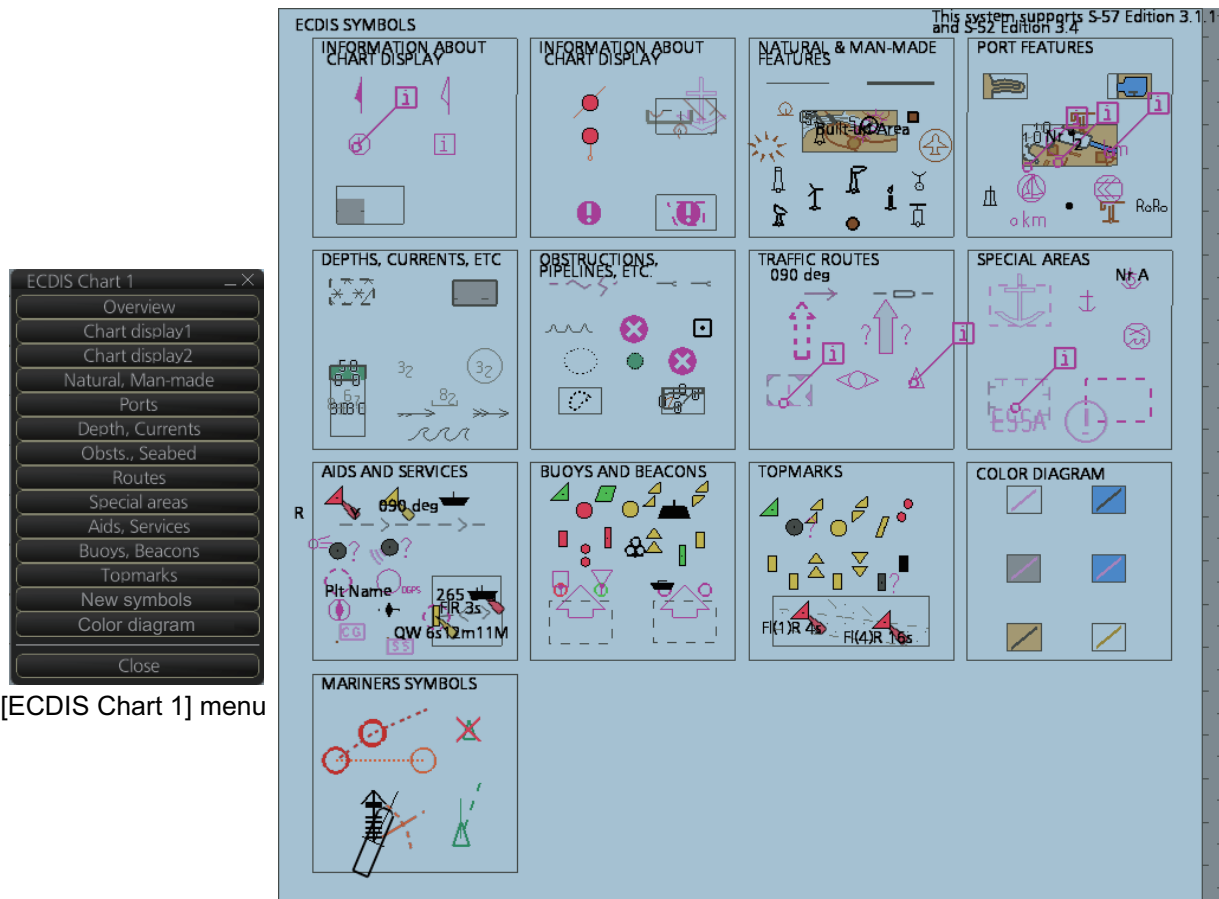

9.3.1 Presentation library used for S57 chart features

The system uses the official IHO presentation library to draw S57 charts. The presentation library is replaceable, but this feature is only intended to be used by qualified service personnel and type approval authorities.

When this manual was published the official presentation library was "pslb04_0.dai", known as "Official IHO presentation library for system Ed 4".

9.4 How to Find Information About S57 Chart Objects

The ability to cursor-pick an object to find additional information about the object is an important function of the system. However, an unprocessed cursor pick, which does not discriminate or interpret and merely dumps on the interface panel all the information available at that point on the display, will normally result in pages of unsorted and barely intelligible attribute information.

Do the following to find information about a chart object.

1. Get into the Voyage navigation mode or Voyage planning mode then right-click an object to show the context-sensitive menu.

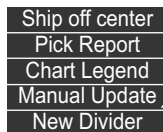

2. Click [Pick Report] to show the [Select Object] dialog box.

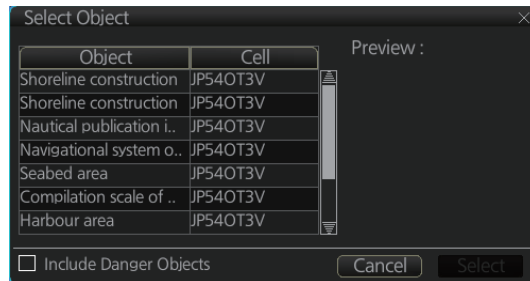

Note: The [Include Danger Objects] check box appears when there is at least one dangerous object. To show dangerous objects in the [Select Object] dialog box, check this box (after the box is checked it becomes unselectable).

3. Click the object for which you want to know its details then click the [Select] button.

Note: Objects selected from the Select Object dialog box are highlighted in orange color and are shown with a broken box (☒).

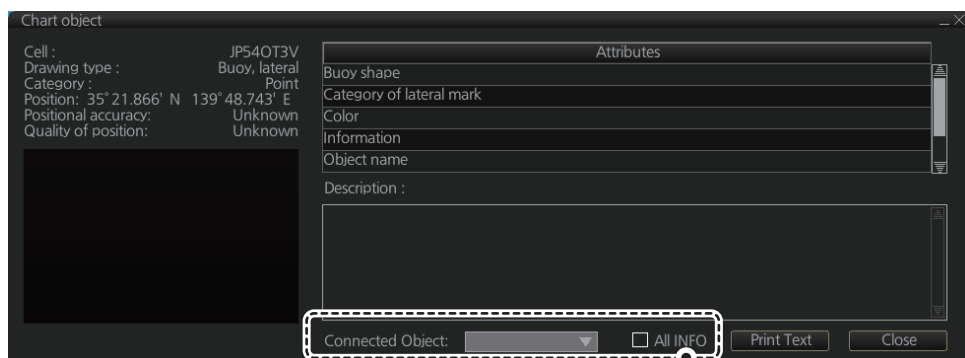

Depending on the item selected, these indications may be hidden.

- [Description] window: Click an attribute to view its description in this box.
- [All INFO]: Check the [All INFO] box to show all information in the [Attributes] window. (The [All INFO] box becomes unselectable when checked.)
- [Connected Object]: Objects which are connected to the selected object are shown in the drop-down list. Select an object from the list to show its details.

Note 1: If another window is active, the preview window may be partially obscured by that window. Move the window to display the entire preview.

Note 2: The [Attributes] window of the [Chart Object] dialog box changes according to the settings for [Attribute Display] in the [Basic Settings] menu (see section 8.2.2).

9.5 Admiralty Information Overlay (AIO)

The Admiralty Information Overlay includes all Admiralty Temporary and Preliminary Notices to Mariners (T&P NMs) and provides additional navigationally significant information from UKHO's ENC validation programme. The AIO is displayed as a single layer on top of the basic ENC and is available free of charge as part of the Admiralty S57 Chart Service and within Admiralty Value Added Resellers' services.

The AIO has been developed to ensure mariners can simply view the information they need - in addition to the standard chart - to navigate safely and compliantly. By clearly showing where important Temporary or Preliminary changes may impact a voyage, the Admiralty Information Overlay will give seafarers the same consistent picture of the maritime environment on their charts as they have always had.

The AIO license is free of charge for AVCS license holders.

9.5.1 Installation

Installation is the same as that for the ENC chart. See section 7.2.

9.5.2 How to display the AIO

Click the [DISP], [NtoM] and [ALL] buttons to show the AIO. To hide the AIO, click the [DISP], [NtoM] and [OFF] buttons.

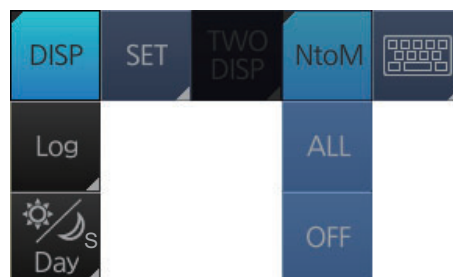

The area(s) that contain temporary or preliminary changes are marked with a hatched red rectangle.

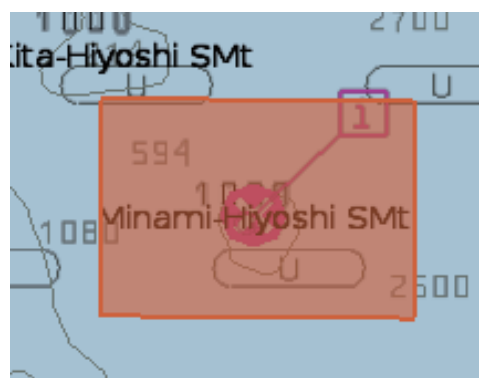

9.5.3 Catalog of AIO cells

A catalog of AIO cells is maintained in the [Manage Charts] dialog box. To show this box, get into the Chart maintenance mode then click the [Manage Charts] button on the InstantAccess bar™. The AIO cell is GB800001.

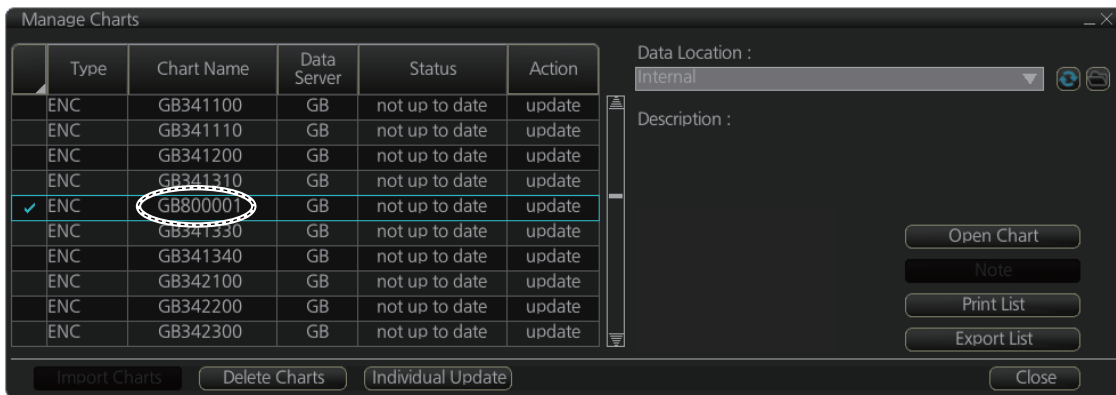

9.5.4 How to find AIO chart object information

Do the following to find chart object information contained in the AIO.

1. Right click a red hatched area in the chart area, then select [Pick Report] to show the [Select Object] dialog box.

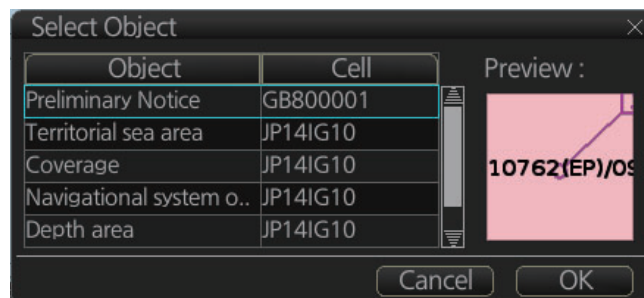

2. Click [Preliminary Notice] in the dialog box to show the [Chart object] dialog box.

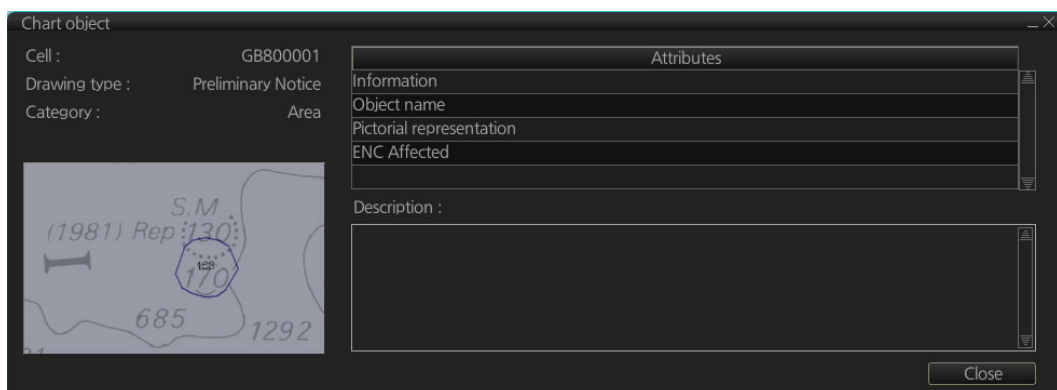

The [Chart object] dialog box shows the following information:

- Cell (name)
- Drawing type (Preliminary Notice, Temporary Notice)
- Category (AIO)
- Positional accuracy
- Quality of position

- The preview box provides a scaled-down image of the area selected. Click the image to enlarge it.
- The [Attribute] window shows the attributes for the AIO area selected. To find information about an attribute, click it to show its information in the [Description] box.
 - Information:** Description of area (for example, danger area).
 - Object name:** Object name (number)
 - Textual description:** Full text of the Notice to Mariners (NtoM)
 - ENC affected:** ENC affected by the NtoM
 - Included in updates:** Date this item was updated ([Preliminary Notice] items only)
- [All INFO] checkbox: Check the box to show [Source indication] at the bottom of the [Attribute] window. (The [All INFO] box becomes unselectable when checked.)

Note: The [Attributes] window of the [Chart Object] dialog box changes according to the settings for [Attributes Display] in the [Basic Settings] menu (see section 8.2.2).

9.5.5 How to select the information to display

Select what type of notices to display as follows:

1. Click the [DISP], [SET] and [Chart DISP] buttons on the InstantAccess bar™.
2. Click the [NtoM] tab.

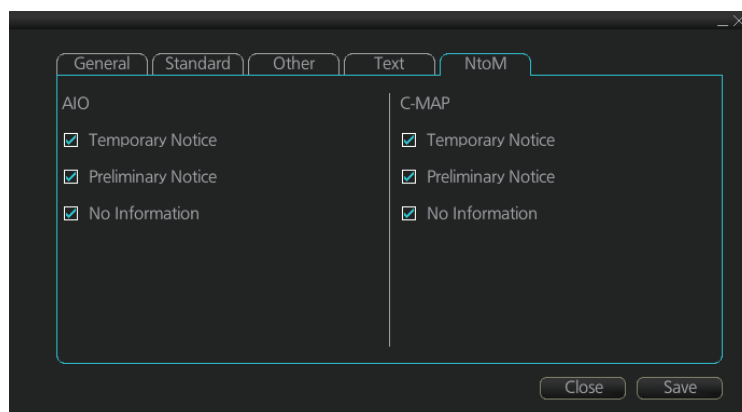

3. In the [AIO] window, check or uncheck items as appropriate.
4. Click the [Save] button to save settings then click the [Close] button to close the menu.

9. VECTOR (S57) CHARTS

This page is intentionally left blank.

10. C-MAP CHARTS

Your chart system has the capability of using and displaying the latest C-MAP world-wide vector chart database. These charts are fully compliant with the latest IHO S-57 3.1 specifications.

In order to prepare the system for use with the C-MAP database, there are a number of things that must be done.

The descriptions in this chapter apply to the C-MAP charts. (This system does not support CM-93/2 charts.)

10.1 How to Register the System at C-MAP

Your system has the capability to use the C-MAP database. To do so an eToken (supplied by C-MAP) must be connected to the system. The eToken provides the system with a unique System ID that enables C-MAP to issue correct licenses. The actual System ID can be found on the eToken itself, on the back of the installation CD box or on a sticker placed on the equipment. This ID must be provided on all chart orders, by e-mail (license.marine@c-map.com).

10.2 How to Order Charts

A chart order may be sent together with system registration as described above. It is essential that the required information be sent to C-MAP when ordering charts for a system. C-MAP issues order forms specifying the information that is required, and contains vital information that will allow C-MAP to monitor and maintain your licenses throughout the lifetime of the system.

For details on how to order charts see the C-MAP official website (<http://www.c-map.com/>).

10.3 How to Apply for Licenses

Once the order has been received at C-MAP, a license will be generated and transmitted back to the operator. This may be in the form of a single alphanumeric string (16 characters), or in the form of a file called PASSWORD.USR. Once this license has been received it should be input using the License Administrator software designed and supplied by the chart manufacturer. There are two types of licenses, purchase and subscription. Purchase licenses are valid indefinitely while subscription licenses need to be renewed every 12 months from the start of the subscription. Failure to renew a subscription will result in the charts becoming unavailable.

10.4 Troubleshooting

If you are having problems installing your software or charts please check the following before contacting C-MAP:

- Check that the charts are available, with the chart management function.
- Check that the license is correctly installed, with the license function.

Contact Information: For information please call you're nearest C-MAP Office or contact C-MAP. E-mail: technical.marine@c-map.com

10.5 Chart Display

10.5.1 Introduction

The two type of C-MAP charts can be displayed together. These charts have the priority order shown below.

- 1) C-MAP ENC
- 2) C-MAP PROFESSIONAL+

If the same navigational purpose charts are available over an area, priority is as shown above. Areas where ENC is not available C-MAP ENC charts are shown. Where C-MAP PROFESSIONAL+ are available, C-MAP PROFESSIONAL+ charts are displayed.

The [Chart Legend] dialog box provides various information about the C-MAP chart currently displayed. The information can be displayed two ways:

- For current position: Click the [TM/CU Reset] button while in the Voyage navigation mode then click the [Chart INFO] button on the InstantAccess bar™ followed by the [Chart Legend] button.
- For a specific location: Put the cursor on the location then right-click and select [Chart Legend].

To close the dialog box, click the [Close] button.

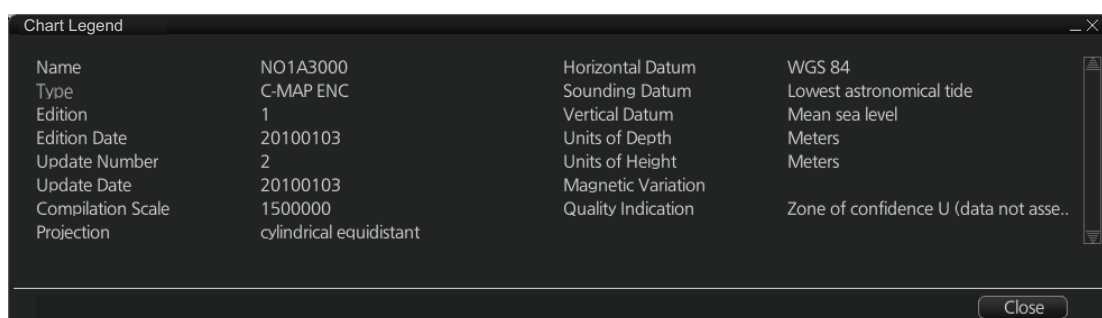

Name: Name of chart.

Type: Type of chart.

Edition: Edition number of the chart.

Edition Date: Date the edition was published.

Update Number: Update number

Update Date: Date of update

Compilation Scale: The scale of the original paper chart is shown here.

Projection: Projection of current chart.

Horizontal Datum: Horizontal datum used with current chart.

Sounding Datum: Datum used to create sounding data.

Vertical Datum: Vertical datum used with current chart.

Units of Depth: Unit of depth used with current chart.

Units of Height: Unit of measurement used to measure height of objects above sea level.

Magnetic Variation: Amount of magnetic variation. A positive value indicates a change in an easterly direction and a negative value indicates a change in a westerly direction.

Quality Indication: Quantitative estimate of the accuracy of chart features, given by the chart producer.

10.6 Permanent Warnings

Permanent warnings help you keep the C-MAP up-to-date and these are shown at the bottom of the screen. Permanent warnings appear if the system detects a condition that may cause a chart to be not up-to-date.

Message	Meaning, Remedy
[C-MAP]: Database not up to date	Database is not up to date. Update the data base.
[C-MAP]: No connection to eToken	eToken dongle is not connected (inside the Processor Unit) or the eToken has not been initialized. If the dongle is connected, open the [License] dialog box, click the [C-MAP] tab, then click the [C-MAP Setup] and [OK] buttons to initialize the eToken.
[C-MAP]: permits have expired	You have an expired permit for a chart. Remove the chart or renew subscription for the permit.
No connection to dongle.	Dongle not connected. Connect dongle.
Permit expired (SSE 25): XXXXXXXX (Chart name replaces Xs.)	You have an expired permit for a chart. Remove the chart or renew subscription for the permit.

10.7 Notice to Mariners (NM)

The NM has been developed to ensure mariners can simply view the information they need - in addition to the standard chart - to navigate safely and compliantly. By clearly showing where important Temporary or Preliminary changes may impact a voyage, the NM will give seafarers the same consistent picture of the maritime environment on their charts as they have always had.

The display and operation methods for NM is essentially the same as AIO. See section 9.5 for details.

How to select the NM information to display

Select what type of notices to display as follows:

1. Click the [DISP], [SET] and [Chart DISP] buttons on the InstantAccess bar™.
2. Click the [NtoM] tab.

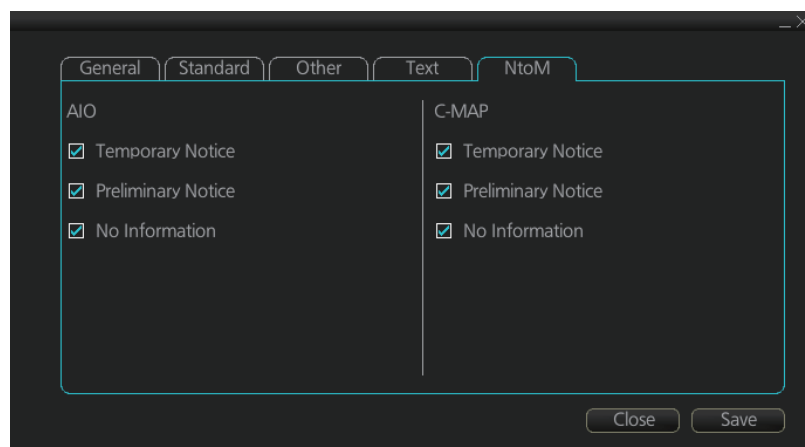

3. In the [C-MAP] window, check the items to display.
4. Click the [Save] button to save settings then click the [Close] button to close the menu.

11. CHART ALERTS

The chart radar can detect areas where the depth is less than the safety contour or detect an area where a specified condition exists. If prediction of own ship movement goes across a safety contour or an area where a specified condition exists, the system does the following:

- Highlights alarm level alert objects in red (route checked in route planning, and route navigation)
- Highlights warning and caution level alert objects in yellow (route checked in route planning, and route navigation)
- Provides visual alerts in the [Alert] box for alarm, warning and caution level alert objects (route navigation)
- Sounds an aural alarm for alarm or warning alert objects (route navigation)

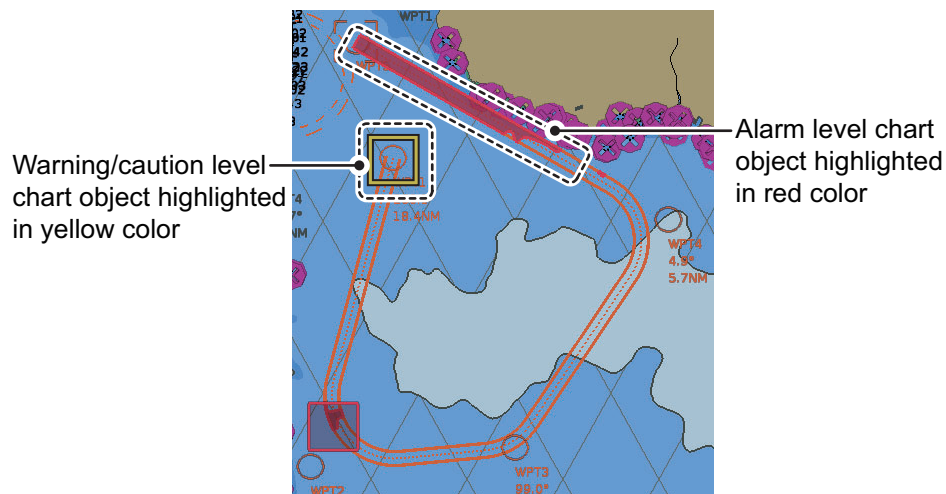

For this function, the chart radar utilizes the chart database (S57 charts) stored on the SSD in SENC format. **Note that the chart radar calculates dangerous areas using the largest scale chart available, which may not be the visualized chart.**

You can select objects that are included for calculation of danger area (for example, restricted areas). A dialog box lists the various areas that activate danger warnings.

You can also define your own safe area by creating a user chart area. The system can utilize these areas when calculating chart alerts.

- The system can check the following for you:
 - Predicted movement area of own ship
 - Planned route with an easy to use locator function to find dangerous areas
- The system will highlight the following for you
 - Dangerous areas inside predicted movement area of the own ship
 - Dangerous areas inside your monitored route
 - Dangerous areas inside your planned route

11.1 Chart Alerts

Official S57 chart material contains depth contours that can be used for calculation of chart alerts. A chart database also includes different types of objects that the operator can use for chart alerts. The procedure for setting chart alerts is outlined below.

1. Select suitable safety contour for your own ship. See subsection 11.1.1 for how to set the safety contour.
2. In the Voyage planning mode, define a new route or select an existing one. Make a chart alert calculation of the route if there are indications of danger areas in the route. Modify your route if necessary and do the chart alert calculation again. To modify an existing route see section 12.5.
3. Select route as monitored route.
4. Set the look-ahead area for your own ship (see section 11.2).

The system is now ready for chart alert calculation of monitored route and estimated own ship position.

11.1.1 How to set safety contour

Select safety contour suitable for the own ship.

1. Click the [DISP], [SET] and [Chart Alert] buttons on the InstantAccess bar™ to show the [Chart Alert] page.

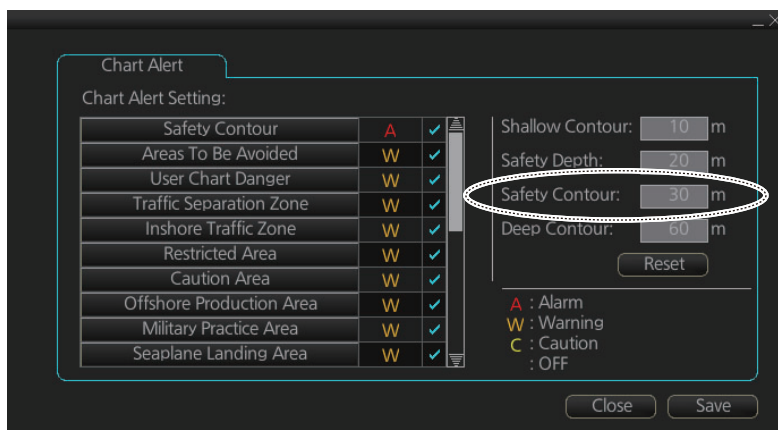

2. Enter desired depth at [Safety Contour] then click the [Save] button.

Any safety contours on the chart are highlighted with a thick gray line.

Note 1: The safety contour is not a new depth contour created by ECDIS - it is the highlight and activation of an existing contour line already present on the chart.

Note 2: If the chart does not contain chosen depth contour, the system will automatically choose next deeper contour.

11.1.2 Chart object related settings

When using the Look-ahead function or monitoring a route, you can set up the method in which to report chart alerts and also show/hide chart highlights.

1. Click the [DISP], [SET] and [Chart Alert] buttons on the InstantAccess bar™ to show the [Chart Alert] page.

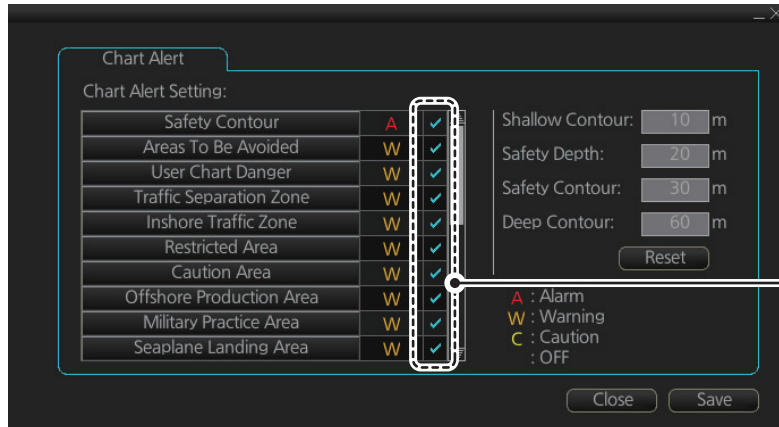

Check to show highlights, uncheck to hide highlights

2. Click a letter indication to select the type of alert, warning or caution, to receive for the given chart object. [Safety Contours] is fixed to "A" (Alarm).
 - **W**: Warning, visual and aural alerts
 - **C**: Caution, visual alert only
 - **No display** (OFF): No alert notification. Available with objects other than [No Vector Chart].
3. Click the box to the right of the letter indication to show a check mark and show the chart highlight. Click the box again to remove the check in the box and hide the highlight. Highlights are colored according to alert priority:
 - **A** (Alarm): Red color highlight
 - **W** (Warning) and **C** (Caution): Yellow color highlight
4. Click the [Save] button to finish.

Note 1: C-MAP PROFESSIONAL+ charts may take several minutes to identify danger areas.

Note 2: The Type of Alert setting must be the same for all connected FMD-3x00/FAR-3xx0/FCR-2xx9.

List of areas

There are areas that the chart radar detects and provides the audible alert and/or visual alert if the estimated own ship position, or planned or monitored route, crosses the area defined on the [Chart Alert] page. You can select from the following areas:

- Safety Contour
- Navigational Hazard
- Areas To Be Avoided
- User Chart Danger
- Traffic Separation Zone
- Inshore Traffic Zone
- Restricted Area
- Caution Area
- Offshore Production Area
- Military Practice Area
- Seaplane Landing Area
- Submarine Transit Lane
- Anchorage Area
- Marine Farm/Aqua Culture
- PSSA Area
- No Vector Chart
- Too Many Dangers
- UKC Limit
- Sounding UKC Limit
- Non-official ENC
- Not Up-to-date
- Permit Expired

11.2 How to Activate Own Ship Look-ahead Area

Calculation of own ship predicted movement area is done using a check area about own ship position. Set the look-ahead area as follows:

1. Select the [Look-ahead] page from the [Overlay/NAV Tools] box.

Note 1: The [ON]/[OFF] button may not be shown depending on installation setting.

Note 2: When Back-up ECDIS mode is active, the [ON]/[OFF] button is hidden and look-ahead is fixed at [ON].

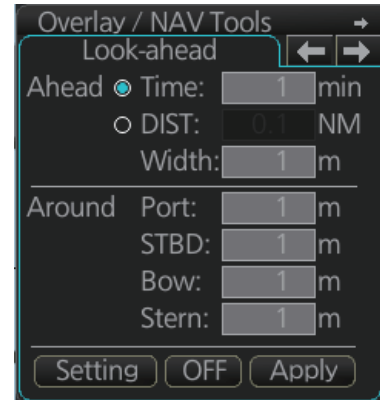

2. Set the ahead time or distance and ahead width, referring to the figure below. Also, set the "Around" figures: port, starboard, bow and stern check distance. The reference point is the conning position (CCRP).

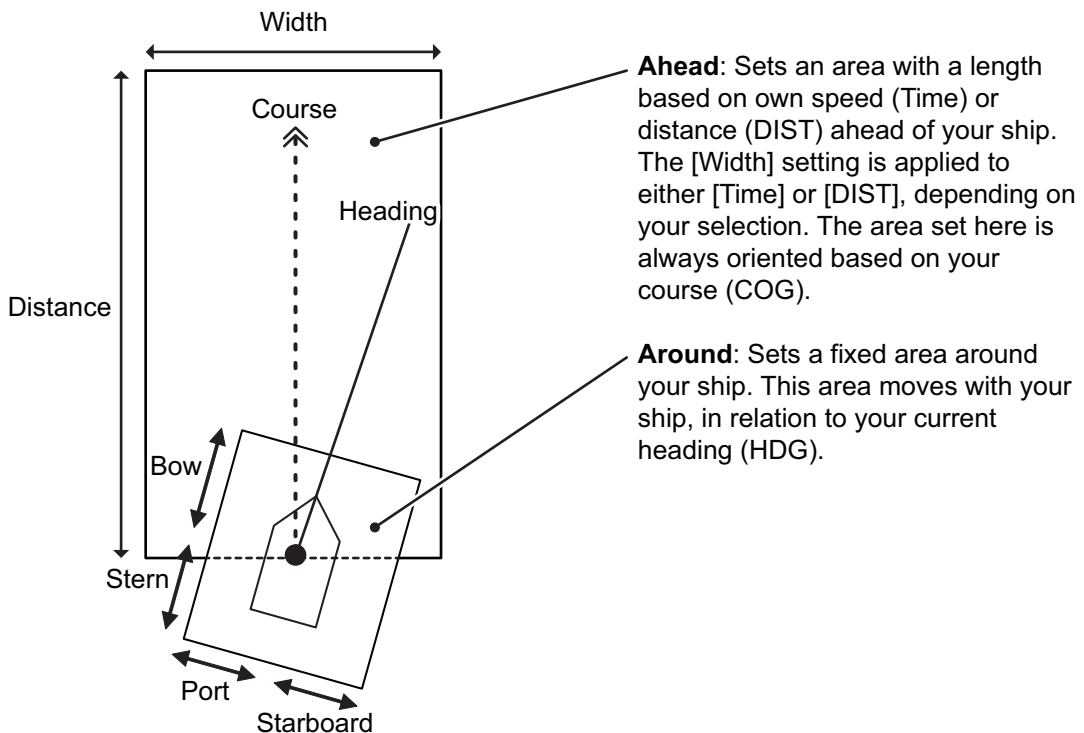

3. To select the objects to use in chart alerts, click the [Chart Alert] button and see subsection 11.1.2.

When an object set from the [Chart Alert] menu enters a set area, an alert is generated in the following manner:

- Alarm or Warning level alerts: Alert message and aural alert are generated.
- Caution level alerts: Alert message is generated (no aural alert).

Objects or areas that generate an alert are shown in the following manner. (Alarms: red highlight, Warnings/Cautions: yellow outline)

- Individual objects: The object is highlighted in red or outlined in yellow.
- Area objects: If the area object is larger than the look-ahead area, the look-ahead area is highlighted in red or outlined in yellow. If the area object is smaller than the look-ahead area, the area object is highlighted in red or outlined in yellow.

11.3 Route Planning

The system will calculate chart alerts using user-defined channel limit for routes. Danger areas are shown highlighted if safety contour or user-chosen chart alert areas are crossed by the planned route. For more information on route planning, see chapter 12.

Note: If your voyage is going to take a long time or you are planning it much earlier than it is to take place, use the Display date and Update Review dates corresponding to the dates you are going to sail (see section 9.2.2).

11.3.1 Chart alerts for route planning

You can generate a list of chart alerts that are crossed by the planned route. This can be done as follows:

1. Enter safety contour you want to use.
2. Plan a route; define waypoints and other necessary information. See chapter 12 for route planning.
3. Select dangerous objects to be monitored during route monitoring, on the [Alert Parameters] page in the [Route Plan] dialog box, shown below. Click the box below each object to show or hide the check mark.

When the route is checked, alert objects with a check mark which have their alert activated are highlighted on the chart display. Alert objects with no check mark are not highlighted.

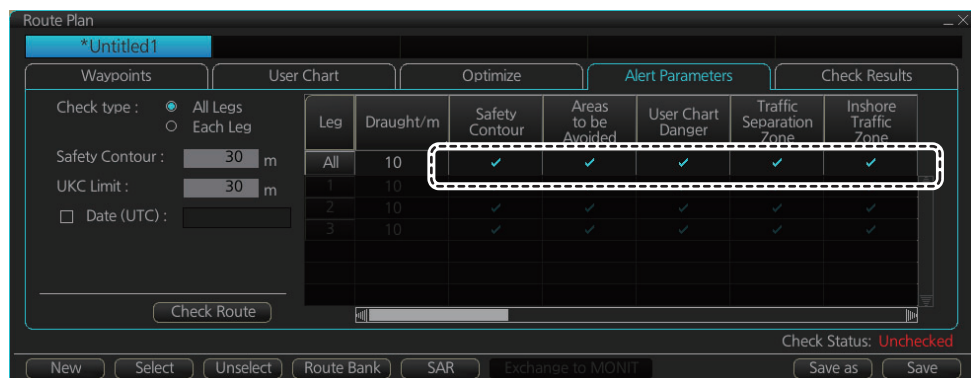

4. Click the [Check Route] button to generate a list of chart alerts. The results appear on the [Check Results] page.



The figure above shows the alerts to be monitored. If there are alerts included in the planned route, check alerts leg by leg, or check alerts by using category of alert.

11. CHART ALERTS

Note: When alerts are unchecked at step 3 in the above procedure, one or more of the following messages appear in the permanent warning box.

- [Safety Contour] unchecked: "Indication of crossing safety contour if Off. (in planning)"
- [Navigational Hazard] unchecked: "Indication of navigational hazards is Off. (in planning)"
- Other alerts unchecked: "Indication of some prohibited areas or areas with special conditions is Off. (in planning)"

12. ROUTES

12.1 Route Planning Overview

A route plan defines the navigation plan from starting point to the final destination. The plan includes:

A route plan defines the navigation plan from starting point to the final destination. The plan includes:

- Route name
- Name, latitude and longitude of each waypoint
- Radius of turn circle at each waypoint
- Safe channel limits
- Chart alarm calculation based on channel limits against chart database and user chart danger
- UKC calculation
- Deadband width, nominal deadband width used for the chart operating modes with moderate accuracy and economical sailing behavior
- Minimum and maximum speed for each leg
- The navigation method (rhumb line, great circle)
- Fuel saving
- ETD from each waypoint
- ETA to each waypoint
- Ship and environmental condition affecting the ship speed calculation
- Name of the user chart to use during route navigation together with the planned route
- Name of the Notes to use during route navigation together with this planned route, in the user chart dialog box

Using the above-mentioned data, the system calculates speed, course and length for each leg, ETAs for each waypoint, fuel consumption and WOP. It also calculates safe water areas based on user-defined channel limits. The calculated data is displayed in tabular form, which can be printed as a documented route plan and also stored in a file for later use.

Main functions of route planning are:

- Define waypoints (maximum of 200 waypoints per route)
- Define turnings for each waypoint
- Define channel limits for each leg (a leg is the line connected between two waypoints). The channel limits are used to detect chart alerts when you are planning or monitoring your route.
- Define the speed for each leg
- Calculation for ETD and ETA
- Calculation for most economical sailing

Note 1: If you have small scale chart(s) on display having the whole eastern/western (0-180°E/0-180°W) hemisphere and a part of the other hemisphere on display, there is a limitation to display a route. To avoid this, set chart center so that the whole eastern/western hemisphere is not on the display. A maximum of five routes can be edited simultaneously.

Note 2: If a planned route's Safety Margin or Channel Limit contains excessive land masses, the chart radar may freeze during a route check. If this occurs, reset the chart

radar, then adjust the Channel Limit and Safety Margin settings in the Route Plan dialog box's Waypoints so that land mass is not included in the route.

12.2 Main Menu for Route Planning

The main parameters for the route planning are:

- Latitude and longitude of the waypoint
- Channel limits to the waypoint
- Turning radius of the waypoint
- Maximum speed limit and planned speed for each leg

There are two phases for a route: Route Plan and Route Monitor. Route plan is used for planning the route and route monitor is used to control a route for monitoring.

To complete route planning, do the following.

1. Create a new route or select an existing one. See section 12.4.
2. Modify your route if necessary. See section 12.5.
3. Make chart alert (safe water) calculation. See section 12.4.5.
4. Optimize your route. See section 12.8.

12.3 How Route Data is Synced

Route data can be shared between this ECDIS and other like units (FMD-3x00, FCR-2xx9, FAR-3xx0), through the LAN. A minimum of two units is required. Turn on all units beforehand to enable syncing. The sync source (master unit) is automatically assigned by the system when each unit is powered. For configurations with three or more units, two units are assigned as a sync source and have priority regardless of their power status (ON or OFF). The priority is assigned as follows:

- 1) ECDIS unit assigned as the Planning ECDIS.
- 2) ECDIS unit assigned with the lowest unit number at installation.
- 3) CHART RADAR unit assigned with the lowest unit number at installation.

Be aware that if a unit is turned off, some route data may be deleted. Two examples are shown below.

Using ECD001 and ECD002

This example assumes that ECD002 is assigned as a Planning ECDIS.

1. ECD002 is off; ECD001 is powered and a route is created at ECD001. Even though ECD002 is the Planning ECDIS, route data is not transferred to ECD002 because the power is turned off.
2. ECD002 is turned on. As this unit is assigned as a Planning ECDIS, ECD001's route data is deleted.

Using ECD001, ECD002 and CRA001

This example assumes that ECD001 and ECD002 is assigned as a Planning ECDIS.

1. ECD001/002 are both turned off; CRA001 is powered and a route is created on CRA001. Route data is not transferred as both ECD001 and ECD002 are turned off.
2. ECD001 is turned on. As this unit is assigned as a Planning ECDIS, CRA001's route data is deleted.

If the operator clicks the PLAN button on the Status bar when one or more units (including the master unit) is turned off, one of the following messages appears.

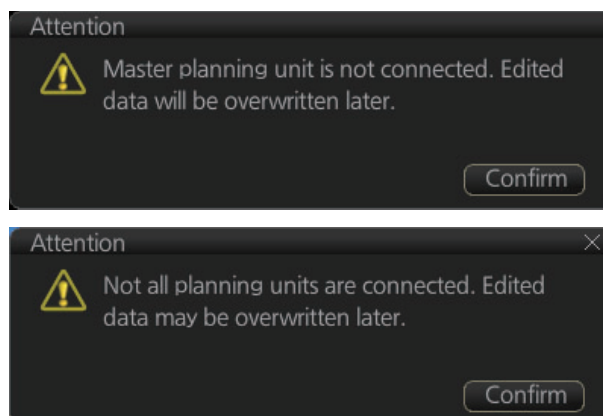

Turn all units in the same network on, then plan or edit the route as required.

12.4 How to Create a New Route

To make a complete route for a voyage, do the following:

1. Click the [PLAN] button on the Status bar to activate the Voyage planning mode.
2. On the InstantAccess bar™, click the [Planning] button followed by the [Route] button to open the [Route Plan] dialog box.
3. Click the [New] button.

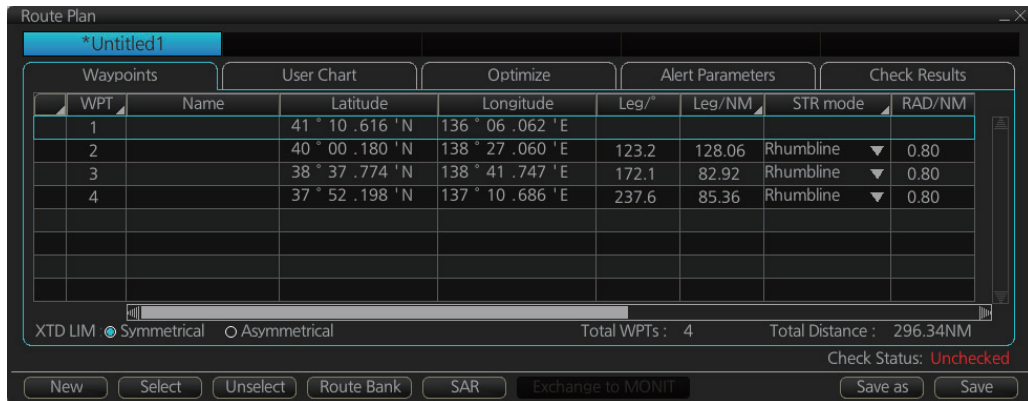

WPT	Name	Latitude	Longitude	Leg/°	Leg/NM	STR mode	RAD/NM
1		41 ° 10 .616 'N	136 ° 06 .062 'E				
2		40 ° 00 .180 'N	138 ° 27 .060 'E	123.2	128.06	Rhumbline	0.80
3		38 ° 37 .774 'N	138 ° 41 .747 'E	172.1	82.92	Rhumbline	0.80
4		37 ° 52 .198 'N	137 ° 10 .686 'E	237.6	85.36	Rhumbline	0.80

XTD LIM: Symmetrical Asymmetrical
 Total WPTs: 4 Total Distance: 296.34NM
 Check Status: **Unchecked**

Buttons: New, Select, Unselect, Route Bank, SAR, Exchange to MONIT, Save as, Save

Note: When accessing the database is failed after pressing the [New] button, the message "Database access failure occurred. You can make a route but cannot save it." appears. Contact your dealer in this case.

4. Use the cursor to select a position for the first waypoint then push the left mouse button. A waypoint mark appears on the position selected, and the latitude and longitude of the position, etc. are entered into the [Route Plan] dialog box. After entering a waypoint, edit Name, Steering mode* ([Rhumbline] or [Greatcircle]), Radius*, XTD limit*, Plan SPD*, SPD Max*, Margin* and Local Time* as appropriate in the [Route Plan] dialog box, using the keyboard on the Control Unit or the software keyboard. (*: Editable for waypoint 2 and thereafter only.)
 For how edit the details, see section 1.12.3 and section 1.12.4.

Note 1: A guide box that shows the range and bearing between waypoints as you drag the cursor is available. You can show or hide the box with the [Guide Box] button on the InstantAccess bar™. Click the button to show its background color in light-blue and display the guide box.



Note 2: The bearing and range of the waypoint can be adjusted as shown below.

- 1) In the [Route Plan] dialog box, right click the bearing or the distance of the waypoint to change.
- 2) Select [Adjust Position] to show the [Adjust Waypoint] context menu shown right.
- 3) Enter value at [Direction] or [Distance], then click the [OK] button.

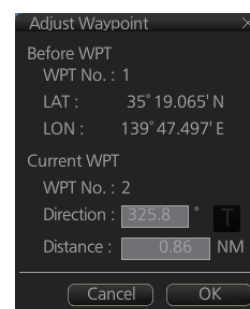

5. Repeat step 4 to enter other waypoints.
6. After you enter the final waypoint, right-click the display area to show the context-sensitive menu then select [Finish].
7. Click the [Save] button. Enter a name (max. 63 alphanumeric characters) for the route, using the keyboard on the Control Unit or the software keyboard. Click the [OK] button to finish.
8. Use the [Alert Parameters] page to define the safety contour and other specified conditions for checking the route. Click a "block" under a check item to highlight the areas. Also, input value for [Draught/m]. A parameter for [Draught/m] can also be assigned globally to all legs from the context-sensitive menu. See section 12.4.4 for how to use the [Alert Parameters] page.
9. Use the [Check Route] button on the [Alert Parameters] page to detect areas where the depth is less than the safety contour or where specified conditions exist. The results appear on the [Check Results] page. This system can examine chart database against planned route to make a list of alerts where a route crosses a safety contour or specified areas used in chart alerts.
10. Use the [User Chart] page to link, de-link a user chart(s) with the route. See section 12.4.2.
11. Use the [Optimize] page to enter parameters for route optimization. See section 12.4.3.



How to use the Undo feature

The Undo feature, available when creating a route and a user chart, can be accessed from the [UNDO] button on the InstantAccess bar™. In route creation the feature is used with waypoint and text input as follows:

Waypoint input: Delete last-entered waypoint.

Text input: Erase last-entered character or character string.

12.4.1 How to use the Waypoints page

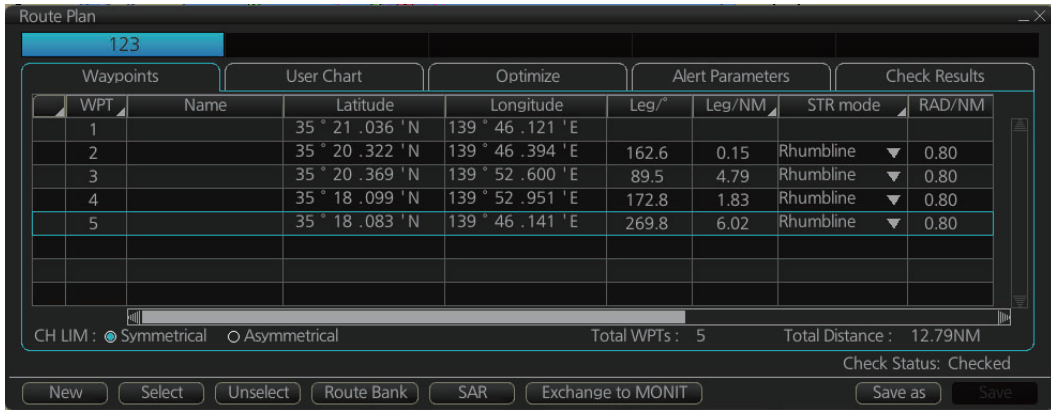

The following fields and boxes can be found in the [Waypoints] page. Scroll the list rightward to see hidden items.

<p>[WPT]: Each waypoint has a number.</p> <p>[Name]: You can name each waypoint.</p> <p>[Latitude]: WPTs latitude coordinate is displayed in WGS-84 datum.</p> <p>[Longitude]: WPTs longitude coordinate is displayed in WGS-84 datum.</p> <p>[Leg/°]: Bearing of leg (True: reference to North)</p> <p>[Leg/NM]: Length of leg (nm). Edit the indication of leg to show as follows;</p> <ol style="list-style-type: none"> Right-click the column title [Leg/NM]. Select the contents to show. <ul style="list-style-type: none"> [Each]: Shows the distance of each leg. [Total]: Shows the total cumulative distance from leg to leg. [Remain]: Shows the distance remaining from leg to leg. <p>Note: These settings are reflected to [Leg/NM] in the [Waypoints] page of the [Monitor Information] dialog box.</p> <p>[STR Mode]: Define steering mode for each leg - rhumb line or great circle. Click to select [Rhumbline] or [Greatcircle].</p> <p>[RAD/NM]: Define turning radius for each waypoint. To change a radius, put the cursor in this column to show up and down arrows. Click the arrows to set the radius.</p>	<p>[XTD Limit/m]: For [Symmetrical] selected at the radio button, define channel limit for each leg. For [Asymmetrical] selected, define channel limit for port, starboard side for each leg at [XTD Port/m] or [XTD STBD/m] respectively.</p> <p>[Plan SPD]: Define planned speed to use with a leg.</p> <p>[SPD Max]: Define maximum speed to use with a leg.</p> <p>[Margin/m]: Define extension for channel to be checked against selected alerts.</p> <p>[PL 1/m, PL 2/m]: One or two sets of parallel lines, colored orange, can be drawn on a route. Set the distance (in meters) to offset the lines from the route, from -99999 to 99999. Parallel lines allow the navigator to maintain a given distance away from hazards. See the illustration below.</p> <p>[XTD LIM]: Define channel limits.</p> <ul style="list-style-type: none"> [Symmetrical]: Define channel limit for each leg. [Asymmetrical]: Define channel limit for port, starboard side for each leg, at [CH Port/m], [CH STBD/m], respectively. <p>[Local Time]: Define the local time at which the waypoint is passed.</p>
---	---

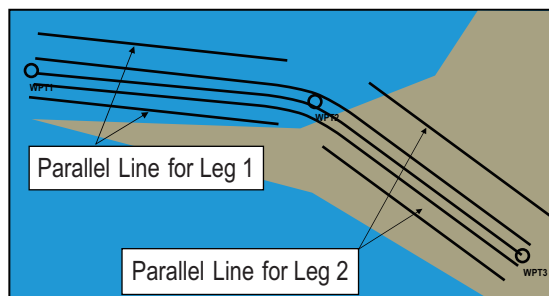

Note: You can select the route information data to display on the [Waypoints] page with the context-sensitive menu. Right-click an item from [WPT] to [PL 2/m] then select [Edit Columns] to show the context-sensitive menu. Check or uncheck items as appropriate then click the [OK] button.

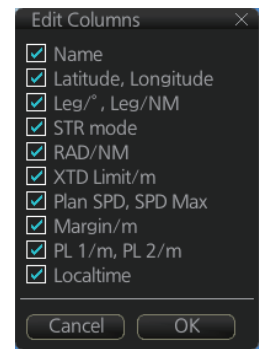

12.4.2 How to use the User Chart page

The [User Chart] page lets you link user charts to routes. To link a user chart, click the box to the left of the user chart name in the [Stored User Chart] list to show a checkmark. Click the [<<] button to copy that name to the [Linked User Chart] list. To de-link a user chart, click the box to the left of the user chart name in the [Linked User Chart] list then click the [>>] button to erase the name. The contents of each user chart are shown in the [Contents] window.

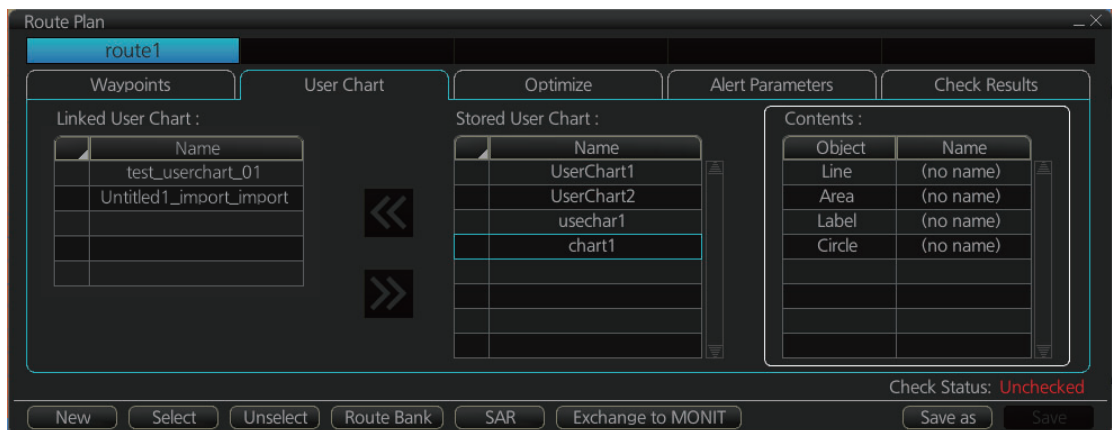

[Linked User Chart]: List of user charts linked with selected route.

[Stored User Chart]: List of stored user charts.

[<<] button: Link a stored used chart. Check the chart in the [Stored User Chart] list then click this button. The user chart name is then copied to the [Linked User Chart] list.

[>>] button: Click to remove selected (checkmarked) user chart from the [Linked User Chart] list.

[Contents]: Lists the objects saved to the user chart selected.

12.4.3 How to use the Optimize page

After all waypoints are inserted and you have made safe water calculation, you can optimize your route, on the [Optimize] page. If not selected, then optimization will be done automatically with max. speed. If you want do optimization with a specific strategy, see section 12.8 for how to optimize a route.



[Type]: Select optimization strategy: maximum speed, time table, maximum profit, or minimum cost.

[Set ETD]: Set date, time and waypoint to start from.

[Parameters]: Set the parameters for optimization, speed limit and income (max profit).

[Edit Cost Parameters] button: Enter fuel consumption figures. See section 21.3.

[Set ETA]: For the type [Time table], set the date and time that you want to arrive at the waypoint selected.

[Optimized Speed/ETA]: The optimized speed for the date and time entered at [Set ETA] appears here, after clicking the [Calculate] button.

[Calculate] button: Click to calculate optimization.

[Apply to Route] button: Apply the calculations on the [Optimize] page to the route.

12.4.4 How to use the Alert Parameters page

The [Alert Parameters] page sets the alert conditions to use when checking a route. Put a “W” for an item to highlight on the chart. ([Safety Contour] is fixed to “A” (Alarm). If you do not require the highlight display for an item, put a “C” for that object. The relevant alerts (Alarm, Warning, Caution) are shown in the [Check Results] page.

You can select the safety contour and chart alerts used to check the safety of the route. This allows you to check the safety with conditions different from those selected n for system use. This is useful when making a route for different loading or sailing conditions.



Item	Description	Item	Description
Check type	Check how to apply the alerts, to every leg or individual leg. (Only [Draught] can be applied to every leg.)	Offshore Production Area	Offshore production area
Safety Contour	Set the safety contour (in meters).	Military Practice Area	Military practice area
UKC Limit	Under keel clearance limit.	Seaplane Landing Area	Seaplane landing area
Date (UTC)	A chart may have date-dependent features. Enter the actual data of embarkation to know date-dependent features.	Submarine Transit Lane	Submarine transit lane
Leg	Leg number	Anchorage Area	Anchorage area
Draught/m	Ship's draught	MarineFarm Aquaculture	Marine farm aquaculture
Safety Contour	Safety contour	PSSA Area	Particularly Sensitive Sea Area
Navigational Hazard	Navigational hazards	No Vector Chart	No vector chart for area.
Areas to be Avoided	Areas to be avoided	Too Many Dangers	Too many dangerous areas/objects.
User Chart Danger	User chart danger area	UKC Limit	
Traffic Separation Zone	Traffic separation zone	Sounding UKC Limit	Particularly Sensitive Sea Area
Inshore Traffic Zone	Inshore traffic zone	Non-official ENC	No official ENC data
Restricted Area	Restricted area	Not Up-to-date	Chart not up to date.
Caution Area	Caution area	Permit Expired	Permit for chart has expired.

Context sensitive menus

A context-sensitive menu for setting the draught is available on the [Alert Parameters] page. Right-click [Draught/m] to show the menu. [Set "ALL" setting to all legs] applies the draught value of [Check type: All Legs] to all legs. [Clear setting] restores previous settings for each leg.

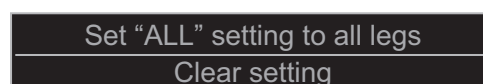

12.4.5 How to use the Check Results page

The [Check Results] page allows you to make safe water calculation for your route. Click the [Check Route] button to do the check. After the button is operated, the alert type and latitude and longitude position of the alert appear for applicable legs on the route.

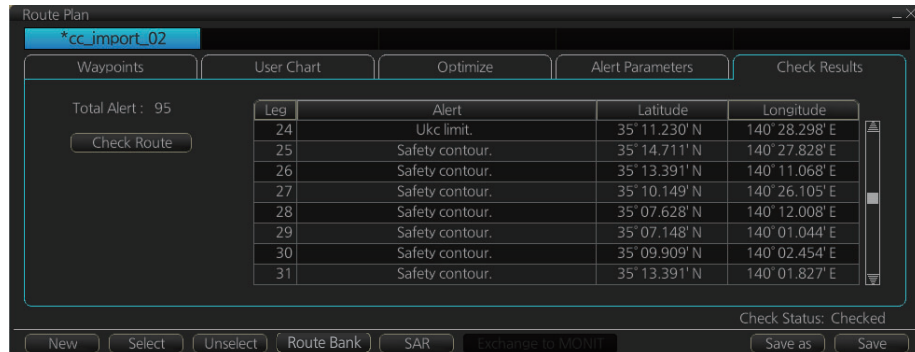

Note 1: In order to display charts with correct updated situation, always use current date during your voyage. If your voyage lasts more than one week, set current date at least once per week during your voyage.

Note 2: A route check can take longer with C-MAP charts. Wait until the completion of the check.

Note 3: When a chart is installed or updated, use the [Check Route] button on the [Alert Parameters] page to re-check all routes before starting any voyage. If a route which has not been checked is selected for a voyage, the error message "Route check is not done in PLAN mode." appears at the bottom of the monitor page.

12.5 How to Modify an Existing Route

12.5.1 How to change waypoint position

To change position of a waypoint you have the following choices:

- Drag and drop waypoint using the left button.
- Enter latitude and longitude on the [Waypoints] page in the [Route Plan] dialog box.

How to drag and drop waypoint to new position

1. Put the cursor on the route waypoint to move then push the right button to show the context-sensitive menu.
2. Select [Edit].
3. Press and hold down the left button while rolling the trackball to move the cursor to a desired position. Release the button when the cursor is at the desired position. Right-click the display area to show the context-sensitive menu then select [Finish].

How to change latitude and longitude from the Waypoints page

1. Show the [Waypoints] page.
2. Put the cursor on the digit to change in the Latitude or Longitude field.
3. Enter position from the Control Unit's keyboard, or spin the scrollwheel.

12.5.2 How to change other waypoint data

Other data of a waypoint, such as name, steering mode, turning radius, min/max speed, can be edited from the [Waypoints] page. Select the route to edit and open the [Waypoints] page. Put the cursor on a desired field and spin the scrollwheel to change data. (Push the left button to change steering mode.)

12.5.3 How to add a new waypoint at the end of a route

How to add a new waypoint at the end of a route from the electronic chart area

1. Put the cursor on the current last waypoint of the route.
2. Right-click the display area to show the context-sensitive menu then click [Edit].
3. Put the cursor to the new location for the last waypoint then push the left button.
4. Right-click, then click [Finish].

How to add a new waypoint at the end of a route from the Waypoints page

Open the [Waypoints] page then right-click the last waypoint. Select [Insert after]. A waypoint is added at the end of the list. Edit the Latitude, Longitude, etc. as necessary.

12.5.4 How to insert a waypoint

How to insert a waypoint between waypoints from the electronic chart area

1. Put the cursor anywhere on the route where you want to insert a waypoint.
2. Right-click to show the context-sensitive menu then click [Edit].
3. Put the cursor on the leg where you want to insert a waypoint.
4. Right-click, then click [Insert WPT].
5. Right-click, then click [Finish].

How to insert a waypoint from the Waypoints page

Open the [Waypoints] page then right-click the waypoint to process. Select [Insert After] or [Insert Before] as appropriate. A waypoint is added after or before the waypoint selected. Edit the Latitude, Longitude, etc. as necessary.

12.5.5 How to delete a waypoint

How to delete a waypoint from the electronic chart area

Put the cursor on the waypoint to delete. Push the right button to show the context-sensitive menu then select [Edit] followed by [Delete WPT].

How to delete a waypoint from the Waypoints page

Open the [Waypoints] page. Right-click the waypoint you want to delete then select [Delete WPT].

12.5.6 Geometry check of route

When you add a new waypoint, modify a waypoint or change other waypoint data, the geometry check may reveal problems with the route. The problem(s) are indicated in red and an appropriate message appears, also in red, on the [Waypoint] page. Refer to the descriptions in this section for the geometry check error messages and the remedies necessary to fix the route.

“Impossible turn at WPT XX” (XX=WPT no.)

The error message, next longitude and latitude and/or a turn radius appear in red.

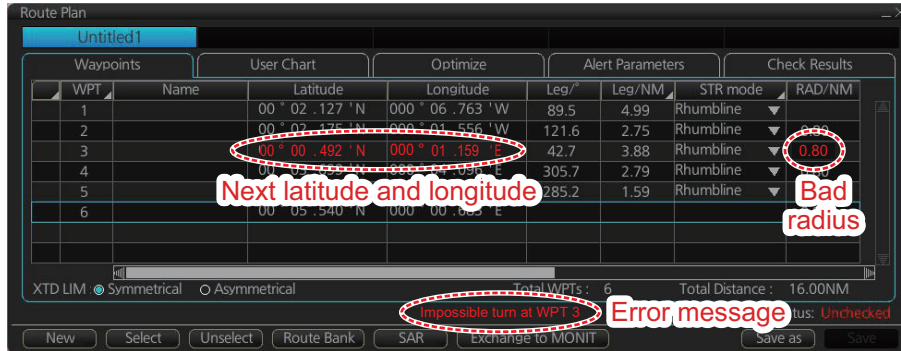

This means that the geometry of route makes it impossible for the ship to accomplish a turn. Typically, it is sufficient if you do the following, on the [Waypoints] page.

- Decrease the turn radius of the waypoint.
- Change latitude and longitude position of the waypoint or one of its neighbors.

“Bad Leg WPT XX to WPT XX” (XX=WPT no.)

The error message and a pair longitude and latitude appear in red.

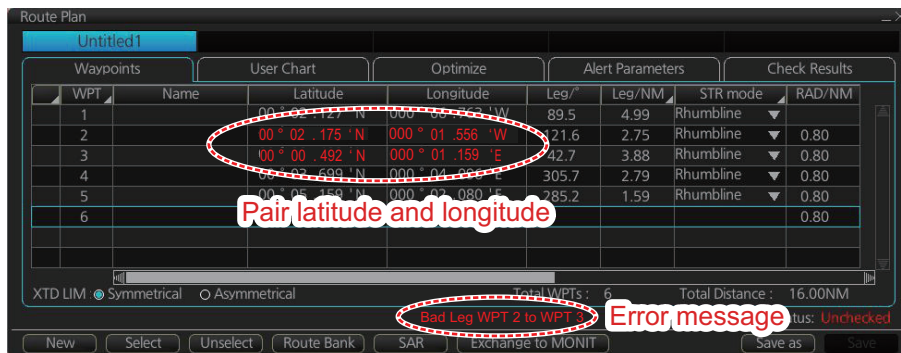

This means that the length of a leg is too short to accomplish a turn. Typically, it is sufficient if you do the following, on the [Waypoints] page.

- Change latitude and longitude position of the waypoint or one of its neighbors.

“Bad Turn at WPT XX” (XX=WPT no.)

The error message, turn radius and planned SPD indication (not shown in the figure below) appear in red.

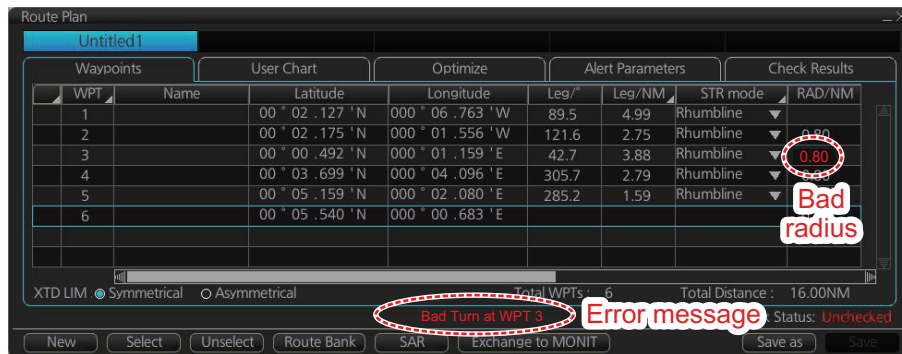

This means that the turn cannot be accomplished because the calculated ROT exceeds the MAX ROT. Typically, it is sufficient if you do the following, on the [Waypoints] page.

- Increase the turn radius of the waypoint.
- Decrease the planned SPD.

12.6 SAR Operations

The SAR feature facilitates search and rescue operations for MOB.

To use the SAR feature, get into the Voyage planning mode then do the following:

1. Click the [Planning] and [Route] buttons on the InstantAccess bar™ to show the [Route Plan] dialog box then click the [SAR] button.

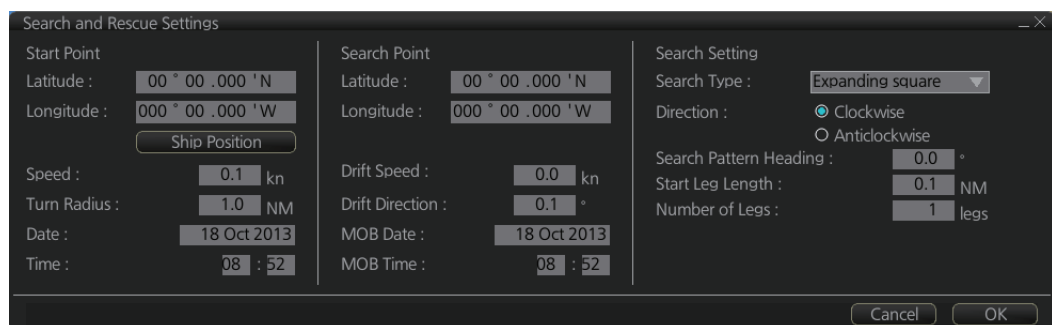

2. Enter your start point. To enter current position, click the [Ship Position] button. (The start point can also be entered directly on the screen. Put the cursor on the start point, right-click the chart to show the context-sensitive menu shown right then click [Set start point].)
3. Enter your ship's speed and turn radius, current UTC date and time.
4. At [Search Point], enter the estimated position of the object to search. (The search point can also be entered directly on the screen. Put the cursor on the search point, right-click the chart to show the context-sensitive menu shown at step 2 then click [Set search point].)

12. ROUTES

5. Enter drift speed, drift direction, and the UTC date and time of the estimated position.
6. At the [Search Setting] window, select and set the search type, referring to the table on the next page.

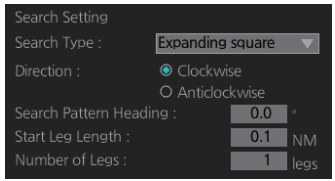
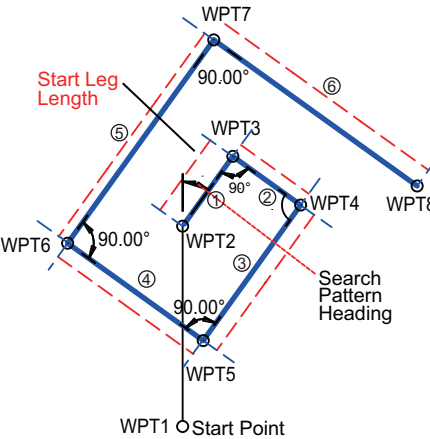
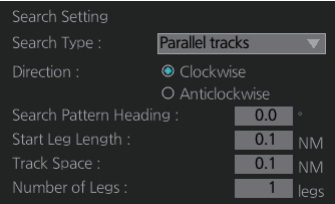
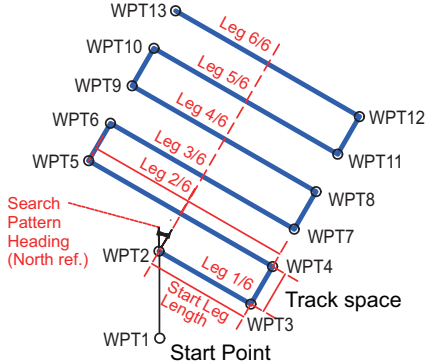
Search type	Options	Sample pattern
<p>[Expanding square]</p>	 <p>[Direction]: Set the direction to start the search, [Clockwise] or [Anticlockwise].</p> <p>[Search Pattern Heading]: See the right figure.</p> <p>[Start Leg Length]: Enter the start leg length.</p> <p>[Number of Legs]: Enter the number of legs to use.</p> <p>Starting at the probable location of the target, the search vessels expand outward in concentric squares.</p>	
<p>[Parallel tracks]</p>	 <p>[Direction]: Select the direction to start the search, [Clockwise] or [Anticlockwise].</p> <p>[Search Pattern Heading]: See the right figure.</p> <p>[Start Leg Length]: Enter the start leg length.</p> <p>[Track Space]: Enter the length of the short legs in the route.</p> <p>[Number of Legs]: Enter the number of legs to use.</p> <p>The parallel tracks pattern is usually the first pattern used in undertaking a search operation, since it assumes that the object to be searched.</p>	

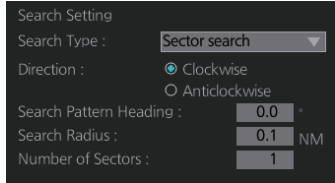
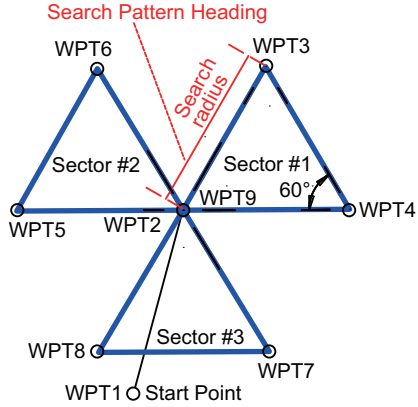
Search type	Options	Sample pattern
[Sector search]	 <p>[Direction]: Select the direction to start the search, [Clockwise] or [Anticlockwise].</p> <p>[Search Pattern Heading]: See the right figure.</p> <p>[Search Radius]: Enter the search radius (in NM).</p> <p>[Number of Sectors]: Enter the number of sectors to use.</p> <p>The sector search is used when the position of the body is known accurately and the search has to be done over a small area. It is normally carried out in the area, where the casualty or the object has been sighted.</p>	

7. Click the [OK] button. The [Route Plan] dialog box appears and the system draws the search and rescue route on the screen according to the search and rescue settings.
8. To follow the route, click the [Exchange to MONIT] button.

Note: To monitor the route the following conditions must be met:

 - The route must have at least two waypoints.
 - The route must have no impossible turns.
 - The route must have no bad turns.
 - The route must have no bad legs.
 - The route must have been checked.
9. To save the route, click the [Save] button and enter a name for the route, using the keyboard on the Control Unit or the software keyboard.

If necessary you can drag waypoints to new position, like with an ordinary route.

12.7 Route Bank

The route bank stores all the routes you have created. To show the route bank, in the Voyage planning mode, select [Planning], [Plan] to show [Route Plan] dialog box, then click the [Route Bank] button.

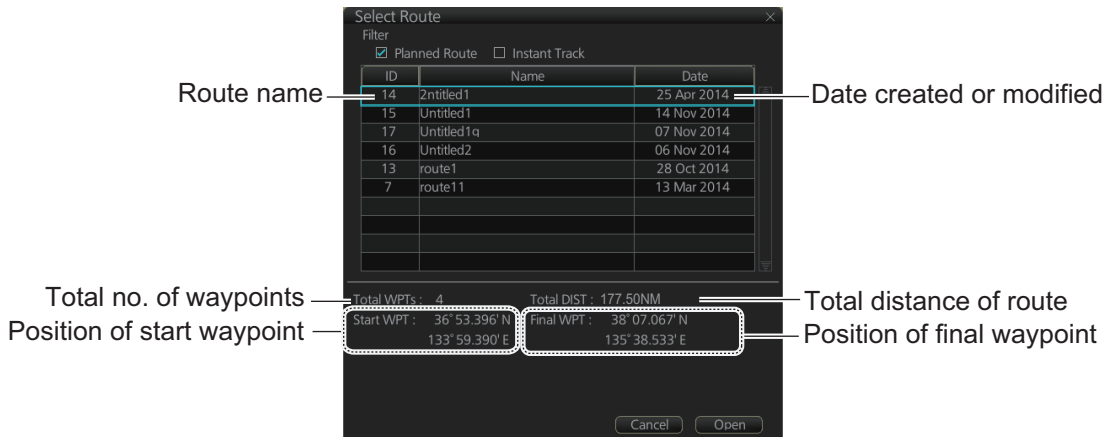

In the Voyage planning mode, the waypoints of a route can be inserted into the route currently selected.

1. Show the dialog box shown above.
2. Select the route for which you want to copy its waypoint(s) in the active route. For example, select Route2.
3. Click the [Open] button.

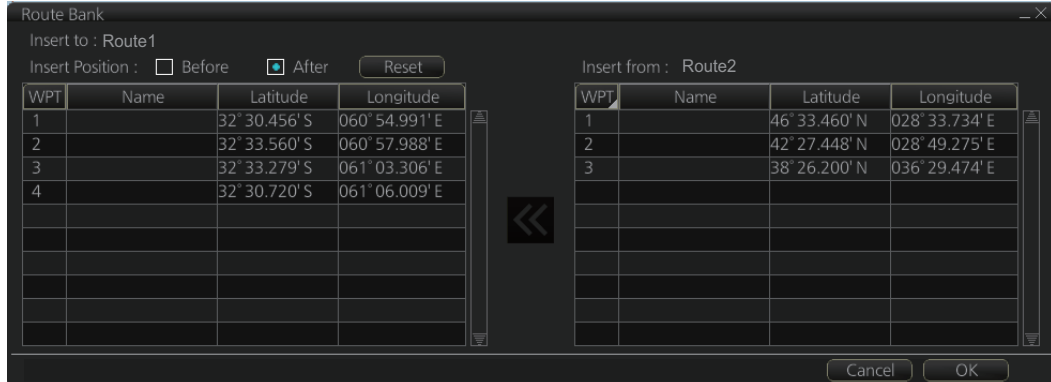

4. At [Insert Position], select where you want to insert waypoints into the active route, [Before] or [After] the waypoint selected in the next step. The [Reset] button restores the route to the original condition.
5. In the left-hand column set the cursor on the waypoint where to insert waypoints from the inactive route.
6. At the right-hand column, select the waypoint(s) to add to the active route. A context-sensitive menu is available by right-clicking [WPT] in the inactive route. The options available are [Select All], [Deselect All] and [Reverse] (reverse the order of the waypoints in the inactive route).

- Click the [<<] button to insert the waypoint(s) from the inactive route to the active route. In the example below, WPT1 of the inactive route is inserted at the end of the active route, becoming its waypoint 5.

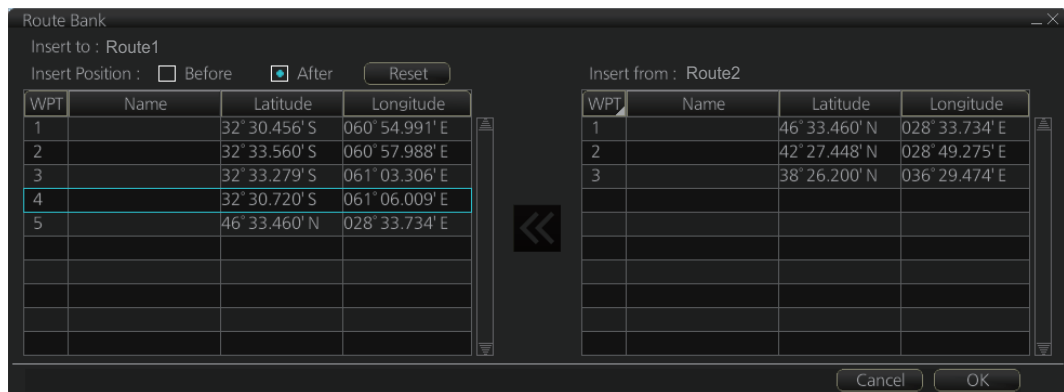

- Click the [OK] button to finish.

12.8 Route Optimization

12.8.1 Available route optimization strategies

After all waypoints are inserted, the route is optimized from the [Optimize] page in the [Route Plan] dialog box. If no optimization strategy is selected, the optimization is done with "max. speed," defined in ship parameters. Optimization calculates all parameters for route steering (course and distance between two waypoints, maneuvering start point, WOP, etc.). There are four methods for optimization:

[MAX speed]: This calculation uses the maximum speed defined in the ship parameters and multiplies by all reduction factors (weather, ice, fouling, etc.) together with speed limits given for each waypoint to generate ETA. ETA may be entered, however it is calculated with user-entered ETD and speed limit.

[Time table]: Calculates the speed required in order to arrive at destination at required ETA. Maximum speed is never exceeded. The user enters ETD and ETA to calculate speed to use. If the user-entered ETA is earlier than that found with the Max. Speed calculation, the Max. speed -calculated ETA will be indicated below the Time Table ETA calculation figure. The calculated speed is shown on the [Route Information] box as [Plan Speed].

[MAX profit]: Based on ETD, this calculation takes in account the fuel cost and the fixed cost of the ship and calculates the most profitable speed (highest profit per time unit).

[MIN cost]: Based on ETD, this calculation takes in account the fuel cost and the fixed cost of the ship and calculates the speed that gives the minimum total cost. You need to set [Cost Parameters] beforehand to use this feature.

12.8.2 How to optimize a route

You can define Estimated Time of Departure (ETD), desired number of waypoints and Estimated Time of Arrival (ETA) on the [Optimize] page in the [Route Plan] dialog box to optimize your route.

1. Click the [Optimize] tab to open the [Optimize] page.



2. At [Type], click the drop-down list to select desired optimization strategy, referring to subsection 12.8.1 "Available route optimization strategies".
3. Do the following:

- 1) At the [Set ETD] window, enter starting WPT and date and time of departure. To enter the date, click the gray box to the right of the [Date (UTC):] indication. The [Set date] window, shown right, appears. Click the applicable date in the calendar if you are going to depart during the current month, or click the applicable arrow on the month/year button to select a different date. Click the [OK] button to save the ETA and close the window.

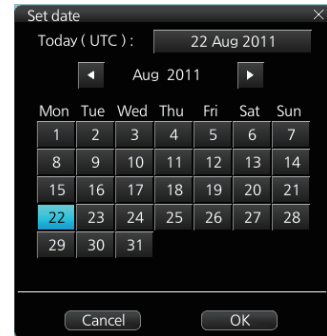

- 2) At the [Waypoints] window in the [Route Plan] dialog box, enter the maximum speed to use. For the Type [MAX profit], enter [Income] value. If necessary, click the [Edit Cost Parameters] button to enter fuel consumption values.



- 3) For [Time table], the [Set ETA] window appears. Set the ETA to use for each waypoint. To enter the Time and Date, click the [Date] window to show the [Set date] window. Click the appropriate date. The date entered appears in the [Set ETA] window.

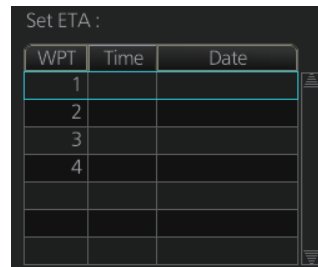

WPT	Time	Date
1		
2		
3		
4		

4. Click the [Calculate] button to calculate optimal route. The [Optimized Speed/ETA] dialog box shows the results of the calculation.

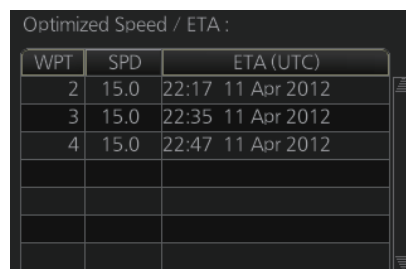

WPT	SPD	ETA (UTC)
2	15.0	22:17 11 Apr 2012
3	15.0	22:35 11 Apr 2012
4	15.0	22:47 11 Apr 2012

5. To apply the information to the route, click the [Apply to Route] button.
 6. To save all optimization settings, click the [Save] button.
 Note that the ETA used in route reports is the first-entered ETA.

12.8.3 How to plan a speed profile

A speed profile is defined by general max. speed and optimization types. These values are given while planning a route. You can define speed limit and optimize type in the [Optimize] page of the [Route Plan] dialog box and in the [Waypoints] page you can give planned and max. speed for each leg. The table below demonstrate how different optimize types and speed limits influence speed.

WPT	MIN cost	MAX profit	Time table	MAX speed
1	4.8	10.9	10.0	10
2	4.8	12.9	15.0	15
3	4.8	12.9	16.2	20
4	4.8	12.9	16.2	20
5	6.0	12.9	15.0	15
6	6.0	12.9	16.2	20
7	4.8	12.9	16.2	20
8	4.8	12.9	16.2	20
9	6.0	12.9	16.2	17
10	4.8	8.0	8.0	8

12.9 How to Import Routes

12.9.1 How to import FMD-3x00, FCR-2xx9, FAR-3xx0 route data

You can import a route created on another FMD-3x00, FCR-2xx9, FAR-3xx0.

1. Set the USB flash memory that contains the route data to import in the USB port on the Control Unit.
2. Click the  button on the Status bar and select [Settings]. The confirmation message appears.
3. Click the [OK] button.
4. Click the [File Import] tab.

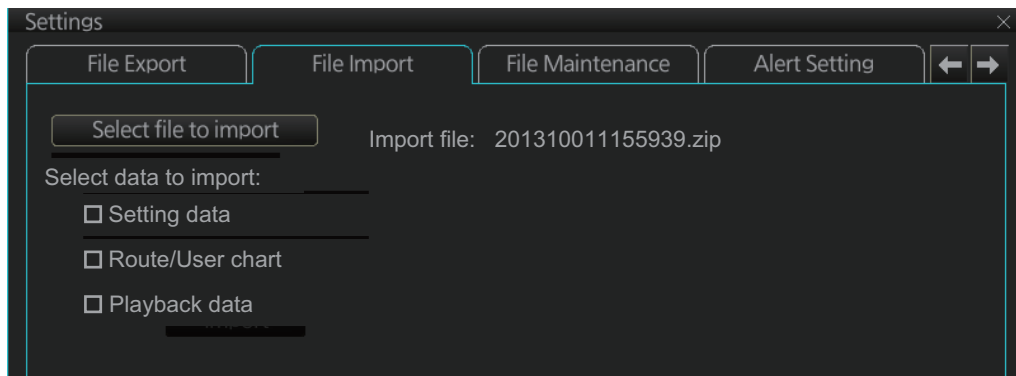

5. Click the [Select file to import] button to select the file to import.
6. Check the data to import, at [Select data to import].
7. Click the [Import] button.

12.9.2 How to import FEA-2x07 route data

Routes created at an ECDIS FEA-2x07 can easily be imported to this ECDIS. Copy the routes to a folder in a USB flash memory then follow this procedure. Note that FEA-2x05-created routes cannot be imported.

1. Set the USB flash memory to the USB port on the Control Unit.
2. Activate the Voyage planning mode.
3. On the InstantAccess bar™, click the [Manage Data], [Data Import] and [Route] buttons to show the [SELECT DIRECTORY] dialog box.
4. Select the folder that contains the route(s) to be imported then click the [OK] button.
5. Check the route(s) to import then click the [Import] button.

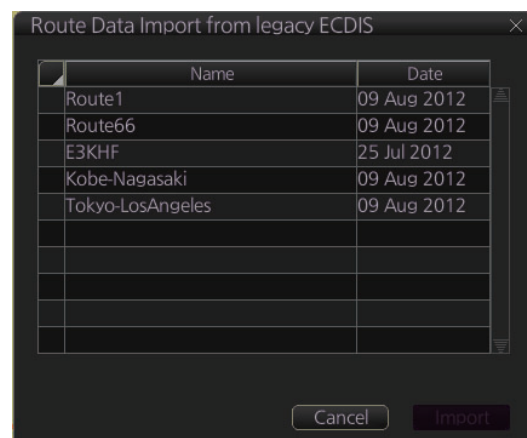

12.9.3 How to import RTZ, CSV, ASCII format route data

1. Set the USB flash memory to the USB port on the Control Unit.

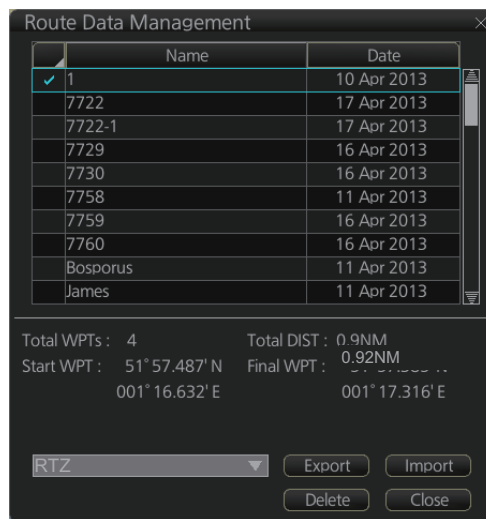

2. Activate the Voyage planning mode.
3. On the InstantAccess bar™, click the [Manage Data], [Route] and [Route Data Management] buttons to show the [Route Data Management] dialog box.
4. At the drop-down list, select the import format. The choices are
 - [RTZ]: route data, XML format
 - [FEA-2x07]: route data, ECDIS FEA-2x07 format
 - [CSV Position]: waypoint position data, CSV format
 - [ASCII WPT Name Position]: waypoint name, position order, ASCII format
 - [ASCII Full]: all route data, ASCII format
 - [ASCII Full (Support Asymmetrical XTD Limit)]: asymmetrical channel limit support, ASCII format
 - [CSV Route Sheet]: route data, CSV format
 - [RTE Format]: route data, RTE format
5. Click the [Import] button.
6. Select the file to import then click the [Open] button.
7. Click the [Close] button to close the dialog box.

12.10 How to Export Route Data

12.10.1 How to export FAR-3xx0 route data

You can export route data to share the data with other FMD-3x00, FCR-2xx9 or FAR-3xx0 units.

1. Set a USB flash memory in the USB port on the Control Unit.
2. Click the  button on the Status bar and select [Settings]. The confirmation message appears.
3. Click the [OK] button.
4. Click the [File Export] tab.

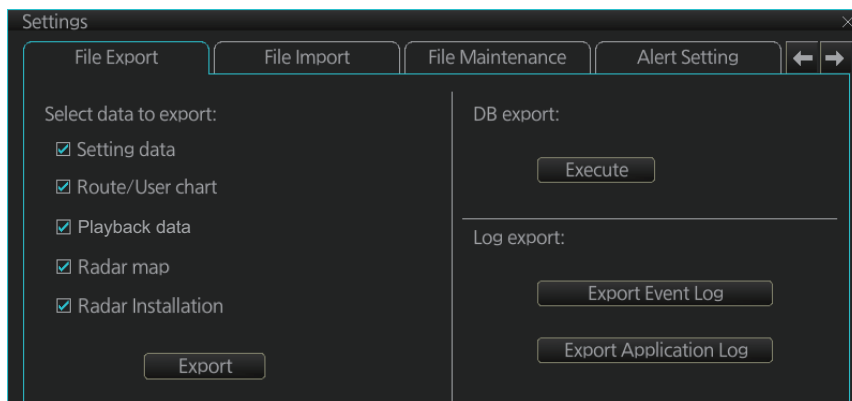

5. At [Select data to export], check only [Route/User chart].
6. Click the [Export] button to save the data to the USB flash memory.

12.10.2 How to export route data in RTZ, CSV, ASCII format

1. Set the USB flash memory to the USB port on the Control Unit.
2. Activate the Voyage planning mode.
3. On the InstantAccess bar™, click the [Manage Data], [Route] and [Route Data Management] buttons to show the [Route Data Management] dialog box.
4. At the drop-down list, select the import format. The choices are
 [RTZ]: route data, XML format
 [CSV Position]: waypoint position data, CSV format
 [ASCII WPT Name Position]: waypoint name, position order, ASCII format
 [ASCII Full]: all route data, ASCII format
 [ASCII Full (Support Asymmetrical XTD Limit): Asymmetrical channel limit support, ASCII format

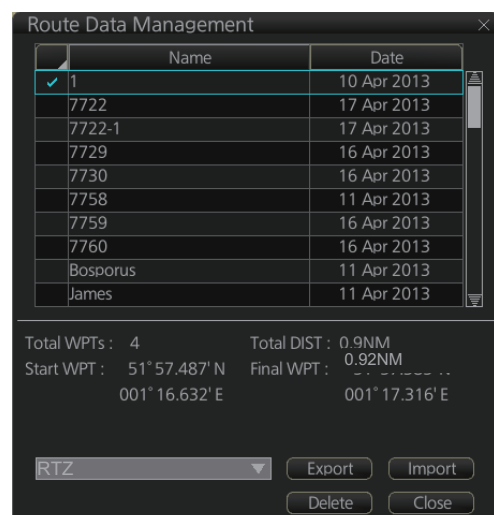

5. Check the route(s) to export then click the [Export] button.
- Note:** When route transfer is enabled [Route transfer (LAN)] appears in the drop-down list, but is not selectable (see section 12.13).

6. Select the destination to save the exported data.
7. Click the [OK] button.
8. Click the [Close] button to close the dialog box.

12.11 How to Delete Routes

1. Click the [PLAN] button on the Status bar to get into the Planning navigation mode.
2. Click the [Manage Data] button on the InstantAccess bar™ followed by the [Route] button.

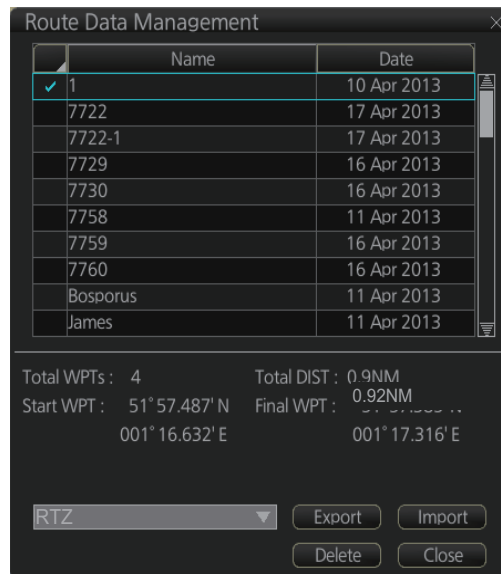

3. Put a checkmark in the check box to the left of the route name.
4. Click the [Delete] button. The confirmation message appears.
5. Click the [OK] button.
6. Click the [Close] button to close the dialog box.

12.12 How to Transfer Routes

The route transfer feature lets you send and receive route data (RRT sentence) among the units connected in the LAN. Information about transmitted and received route data is stored in the route transfer log (see section 19.6).

Note: This feature is not available with our FAR-2xx7 or FAR-2xx8 series radars. When you start monitoring a route, the route will be automatically sent to the radar connected in the network, regardless of the setting of this function.

12.12.1 How to turn route transfer on/off

To turn the route transfer feature on or off, do the following:

1. Open the menu, then click [Shared] and [Route Transfer] to show the following dialog box.

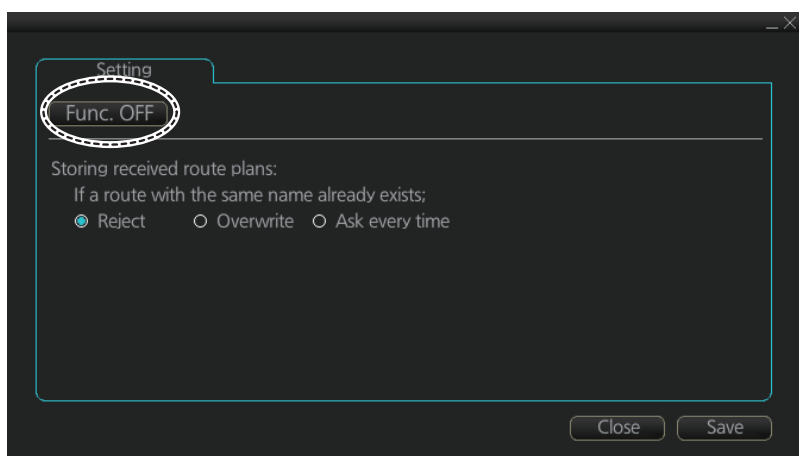

2. Click the function button (circled in the figure above) to change its label to read [Func ON] (route transfer is enabled) or [Func. OFF] (route transfer is disabled) as required.
When route transfer is enabled, the following functions are also enabled:
 - Send/receive monitored routes
 - Send/received planned routes
3. Use the radio buttons to select what to do when receiving route data having the same name as existing route data - [Reject], [Overwrite], [Ask every time].
 - [Reject]: Don't save received route data. When route data is being received, a pop-up message informs you that the data will not be saved.
 - [Overwrite]: Previously existing route data is written over. No notification of the overwriting is given.
 - [Ask every time]: The [Route Transfer] dialog box appears. Click applicable button, referring to the description below.

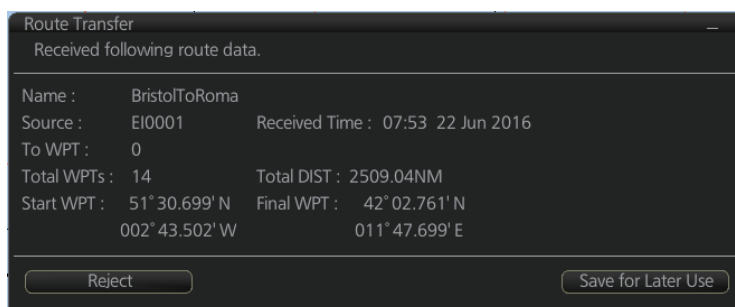

- [Reject]: Route data is not saved.
 - [Save for later use]: Route data is saved. (You can write over existing route data or save received route data under a new name.)
4. Click the Save button to save your settings, then click the close button to finish and close the window.
- With route transfer selected to ON, the option [Route Transfer (LAN)] is added to the drop down list box in the [Route Data Management] dialog box.

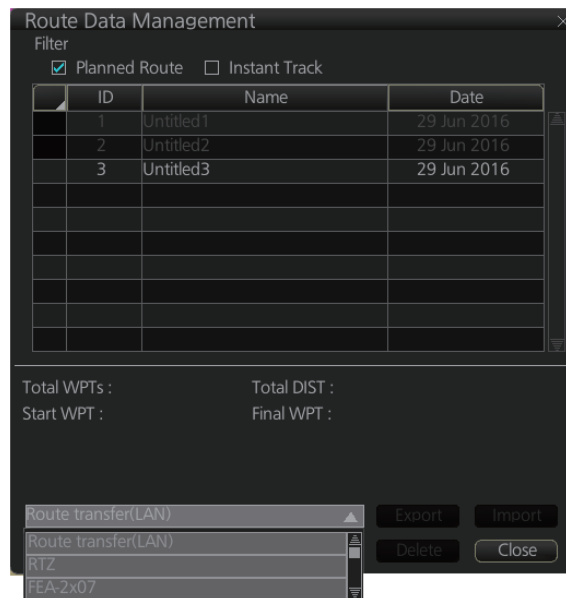

12.12.2 How to send and receive monitored routes

Sending monitored routes

The ECDIS mode sends the route data for a route which is selected for monitoring to other equipment with the ECDIS mode enabled and connected to the same network. This is done automatically when route transfer is enabled and route monitoring is initiated.

Receiving monitored routes

When a route is received from another unit with the ECDIS mode enabled and on the same network, the [Route Transfer] window appears.

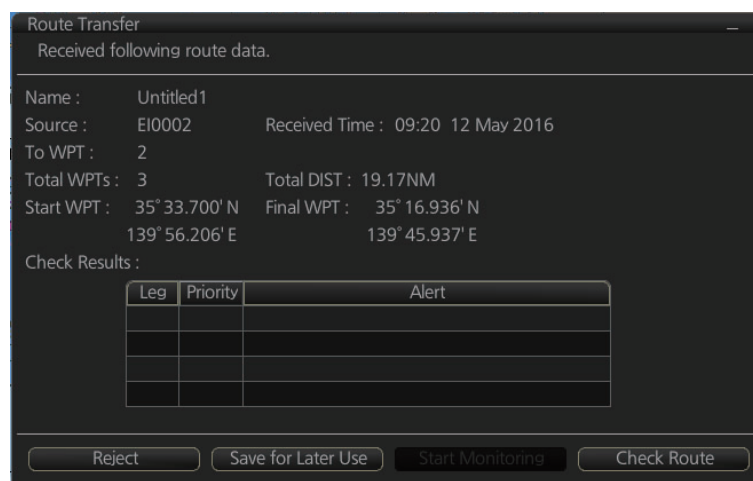

12. ROUTES

Select the appropriate handling for the received route from the buttons at the base of the [Route Transfer] window.

- [Reject]: Route data is not saved.
- [Save for later use]: Route data is saved. (You can write over existing route data or save received route data under a new name.)
- [Start Monitoring]: Moves the received route to the Route Monitor. This button is not selectable until the route is checked.
- [Check Route]: Check route for safe navigation. The results are shown the [Check Results] page. After the check is complete, the [Start Monitoring] button becomes selectable.

12.12.3 How to send and receive planned routes

Sending a planned route

You can send a planned route to other units with the ECDIS mode enabled and in the same network.

1. Click the [PLAN] button on the Status bar to get into the Voyage planning mode.
2. On the InstantAccess bar™, click the [Manage Data] and [Route] buttons to show the [Route Data Management] dialog box.
3. Place a check in the box to left of the route(s) to transfer, then select Route transfer (LAN) from the drop-down box.
4. Select [Export].
The selected route(s) are transferred to the units with the ECDIS mode enabled and connected to the same network.

Note: If route transfer fails, the message "No response of route transfer. Please try again route transfer." appears. Check connections, then retry the above procedure.

Receiving a planned route

When a planned route is received with same name as an existing route, it is handled in the manner set at step 3 of section 12.12.1.

For all other received routes, the system automatically saves the route.

12.13 Reports

This chart radar generates reports for waypoints in the selected route. If connected to a printer, reports can be printed by clicking the [Print Text] button. Text in reports can be searched with the [Find] button.

To generate a report, do the following:

1. Click the [Plan] button to go to the Voyage planning mode.
2. Click the [Report] button followed by the [Route] button. Click applicable “report” button.



The following dialog box appears.

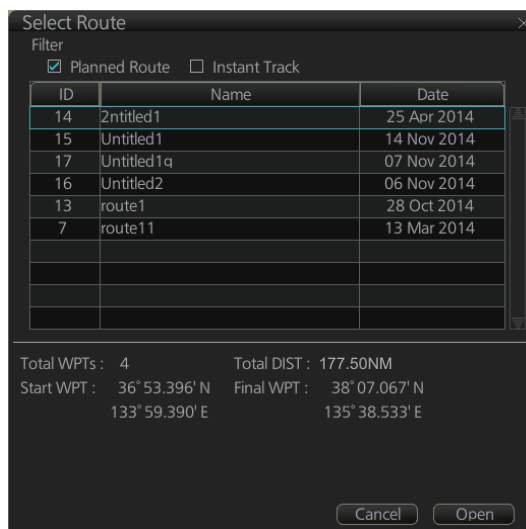

3. Select the appropriate route then click the [Open] button to show the selected report. See the next several pages for examples.

WPT table report

The WPT report contains the following information:

- Route name
- Date of report
- Waypoint no.
- Length of waypoint
- Distance remaining in route
- Position in latitude and longitude
- Planned courses and steering methods (RL (RhumbLine), GC (GreatCircle))
- Turning radius
- Planned speeds
- Estimated times of arrival (ETA)
- ETD from waypoint 1 (start point)
- ETA to waypoint "x" (final waypoint)
- Total length of route
- Estimated time required to run route using planned speeds and courses

Route Planning Report

Route Name : FEA-ROUTE-WPTNAME-FINLAND
 Report Date : 02:41 23 Apr 2013

WPT	Name		HFO		DO				
	LAT	LON	Length	Remain	CRS	M	RAD	SPD	ETA
1 "A "	34° 41.169'N	135° 19.531'E	(N/A)		37.0	(N/A)	(N/A)	(N/A)	(N/A)
2 "A "	34° 35.408'N	135° 19.468'E	5.8		31.3	180.5	RL	0.80	22.0
3 "O "	34° 34.995'N	135° 15.729'E	3.1		28.1	262.4	RL	0.80	22.0
4 "AO "	34° 34.761'N	135° 09.423'E	5.2		22.9	267.4	RL	0.80	22.0

Full WPT report

You can generate a full waypoint report for the route selected. The report includes the following for each waypoint.

- Route name
- Date of report
- Waypoint no.
- Position in latitude and longitude
- Planned radius
- XTD (Channel) limit (If set individually, port and starboard channel limits are separated with a diagonal.)
- Planned speed
- Planned course
- ETA
- Time difference from UTC
- Steering mode (rhumb line or great circle) to each waypoint
- ROT
- Margin for channel limit
- Speed Max
- Leg length
- Time used

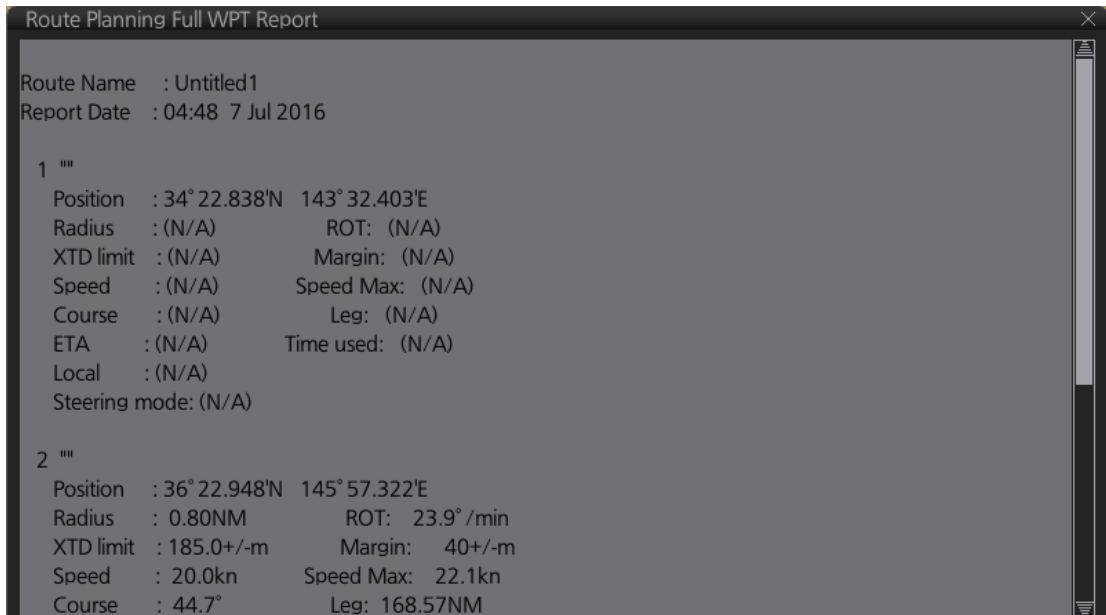

12. ROUTES

Passage plan report

The passage plan report generates waypoint information for each waypoint in the route selected.

- Route name
- Date of report
- Waypoint no.
- Position in latitude and longitude
- Length
- Cumulative length
- Planned course
- Steering method (RL or GC)
- Name of waypoint

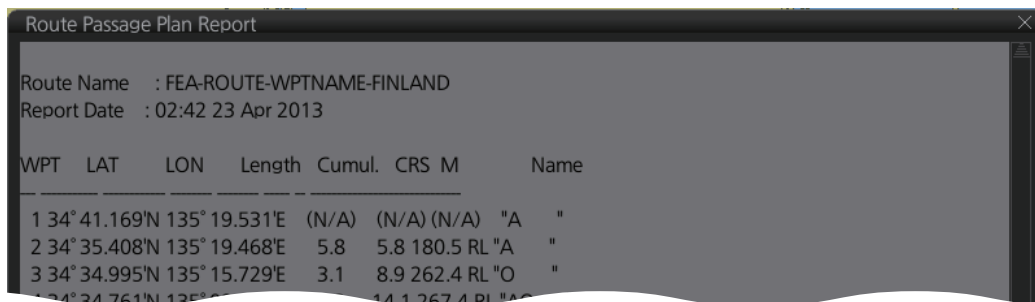

Route Passage Plan Report

Route Name : FEA-ROUTE-WPTNAME-FINLAND
Report Date : 02:42 23 Apr 2013

WPT	LAT	LON	Length	Cumul.	CRS	M	Name
1	34° 41.169'N	135° 19.531'E	(N/A)	(N/A)	(N/A)	"A	"
2	34° 35.408'N	135° 19.468'E	5.8	5.8	180.5	RL "A	"
3	34° 34.995'N	135° 15.729'E	3.1	8.9	262.4	RL "O	"
4	34° 34.761'N	135° 15.729'E		14.1	267.4	RL "A	"

13. USER CHARTS

13.1 Introduction

User charts are overlays that the user creates to indicate safety-related objects and areas. They can be displayed on both the radar display and the electronic chart. These charts are intended for pointing out safety-related items like position of important navigation marks, safe area for the ship, etc. User charts areas can be used to activate alerts and indications based on user-defined danger symbols, lines and areas. When route or own ship estimated position is going to cross a user chart symbol, line or area that is defined as a dangerous one, an alert or indication is generated by the system. See the chapter on chart alerts.

A user chart consists of various objects (points, lines, text, symbols, etc.). The maximum number of points per user chart is 300 (a circle is one point, a rectangle is four points). You may link up to five user charts to a route, for a max. of 1,500 user chart points per route.

The user chart is displayed on the radar display and its position and shape is based on the ship's actual position. When own ship is moving in the area covered by the user chart, the elements of the user chart are superimposed on the radar, with a maximum of 80 of the nearest elements displayed.

13.1.1 Objects of user charts

Below is a description of the objects used in a user chart.

- **Tidal:** There are two types of tidals, current and predicted.
- **Line:** You can define four different types of lines. Lines can be used in chart alert calculation and/or display on the radar:
 - **Navigation lines:** Displayed on both the radar display and the chart display. Navigation lines are reference lines for coast line.
 - **Coast line:** Displayed on both the radar and the chart display. Coastal line is usually a well-defined (by chart digitizer) multi-segment line showing the coastline. The user is able to create this type of line in case there is no suitable chart available over desired area in S57 format.
 - **Depth contour:** Displayed on both the radar and chart display. Depth line shows the chosen depth levels. The user is able to create this type of line in case there is no suitable chart available over desired area in or S57 format.
 - **Route line:** Displayed on both the radar display and the chart display. Route lines are zones for anchoring, traffic separation lines, etc.
- **Clearing line:** A clearing line is used to define a line which a vessel can sail to avoid navigational hazards. A clearing line can be of the NMT (Not More Than) or NLT (Not Less Than) type. Displayed on the chart display only.
- **Area:** The operator can define closed areas, which the system can use to detect safe water areas. If route or estimated ship position is going to cross the area, the system generates a warning to the user. These areas can be used to specify safe

areas as defined by the master or by the policy of the ship's owner. They are always available regardless of the type of chart material used.

- **Circle:** The operator can define an area with a circle, which can define a location to avoid. If route or estimated ship position is going to cross the area, the system generates a warning to the user. These areas can be used to specify safe areas as defined by the master or by the policy of the ship's owner. They are always available regardless of the type of chart material used.
- **Label:** There are two types of labels: point and label. A "point" (i) is mainly used to denote position of objects, such as buoys, light houses, fixed targets, wrecks, etc. Points can be used in chart alert calculation. A "label" provides user-entered text to show on the display.

13.2 How User Charts are Synced

User chart data can be shared between this ECDIS and other like units (FMD-3x00, FCR-2xx9 or FAR-3xx0), through the LAN. A minimum of two units is required. Turn on all units beforehand to enable syncing. The sync source (master unit) is automatically assigned by the system when each unit is powered. For configurations with three or more units, two units are assigned as a sync source and have priority regardless of their power status (ON or OFF). The priority is assigned as follows:

- 1) ECDIS unit assigned as the Planning ECDIS.
- 2) ECDIS unit assigned with the lowest unit number at installation.
- 3) CHART RADAR unit assigned with the lowest unit number at installation.

Be aware that if a unit is turned off, some user chart data may be deleted. Two examples are shown below.

Using ECD001 and ECD002

This example assumes that ECD002 is assigned as a Planning ECDIS.

1. ECD002 is off; ECD001 is powered and a user chart is created at ECD001. Even though ECD002 is the Planning ECDIS, user chart data is not transferred to ECD002 because the power is turned off.
2. ECD002 is turned on. As this unit is assigned as a Planning ECDIS, ECD001's user chart data is deleted.

Using ECD001, ECD002 and CRA001

This example assumes that ECD001 and ECD002 is assigned as a Planning ECDIS.

1. ECD001/002 are both turned off; CRA001 is powered and a user chart is created on CRA001. user chart data is not transferred as both ECD001 and ECD002 are turned off.
2. ECD001 is turned on. As this unit is assigned as a Planning ECDIS, CRA001's user chart data is deleted.

If the operator clicks the PLAN button on the Status bar when one or more units (including the master unit) is turned off, one of the following messages appears.

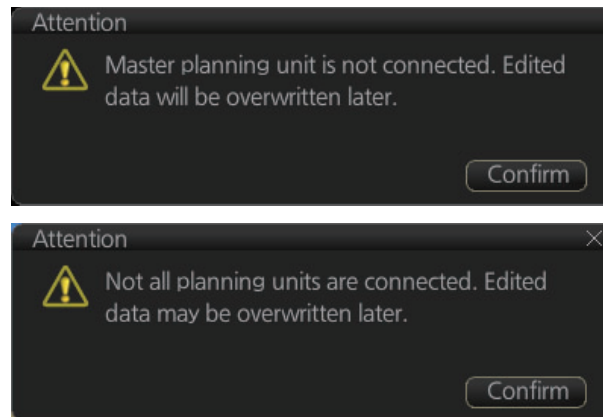

Turn all units in the same network on, then plan or edit the user chart as required.

13.3 How to Create a User Chart

You can create and modify a user chart in the Voyage planning mode.

To make a complete user chart, do the following:

1. Click the [PLAN] button on the Status bar to go to the Voyage planning mode.
2. Click the [Planning] and [User Chart] buttons on the InstantAccess bar™ to show the user chart palette and the [User Chart] dialog box.
3. Click the [New] button on the [User Chart] dialog box to create a new chart.

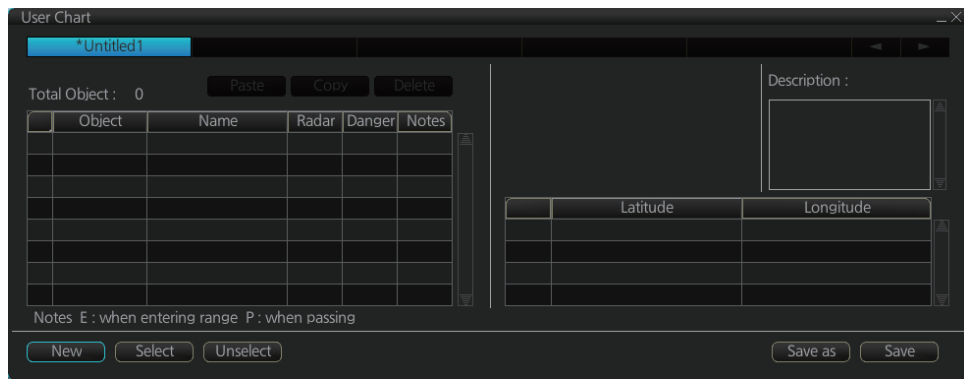

4. Click the desired object (button) on the palette. The [Tidal], [Line], [Clearing line] and [Label] buttons have multiple choices. Right-click the respective button to show a context sensitive menu. The choices available for each object are shown below.

Tidal: Current, Predicted

Line: Coast, Nav, Route, Depth

Clearing line: NMT (Not More Than), NLT (Not Less Than)

Label: Label, Point

5. Put the cursor on the location to insert the object then push the left button. See the figure below for how to construct lines, areas and circles. For the “Tidal” object, you can set Orientation, Strength and Time from the dialog box. With the “Label” object you can enter text and show that text on the screen.

Note: An object can also be put at the center of the screen. Do steps 1-4 in this procedure. On the [User Chart] dialog box, right-click the box to the left of [Object] then select [Add Object] from the pop-up menu.

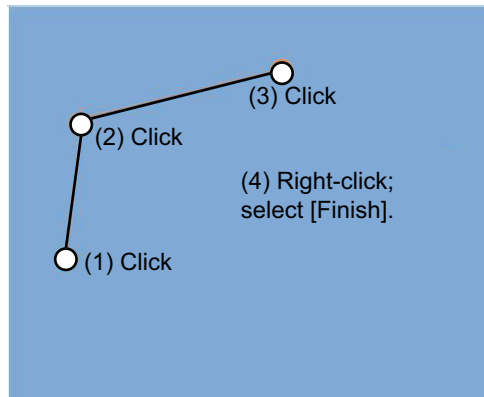

How to create a line

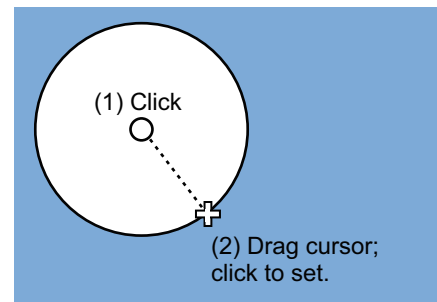

- 1) Put cursor where to locate center of circle then click.
- 2) Drag cursor to set radius; click to set.

How to create a circle

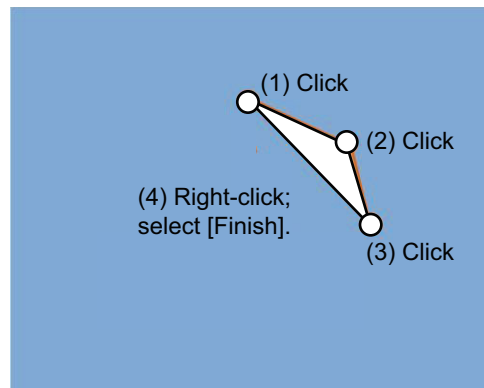

How to create an area

6. When you insert an object, the following is done in the [User Chart] dialog box:
 - Name of the object button appears in the [Object] window
 - Latitude and longitude position of the object is displayed
 - Total object count is updated
7. To enter a name for the object click the appropriate location in the [Name] window then use the software keyboard on the Control Unit to enter a name.

Note: The name entered for circles and areas can be shown inside the area or circle on the screen. For details, see page 8-10.
8. To show the object on the radar display, click the corresponding box in the [Radar] window to show a checkmark in the box.

For the label, line, clearing line, area and circle, click the corresponding box in the [Danger] window to use or don't use the object in chart alert calculation. Show a red checkmark to use the object in chart alert calculation.

For the area, circle and line, you can add Notes as shown below. See the description and figure below for a description of Notes.

 - 1) Enter the text for the Notes in the [Description] box.
 - 2) Click the box in the [Notes] window of the [User Chart] dialog box to set the message indication.
 - [E] (entering): Shows the message when the own ship enters into the objects (area or circle). For line setting, shows the message when the own ship reaches range that is defined in the [Range of notes] menu, from the position of setting in the [Notes].
 - [P] (passing): Shows the message when the own ship runs over 10 NM in the objects (area or circle).
 - Empty: Shows nothing.

- 3) At the [Range of notes] (shown only for line) input box, enter the distance from the Notes position at which to display the Notes.

Note: You cannot select both [Danger] and [Notes] for these symbols; select either [Danger] or [Notes].

What are Notes?

“Notes” provide, in the Voyage navigation mode, messages for the operator relative to your vessel’s position. When own ship is x miles from an area or circle chart object, a message appears in the [Monitor Note] dialog box. The message appears for a line (set in [Range of notes]) when own ship is within x miles of the line or x miles after passing the line.

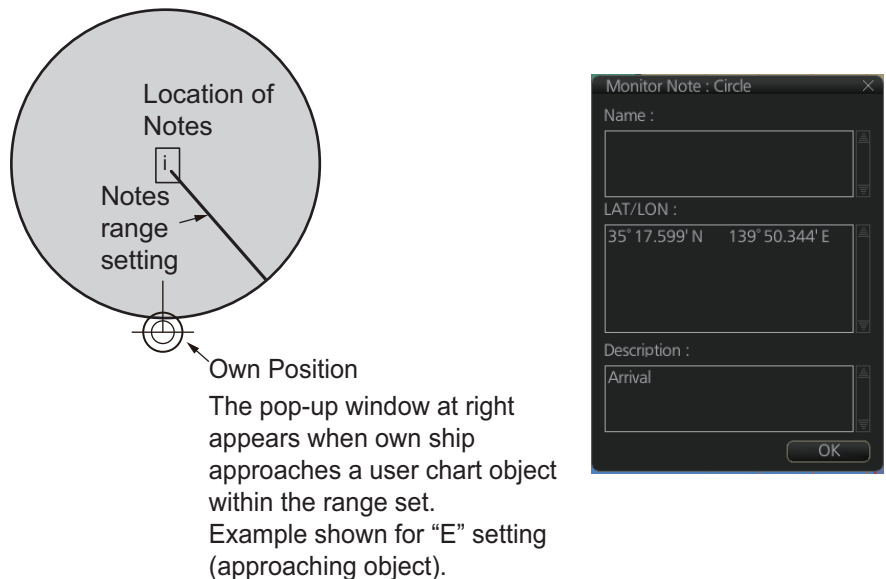

9. To continue entering the same symbol, click a new location on the screen and do step 3. To enter a different symbol, do steps 3 and 4.
10. After you have entered all necessary objects, click the [Save] button.

Note: If the [Save] button is not shown, update the user chart to show the button.
11. The [Save user chart] window appears. Enter a name for the user chart and comments then click the [Save] button.

The figure on the next page shows a user chart and the corresponding entries in the [User Chart] dialog box.

- The Line with the name "Coast" is a coastline.
- The Circle has the Notes "E" which means the message set in the [Description] box when the own ship enters the circle will be shown.
- The Tidal marks line marks a tidal (current).
- The Area has Radar and Danger checked. This means the area is shown on the radar display and is used in chart alert calculation.
- The Label with the name "Point No. 1" is a point label and is also shown on the radar display.
- The Label with the name "Wreck" is a common label and has Danger checked; it is used in chart alert calculation.

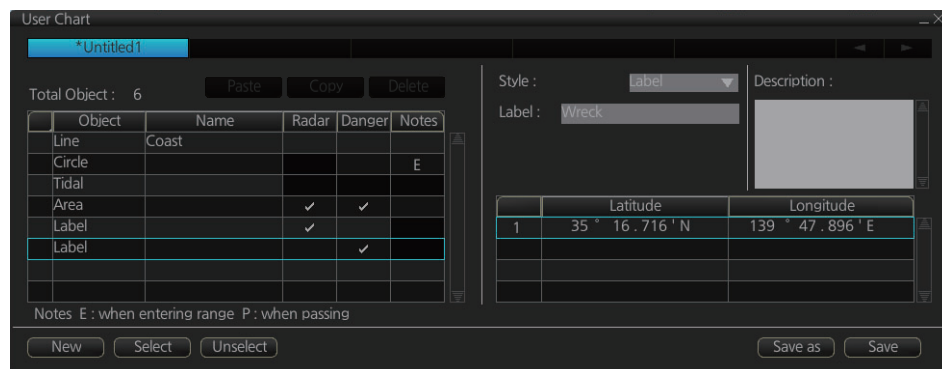
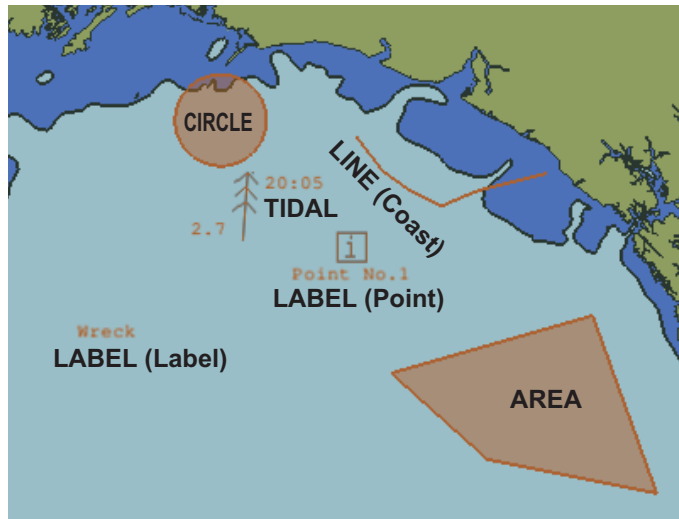

How to use the Undo feature

The Undo feature, available when creating a route and a user chart, can be accessed from the [UNDO] button on the InstantAccess bar™, use double-click, or the context-sensitive menu. In user chart creation the feature is used with object and text input as follows:

Tidal, Circle, Current, Label: Delete last-entered object.

Area, Line: Erase last-entered point. For [Area], the area must have at least four points. And for a [Line], there must be at least three points.

Text input: Erase last-entered character or character string.

13.4 How to Edit Objects on a User Chart

User chart object locations and names can be edited using the procedure below.

1. Referring to step 1 and step 2 in section 13.3, show the [User Chart] dialog box.
2. Click [Select] to show the [Select User Chart] dialog box.
3. Select the chart with objects to edit, then click [OK]. The selected chart's objects appear in the [User Chart] dialog box. The chart objects also appear on the currently displayed chart.
4. Edit the chart object information as required. You can also edit the objects on the chart display.

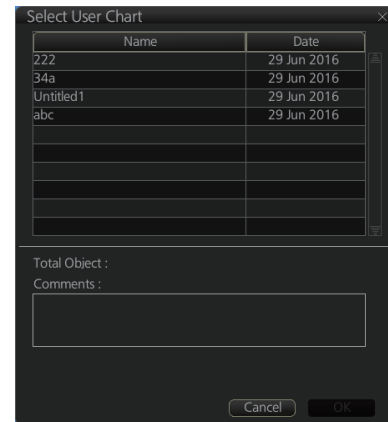

How to move objects

Drag and drop the object. For circles, polygons, etc, click the outer line of the area to drag and drop.

How to change corner points in lines and areas

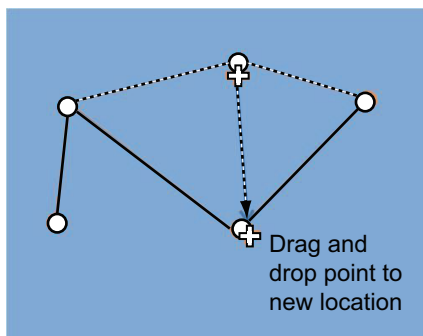

How to change corner point on a line

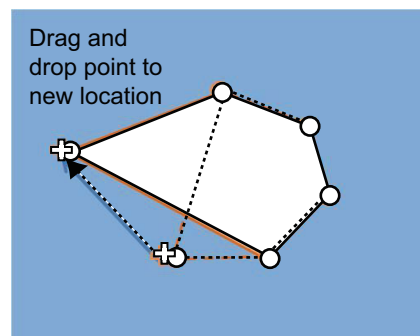

How to change corner point in an area

How to delete points in lines and areas

Place the cursor on the point to delete, right-click to show the context menu, then select [Delete]. The point is removed and the object is redrawn.

How to insert a corner point on a line or area

Put the cursor on the location where to insert a corner point, right-click the display area to show the context-sensitive menu then select [Insert].

Note: You can also insert a point from the [User Chart] dialog box with the following procedure.

- 1) Select the line or area from the [User Chart] dialog box.
- 2) At the bottom-right of the User Chart dialog, where the Latitude/Longitude appears, right-click the location for the new point. The context menu appears.
- 3) Click [Insert Before] or [Insert After] as required to insert a new point.
- 4) Adjust the latitude and longitude for the new point as required.
- 5) Click [Save] to save the changes and close the [User Chart] dialog box.

13.5 How to Delete Objects from a User Chart

You can delete objects from a user chart with the following procedure.

1. Referring to step 1 and step 2 in section 13.3, show the [User Chart] dialog box.
2. Click [Select] to show the [Select User Chart] dialog box.
3. Select the chart with objects to delete, then click [OK]. The selected chart's objects appear in the [User Chart] dialog box. The chart objects also appear on the currently displayed chart.
4. Click the box to the left of the object to delete. A check mark appears. You can select multiple objects in this manner.
5. Click the [Delete] button to remove the marked object(s).
Note: You can also delete an object from the context menu. Right-click the object to delete to show the context menu, then select [Delete].
6. Click [Save] to save the changes and close the [User Chart] dialog box.

13.6 How to Copy User Chart Objects

You can copy user chart objects from one chart (the "origin" chart), then paste them onto a different user chart ("destination" chart) with the following procedure.

1. Referring to step 1 and step 2 in section 13.3, show the [User Chart] dialog box.
2. Click [Select] to show the [Select User Chart] dialog box.
3. Select the "origin" chart, then click [OK].
4. Repeat step 2 and step 3 to select the "destination" chart.
5. On the [Select User Chart] dialog box, click the tab for the "origin" chart.
6. Check the box(es) for the object(s) you want to copy.
7. Click the [Copy] button.
8. On the [Select User Chart] dialog box, click the tab for the "destination" chart.
9. Click [Paste]. The objects selected at step 6 are copied to the chart.
10. Click [Save] to save the changes and close the [User Chart] dialog box.

13.7 How to Select the User Chart Objects to Display

User charts can be displayed on the electronic chart. Open the [Mariner] page in the [Symbol Display] menu and check the user chart items to display. Select the degree of transparency for the objects with [Density].

Note: Alpha blending technology is used for transparency effects.

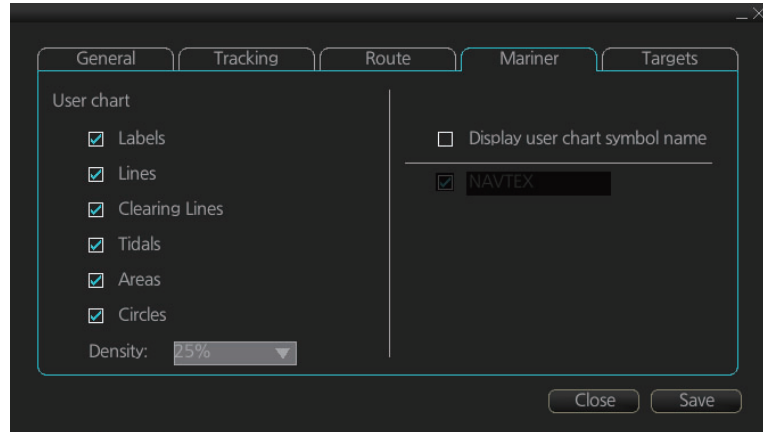

13.8 How to Import User Chart Data

13.8.1 How to import user chart data from other units

You can import user chart data from other units (FMD-3x00, FCR-2xx9 or FAR-3xx0) with the following procedure. For FEA-2x07 user charts, see section 13.8.2.

1. Set the USB flash memory to the USB port on the Control Unit.
2. Click the  button on the InstantAccess bar™, then select [Settings]. A confirmation pop up window appears.
3. Click OK to show the [Settings] menu.
4. Click the [File Import] tab, then click the [Select file to import] button. The open file dialog box appears.

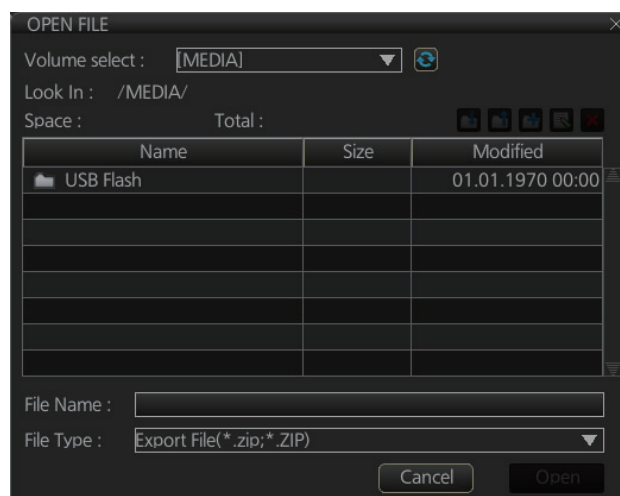

5. Select the file to import, then click the [Open] button. The open file dialog closes.

6. Click the box to the left of [Route/User chart] in the "Select data to import:" section of the [File Import] tab.
7. Click [Import].

13.8.2 How to import a user chart created with ECDIS FEA-2x07

User charts created at the ECDIS FEA-2x07 can easily be imported to this ECDIS. Copy the user charts to a folder (see chapter 17 in the operator's manual of the FEA-2x07) in a USB flash memory then do as follows. Note that FEA-2x05 created user charts cannot be imported.

1. Set the USB flash memory to the USB port on the Control Unit.
2. Activate the Voyage planning mode.
3. Click the [Manage Data], [Data Import] and [User Chart] buttons to show the [SELECT DIRECTORY] dialog box.

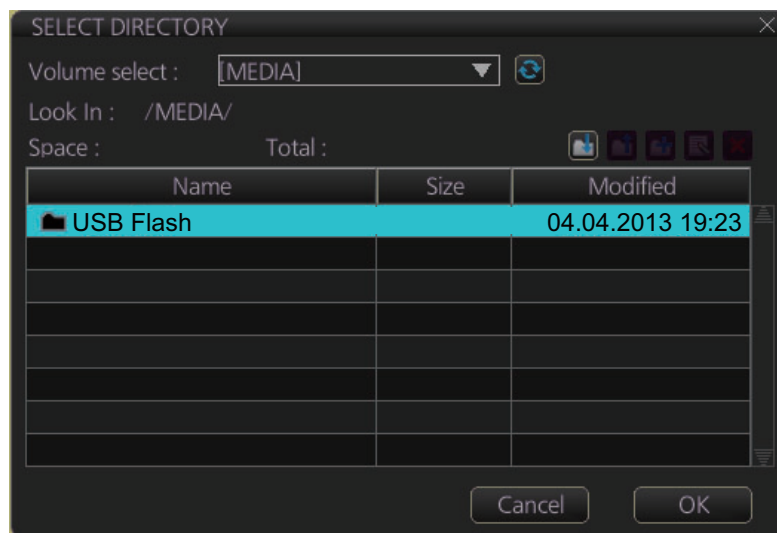

4. Select the folder that contains the user chart(s) to be imported then click the [OK] button.

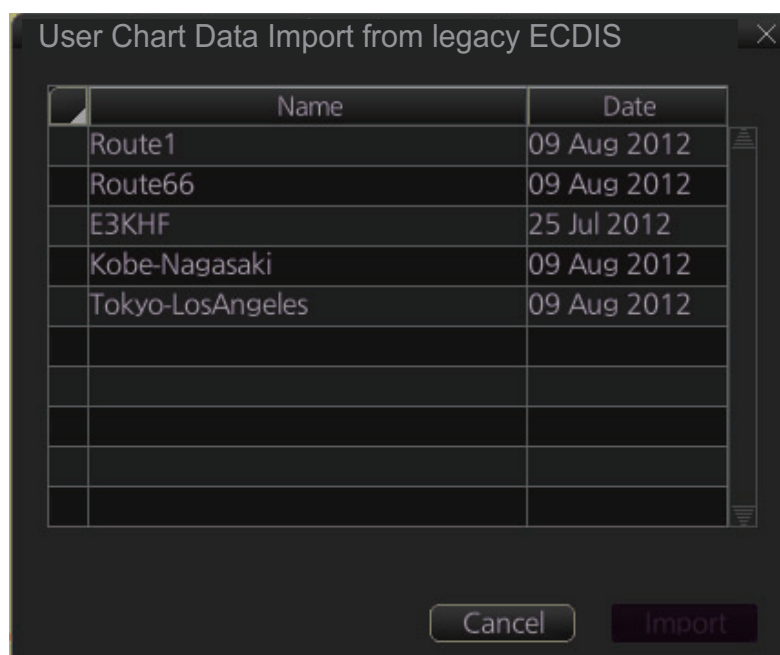

5. Check the user chart(s) to import then click the [Import] button.

13.8.3 How to import RTZ format user charts

1. Set the USB flash memory to the USB port on the Control Unit.
2. Click the [PLAN] button on the Status bar to go to the Voyage planning mode.
3. Click the [Manage Data] button on the InstantAccess bar™ followed by the [User Chart] button. The [User Chart Data Management] dialog box appears.
4. Click [Import]. The [SELECT DIRECTORY] pop up window appears.
5. Select the folder that contains the user chart(s) to be imported then click the [OK] button.
6. Check the user chart(s) to import then click the [Import] button.
7. Click [Close].

13.9 How to Export User Chart Data

You can save user chart data to a USB flash memory and share the data with other units (FMD-3x00, FCR-2xx9 or FAR-3xx0).

13.9.1 How to export user chart data created on the FMD-3x00

1. Set the USB flash memory to the USB port on the Control Unit.
2. Click the  button on the InstantAccess bar™, then select [Settings]. A confirmation pop up window appears.
3. Click OK to show the [Settings] menu.
4. Click the [File Export] tab.

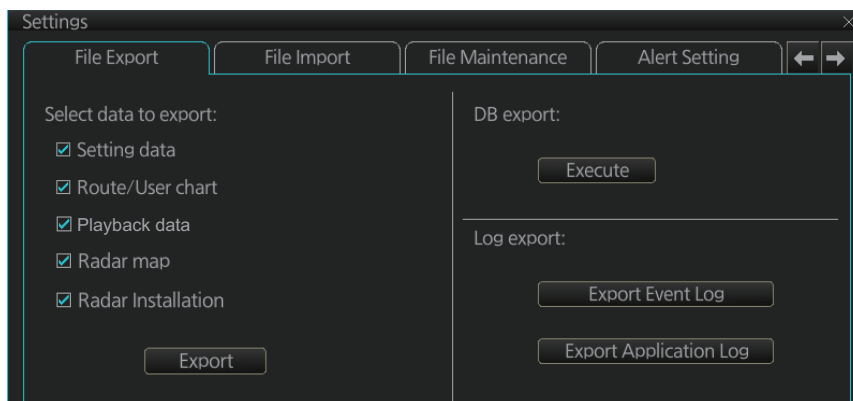

5. Check [Route/User chart], then click the [Export] button.

13.9.2 How to export RTZ format user chart data

1. Set the USB flash memory to the USB port on the Control Unit.
2. Click the [PLAN] button on the Status bar to go to the Voyage planning mode.
3. Click the [Manage Data] button on the InstantAccess bar™ followed by the [User Chart] button. The [User Chart Data Management] dialog box appears.
4. Check the user charts to export.
5. Click the [Export] button. The [SELECT DIRECTORY] pop up window appears.

6. Select the destination folder then click the [OK] button.
7. Click [Close].

13.10 How to Delete User Charts

1. Click the [PLAN] button on the Status bar to get into the Planning navigation mode.
2. Click the [Manage Data] button on the InstantAccess bar™ followed by the [User Chart] button.

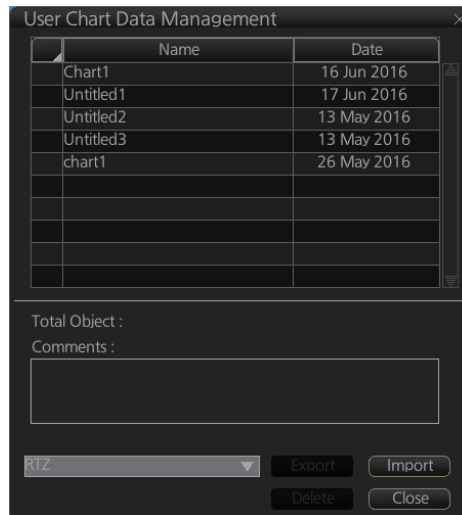

3. Check the user chart(s) to delete.
4. Click the [Delete] button.

13.11 User Chart Reports

1. Click the [Plan] button to go to the Voyage planning mode.
2. Click the [Report] button followed by the [User Chart] button to show the [Select User Chart] dialog box.

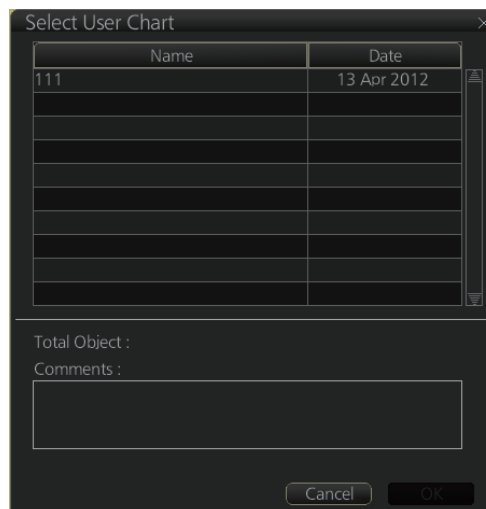

3. Select the appropriate user chart then click the [OK] button to show the selected report. See the next several pages for examples of reports.

13. USER CHARTS

Full report

The full report contains information about each tidal, line, clearing line, area, circle and label in the user chart selected. Check or uncheck the boxes at the top of the display to select the report(s) to display.

Check the report(s) to display.

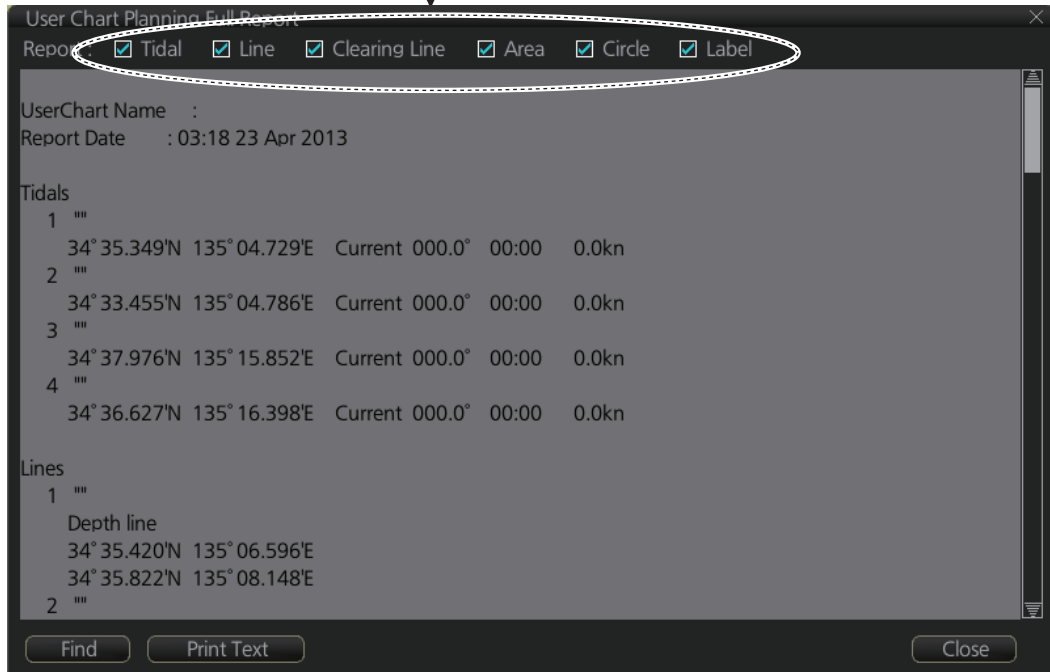

Tidal report

A tidal report provides:

- Position of the tidal
- Type of tidal (current or predicted)
- Speed and direction of the tidal
- Time of the tidal

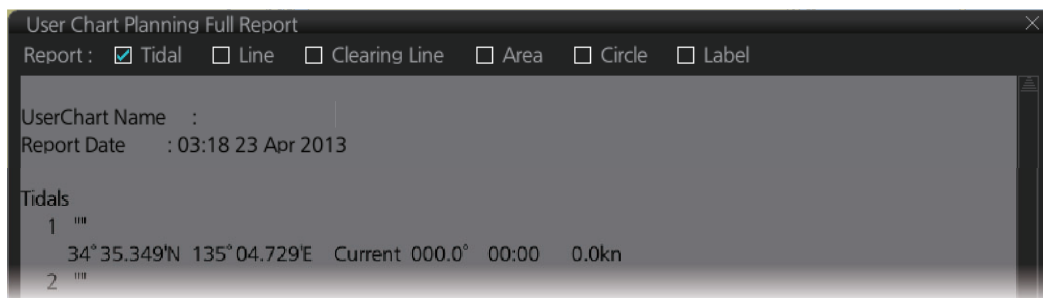

Line report

A line report provides:

- Line name
- Latitude and longitude position of each point on the line
- Where a check mark is input in the column for [Radar], [Danger] or [Notes] on the [User Chart] dialog box, "On Radar", "Danger" or "Has Notes" appears in the report.

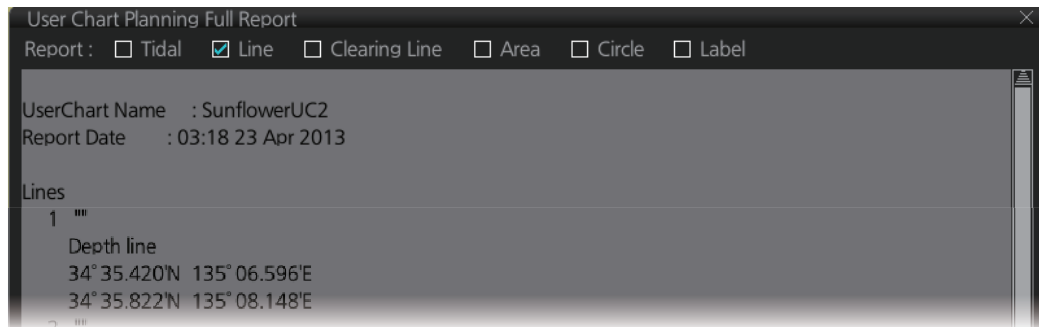

Clearing line

The Clearing line report shows the name and position of clearing lines entered on the chosen user chart selected.

- "On radar" is shown if the area is shown on the radar overlay.
- "Danger" is shown when a check mark is input in the column for [Danger] on the [User Chart] dialog box

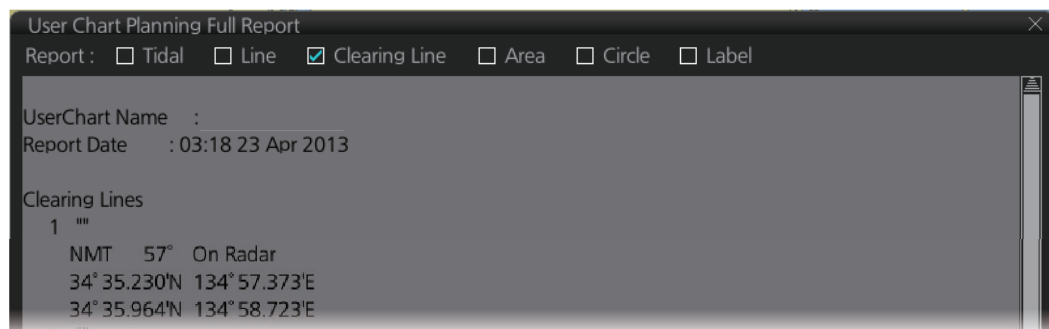

Area report

An area report provides:

- Area no. and area name
- The latitude and longitude position of each point of the area
- The description of the area
- Where a check mark is input in the column for [Radar], [Danger] or [Notes] on the [User Chart] dialog box, "On Radar", "Danger" or "Has Notes" appears in the report.

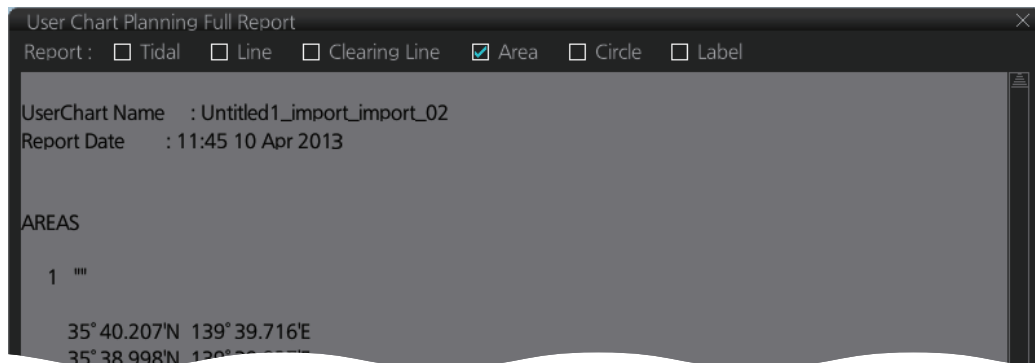
**Circle report**

The circle report provides:

- The position and radius of circles drawn on a user chart.
- Where a check mark is input in the column for [Danger] or [Notes] on the [User Chart] dialog box, "Danger" or "Has Notes" appears in the report.

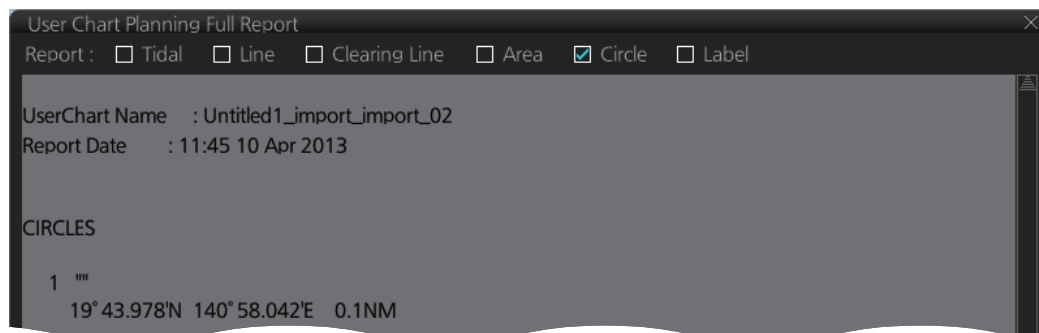
**Label report**

A label report provides:

- Latitude and longitude position of each label
- Name of each label
- Where a check mark is input in the column for [Danger] or [Notes] on the [User Chart] dialog box, "Danger" or "Has Notes" appears in the report.

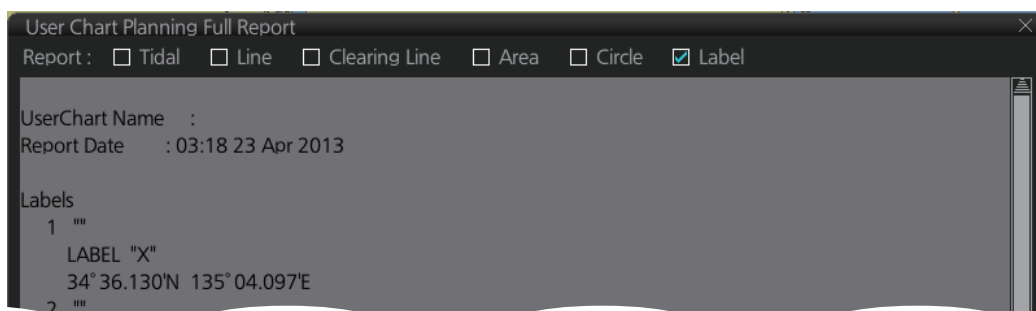

13.12 How to Select the User Chart(s) to Use in Route Monitoring

Do the procedure below to monitor a user chart without linking it to a route. Click the [NAVI] button on the Status bar then do as shown below.

1. Click the [Voyage], [User Chart] and [Select/Unselect] buttons on the InstantAccess bar™ to open the [Select Monitor User Chart] dialog box. The [Select Monitor User Chart] can also be selected by right clicking anywhere inside the [Route] information box (right side of screen) and then clicking [Monitor User Chart].

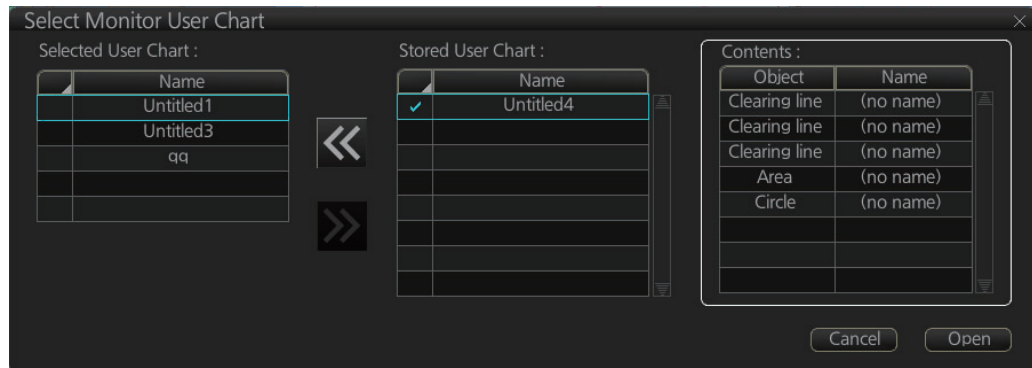

2. Check the chart(s) to use in the [Stored User Chart] window, then click the [<<] and [Open] buttons. The [Monitor Information] dialog box automatically appears, and shows the user charts selected for use in route monitoring. Click a user chart name to see details, in the [Contents] window.

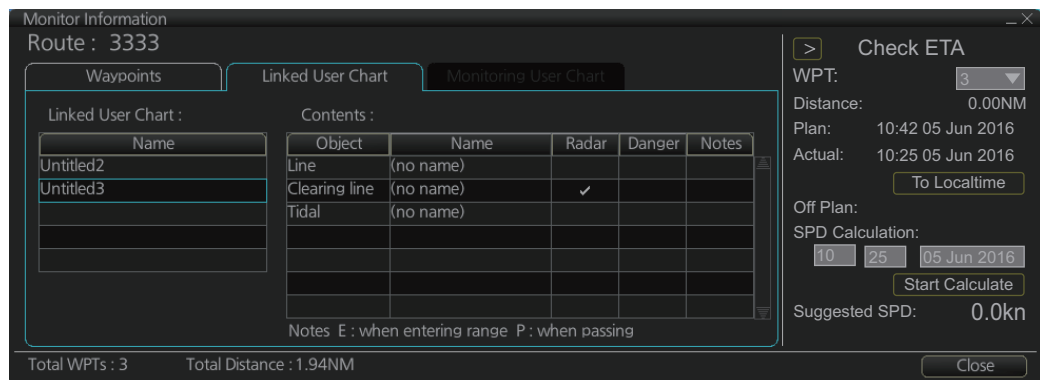

How to cancel use of a user chart during route monitoring

To cancel only a user chart during route monitoring, get into the Voyage navigation mode, then click the [Voyage], [User Chart], [Select/Unselect] buttons on the InstantAccess bar™ to show the [Select Monitor User Chart] dialog box. From the [Selected User Chart] list, select the user chart(s) to cancel, then click the [>>], and [Open] buttons.

To cancel both route and user chart in route monitoring, get into the Voyage navigation mode, then click the [Voyage] and [Stop Monitor] buttons on the InstantAccess bar™.

This page is intentionally left blank.

14. HOW TO MONITOR ROUTES

Route monitor is a means for permanent monitoring of the ship's behavior relative to the monitored route. The [Monitor Information] box displays the data on the ship's position relative to the monitored route. The monitored route consists of the following information, displayed in the electronic chart area:

- The route is displayed with red dots.
- The limits of channels of each leg are displayed with solid red lines. These limits are used to detect chart alerts when you are monitoring the route. See chapter 11 for how to set those limits.
- Each leg has information about planned speed, shown in the [Monitor Information] dialog box.
- Each leg has information about planned course to steer.

Note 1: In order to display charts with correctly updated situation, always use current date as Update Review and Display date during your voyage. If your voyage lasts more than one week, set current date at least once per week during your voyage. See section 9.2 for how to set those dates.

Note 2: XTD is the distance, in a straight line, from the monitored route to the CCRP. CCRP is set at installation. Where more than one CCRP is set, select the CCRP to use from the [CCRP] page of the [Settings] menu (see section 22.12).

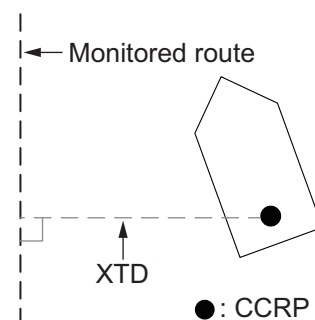

14.1 How to Start Route Monitoring

Method 1: InstantAccess bar™

In the Voyage navigation mode, click the [Voyage], [Route] and [Select] buttons on the InstantAccess bar™. Click a route then click the [Open] button.

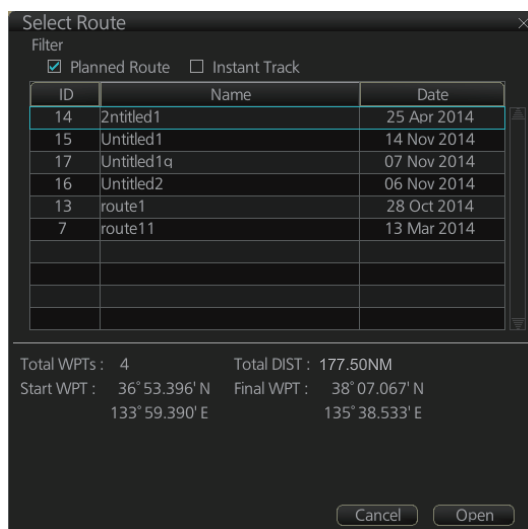

Method 2: Selection from the Route information box

Right-click the [Route Information] box to show the context-sensitive menu, then select [Select Route] to show the [Select Route] dialog box. Select a route then click the [Open] button.

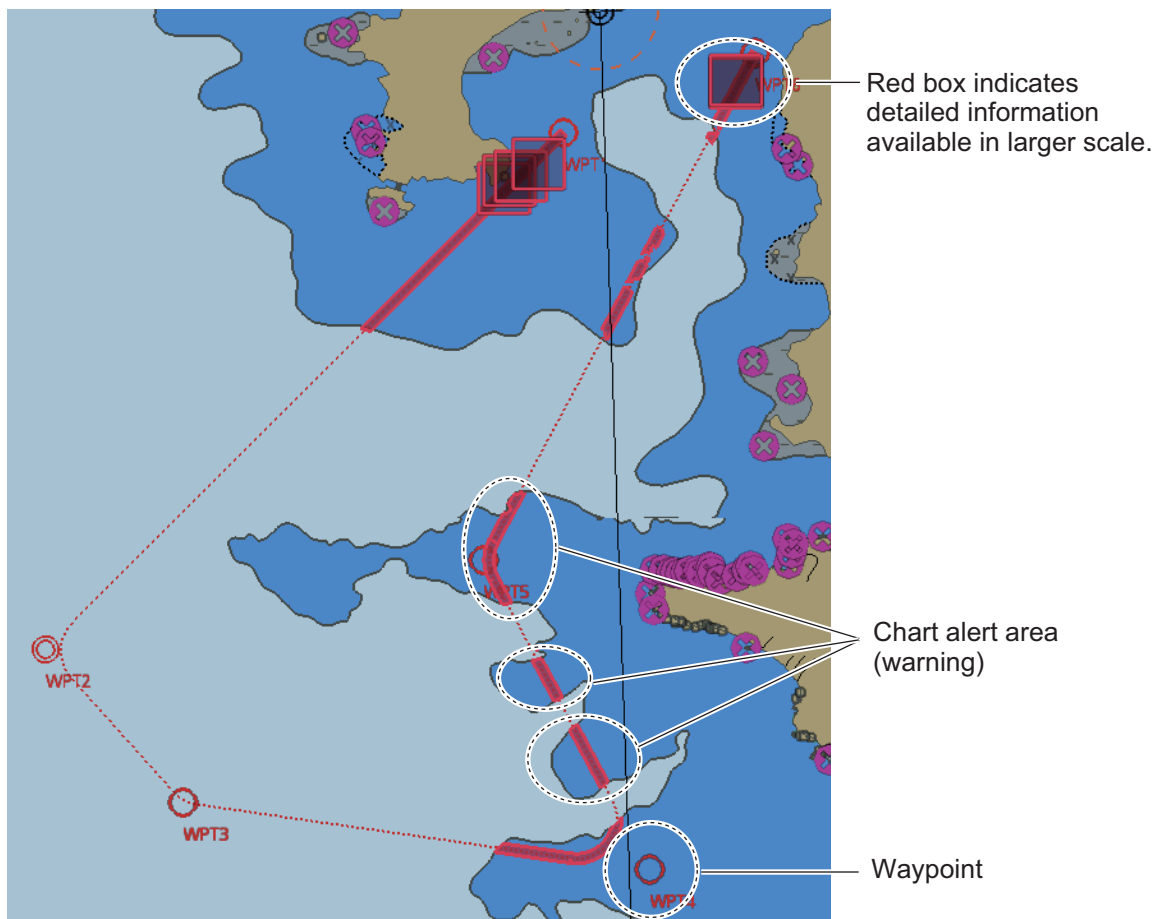
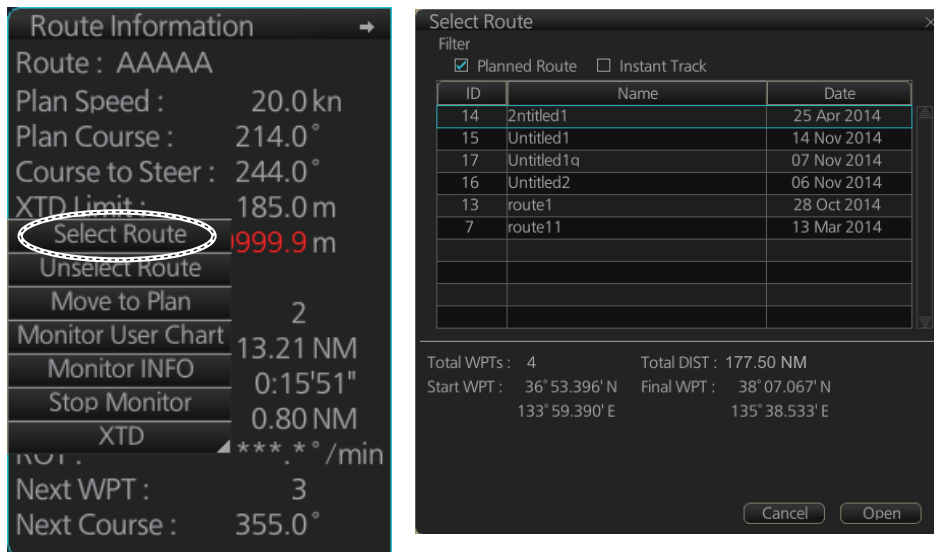

About monitoring routes

- When you select a route for monitoring, the messages shown below appear, on the [Select Route] dialog box or in a message window, when a route cannot be opened for monitoring.
 - "Impossible turn at WPT XX" (XX=waypoint no.). Geometry of the route makes it impossible for the ship to accomplish a turn. Modify the route to make the turn possible.
 - "Bad Leg WPT XX to WPT XX" (XX=waypoint no.). The length of a leg is too short, making it impossible for the ship to accomplish a turn. Lengthen the offending leg to accomplish the turn.
 - "Bad Turn at WPT XX" (XX=waypoint no.). The calculated ROT exceeds the maximum ROT, making it impossible for the ship to accomplish a turn. Increase the radius of the turn or lower the planned speed.
 - "Unchecked / Check condition differs". The route has not been checked. Check the route, on the [Alert Parameters] page.
 - "Monitored in the NAVI mode". The route is currently being monitored.
 - "More than one WPT needed". The route has only one waypoint. Add more waypoints to the route.
 - "Route monitoring cannot be started. Please check ship's position and conditions." Click the [OK] button to close the message. Check ship's position and conditions of the route.
- If you have small-scale chart(s) on display that have the whole eastern/western (0-180°E/0-180°W) hemisphere and a part of the other hemisphere on display, there is a limitation to display a route. To avoid this, set chart center so that the whole eastern/western hemisphere is not on the screen.
- The route check which occurs after selecting a route can take longer with C-MAP charts. Wait until the completion of the check.
- If, in the radar mode, route monitoring is stopped, the Alert 691 (ALF format: 10800,1) "RM Stop - Exceed Max XTE", 692 (ALF format: 10800,2) "RM Stop - Disconnect Sensors", or 693 (ALF format: 10800,3) "RM Stop - Other Causes" appears. If this occurs, switch to the Chart for Radar mode. The "Monitoring Failed" pop-up window appears. Click the OK button. Find the reason why route monitoring was stopped and then restart route monitoring.
- Route monitoring is temporarily stopped (route is grayed out) and an alert appears when the signal for position, speed or heading is lost. To restore route monitoring, change the sensor system from System to Local (from the Sensor Information box), manually enter the lost data, check [Set Drift], then switch to the DR mode.
- Route data is sent to the radar at the start of route monitoring or when the ship transits a waypoint. If a route is not displayed on the radar, stop then restart monitoring at the radar chart. A route is erased from the radar when route monitoring is stopped or the radar chart is restarted. To redisplay the route, stop then restart monitoring at the radar chart.
- When chart alerts are unchecked while planning a route (see section 11.1.2) and route monitoring is activated, a message appears in the permanent warning box.
 - [Safety Contour] unchecked: "Indication of crossing safety contour if Off. (in monitoring)"
 - [Areas to be Avoided] unchecked: "Indication of navigational hazards is Off. (in monitoring)"
 - Other alerts unchecked: "Indication of some prohibited areas or areas with special conditions is Off. (in monitoring)"
- If this radar is connected in the network to an FMD-3200/3300 ECDIS that is interfaced with an IEC 62065 Ed.2 compliant TCS (YOKOGAWA PT-900, Tokyo Keiki PR-9000, EMRI FAP-3000, Raytheon Anschutz NP-5400), the alert 174 (WPT Approach) is generated at each waypoint if the TCS is not connected to the ECDIS in route monitoring. Note that TCS is only available on FMD-3200/3300.

14.2 How to Stop Route Monitoring (Manual, Auto)

You can stop route monitoring in two ways:

- In the Voyage navigation mode, click the [Voyage] and [Stop Monitor] buttons. Route monitoring is also stopped automatically.
- In the Voyage navigation mode, click the [Voyage], [Route] and [Unselect] buttons.

When alert 691 (ALF format: 10800,1), 692 (ALF format: 10800,2) or 693 (ALF format: 10800,3) occurs, route monitoring is stopped automatically. See the Troubleshooting table in section 25.5 for details.

14.3 How to Select What Parts of a Route to Display

You can specify what parts of the monitored route to display. Click the [DISP], [SET] and [Symbol DISP] buttons on the InstantAccess bar™. Click the [Route] tab.

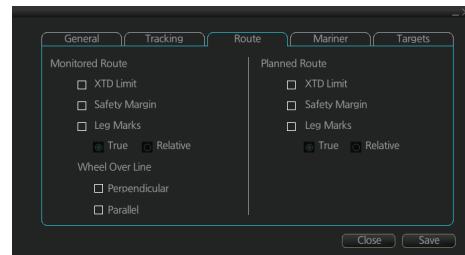

14.4 How to View Waypoint Information

Click the [Voyage] and [Monitor INFO] buttons on the InstantAccess bar™ to show the [Monitor Information] dialog box. Click the [Waypoints] tab to show waypoint information.

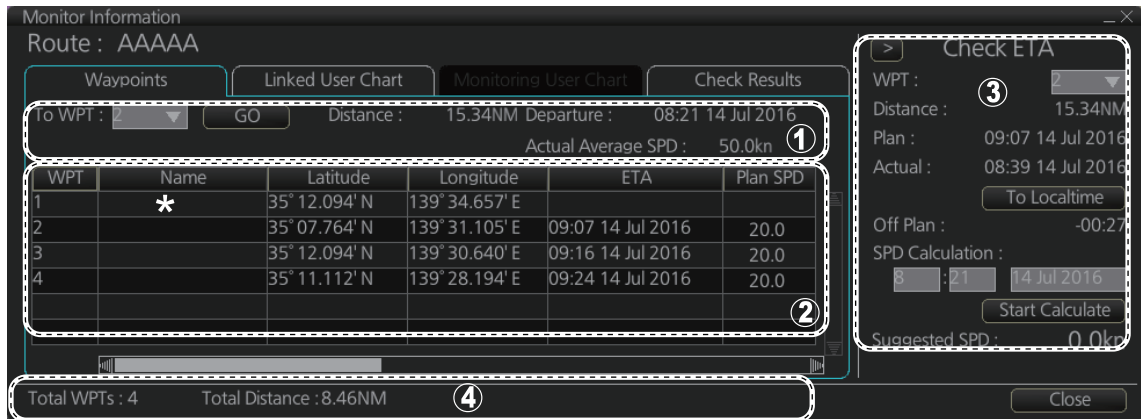

* Scroll list horizontally to view items shown in the right figure.

Leg/°	Leg/NM	STR mode	RAD/NM	XTD Limit/m	SPD MAX	Margin/m	Local Time
214.0	2.95	Rhumbline	0.80	185	22.1	40	+00:00
355.0	2.89	Rhumbline	0.80	185	22.1	40	+00:00
243.9	2.62	Rhumbline	0.80	185	22.1	40	+00:00

No.	Item	Description
1	[To WPT], [GO] button	The system selects a next waypoint automatically. Check that the To waypoint is the desired one. The system will automatically advance to a next waypoint when you pass the To waypoint. The default [To WPT] is WPT2. If you desire a different one, select it here and the click the [GO] button.
	[Distance]	Distance from current position to selected waypoint.
	[Departure]	The time the route was selected for monitoring.
	[Actual Average SPD]	The average speed over the ground, measured every 30 seconds.
2	Waypoint list	The waypoint list provides for each waypoint WPT no., name, latitude and longitude position, ETA, plan speed, bearing and distance to leg*, steering mode ([Rhumbline] or [Greatcircle]), radius, XTD limit, speed max, margin and local time. *: The bearing to a leg and the display method for leg distance can be changed. For details, see subsection 12.4.1. Can be changed. See "Leg/NM" on page 12-6.
3	[Check ETA] window	Parameters for checking ETA. The arrow to the left of [Check ETA] collapse or display the [Waypoints], [Linked User Chart] and [Check Results] tabs.
	[WPT], [Distance]	Select a WPT to find the distance to that waypoint from current position.
	[Plan]	The planned ETA to the selected waypoint.
	[Actual]	The actual ETA to the selected waypoint, if current speed is maintained.
	[To Localtime]	Switch between UTC and local time for ETA. For local time, the settings used in the creation of the route are used for the ETA calculation. See section 12.4.1.
	[Off Plan]	The time difference between planned ETA and calculated ETA to final WPT, when different. The indication is prefixed with "-" if earlier than planned; "+" if later than planned.
	[SPD Calculation]	Enter speed and ETA (time and date) to find the speed to use to arrive by the ETA.

3	[Start Calculate] button	Click to start calculation. The button label changes to [Stop Calculate].
	[Suggested SPD]	The system calculates suggested speed so that ETA to the WPT selected would be same as planned ETA if type of optimization was "Time table".
4	[Total WPTs]	The total number of waypoints in the route.
	[Total Distance]	The total distance of the route.

14.5 How to View User Chart Information Linked Monitoring Route

1. In monitoring route mode, click the [Voyage] and [Monitor INFO] buttons on the InstantAccess bar™ to show the [Monitor Information] dialog box.
2. Click the [Linked User Chart] tab.

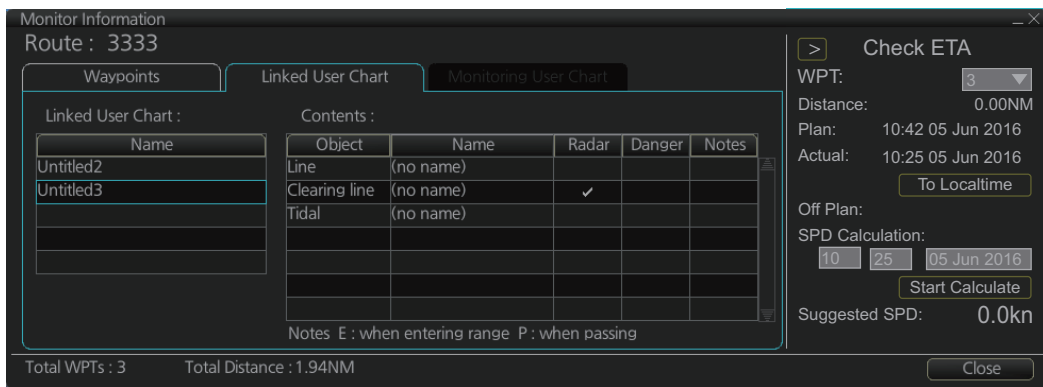

The [Linked User Chart] list shows all the user charts linked with the monitored route and their contents. Click a user chart name to show the contents of the chart in the [Contents] window. For the [Check ETA] window, see the preceding page.

14.6 How to View User Chart Object Information in Route Monitoring

In route monitoring, you can cursor pick user chart objects to show their information. Put the cursor on the user chart symbol to show the pop-up menu. Select [User Chart INFO] from the pop-up menu. Below are some examples of user chart info.

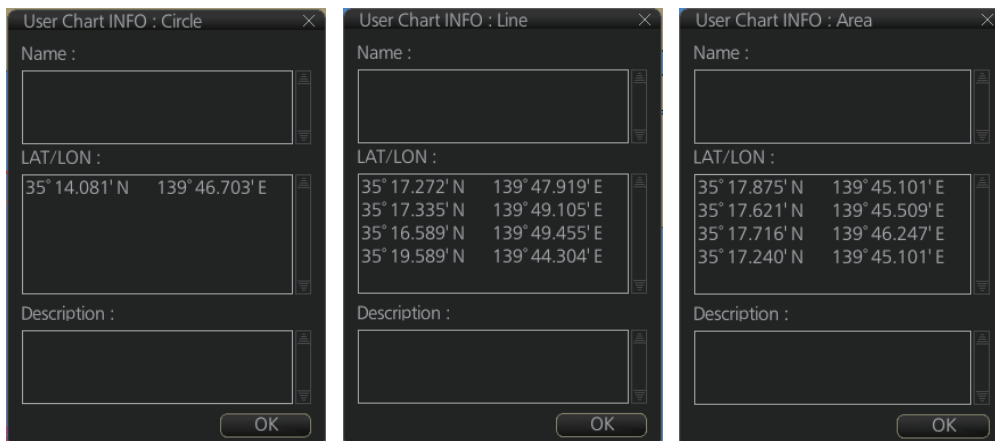

User chart INFO: Circle

User chart INFO: Line

User chart INFO: Area

14.7 How to Change Monitored Route to Planned Route

The monitored route can be transferred to the Voyage planning mode. This is useful when you don't need the route for monitoring but want to edit it. To transfer the monitored route, click the [Voyage], [Route] and [Move to Plan] buttons on the InstantAccess bar™.

Up to five planned routes can be shown on the display. If you try to display another route, the route list appears. Deselect a route in order to transfer the monitored route to the Voyage planning mode.

Note: When the monitored route is changed to a planned route, using the [Move to Plan] function, the operating mode changes from the Navigation voyage mode to the Voyage planning mode.

14.8 How to Use Instant Track to Return to or Deviate from Monitored Route

The instant track feature provides a temporary track, consisting of four waypoints, to return to or deviate from the monitored route. Correct data from navigation sensors is essential to this function.

There are two instant track modes: [Safe Off Track] and [Back to Track].

[Safe Off Track]: This mode provides a track from the monitored route to a safe location to avoid collision or the like.

[Back to Track]: This mode creates a track to follow to return to the monitored route when the vessel goes outside the channel limits.

The mode is automatically selected according to whether a monitored route is active or not and the amount of off course. Further, if a monitored route is active while following the instant track route, the instant track mode can be changed manually.

Condition	Mode	Manual mode switching
Neither monitored route nor instant track route active.*	[Safe Off Track]	No
<ul style="list-style-type: none"> • Both monitored route and instant track route are active.* • The absolute value of off track is within the channel limit setting. 	[Safe Off Track]	Yes
<ul style="list-style-type: none"> • Both monitored route and instant track route are active.* • The absolute value of off track is outside the channel limit setting. 	[Back to Track]	Yes

* An additional instant track route can continuously be created and monitored while monitoring the instant track route.

The parameters for the track (channel limit, turn radius, etc.) can be set on the [Instant Track] page. See section 21.4.

14.8.1 Safe off track mode

If it becomes necessary to deviate from the monitored route; for example, to avoid collision, use the [Safe Off Track] mode to create an instant track to a safe location. An instant track can be created without a monitored route.

1. When the monitored route is active, click the [Voyage] and [Instant Track] on the InstantAccess bar™ to show the [Instant Track] dialog box. The message "Please click a destination." appears on the [Planning] page.

Note 1: If a monitored route is active, the [Back to Track] mode can also be selected.

Note 2: If a monitored instant track route is already active, an instant track mode different from the currently active one can be selected.

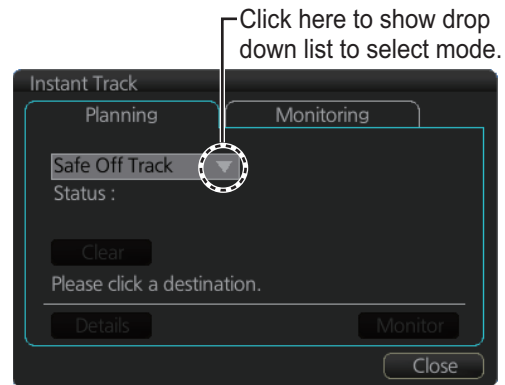

When monitored route is active

2. Click a destination. The location is marked with an orange circle and arrow. The message "Please click a point to decide an angle." appears in the [Instant Track] dialog box. The location must be within 50 NM of current position.
3. Roll the trackball to select the angle of approach to the destination then click.

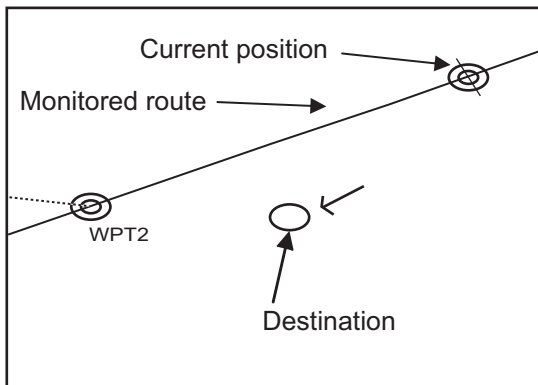

① Click destination point .
A circle and arrow appear.

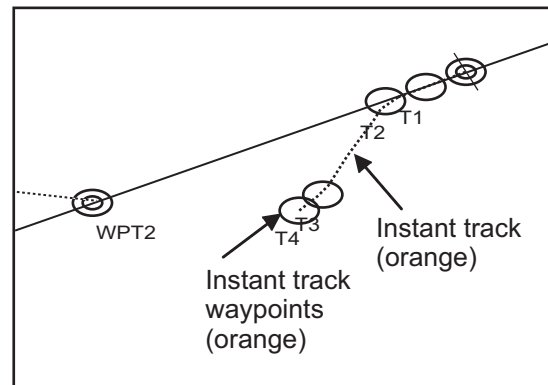

② Click a location to set desired angle of approach.
Instant track is drawn.

The system uses ship position, speed, angle of approach to create an instant track route. The track is also checked for hazardous objects and the like against the chart alerts.

During the calculation, the [Instant Track] dialog box shows "Checking" in the [Status] field. If, after completion of the calculation, the track is suitable, the message "OK" replaces "Checking". The track and its waypoints, labeled [T1] - [T4], are colored orange. The track is saved to the database as "InstantTrack_XXX" (XXX=001 - 400).

If clicking the [Clear] button while or after creating the track, the track is erased from the screen.

If there is a problem with the track, an error message appears and the track is erased from the screen. See section 14.8.3 for all the instant track messages and their meanings.

To return to the monitored route, click a waypoint on a leg of the route to create an instant track route to use to return to the monitored route.

14.8.2 Back to track mode

When the vessel goes off track, the Alert 172 (ALF format: 172) "Off Track Alarm" appears in the [Alert] box. To create an instant track to return to the monitored route, use the [Back to Track] mode as follows:

1. When the monitored route is active, click [Voyage] and [Instant Track] on the InstantAccess bar™ to show the [Instant Track] dialog box. The message "Please click a WPT on Leg." appears on the [Planning] page.

Note 1: If a monitored route is active, the [Safe Off Track] mode can also be selected.

Note 2: If a monitored instant track route is already active, an instant track mode different from the currently active one can be selected. Further, a completely new instant track route to the original monitored route can be created.

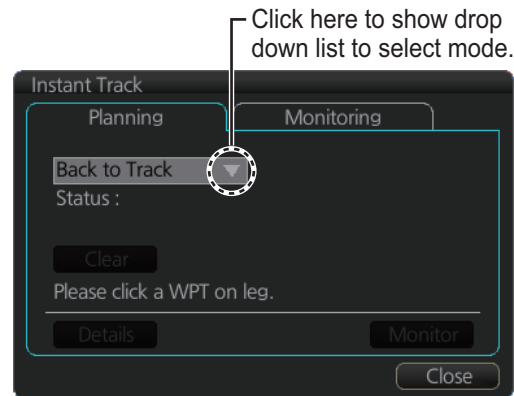

When monitored route is active

2. Click a leg or a waypoint on the monitored route. The location must be within 50 NM of current position.

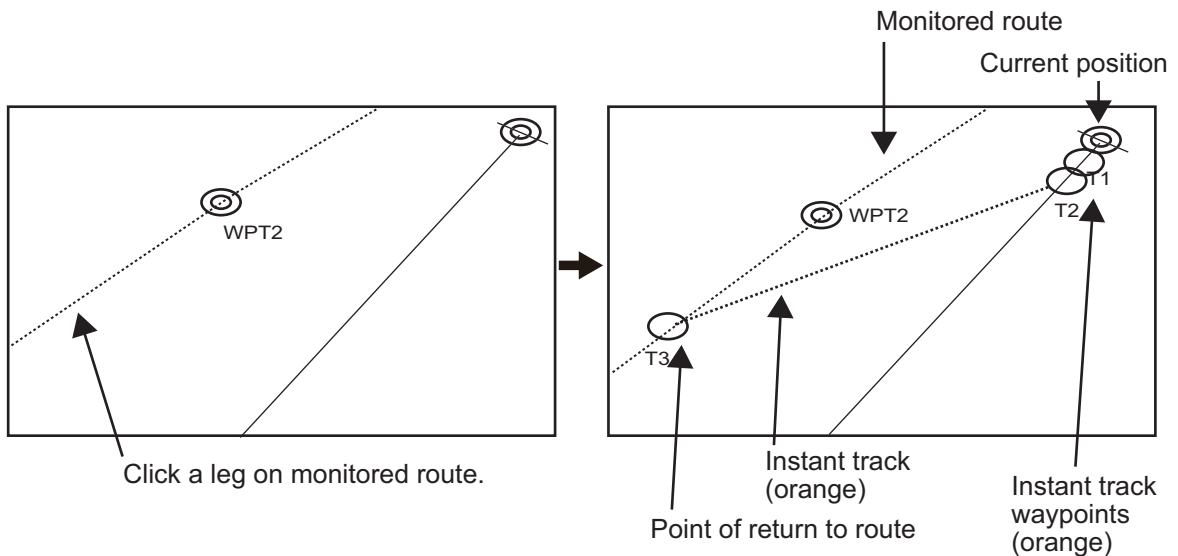

The system uses ship position, speed and final waypoint to create a track. The track is also checked for hazardous objects and the like against the chart alerts.

During the calculation, the [Instant Track] dialog box shows "Checking" in the [Status] field. If, after completion of the calculation, the track is suitable, the message "OK" replaces "Checking". The track and its waypoints, labeled [T1] - [T3], are colored orange. The track is saved to the database as "InstantTrack_XXX" (XXX=001 - 400).

If clicking the [Clear] button while or after creating the track, the track is erased from the screen.

If there is a problem with the track, an error message appears and the track is erased from the screen. See section 14.8.3 for all the instant track messages and their meanings.

14.8.3 Instant track messages

The table below shows all the instant track messages and their meanings.

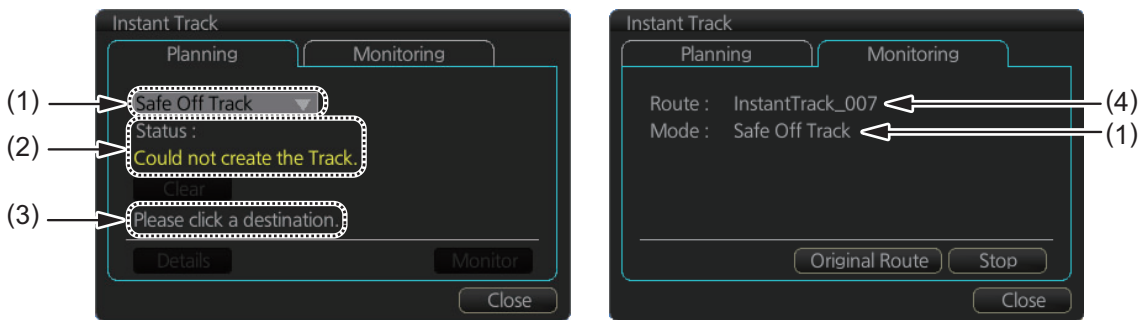

Message	Meaning	Color
(1) Instant Track mode		
"Back to Track"	Back to track mode	White
"Safe Off Track"	Safe off track mode	White
(2) Check result, error message		
"Could not create the Track."	The track could not be created.	Yellow
"Too far destination from own ship."	Selected destination is 50 NM or more from current position.	Yellow
"ROT data is not inputted correctly"	No ROT data input, or data is incorrect. Cannot create instant track.	Yellow
"Checking..."	Checking route.	Red
"OK"	Instant track checked and is suitable to follow.	Green
"NG"	Instant track check failed.	Red
"Check error."	Route check error.	Red
"Instant Track is expired."	Route monitor timeout.	Red
"Too many WPTs in monitoring route."	More than 190 waypoints are in the monitored route. (Instant track cannot be created.)	Red
(3) User operation message		
"Please click a destination."	Select a destination in the [Safe Off Track] mode.	White
"Please click a point to decide an angle."	Set the angle of approach in the [Safe Off Track] mode.	White
"Please click a WPT on leg."	Click a waypoint on a leg in the [Back to Track] mode	White
(4) Name of instant track route		
InstantTrack_XXX (XXX: 001 - 400)	Name of monitored instant track route	White

14.8.4 Instant track details

You can see the location and alert type found in an instant track by clicking the [Details] button on the [Planning] page in the [Instant Track] dialog box.

Note: If the Status is not [OK], an alert (alarm or warning priority, depending on set-ting) appears in the Alert box.

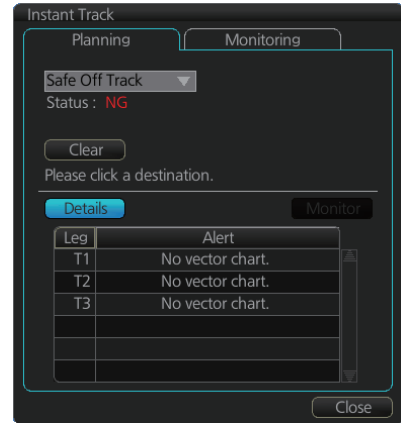

14.8.5 How to monitor, stop monitoring an instant track route

How to monitor an instant track route

If the route check results is "OK", click the [Monitor] button on the [Planning] page in the [Instant Track] dialog box to start monitoring the instant track route. Click the button before the time remaining counts to zero, otherwise the instant track will be canceled, followed by the message "Instant Track is expired." After the [Monitor] button is clicked the [Monitoring] page is opened. The [Monitoring] page shows the name of the instant track and the instant track mode.

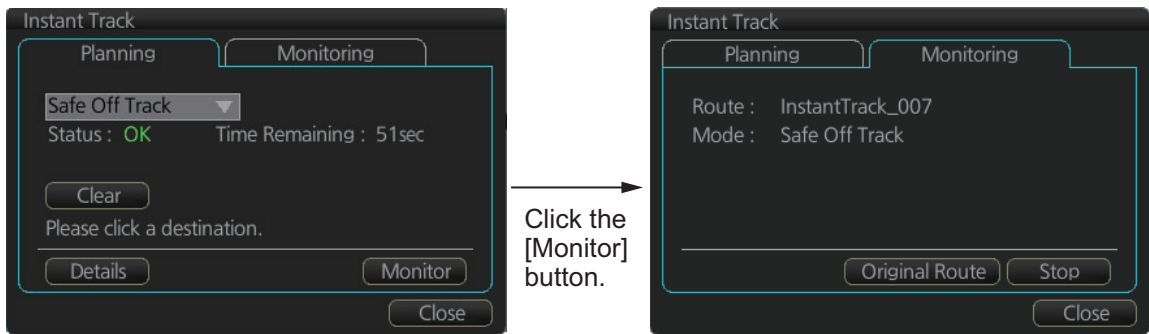

The vessel follows the instant track route in the same method as a monitored route, which is grayed out to indicate it is inactive. For the instant track route connected to a monitored route, the previous instant track route is also grayed out to show it is inactive. Any additional instant track routes are erased.

To close the [Instant Track] dialog box, click the [Close] button. (The system continues monitoring the instant track route.)

The following occurs when sensor data is lost while using the instant track function.

Monitoring condition	Result
Instant track route monitoring.	<ul style="list-style-type: none"> An instant track route under creation is deleted. No route can be created. The [Stop] button is pushed or the instant track route is followed until its completion. After the instant track route is completed, an error message appears and the [Instant Track] dialog box closes.
No monitored route	An instant track route under creation is deleted.
Monitored route active	After the route is completed, an error message appears and the [Instant Track] dialog box closes.

Note: If there is no original route (safe off-track mode only) or the original route is not checked, the message "Not checked against ENC chart" appears in the permanent warning box.

How to stop monitoring an instant track route

Click the [Stop] button on the [Monitoring] page in the [Instant Track] dialog box to stop monitoring the instant track route. The system returns to monitoring the monitored route and the [Planning] page of the [Instant Track] dialog box opens.

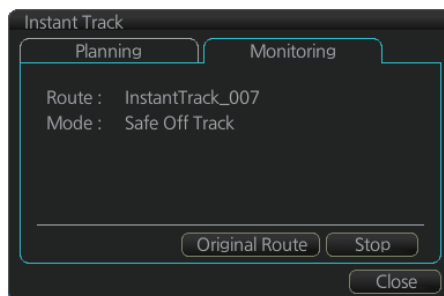

For the [Back to Track] mode, the instant track mode is canceled when the vessel returns to the monitored route. The instant track is grayed out to show that is inactive.

14.8.6 How to change a monitored route when following an instant track route (safe off track mode only)

Do the following to change a monitored route while following an instant track route.

1. While monitoring an instant track route, click the [Original Route] button on the [Monitoring] page in the [Instant Track] dialog box to show the [Select Route] dialog box. Check [Planned Route] to show a list of planned routes, or check [Instant Track] to show a list of instant track routes.
2. Select the route to use. The original route or the instant track route currently in use cannot be selected.
3. Click the [Open] button to close the dialog box. The vessel starts following the newly selected route.

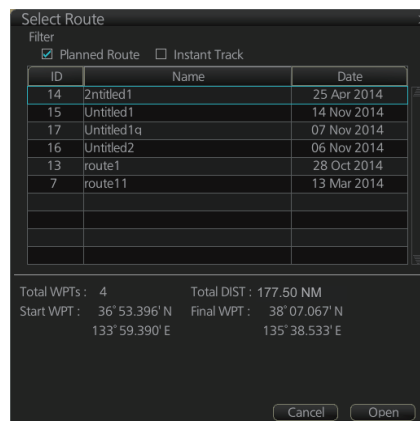

When an instant track route is completed, the vessel starts following the route selected at step 2.

14.8.7 Button label and unit state

The label on the button at the position circled in the figure below changes according to the state of the instant track.

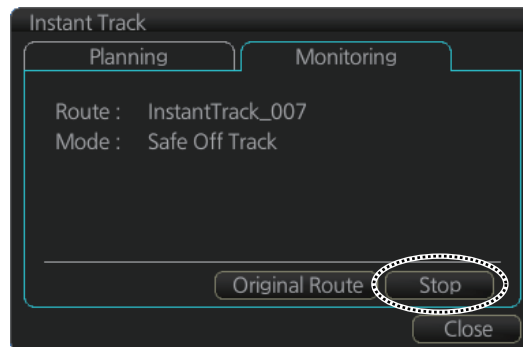

Instant track state	Button label
Creating	[Monitoring]
Monitoring	[Stop]
Return to original route after back to track mode	[Reset] (Instant track route is erased - another instant track route can be created.)

14.9 How to Share Route During Route Monitoring

With multiple EC-3000 units, you can share the route monitored on the master EC-3000 unit with other units (FMD-3x00, FCR-2xx9 or FAR-3xx0).

Follow the procedure below to enabling the route sharing feature.

1. Open the menu, select [Monitoring] from the [Shared] menu to show the [Setting] dialog box.

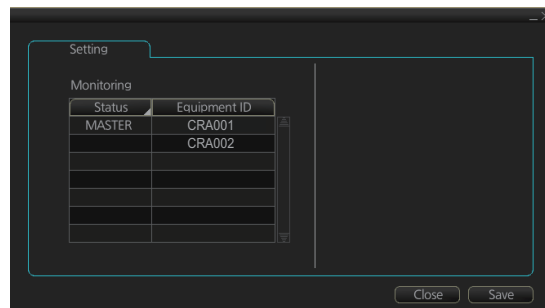

2. Right click the equipment ID of the unit to show the pop-up menu. Select [MASTER], [BACKUP], [SYNC] or [CLEAR] as appropriate.
 - [MASTER]: Assigns selected unit as the master unit. One unit must be assigned as the master unit.
 - [BACKUP]: Assigns the selected unit to share route monitoring. Only one unit can be assigned to share route monitoring. When route monitoring starts on the master, the route and its information are displayed on the backup. If the master stops during route monitoring, the backup will act as the master.
 - [SYNC]: Selected unit receives and displays the route data output from the master, and monitors the route displayed on the master.
 - [CLEAR]: Removes the selected unit from route monitoring sharing.

Note: To restore the original setting for units, click the [Status] column, then select [Reset].
3. Click the [Save] button to save settings, then click the [Close] button to finish.

14. HOW TO MONITOR ROUTES

This page is intentionally left blank.

15. NAVIGATION TOOLS

This chapter presents the various navigation tools available with the system. With the exception of the divider, the tools listed below are in the [Overlay/NAV Tools] box.

- TT/AIS (see chapters 3 and 4)
- Echo*¹
- Parallel index lines
- Look-ahead
- Range rings
- Predictor
- Anchor watch
- Under keel clearance
- Curved EBL*²
- Divider

*¹: Shown only when the [Echo] page is enabled at installation. Not available for B types.

*²: Shown only when a EC-3000 with TCS functionality (optional specification) is connected to the network.

15.1 How to Access the NAV Tools in the Overlay/NAV Tools Box

The [Overlay/NAV Tools] box is located at bottom-right position on the screen. There are two methods to access the NAV Tools.

- Click the page selection buttons to show the desired page.
- Right-click the Overlay/NAV Tools box to show the context-sensitive menu, then click the desired page.

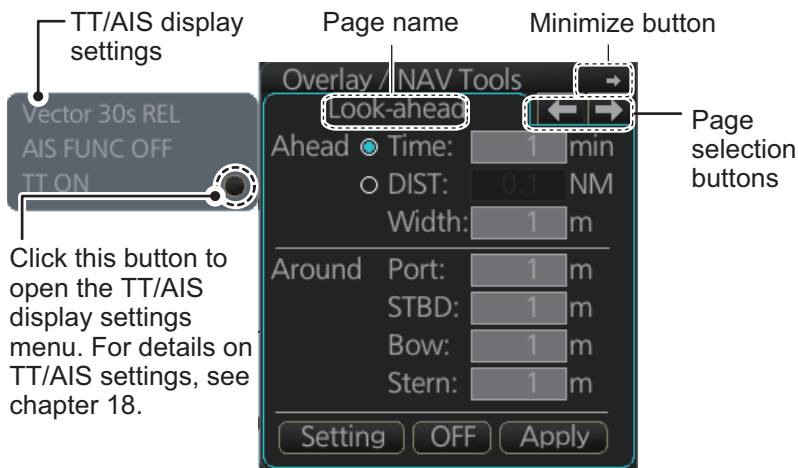

[Overlay/NAV Tools] box ([CheckArea] page)

15.2 Radar Overlay

If the Echo page is enabled at installation, you can show the radar echoes “overlaid” on the chart (Voyage navigation mode only).

Note: For B type radars, the [Echo] page is not available.



This ECDIS has many features to support exact match in scale and orientation of the chart and radar echo image. Exact match of the radar echo image and chart is an essential security feature. If the radar echo image and the chart display match, then the mariner can rely on what he sees and the mariner also gets a very good confirmation that his navigation sensors (such as gyro and position receivers) operate properly and accurately. However, if the mariner is unable to achieve exact match, it is a very strong indication that something is wrong and he should not rely on what he sees.

Selected scale of displayed chart also defines scale of radar overlay. When you change the chart scale, the scale of the radar overlay is automatically changed. The table below shows the standard scale and equivalent radar range.

Radar range (nm)	Standard scale	Radar range (nm)	Standard scale
0.25	1:4,000	6	1:90,000
0.5	1:8,000	12	1:180,000
0.75	1:12,000	24	1:350,000
1.5	1:22,000	48	1:700,000
3	1:45,000	96	1:1,500,000

15.2.1 How to show the radar overlay

Radar echoes can be output to the ECDIS and shown on its display. Like details on S57 charts, the radar overlay can be displayed or removed from the chart display. The transparency of the echo display can be set from the [Echo] page in the [Overlay/NAV Tools] box. To activate and setup the radar overlay, do the following:

1. With the system in [RADAR] mode, begin radar transmission.
Note: While the system is preparing for radar transmission, the radar overlay is not shown on the chart display.

2. Switch the system to [CHART for RADAR] mode, then select the [Echo] page from the [Overlay/NAV Tools] box.

3. Click the [ON/OFF] button at [Display] to show [ON] (radar overlay ON) to activate the overlay. "Status: OK" appears under [Antenna] if the radar signal is being received. "Status: No Data" is displayed if there is no radar signal.

Note: The radar display, TT symbols and AIS symbols can also be hidden by clicking [CLEAR RADAR] on the Status bar.

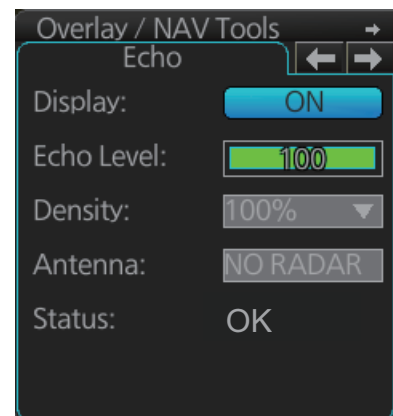

4. [Echo Level] adjusts the sensitivity of the radar picture. To adjust, put the cursor on the slider bar and roll the scrollwheel.
5. [Density] controls the "see through" behavior of the radar overlay. [100%] overlays the radar echo on the chart without modification. "75%" displays radar echoes faintly, and "25%" displays radar echoes somewhat faintly. It is recommended to use 25% or 50% when navigating narrow channels, so as not to conceal land-masses.
6. Click the [Antenna] drop-down list to select the radar that is to feed radar echoes.

15.2.2 Error Between Radar Echo Image and Chart

There are several reasons why the radar echo image and chart display do not match exactly. The mismatch is a combination of several reasons and removing one reason doesn't solve the mismatch perfectly. There is a fundamental difference between the radar echo image and corresponding chart feature. The radar echo is a reflection from the real life target and the actual position of the real life target is the front edge of the radar echo. Therefore, the radar echo should start from the chart feature and exist as far as the radar pulse length goes.

How to compensate for bearing error

Bearing error occurs in the following instances:

- Gyro error
- Inaccurate chart
- Improper installation parameters (radar overlay bearing offset)

How to compensate for position error

Position is caused by the following:

- Inaccurate position
- Position offset
- Inaccurate chart
- Improper installation parameters (conning position offset, position receiver antenna offset, radar overlay range offset)

15.2.3 Error Sources for Radar Echo Image and TT Mismatch

There are several reasons why the radar echo image and tracked target symbols do not match exactly.

1. Different gyro value at radar overlay and at ECDIS.
2. Improper installation parameters (radar overlay bearing offset, radar overlay range offset, conning position offset).

The example below shows how different gyro value set at radar overlay and at ECDIS affect the display of the ECDIS.

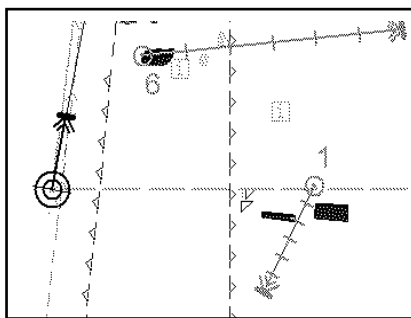

Different gyro value at radar and ECDIS

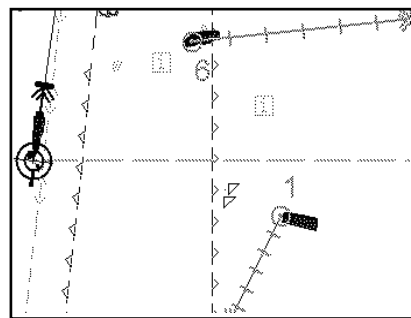

Equal gyro value at radar and ECDIS

15.3 Parallel Index (PI) Lines

The parallel index lines are useful for keeping a constant distance between own ship and a coastline or a partner ship when navigating. There are six sets of PI lines (PI-P6) and you can turn them on or off individually. Select the PI line to process with the [Display] pull-down list then click the [ON] or [OFF] button as appropriate. One, two, three or six lines can be shown - the actual number of lines shown depends on the line interval.

Only one set can be shown.

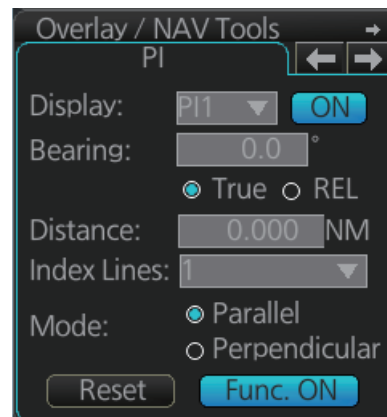

15.3.1 How to activate, deactivate PI lines

Select the PI line(s) set to activate or deactivate with the [Display] drop-down list. Activate or deactivate the set selected with the [ON], [OFF] button.

The [Func. ON], [Func. OFF] button globally activates, deactivates all PI lines selected to [ON].

15.3.2 PI line bearing reference

PI line bearing reference may be relative to own ship's heading (Relative) or referenced to North (True). Select [True] or [REL].

15.3.3 Number of PI lines to display

The maximum number of PI lines to display may be selected from 1, 2, 3 or 6 lines as below. The actual number of lines visible may be less depending on line interval. Select the number of lines to display at [Index Lines].

15.3.4 PI line mode

The PI line mode can be set for parallel (0-degrees) or perpendicular (90-degrees). Select [Parallel] or [Perpendicular] at [Mode].

15.3.5 How to adjust PI line orientation, PI line interval

There are two ways to adjust PI line orientation and PI line interval: through the menu and on the screen.

How to adjust PI line orientation, PI line interval from the menu

1. Set the orientation with [Bearing].
2. Set the line interval with [Distance].

How to adjust PI line orientation, PI line interval on the screen

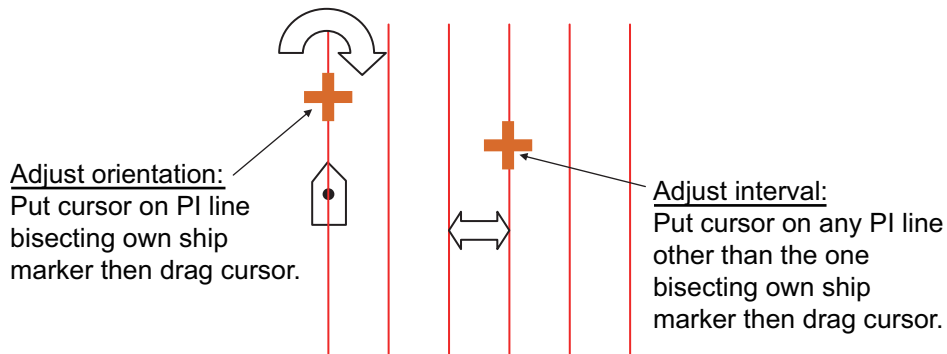

How to adjust orientation and interval, multiple PI lines

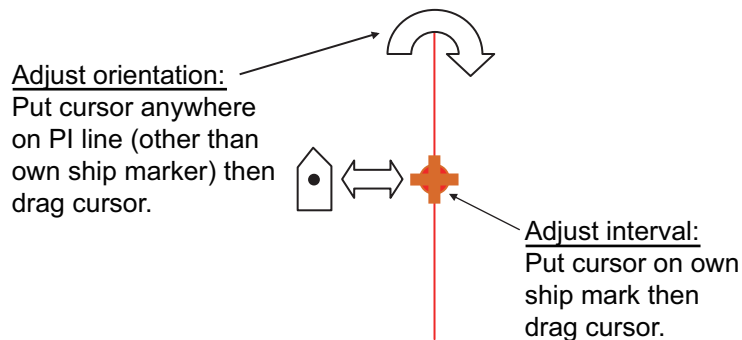

How to adjust orientation and interval, single PI line

15.3.6 How to reset the PI lines

You can automatically return PI lines to default orientation, 0-degrees for parallel orientation, 90-degrees for perpendicular orientation. This is faster than doing it manually. Click the [Reset] button to reset the parallel lines.

15.3.7 How to adjust PI line length

You can adjust the forward and backward lengths of a PI line when [Index Lines] is set to 1.

1. Open the MENU and select [NAV Tools] and [PI Lines].



2. If not already displayed, click the [ON/OFF] button to display the PI line whose length you want to adjust.
3. Click the value in [Forward] and [Backward] columns to adjust their lengths, referring to the illustration below.

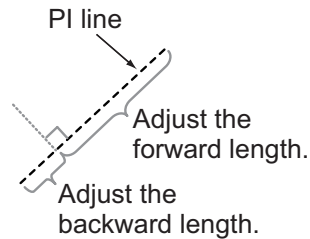

4. Click the [Save] button to finish.

15.4 Look-ahead

Look-ahead sets the area ahead and around own ship for which to check for safe navigation. See section 11.2 for how to activate own ship check.

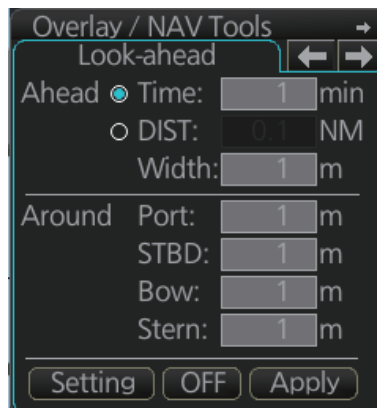

15.5 Ring

The range rings are the concentric set of rings on the chart display. They provide an estimation of the range to an object. You can turn them on or off from the [Ring] page.

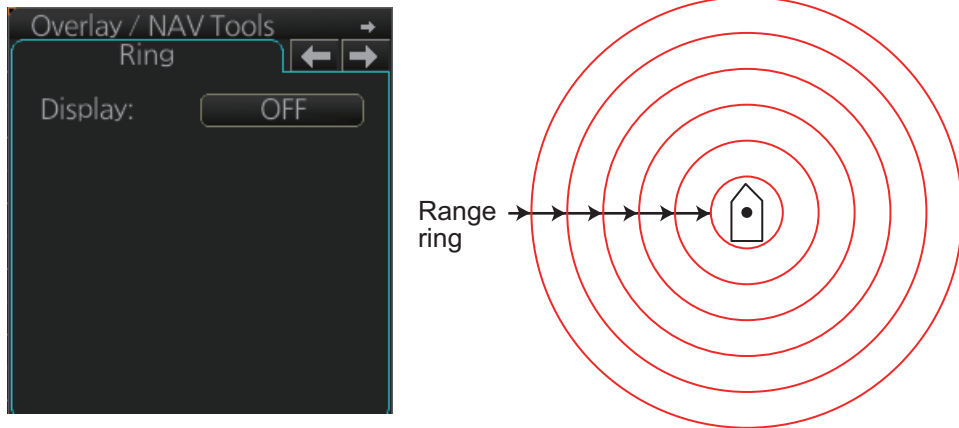

The interval between rings changes with the chart scale as shown in the table below.

Chart scale	Ring interval (nm)	Chart scale	Ring interval (nm)
1:1,000	0.025	1:100,000	2.0
1:2,000	0.05	1:200,000	4.0
1:5,000	0.10	1:500,000	8.0
1:10,000	0.25	1:1,000,000	16.0
1:20,000	0.5	1:2,000,000	20.0
1:50,000	1.0		

How to select the range calculation method

The range calculation method for the EBL and VRM can be selected to Rhumbline or Great Circle. Do as follows to select a calculation method.

1. Open the menu, then select [NAV Tools] and [Geometry] to show the [Geometry] page.

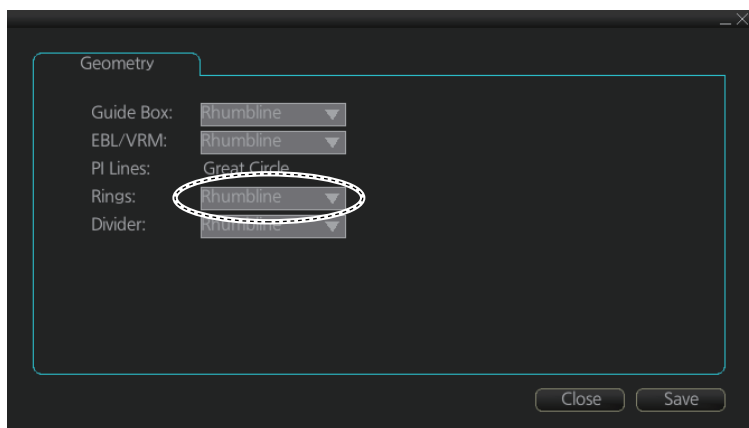

2. Select [Rhumbline] or [Great Circle] with the drop down list box for [Rings].
3. Click the [Save] button to save the setting, then click the close button to finish.

15.6 Predictor

The predictor is a tool for estimating your ship's future positions and behavior. The on-screen predictor graphic consists of three pieces of your ship, drawn in true scale to successive future positions. The position of the third symbol will be your approximate position at the end of the time interval selected. The predictor is calculated using current speed and rate of turn. Docking speed components (transversal bow speed, transversal stern speed, transversal center speed and rate of turn) are assumed to be stable during the prediction period. The predictor can be used in every steering-state, including manual steering.

To activate and set the Predictor, show the [Predictor] page. Turn the display on or off with [Display]. Set the time (30, 60, 90, 120, 150, 180 seconds), with [Time].

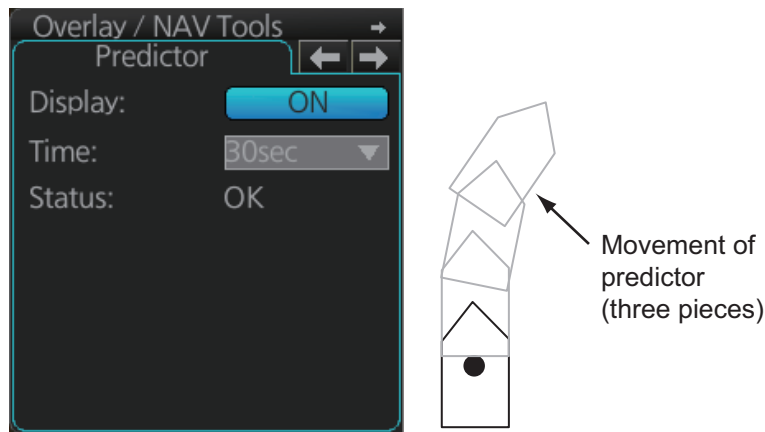

The Predictor is updated every three seconds internally and the status of the predictor is shown with [Status] as shown in the table below.

Indication	Status
OK	Speed is suitable, in accordance with estimation of ship's dynamics.
Not Enough Speed	Speed is too low, in accordance with estimation of ship's dynamics.
Not Available. Reset Filter May Restore.	Calculation not possible, in accordance with estimation of ship's dynamics.

Note: The ship speed must be 0.5 kn or higher. The predictor may not be displayed or may not work properly if the speed is lower than that value.

15.7 Anchor Watch

The anchor watch feature checks to see if your ship is drifting when it should be at rest. The anchor mark appears at the location of your ship's anchor. You can adjust the location for the anchor (see section 22.12).

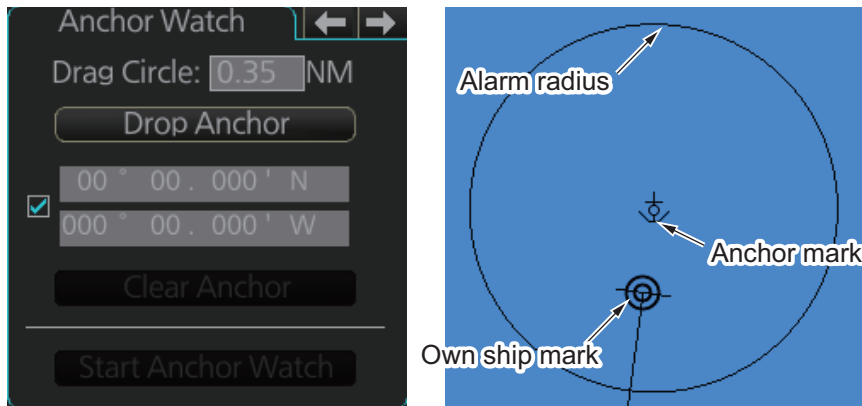

To set the anchor watch:

1. Select the [Anchor Watch] page.
2. Set the alarm radius (in nautical miles) with [Drag Circle].
3. Drop the anchor then click the [Drop Anchor] button.
The anchor mark and alarm radius circle appear. You can adjust the location of the anchor mark and the alarm radius by drag and dropping them.
Note: A latitude and longitude position can be set as the anchor watch position. Put a checkmark in the box below the [Drop Anchor] button to show the latitude and longitude input boxes. Enter latitude and longitude then click the [Drop Anchor] button.
4. Click the [Start Anchor Watch] button to start the anchor watch.

If your vessel travels more than the distance set here, the corresponding caution is generated.

If your ship drifts more than the anchor watch setting, the Alert 495 (ALF format: 10802) "Anchor Watch Setting" appears. The alert is escalated from warning level to alarm level if the alert is not acknowledged within two minutes. Also, if your vessel returns to within the tolerable radius, the alert is status is automatically changed to rectified.

To continue to use the anchor watch, click the [Clear Anchor] button to set the alarm about your current position. To stop the anchor watch, click the [Stop Anchor Watch] button. The caution is not generated even if your ship drifts more than the distance set with [Drag Circle]. Also, if the anchor watch alert is active and the [Stop Anchor Watch] button is clicked, the alert is also acknowledged and rectified.

15.8 UKC (Under Keel Clearance)

15.8.1 UKC overview

UKC is the distance between the deepest point of the vessel's hull and the seabed. The UKC feature continuously checks the ship's draught setting and actual speed.

When a look-ahead area is set and the depth within the set area gets shallower than the UKC, the Alert 634 (ALF format: 10173,1) "UKC Limit" is generated.

UKC takes into account the amount of hull subsidence (Squat Effect). The evaluation criteria for Alert 634 (ALF format: 10173,1) is not based solely on the distance from the keel to the seabed, UKC or draught.

Note: When conducting a route check, UKC is calculated based on the planned speed for each leg.

The Echo Alarm Limit is compared with the depth (raw data) from the sensor. If the depth is smaller than the echo alarm limit, the Alert 485 (ALF format: 10801) "Depth Limit" and Alert 644 (ALF format: 10644) "Actual UKC Limit" are generated.

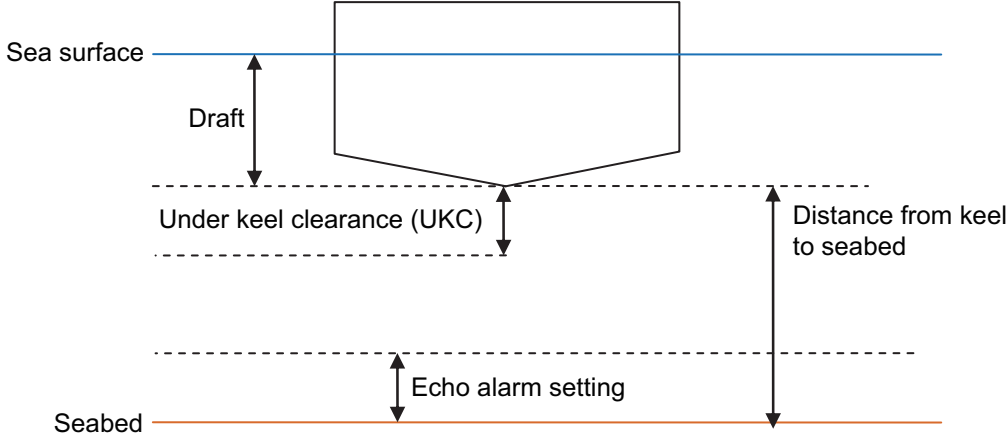

15.8.2 How to set UKC

1. Select the [UKC] page from the [Overlay/NAV Tools] box.
2. Use [Echo Alarm Limit] to set the distance for the echo alarm. To activate the alarm, click the [ON/OFF] button to show [ON].
3. At [UKC Limit], set ship's UKC limit. To activate the UKC feature, click the [ON/OFF] button to show [ON].
4. Use [Current Draught] to set your ship's draft. Be sure to change the setting whenever the draft changes.
5. Use [Type] to set the shape of your ship's hull to show on the [UKC] window, [V-shape] or [Concave]. See the figure in section 15.8.2.
6. Click the [Apply] button.

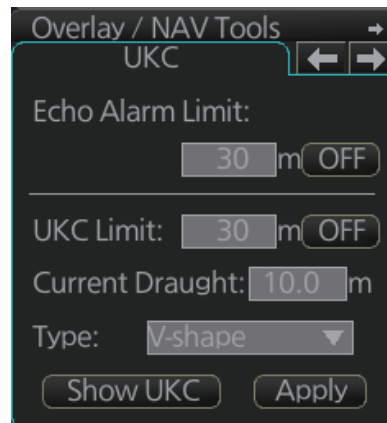

15.8.3 UKC window

The UKC window provides a visual graphic of the relationship between UKC, draft and current depth. The window can be shown or hidden as desired and located anywhere within the electronic chart area. To show the window, click [Show UKC Window] on the [UKC] page. To move the window, drag and drop.

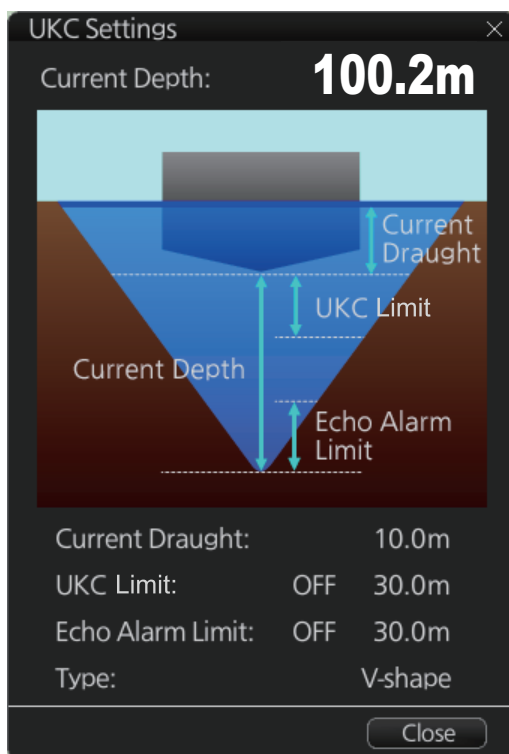

V-shape hull presentation

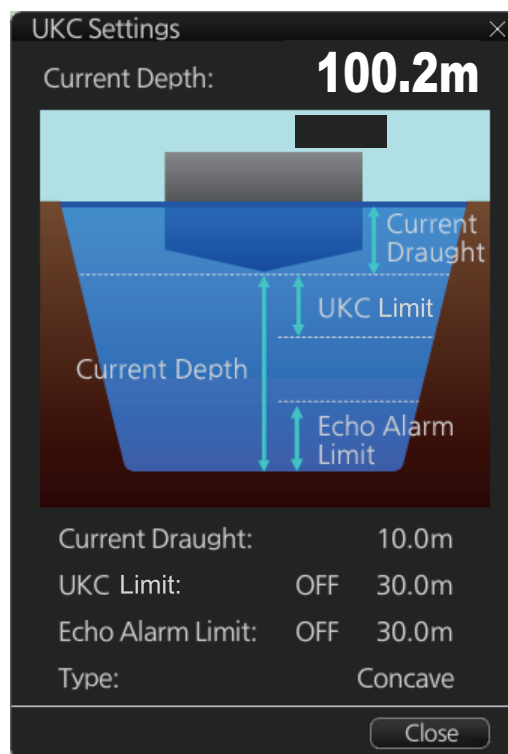

Concave hull presentation

15.9 Curved EBL

The [Curved EBL] function shows the planned steering radius. You can use this function to determine the best location to begin a turn. You can also use the [Curved EBL] function to determine whether a turn is conducted as planned.

To show/hide the [Curved EBL], click the [ON]/[OFF] button on the [Curved EBL] page of the [Overlay/NAV Tools] box.

Note: This function is only available when a EC-3000 with TCS functionality (optional specification) is connected to the network.

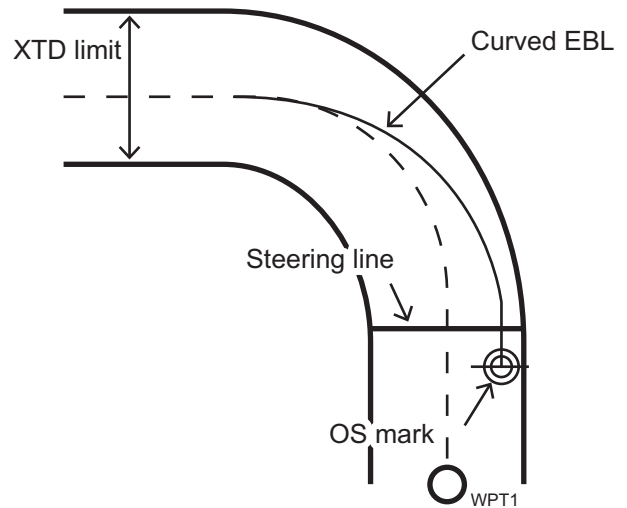
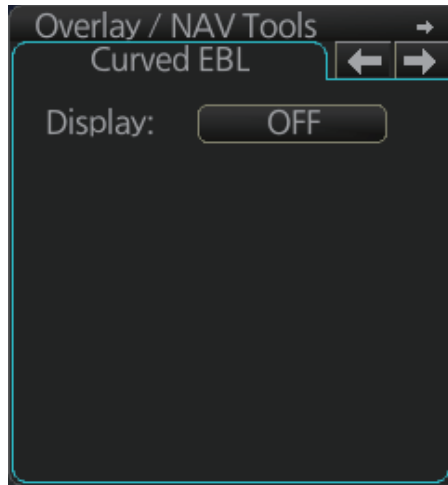

15.10 Divider

The divider performs the following calculations:

- Range and bearing between two points
- TTG between two points
- Total TTG from start to end
- Total distance from start to end

The divider is available in the Voyage navigation and Voyage planning modes. Only one divider can be displayed. The divider is neither saved nor shared among other units (FMD-3x00, FCR-2xx9 or FAR-3xx0).

15.10.1 How to use the divider

Do as shown below to use the divider.

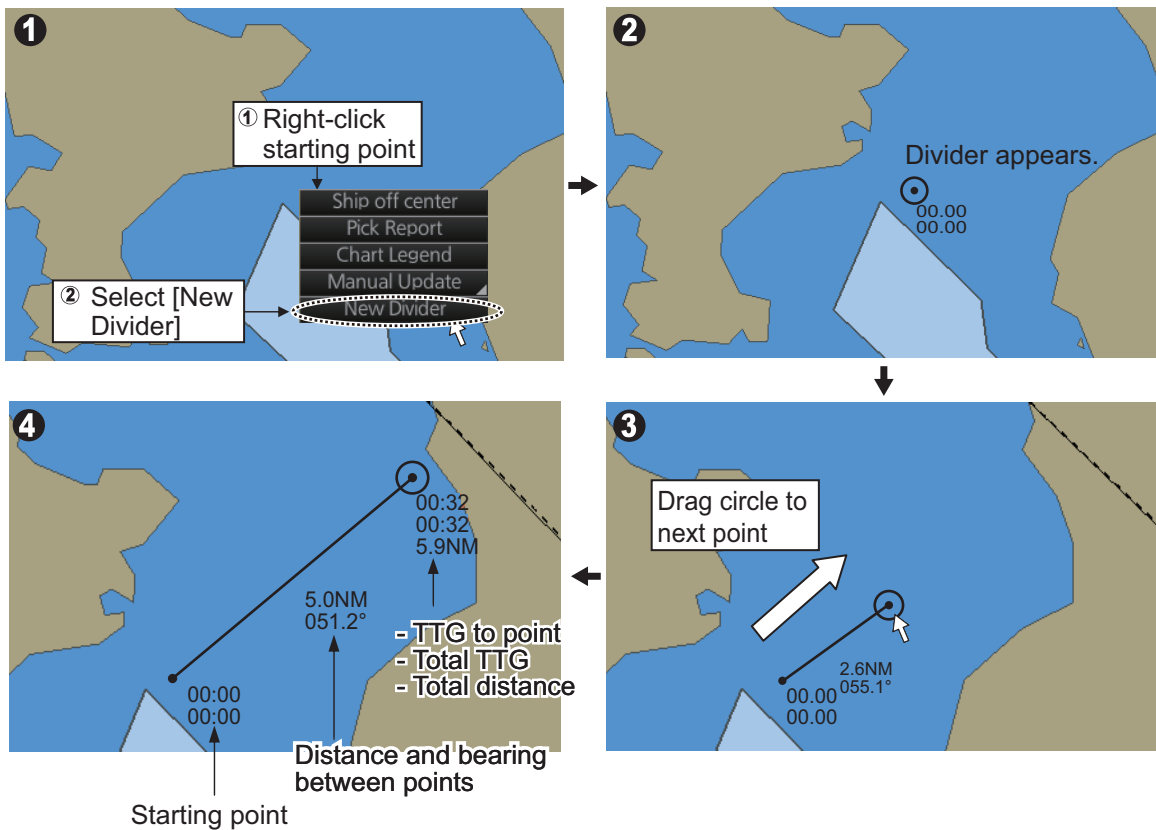

How to delete points

Point(s) can be deleted. Put the cursor on a point, right click, then select [Delete Points] from the pop-up menu. The point(s) deleted depends on the point selected.

End point

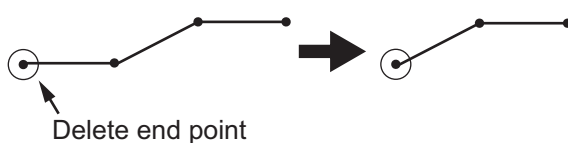

Intermediate point

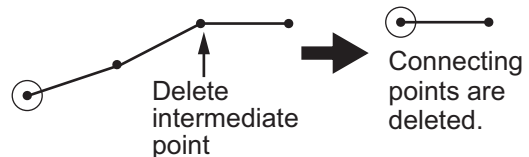

You can also drag from an intermediate point to make another point.

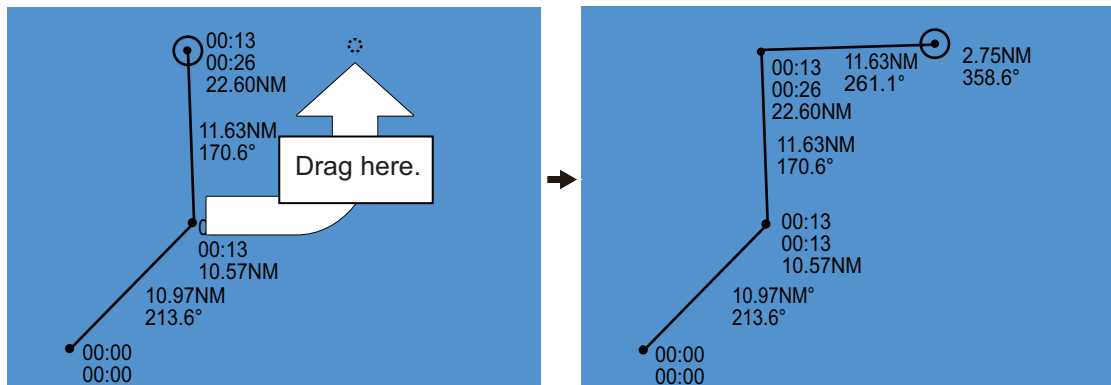

Note: If you drag a point to the edge of the displayed area, the chart scrolls in that direction.

15.10.2 Usage characteristics, limitations

- The distance between points is shown to the hundredths decimal place up to 100 NM and to the tenths decimal place thereafter.
- A maximum of 50 points can be inserted, and the maximum measurable distance between two points is 240.0 NM.
- The TTG value is rounded to the nearest decimal place. Therefore, the displayed total TTG may not equal the sum of all the TTGs.
- The TTG is measurable to 99:00. If the TTG is higher, the TTG indication is ">99:00".
- The ship's speed must be at least 0.5 kn to calculate TTG.
- The divider cannot be used in latitudes higher than 85°.
- In the split screen display, the divider is viewable on both the main and sub views, but is operable only on the main view.

15.10.3 How to deactivate and erase the divider

Get into the Voyage navigation or Voyage planning mode then right-click the screen to show the context-sensitive menu. Select [Clear Divider].

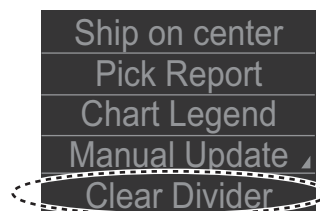

15.10.4 How to select the calculation method for the divider

The range calculation method for the divider can be selected to Rhumbline or Great Circle. Do as follows to select a calculation method.

1. Open the menu, then select [NAV Tools] and [Geometry] to show the [Geometry] page.

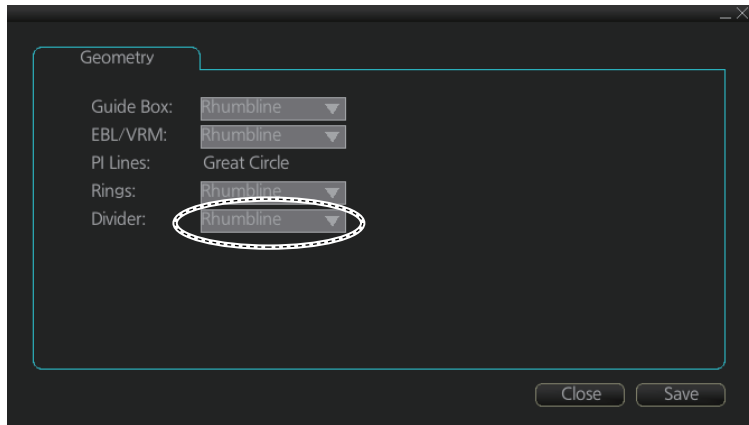

2. Select [Rhumbline] or [Great Circle] with the drop down list box for [Divider].
3. Click the [Save] button to save the setting, then click the close button to finish.

16. NAVIGATION SENSORS

16.1 CCRS

This chart radar employs a Consistent Common Reference System (CCRS) for the acquisition, processing, storage and distribution of sensor information. The CCRS ensures that all parts of the system uses the same source and values, e.g., speed through water, heading, etc. The illustration below shows the CCRS diagram.

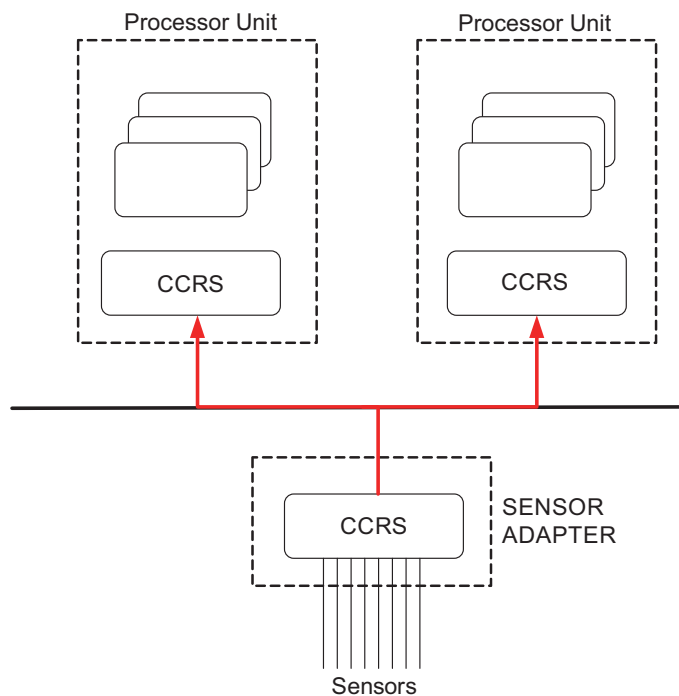

The CCRS process NMEA0183 and IEC 61162-1 sentences. No other types of data (video signals, etc.) are processed.

Check for validity, legitimacy

The system checks received sentences for validity and legitimacy.

Validity check: A sentence's checksum, status (A/V), Mode indicator and setting values are checked. (If checksum error is found, the sentence is disaffirmed.)

Legitimacy check: The range and accuracy of a sentence is checked.)

If the check for both is OK a valid flag results. If either is invalid, the invalid flag is given.

Types of CCRS

There are two types of CCRS: System and Local. The System CCRS integrates all navigation devices. In the Local CCRS each navigation device operates independently.

Representative sensors

If the system has multiple like sensors, the CCRS selects the representative sensor. Generally, the system uses common representative sensors; however, independent representative sensors (local representative sensors) can also be used.

16.2 How to Select Navigation Sensors

The operator can select navigation sensors to use for navigation and view their current values on the applicable page in the [System Sensor Setting] and [Local Sensor Setting] menus. To access these menus, right-click the Sensor information, datum box then click [Select Sensor] followed by [Setting].

The descriptions in this section show the sensor menus in the radar mode. The sensor menus in the chart mode mirror those in the radar mode, although the layout is different. Any change made in a sensor menu is reflected to the companion sensor menu, to synchronize the data between the modes.

16.2.1 Sensors menu description

[HDG] page (Local Sensor)

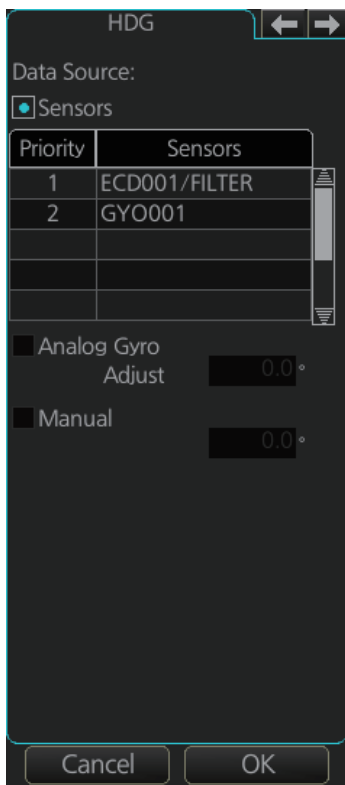

[Sensors]: Select the heading sensor to use.

[Analog Gyro]: No use.

[Manual]: Set heading manually when there is no heading sensor available. (Not shown on IMO type.)

[Gyro Correction]: Set correction manually for the heading value. (Not available with the [System Sensor Setting] menu.)

[SPD] page (System Sensor)

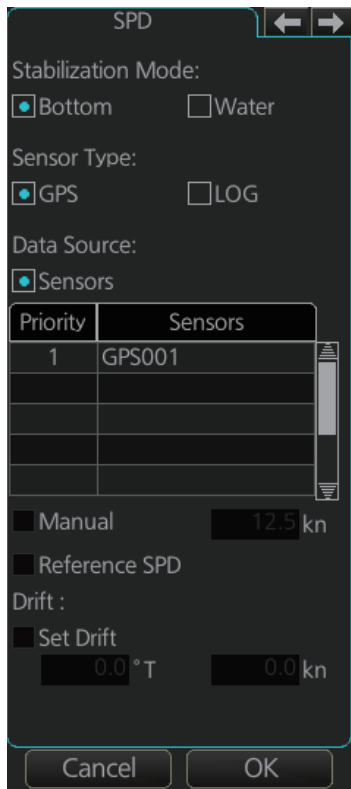

[Stabilization Mode]: Select the water stabilization mode: Select [Bottom] for ground stabilization, or select [Water] for sea stabilization.
 [Sensor Type]: Select [GPS] in case of a GPS navigator, or [LOG] for speed log.
 [Data Source]: Check [Sensors] to use a sensor in the [Sensors] list, or click [Manual] to enter speed manually. Use [Manual] when no speed source is available.
 [Manual]: Input speed manually. Check [Water] in [Stabilization Mode] and deactivate the AIS function to enable entry.
 [Reference SPD]: Check to use radar as the source for speed and course. (Only available with the Local Sensor Setting and checking [Bottom] in [Stabilization Mode].)
 [Set Drift]: Check the [Set Drift] checkbox to manually set speed and course of drift. Note that you can select manual drift only if you check [Water] in [Stabilization Mode].

Angle = Difference between heading and COG
 Spd = Speed component of the drift vector
 Cse = Course component of the drift vector

Vector defined by (SOG and COG) is equal to vector sum of vectors defined by (SPD and HDG) and (set and drift).

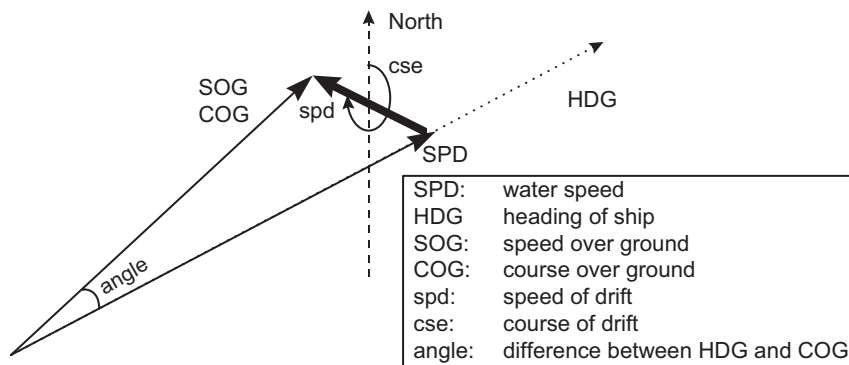

[COG/SOG] page

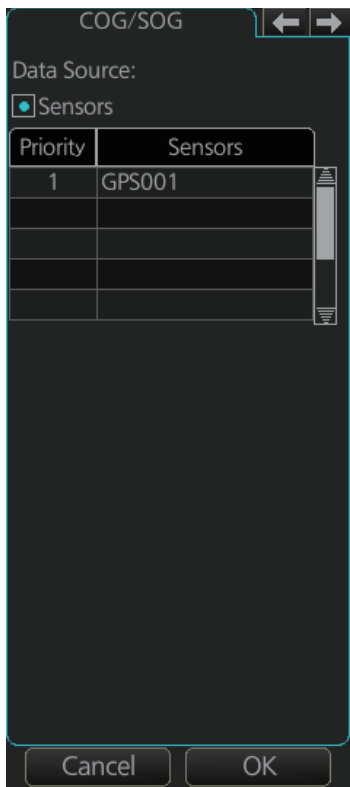

Select the source (GPS receiver) for speed over the ground and course over the ground.

[POSN] (Position) page



The sensor label (here, GPS001, GPS002) indicates the name of the sensor.

[Data Source]: Check [Sensors] to use a sensor in the [Sensors] list, or click [DR] to enter position manually. When the position source is changed based on priorities and signal validity to another position source, then you get the Alert 472 (ALF format: 10602,1) "Position Source Change".

[DR]: Check [DR] when no position source is available.

[Other Sensor] page

To show the [Other Sensors] page, open the menu and select [Other Sensor Settings] in the chart mode.

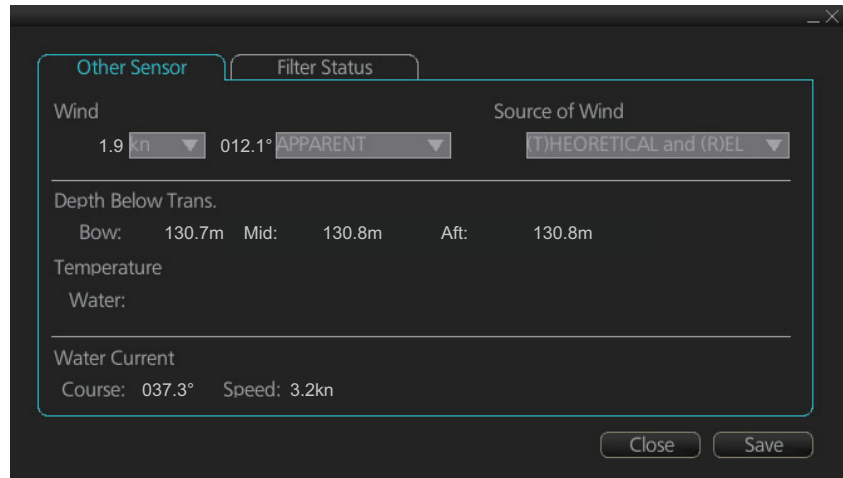

[Wind]: Select wind unit, wind reference, and wind source. See section 16.9.

[Depth Below Trans]: Depth from hull at bow and aft to bottom. A depth alert value may be entered to alert you when the depth is within the value set.

[Temperature]: Water surface temperature.

[Water Current]: Tide at own ship's position.

16.3 Source of Position

The figure below shows how source for position is chosen. The position sensors have either primary or secondary as input for their calculation. DGPS position sensors are considered more accurate than other position sensors.

The latitude and longitude position is shown at the top-right position on the chart radar display, and in the example below the position source is DGPS. Other indications that may be displayed in the position area are as follows:

- [DR]: Shown in yellow when position source is dead reckoning.
- [DGPS], [GPS]: Name of position source.

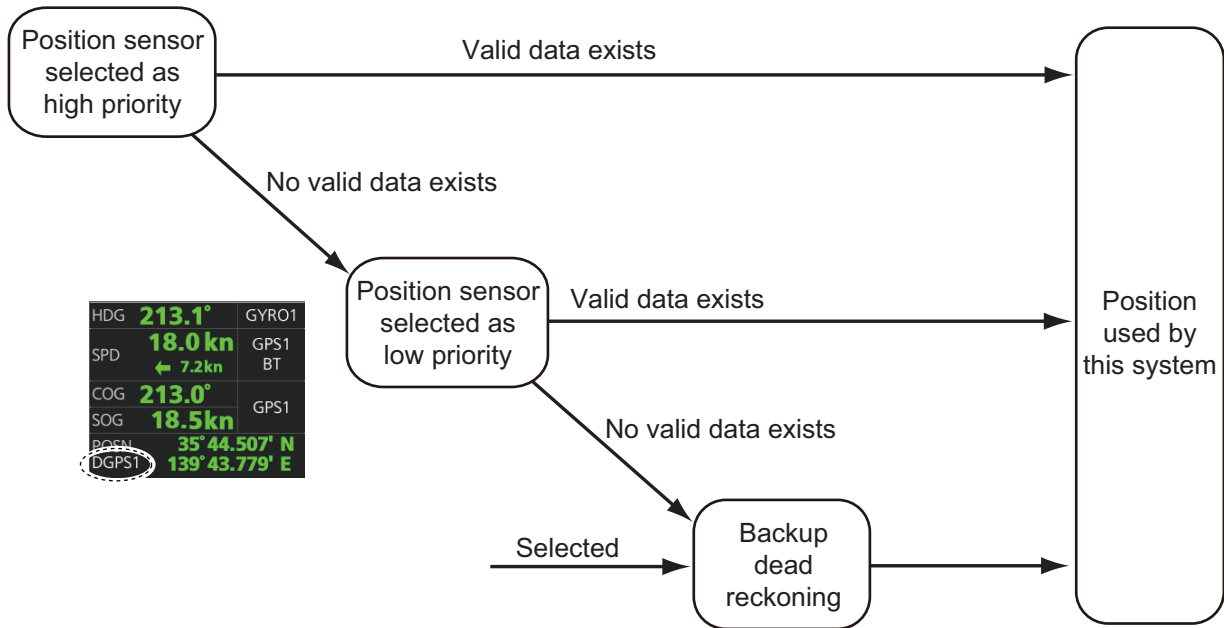

HDG	213.1°	GYRO1
SPD	18.0 kn	GPS1
	← 7.2 kn	BT
COG	213.0°	GPS1
SOG	18.5 kn	GPS1
DRSM	35° 44.507' N	
DGPS1	139° 43.779' E	

If the system changes the source of position because of lost sensor data, the system immediately generates the Alert 472 (ALF format: 10602,1) "Position Source Change".

16.4 Primary and Secondary Positions of Own Ship

This system displays position in one of four methods

- **CCRP position:** CCRP
- **Primary position:** Position generated by position source chosen as highest priority.
- **Secondary position:** Position generated by position source chosen as 2nd highest priority.
- **Pivot position:** Ship's pivot point position.

The position source for primary position of own ship is chosen as Primary on the [POSN] page of the [Sensor] menu.

The position source for secondary position of own ship is chosen as Secondary on the [POSN] page of the [Sensor] menu. Secondary position of own ship is not available as latitude/longitude value for the user.

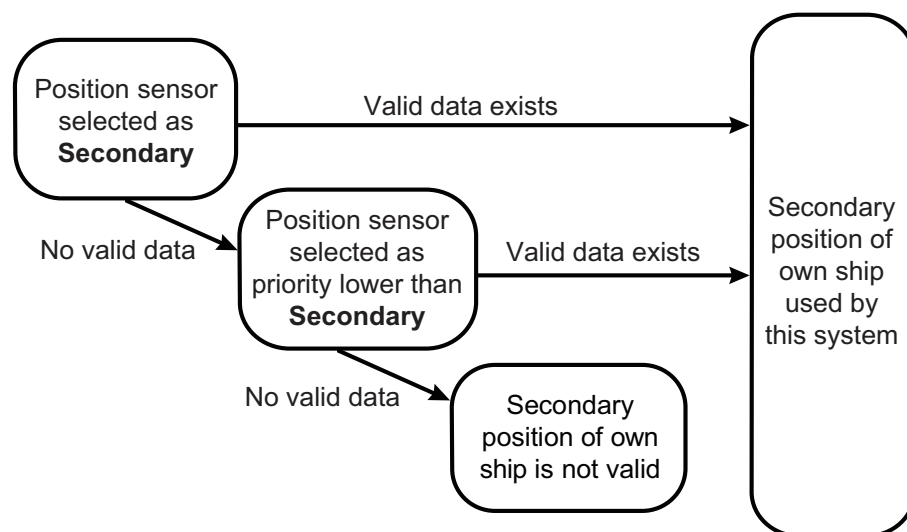

System, primary and secondary positions of your ship may be plotted on the chart radar display with the past tracks feature. You can control their visibility, etc. from the [Tracking] page of the [Symbol Display] menu, shown in the right figure. In this example, past tracks are plotted using the primary position-fixing equipment.

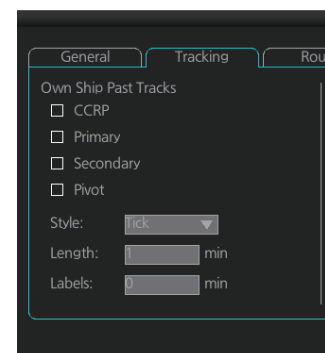

16.5 Source of Navigation Data

The figure below shows how various sources of navigation data are chosen. "SOG, COG" is speed over the ground and course over the ground, respectively. "SPD" is speed through the water. "Drift" is the difference between speed through the water and speed over ground.

Heading used by the system is shown at the top-right position on the chart radar display. In the example shown below, heading is received from a gyrocompass and it is shown without additional text, meaning the value is referenced to true North.

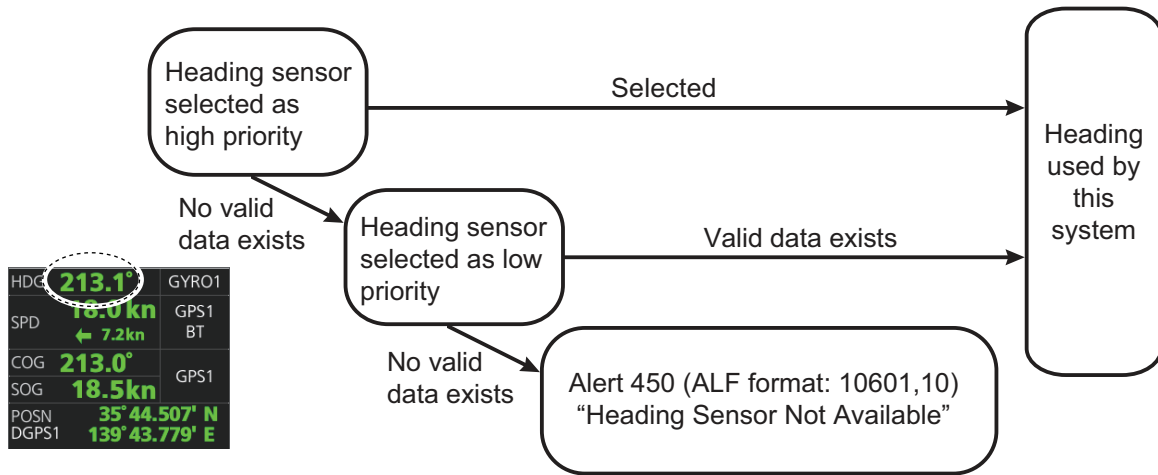

SOG/COG used by the system is shown at the top-right position on the chart radar display. In the example below, COG and SOG are from chosen position sensors and this is indicated with the text "GPS*" or "LOG*" (* is the number of sensors).

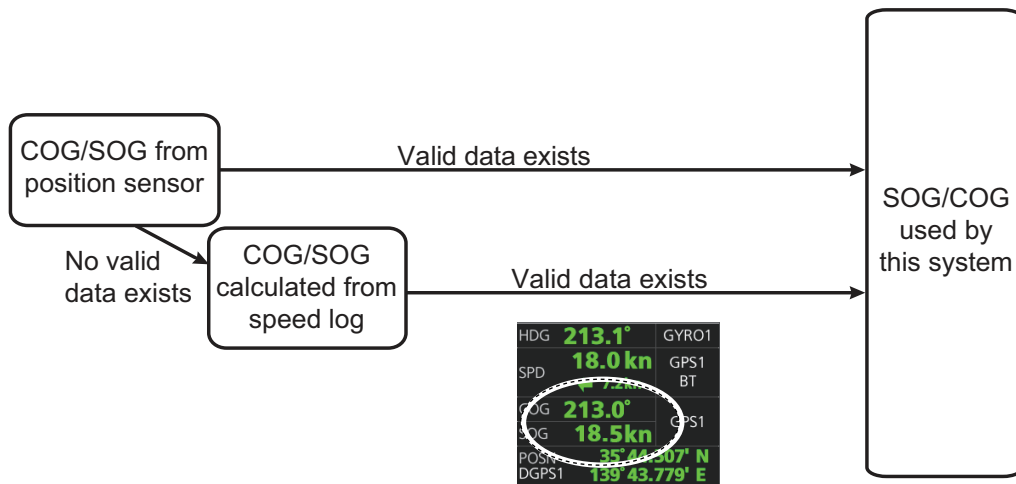

Speed used by the system is shown at the top-right position on the chart radar display. The figure below shows the source of water speed is used for drift calculation.

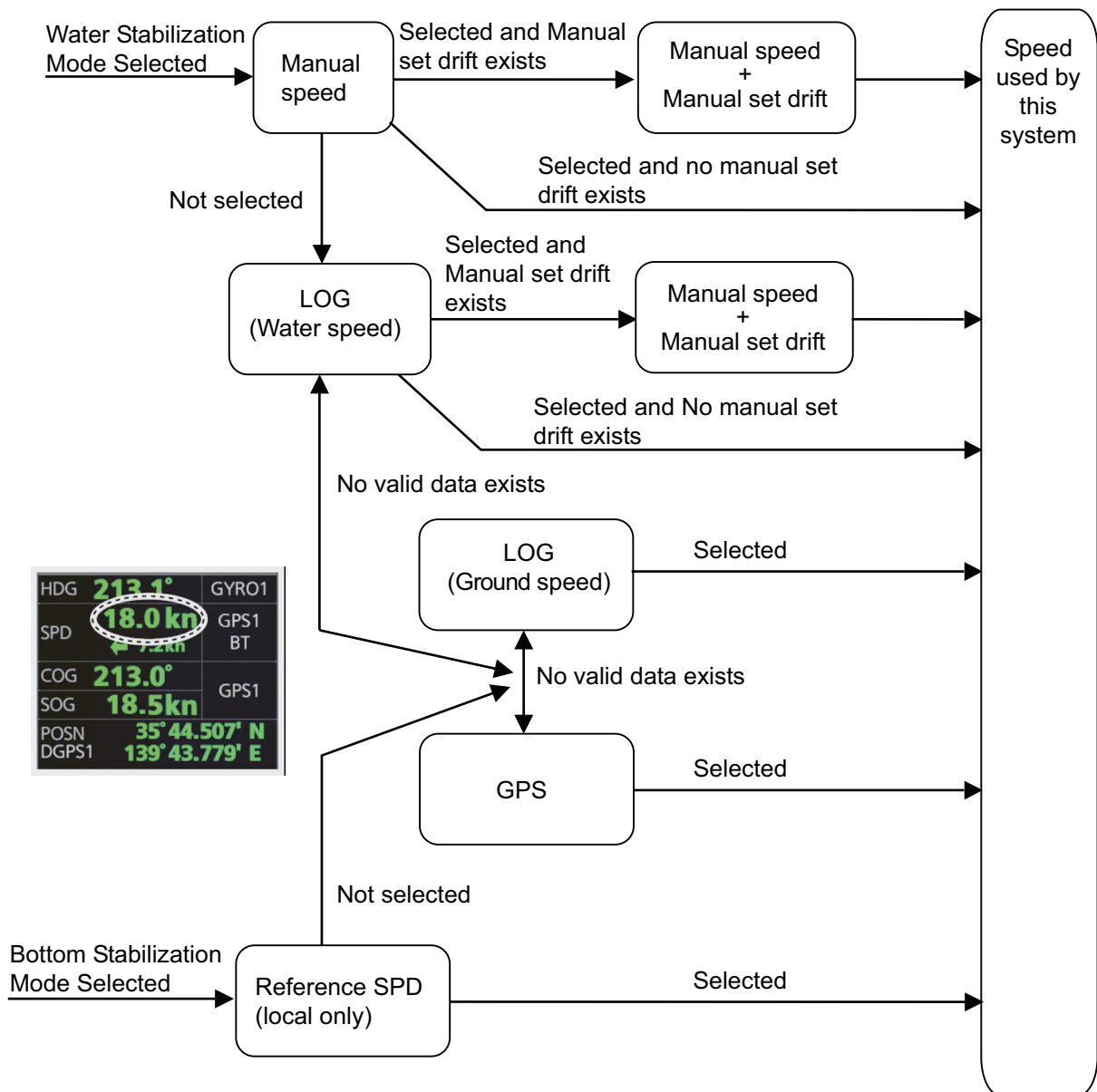

Alert related to SOG, COG, speed and heading components

It is possible that the operator has not chosen any speed or heading sensors, or that the chosen sensors do not have any valid values. This kind of a situation is critical for the system, because it cannot even perform dead reckoning.

When no heading source is available, the system generates the Alert 450 (ALF format: 10601,5) "Heading Sensor Not Available".

When no speed source is available, the system generates the Alert 453 (ALF format: 10601,6) "SDME Sensor Not Available". When no COG/SOG data is available, the system generates the Alert 279 (ALF format: 10601,3) "COG/SOG Not Available".

16.6 Switching of Sensor and Indication

When a sensor cannot be used because of some problem, the system automatically switches the sensor. When this occurs the name of the newly selected sensor appears in yellow.

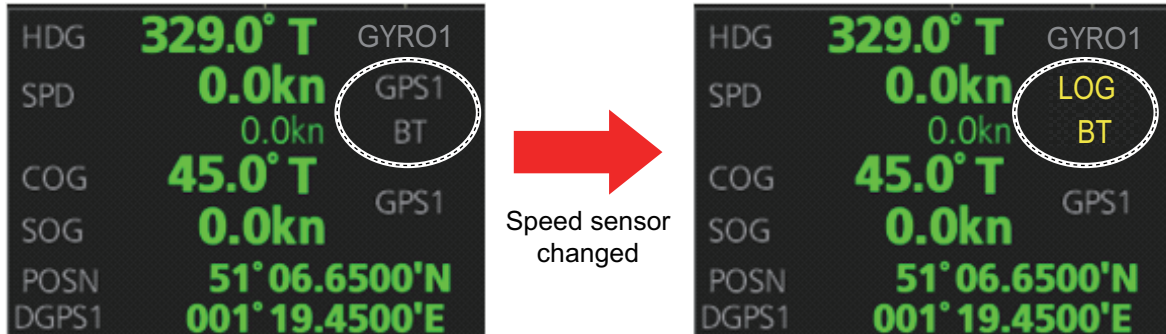

16.7 Filter Status

The ECDIS incorporates a filter that receives raw sensor data, checks sensor integrity and processes multiple sensor data to produce a continuous estimate of ship's position and motion.

By default, the filter uses data from all available sensors for filtering and integrity monitoring. The exception is heading data; only the selected heading device affects the output of the filter, but other heading sensors (including magnetic compasses) are used for integrity monitoring.

Sensors may be excluded manually or automatically. An excluded sensor participates in neither integrity monitoring or filtering. The filter automatically excludes a sensor from use if the sensor fails the first level of integrity check (for example, if a sudden jump is detected). If the actual integrity check fails for some reason and the filter is able to identify the faulty sensor, the faulty sensor is automatically excluded.

Sensor integrity is determined by: (1) monitoring the statistical accuracy of each sensor independently and analyzing the input values and using the information of the type of sensor, and (2) monitoring the difference between pairs of sensors. The system checks heading, rate of turn, position, COG/SOG and CTW/STW data for integrity, in accordance with INS regulations (IEC-61924-2). The result is either [Passed], [Doubtful], [Failed], [Excluded] or [Not Available].

The integrity check result appears in the following locations:

- [Local Sensor Setting] and [System Sensor Setting] menus. The figure below shows the result for the heading sensor GYRO1.

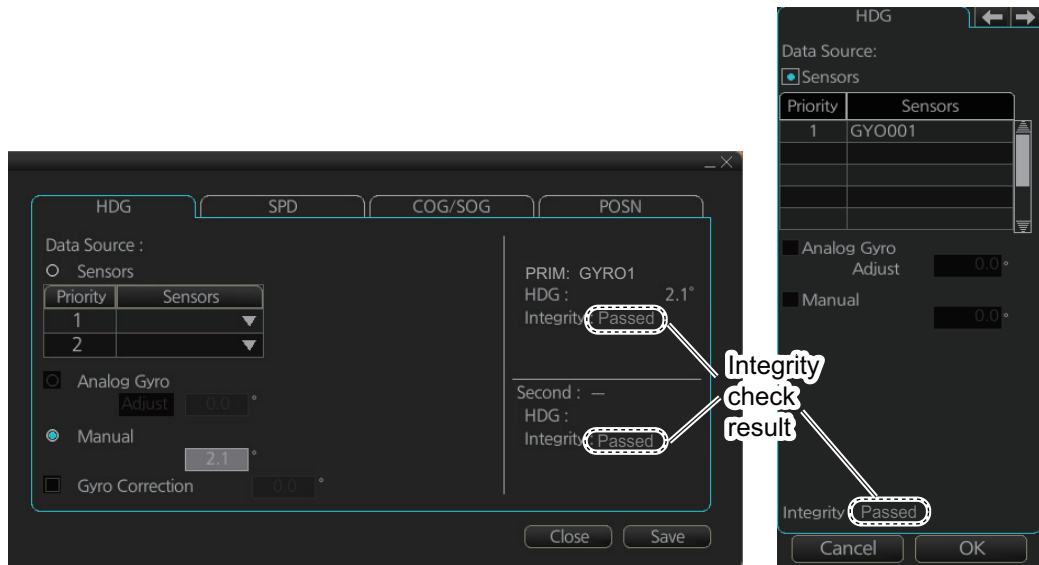

Chart for Radar mode

Radar mode

- [Filter Status] page in the [Other Sensor Setting] menu. See the next page.

Note: Depending on settings selected at installation, the integrity check result colors can be changed.

[Passed]: Data is available for comparison and data is normal.

[Low Accuracy]: Data signal strength is low, but data is normal.

[Doubtful]: Data is not available for comparison, but data is normal.

[Failed]: Data is available (or not available) for comparison and data is abnormal.

[Excluded]: Value is greatly changed.

[Not Available]: Sentence is abnormal or improper.

For heading data, If there is only one gyro, the judgment is "Doubtful" when the ship is stopped because there is no COG for comparison. When the ship begins to move, the judgment is changed to "Passed" because there is COG for comparison.

The methods of integrity monitoring are outlined in the table below.

Sensor	Comparison
Position	<ul style="list-style-type: none"> • Comparison with other position sensors. • Comparison with dead reckoning position.
Heading	<ul style="list-style-type: none"> • Comparison with other heading sensors. • Comparison with a COG sensor (used only if other heading sensors are not available and if COG is high enough).
Speed over the ground	<ul style="list-style-type: none"> • Comparison with other SOG sensors. • Comparison with water speed sensors is a secondary option (used only if other SOG sensors are not available).
Speed through the water	<ul style="list-style-type: none"> • Comparison with other STW sensors. • Comparison with STW sensors is a secondary option (used only if other STW sensors are not available).
Rate of turn	<ul style="list-style-type: none"> • Comparison with other rate of turn sensors.

The status and integrity of all sensors can be monitored from the [Filter Status] page in the [Other Sensor Settings] menu. Sensors can also be unselected and the filter reset from this page.

Sensor	Data	Status	Integrity	Comparisons
GP0001	POSN	Selected	Passed	DR(P)
GP0001	SOG/COG	Selected	Passed	VD0001(P)
HE0001	HDG	Selected	Passed	GP0001(P)
HE0001	ROT	Selected	Doubtful	
VD0001	SOG/COG	Selected	Passed	GP0001(P)
VD0001	STW/CTW	Selected	Passed	GP0001(P),VD0001(P)

The [Status] column indicates sensor status as follows:

- [Selected] (sensor selected for use in filter)
- [Unselected] (sensor not used in filter)
- [Not Available] (no sensor information)
- [Excluded] (automatically excluded sensor)

The [Integrity] column indicates sensor integrity as either [Passed] or [Failed] . The integrity evaluation is [Doubtful] when there are no other sensors to compare with.

The [Comparisons] column shows the sensors compared and the integrity evaluation of compared sensors in parentheses. Using the illustration above as an example, SOG/COG data fed from GP0002 is compared with the sensors GP0001 and VD0001. The integrity evaluation for the compared sensors is [Passed].

To unselect a sensor manually, select the sensor from the drop-down list at the bottom left corner of the page, click the [Unselect] button then click the [Save] button. [Unselected] appears in the [Status] column. To reselect an unselected sensor, select the sensor from the drop-down list, click the [Select] button. [Selected] appears in the [Status] column.

The [Reset Filter] button functions to recover from sensor failure. When the button is operated:

- Automatically excluded sensors are re-included.
- All data history is erased.
- Output values are re-estimated using new data.
- Integrity monitoring is restarted using new data.

Note 1: The filter can also be reset from the context-sensitive menu. Right-click anywhere in the Sensor information box to show the context-sensitive menu then select [Filter Reset].

Note 2: When the filter is reset for this system, all networked equipment's filters are reset.

16.8 Position Alignment

The position alignment feature functions to fine tune ship's position by using radar echo target and chart material.

If position alignment is in use, the Alert 640 (ALF format: 10803) "Chart Align: Over 30 Min." is generated every 30 minutes to remind the user to align position. The alert is automatically erased in 10 seconds.

Note: This feature is effective with the chart radar unit whose data source for FILT is assigned the highest priority.

16.8.1 How to align position

If the radar echo targets' symbols are not positioned correctly on the chart, there is either position error or gyro error or some combination of these errors.

Position may be aligned on the chart radar display by moving own ship position or by moving radar target position. To align position, get into the Voyage navigation mode, click the [Offset] button at the top-right position on the screen. (You are asked if you want to align position; click the [Yes] button to proceed.) Put the cursor on the correct position then click. The amount of offset, in bearing and range, appears to the right the [Offset] button.



The latitude and longitude position indication is shown in yellow characters when the position align feature is active.

16.8.2 How to cancel position alignment

Click the [Offset] button to cancel the position offset.

16.9 Wind Sensor

The chart radar can display and output wind data in the following three formats:

Apparent: Windmeter-measured wind speed and direction.

Wind angle reference: Heading

North: True wind angle, true wind speed

Wind angle reference: True North

Theoretical: True wind angle, true wind speed

Wind angle reference: Heading

The illustration below shows wind speed and direction with given ship data.

The wind values are as shown below.

Ship information:

COG: 60°

SOG: 8.7 kn

Heading: 45°

16. NAVIGATION SENSORS

	Wind angle	Wind speed
Apparent:	345°	10 kn
North:	330°	5 kn
Theoretical:	285°	5 kn

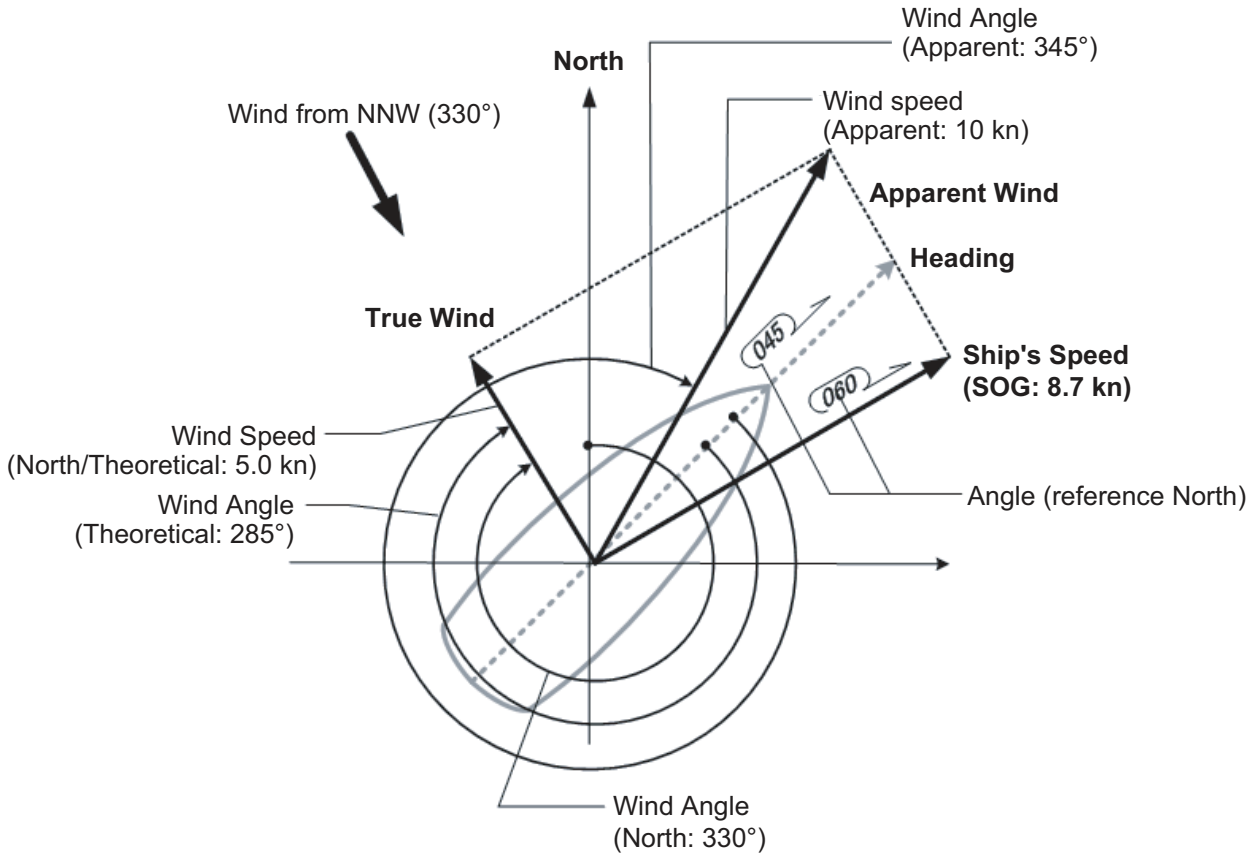

Apparent, North (true wind referenced to North), Theoretical (true wind referenced to heading) may be selected from the [Other Sensor Settings] menu. If the wind indication is not accurate; for example, the wind is blowing from the North but the wind direction displays otherwise, check if the format is Theoretical. If it is, switch to another format.

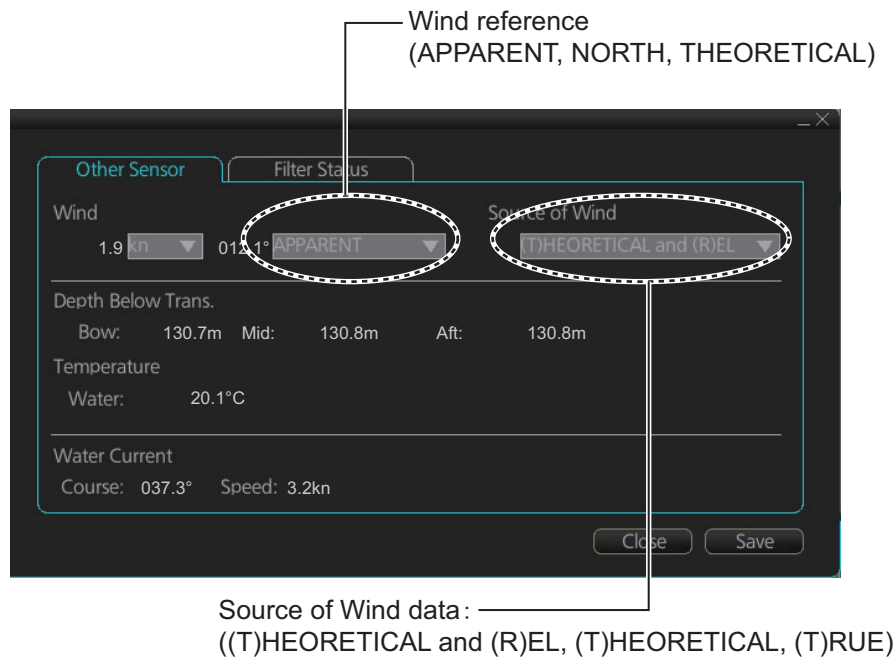

16.10 Depth Sensor

The depth output from a depth sensor (for example, echo sounder) is shown on the [Other Sensor] page in the [Other Sensor Settings] menu.

The content of the [Other Sensor] page depends on sensors connected.

In this example there are three transducers (bow, mid and aft) installed.

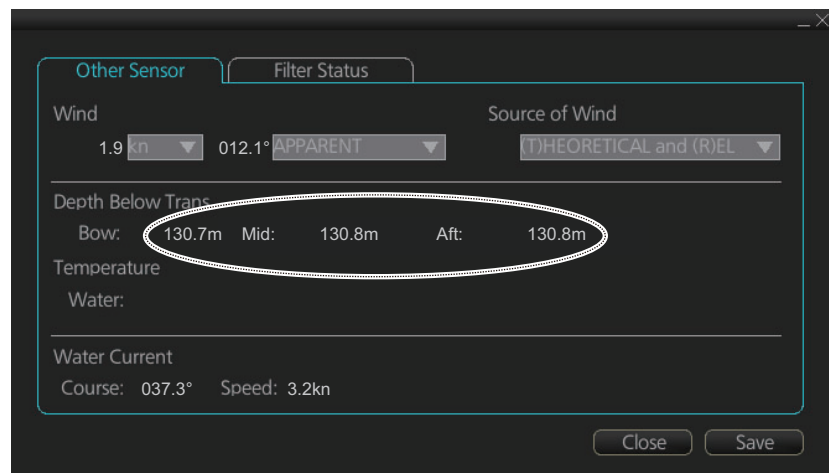

The system displays depth value as depth below the transducer. If required, you can get an alert when the measured depth is less than the "Echo Alarm Limit" setting at the [UKC] page in the [Overlay/NAV Tools] box. The system generates the Alert 485 (ALF format: 10801) "Depth Limit".

This page is intentionally left blank.

17. AIS SAFETY, NAVTEX MESSAGES

17.1 AIS Safety Messages

You can send and receive messages via the VHF link, to a specified destination (MMSI) or all AIS-equipped ships within communication range of your ship. Messages can be sent to warn of safety of navigation, for example, an iceberg sighted. Routine messages are also permitted. Short safety-related messages are only an additional means to broadcast safety information. They do not remove the requirements of the GMDSS.

17.1.1 How to send an AIS safety message

Note: If you are using the Trackball Control Unit RCU-026, display the software keyboard ([DISP] button, [Keyboard], [ON] on the InstantAccess bar™) before starting this procedure.



1. In the Voyage navigation mode, click the [MSG] and [Safety MSG] buttons on the InstantAccess bar™ to show the [Message] dialog box.

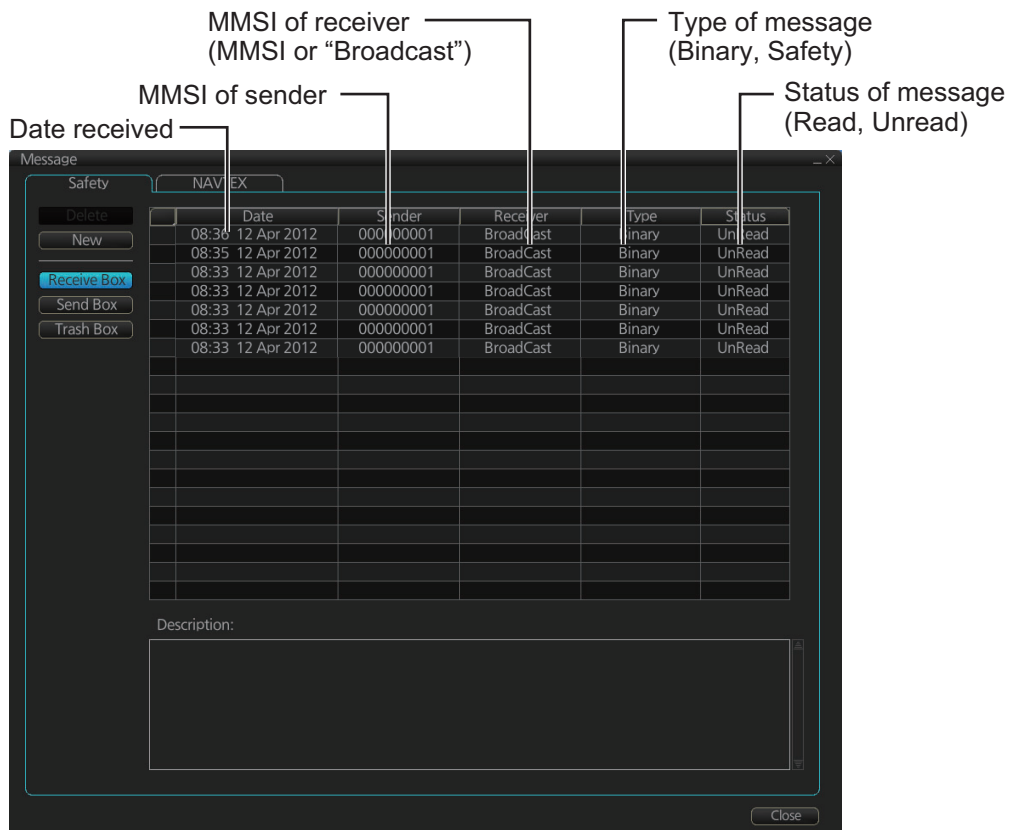

The screenshot shows the "Message" dialog box with a table of messages. Annotations with lines pointing to specific columns in the table are as follows:

- MMSI of receiver (MMSI or "Broadcast")** points to the "Receiver" column.
- Type of message (Binary, Safety)** points to the "Type" column.
- Status of message (Read, Unread)** points to the "Status" column.
- MMSI of sender** points to the "Sender" column.
- Date received** points to the "Date" column.

Date	Sender	Receiver	Type	Status
08:30 12 Apr 2012	000000001	BroadCast	Binary	UnRead
08:35 12 Apr 2012	000000001	BroadCast	Binary	UnRead
08:33 12 Apr 2012	000000001	BroadCast	Binary	UnRead
08:33 12 Apr 2012	000000001	BroadCast	Binary	UnRead
08:33 12 Apr 2012	000000001	BroadCast	Binary	UnRead
08:33 12 Apr 2012	000000001	BroadCast	Binary	UnRead
08:33 12 Apr 2012	000000001	BroadCast	Binary	UnRead

Additional UI elements include "Delete", "New", "Receive Box", "Send Box", "Trash Box", "Description:" text area, and a "Close" button.

17. AIS SAFETY, NAVTEX MESSAGES

- Click the [New] button.
- At [Send to], select where to send the message. Select [Broadcast] to send the message to all AIS-equipped ships within communication range, or select [MMSI] and enter the MMSI of the ship where to send the message.
- At [Type], select the type of message, [Safety] or [Binary] (routine).
- At [Channel], select the channel to use to send the message.
- At [Description], enter the text of your message. The no. of characters available depends on the type of message.
Safety message broadcast: 90 characters
Binary message broadcast: 86 characters
Safety message addressed to MMSI: 85 characters
Binary message addressed to MMSI: 80 characters
- Click the [Send] button to send the message.

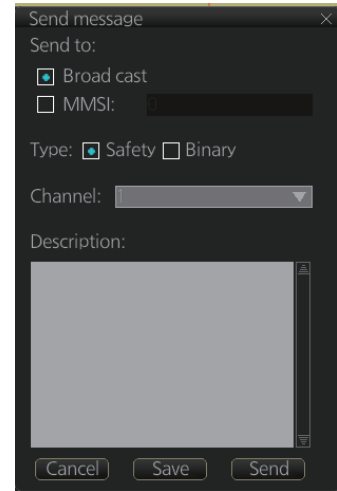

17.1.2 How to display received and sent AIS safety messages

When an AIS message is received, the Alert 539 (ALF format: 10540,1) "AIS Message Received" appears. Do the following to view the message.

- In Voyage navigation mode, click the [MSG] and [Safety MSG] buttons on the InstantAccess bar™.
- Click the [Receive Box] or [Send Box] button as appropriate.
- Click a message to view its contents.

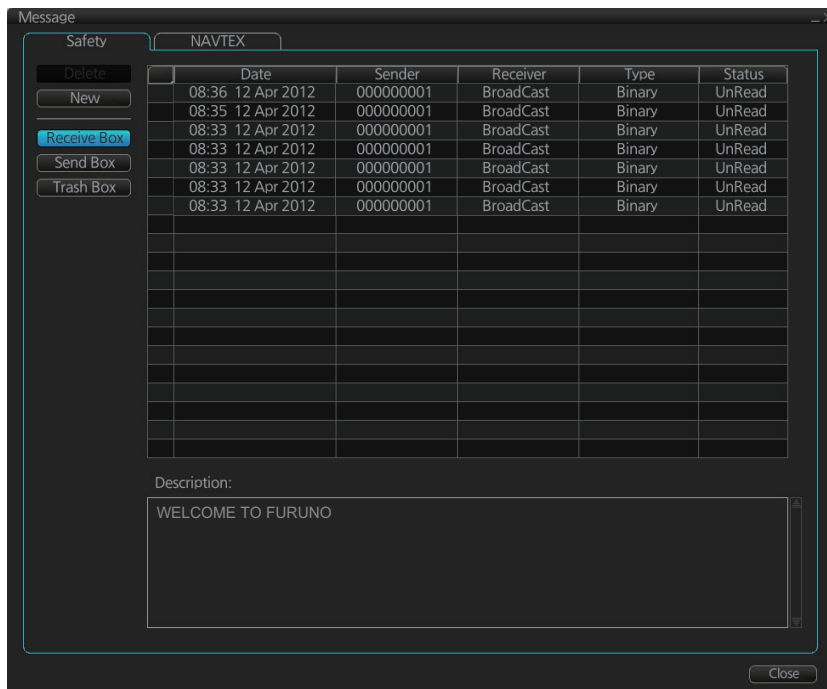

17.1.3 How to delete received and sent AIS safety messages

Note: A large amount of messages may take some time to delete.

How to delete a received or sent message

1. Click the [Receive Box] or [Send Box] as appropriate.
2. Click the box that is before the date to show a check mark. (All messages can be checked or unchecked with the context-sensitive menu. Right-click the box to the left of "Date" then select [Check All] or [Uncheck All] as applicable.)
3. Click the [Delete] button.

How to delete received or sent messages permanently

1. Click the [Trash Box] button.
2. Click the box that is before the date to show a check mark. (All messages can be checked or unchecked with the context-sensitive menu. Right-click the box to the left of "Date" then select [Check All] or [Uncheck All] as applicable.)
3. Click the [Delete] button.

17.2 Navtex Messages

Navtex (Navigational Telex) is an international automated medium frequency direct-printing service for delivery of navigational and meteorological warnings and forecasts, as well as urgent marine safety information to ships.

Navtex messages can be received and read.

The [Receive Box] can store up to 500 messages. When the [Receive Box] is full and a new message is received, the system automatically deletes messages, in order, from the oldest message.

Note: If the message "Database access failure occurred. NAVTEX messages cannot be received." appears, your Navtex database may be corrupted. Consult your dealer for advice.

17.2.1 How to receive Navtex messages

To display a received NAVTEX message, do the following:

1. In Voyage navigation mode, click the [MSG] and [NAVTEX MSG] buttons on the InstantAccess bar™.
2. Click the message to view. The text of the message appears in the [Description] box.

Message protection status:
P = Protected
Blank = Un-protected

Date received

Frequency/ Message ID

Type of message

Message status: Read or Unread

Where coordinates are included in the message, the latitude and longitude are displayed here. The chart is also appropriately marked with the MSI marker.

Where the selected message has a date range, the dates are displayed here.

Date	Code	Message Type	Status
17:01 28 Jun 2016	518kHz/GA50	Navigational warning	Read
17:00 28 Jun 2016	518kHz/GA53	Navigational warning	Read
15:07 28 Jun 2016	518kHz/GB88	Meteorological warning	Read
15:04 28 Jun 2016	518kHz/HB73	Meteorological warning	Read
17:27 27 Jun 2016	518kHz/IA77	Navigational warning	Read
17:25 27 Jun 2016	518kHz/IA88	Navigational warning	Read
17:12 27 Jun 2016	518kHz/HA37	Navigational warning	Read
17:05 27 Jun 2016	518kHz/GA47	Navigational warning	Read

Selection column

Filter by Date
Filter by Distance
Distance from Own Ship: 100 NM

Date Range(UTC):
From 30 Jun 2016 to 30 Jun 2016 Clear

Latitude	Longitude
1 34° 32.000' N	135° 05.000' E

Description:
281700 UTC JUN 16
JAPAN NAVTEX N.W. NR 1357/16
OKINAWA SHIMA, EAST SOUTHEASTWARD.
GUNNERY, 2100Z TO 0900Z COMMENCING DAILY

- You can filter the displayed messages.
 - To filter by date:** Enter the date range for displayed messages in the [Date Range(UTC)] input area. To clear the filter, click the [Clear] button. Check the Filter by Date box to activate the filter.
 - To filter by distance:** Check the [Filter by Distance] box to activate the [Distance from Own Ship] input area. Enter the appropriate distance (setting range: 1 to 100 NM).
- To protect a message, or remove the protection, click the protection status column for the message. When removing protection, the confirmation window shown below appears. Select [Yes] or [No] as appropriate.
 - Note:** You can protect up to 50 messages. When you try to protect more than 50 messages, the message shown below appears.

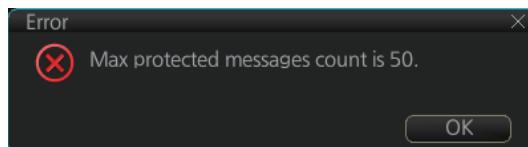
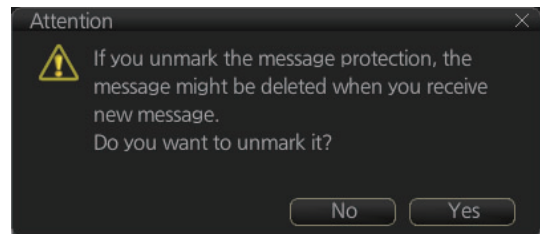

- You can check the settings for the Navtex receiver (if connected). Click the [Receiver] button to show the settings.

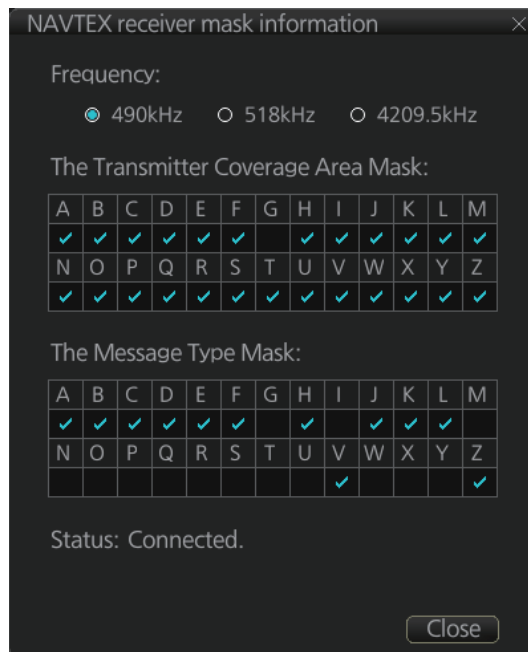

17.2.2 How to delete received Navtex messages

Note: A large amount of messages may take some time to delete.

How to delete received Navtex messages

- Click the [MSG] and [NAVTEX MSG] buttons on the InstantAccess bar™.
- Click the [Receive Box] button.
- Click the selection column (indicated in the figure at section 17.2.1) to show a checkmark in the box. (All messages can be checked or unchecked with the context-sensitive menu. Right-click the box to the left of "P" then select [Select All] or [Deselect All] as applicable.)
- Click the [Delete] button. The selected message is sent to the [Trash Box]. The [Trash Box] can hold up to 200 messages.

Note: If a protected message is selected for deletion, the confirmation message shown to the right appears. Click [Yes] to delete the protected message or [No] to cancel deletion.

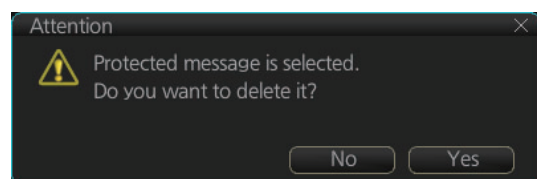

How to deleted received Navtex messages permanently

- Click the [MSG] and [NAVTEX MSG] buttons on the InstantAccess bar™.
- Click the [Trash Box] button.
- Click the selection column (indicated in the figure at section 17.2.1) to show a checkmark in the box. (All messages can be checked or unchecked with the context-sensitive menu. Right-click the box to the left of "P" then select [Select All] or [Deselect All] as applicable.)
- Click the [Delete] button.

This page is intentionally left blank.

18. TT AND AIS DISPLAYS

Tracked targets and AIS targets can be overlaid on the chart. Only the differences between the radar and chart TT and AIS displays are described here.

The data of received radar-tracked targets must have reference to ground. If the data does not meet that criteria, target vectors are not shown and the indications COG and SOG in the TT info data box show [missing].

18.1 TT Display

18.1.1 TT symbols

Refer to subsection 3.7.1.

18.1.2 TT symbol color and size

Do the following to select TT symbol color and size. Note that the color of the AIS symbol is also changed.

1. Click the [DISP], [SET] and [Symbol DISP] buttons on the InstantAccess bar™ to show the [Symbol Display] menu.
2. Click the [Targets] tab.

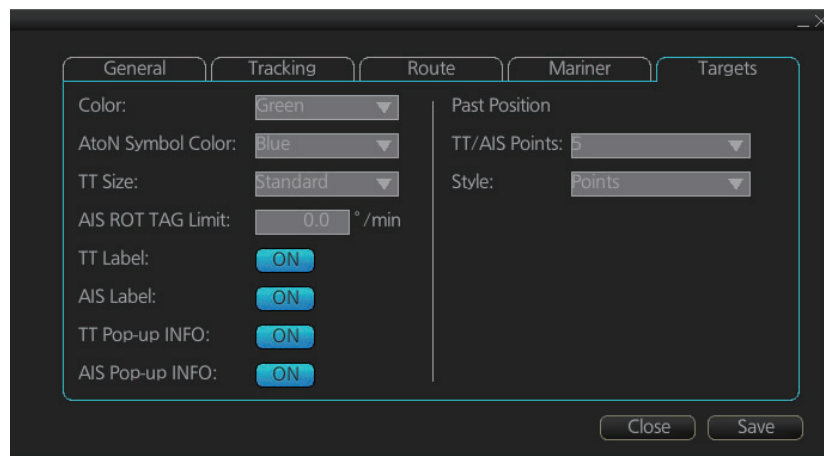

3. Select the color among, green, blue, black, magenta and brown, with the [Color] pull-down list.
4. Select the size from standard or small, with the [TT Size] pull-down list.

18.1.3 How to display tracked target data

Control Unit: Put the cursor on a target then push the **TARGET DATA** key.

Trackball module: Click the target for which you want to show its data.

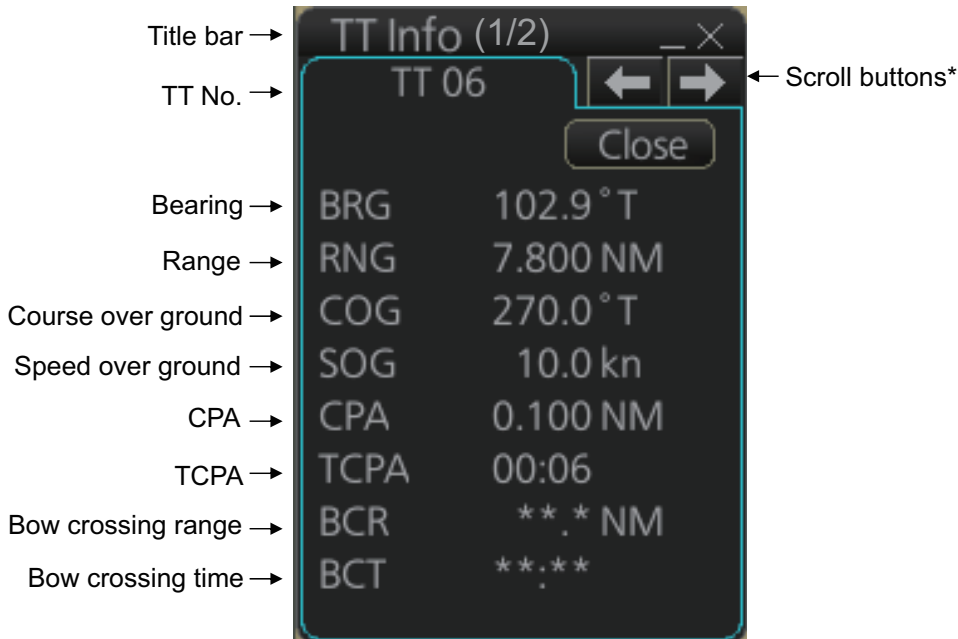

*: Scroll buttons appear only when there is more than one TT target's data displayed.

To erase data from a data box, click the close (X) button.

The basic target data display for a TT consists of the following information:

- Target's number. Target numbering starts from "01". When a target is erased the number will not be reused until the power is re-set or more than 200 targets are acquired.
- Bearing (BRG) and distance (RNG) of the target from own ship
- True speed (SOG) and true course (COG) of the target
- CPA and TCPA. A negative TCPA value means that you have already passed the closest point and the TT is going away from own ship.
- Bow Crossing Range (BCR) and Bow Crossing Time (BCT)

18.1.4 Past position point attributes

You can define past position point attributes for tracked targets by points and style.

1. Click the [DISP], [SET] and [Symbol DISP] buttons on the InstantAccess bar™ to show the [Symbol Display] menu.
2. Click the [Targets] tab.

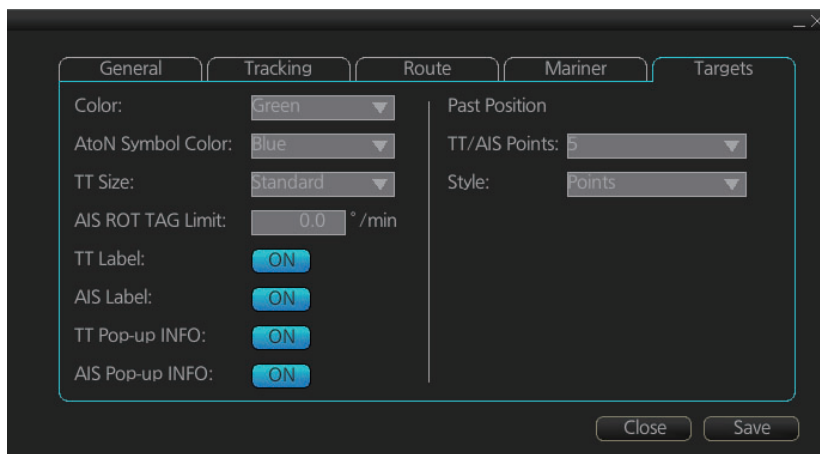

3. At [TT Points], select the number of points to show.
4. At [Style], select the style for the past position points. The choices are [Points] and [Points and Dots].

18.1.5 How to set the TT lost target filter

If you are in a congested area the lost target alert may sound against many AIS targets. In this case, you can prevent the alarm from sounding against TT that are beyond a certain range and/or smaller than a specific length.

1. Open the MENU and select [TT/AIS] and [Setting] then click the [Setting.2] tab.

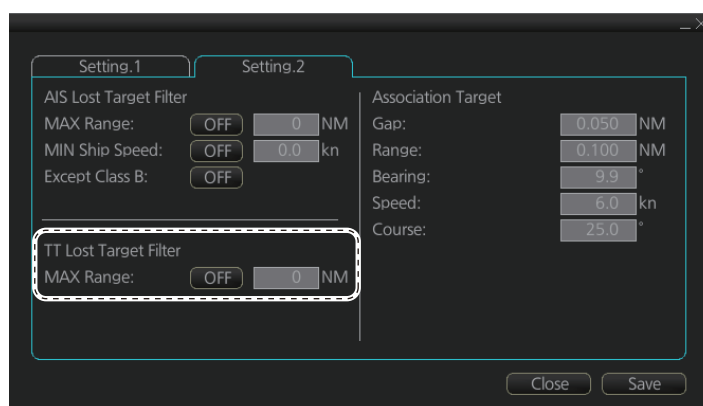

2. In the [TT Lost Target Filter] window, set the maximum range to track a target. [MAX Range]: The maximum range at which to track a lost target. A tracked target not within this range is not tracked.
3. Click the [ON/OFF] button to show ON or OFF as appropriate.

18.1.6 TT recording functions

Tracked target information is saved to the [Danger Targets] log. See section 19.5.

18.2 AIS Display

18.2.1 AIS symbols

Refer to section 4.3.

18.2.2 Voyage data

Before you embark on a voyage, set your navigation status, ETA, destination, draught and the number of persons onboard, on the [Voyage Data] page in the [NAV Status] menu. The data entered here is reflected to the AIS transponder.

1. Open the MENU then click both [NAV Status] in the [TT/AIS] menu and the [Voyage Data] tab.

2. Click the [Navigational Status] drop-down list then select your navigational status, from the list below.

- Underway using engine
- At anchor
- Not under command
- Restricted maneuverability
- Constrained by her draught
- Moored
- Aground
- Engaged in fishing
- Under way sailing
- Reserved for high speed craft
- Reserved for wing in ground
- Power driven vessel towing astern (regional use)
- Power driven vessel pushing ahead or towing alongside (regional use)
- Reserved for future use
- AIS-SART (active)
- Not defined

3. Enter the number of persons onboard (0-8191) at [Persons].
4. Enter ship's draught (0.0 - 25.5 (m)) at [MAX Draught].
5. Enter your ETA at [ETA].
[Day]: two digits; [Month]: Three-character abbreviation; [Year]: Four digits
6. Enter your destination at [Destination], using a maximum of 20 characters.
7. Use the [Cargo Type] pull-down menu to specify the type of cargo your vessel is carrying.
 - All ships of this type
 - Carrying DG, HS, or MP, IMO hazard or pollutant category X
 - Carrying DG, HS, or MP, IMO hazard or pollutant category Y
 - Carrying DG, HS, or MP, IMO hazard or pollutant category Z
 - Carrying DG, HS, or MP, IMO hazard or pollutant category OS
 - Reserved for future use (x4)
 - No additional information
8. Click the [Save] button to save the settings.

18.2.3 How to filter AIS targets

1. Right-click [AIS] on the [TT/AIS] page in the [NAV Tools/Overlay box], select [Setting] and open the [Setting.1] page.

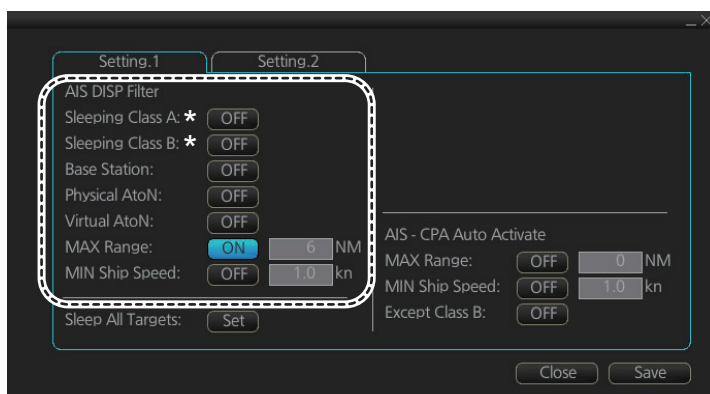

* Not shown on IMO- or A-type specification.

Note: You can also access the [Setting.1] page with one of the following methods:

- From the main menu, select [TT/AIS], [Settings] and [Setting.1].
- Click the TT/AIS settings radio button (indicated in the figure below) from the Overlay/NAV Tools box. (The radio button is not available when the TT/AIS page is displayed.)

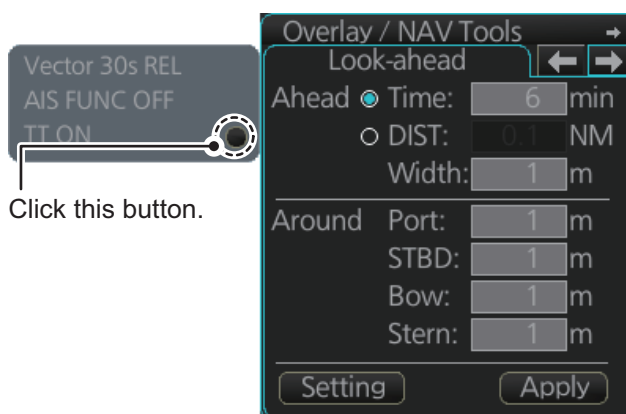

2. In the [AIS DISP Filter] window, set each item referring to the description below.
 - Click the buttons of [Sleeping Class A] and [Sleeping Class B] to show [OFF] or [ON] to hide or show those targets.
 - Click the button of [Base Station] to show [OFF] or [ON] to hide or show AIS base stations.
 - Click the button of [Physical AtoN] to show [OFF] or [ON] to hide or show Physical AtoN targets.
 - Click the button of [Virtual AtoN] to show [OFF] or [ON] to hide or show Virtual AtoN targets.
 - Set the maximum range with [MAX Range]. Any target beyond the range set here will not be displayed.
 - Set the ship speed for AIS targets, with [MIN Ship Speed]. Any AIS target whose speed is lower than that set here will not be displayed.

18. TT AND AIS DISPLAYS

- Click the [Save] button to save settings. Click the [Close] button to close the dialog box.

Note: AIS and tracked target viewing limitations are as follows:

AIS and tracked targets are displayed on top of chart 1:1,000,001 for S57 charts.

18.2.4 How to set conditions for automatic activation of sleeping targets

The AIS target automatic activation feature is turned on or off from the [TT/AIS] page in the [Overlay/NAV Tools] box. Set the conditions for automatic activation as shown below. The CPA/TCPA alarm must be active to get automatic activation of AIS targets.

Right-click [AIS] on the [TT/AIS] page in the [NAV Tools/Overlay box], select [Setting] and open the [Setting.1] page.

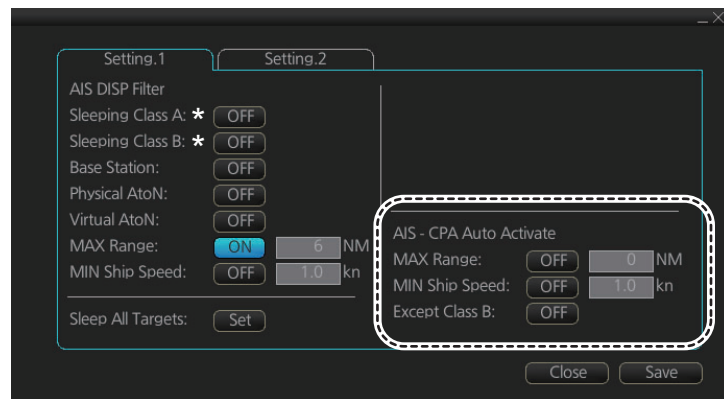

* Not shown on IMO- or A-type specification.

18.2.5 How to sleep all activated targets

You can sleep all activated targets. Right-click [AIS] on the [TT/AIS] page in the [NAV Tools/Overlay box], select [Setting] and open the [Setting.1] page. Click the button to the right of [Sleep All Targets] then click the [Set] button.

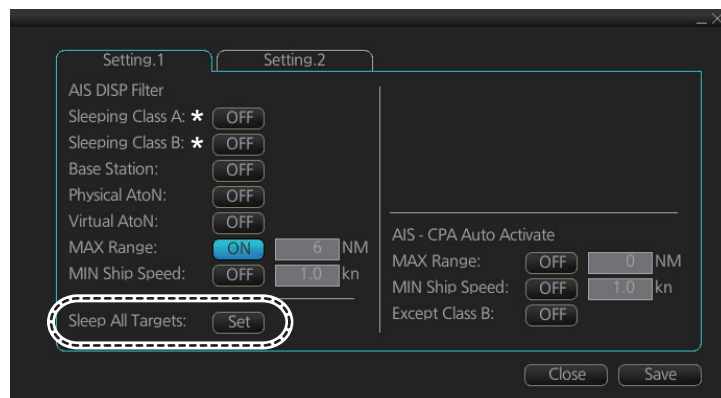

* Not shown on IMO- or A-type specification.

18.2.6 How to set the AIS lost target filter

You can select what AIS targets to exclude from the AIS lost target alert, on the [Setting.2] page in the [TT/AIS] menu.

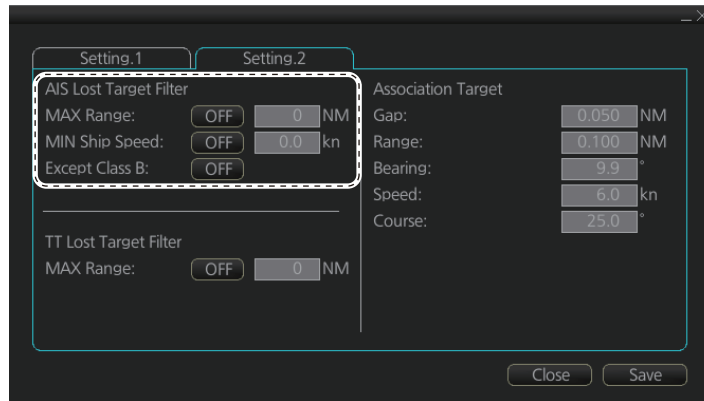

[MAX Range]: Set the max. range at which a target must be to be declared a lost target.

[MIN Ship Speed]: A tracked target whose speed is slower than set here does not trigger the lost target alarm.

[Except Class B]: Exclude class B AIS targets from the AIS lost target alert.

18.2.7 How to display AIS target data

Normal data

Put the cursor on an activated target then push the left button.

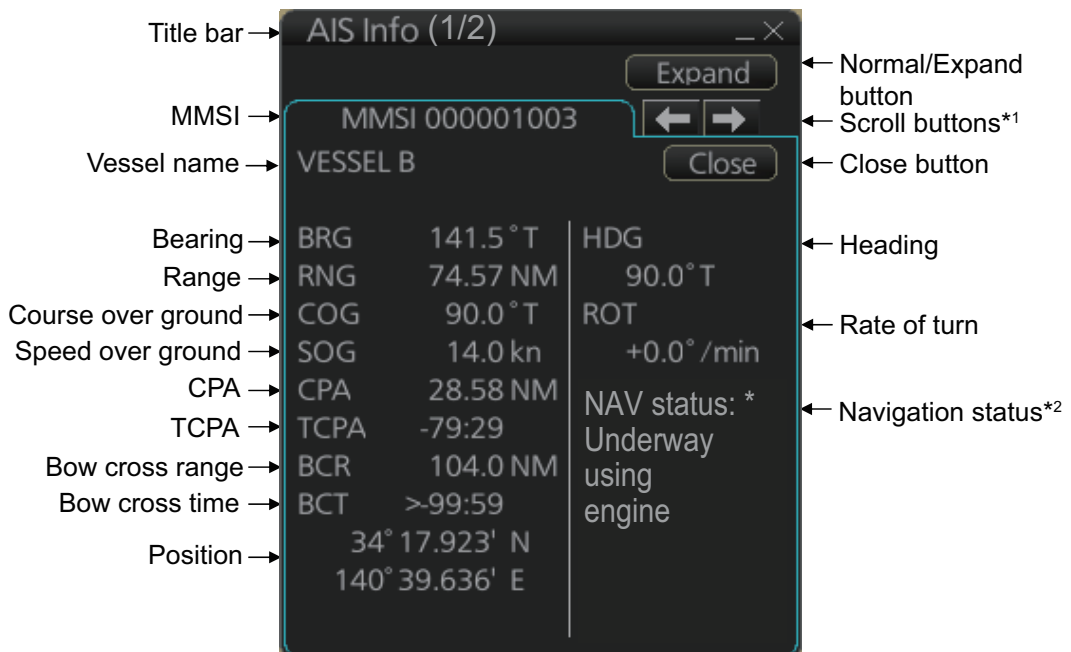

*1: Scroll buttons appear only when there is more than one AIS target's data displayed.

*2: [Altitude] appears when the selected target is an AIS SART aircraft.

Expanded data

Put the cursor on a desired AIS target then push the left button. Click the [Expand] button (level of detail) on the [AIS Info] box to show expanded AIS data.

The screenshot shows the 'AIS Info (2/5)' window with the following data:

- Title bar:** AIS Info (2/5)
- MMSI:** MMSI 000001003
- Vessel name:** VESSEL B
- Bearing:** BRG 141.6 ° T
- Range:** RNG 74.82 NM
- Course over ground:** COG 90.0 ° T
- Speed over ground:** SOG 14.0 kn
- CPA:** CPA 33.86 NM
- TCPA:** TCPA -78:41
- Bow cross range:** BCR 121.1 NM
- Bow cross time:** BCT >99:59
- Position:** 34° 17.922' N, 140° 39.777' E
- Position sensor:** POS sensor: GPS
- Position sensor accuracy (HIGH, LOW):** POS ACC.: HIGH
- Call sign:** Call sign: CALL2
- IMO No.:** IMO No.: IMO2222222
- Length:** Length: 300m
- Width:** Width: 11m
- Draught:** Ship draught: 12.2m
- Destination:** Destination: DESTINATION2
- ETA:** ETA: 31/DEC 23:59
- AIS version no.:** AIS version: 1
- Ship & Cargo type:** Ship and Cargo Type: Reserved for future use, Carrying DG, HS, or MP, IMO hazard or pollutant category Y
- Association condition:** Association: OFF

Annotations on the right side of the window:

- "Level of detail" button (points to 'Normal')
- Scroll buttons*1 (points to left and right arrows)
- Close button (points to 'Close')
- Heading (points to 'HDG')
- Rate of turn (points to 'ROT')
- Navigation status*2 (points to 'NAV status: Underway using engine')

*1: Scroll buttons appear when there are multiple AIS targets.

*2: Where the selected AIS target is an aircraft, the STATUS box shows the aircraft's altitude.

18.2.8 How to display own ship data

You can see own ship's data on the [Own Ship] page in the [NAV Status] menu. Open the menu then click both [NAV Status] in the [TT/AIS] menu and the [Own Ship] tab.

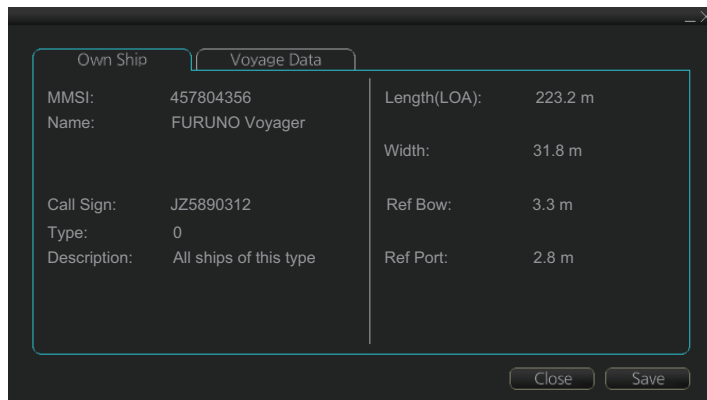

18.3 Association

An AIS-equipped ship is usually displayed by two symbols on the chart for radar display. This is because the AIS ship position is measured by a GPS navigator (L/L) whereas the radar detects the same ship by PPI principle (range and bearing relative to own ship radar antenna).

To avoid the presentation of two target symbols for the same physical target, use the "association" function. If target data from both AIS and TT are available and if the association criteria are fulfilled, either the AIS or TT symbol is presented according to the association method selected.

Association will not happen between AIS and TT if the AIS target is sleeping or the AIS target is lost.

All association settings, including ON/OFF, can also be controlled from the radar mode, with the [TT/AIS] setting box (see section 4.14). All settings are mutually shared.

18.3.1 How to select association method

Click the location circled below to show "<" to select AIS symbol for associated target, or ">" to select TT symbol for associated target. This setting overrides the corresponding item on the [TT/AIS] menu. To turn off association, click the location to remove the arrow.

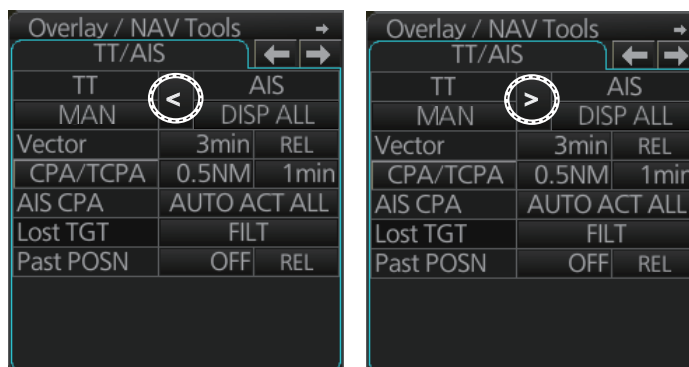

Note: You can also select the method by right-clicking the location. Click desired association method.

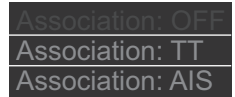

18.3.2 How to set the conditions for association

To set the criteria for association, right-click [AIS] on the [TT/AIS] page in the [NAV Tools/Overlay] box, select [Setting] and open the [Setting.2] page. For setting details, see subsection 4.14.2.

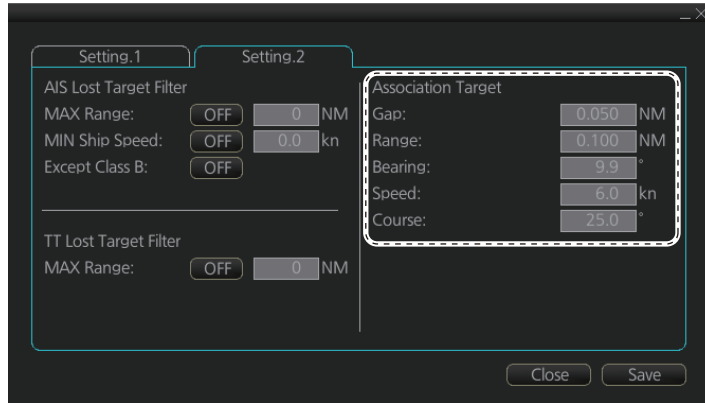

19. RECORDING FUNCTIONS

The chart radar records various voyage-related items like movement and position of own ship and dangerous radar targets (from Radar). These items are recorded in the following logs:

- Update log:** Records the install and update history for the ENC, ARCS and C-MAP charts (see section 7.12).
- Event log:** Records user events and position events.
- NAV log:** Records entire voyage (i.e., a sailing of a route from first point to the last, also MOB data), details (position, speed and course every minute), chart usage (information on charts used for display).
- Target log:** Records dangerous TT, AIS.
- Alert log:** Records alerts generated by the system (see section 20.6).
- Route transfer log:** Records sent and received route-related communications.

19.1 How to Record User, Position Events

This equipment can save/show a maximum of 2,000 events.

19.1.1 User events

A user event is a comment about an event (weather, etc.). You can show user events on the chart area. Open the [Tracking] page of the [Symbol Display] menu show or hide the events.

To record a user event:

1. Get into the Navigational or Voyage planning mode then click the [Log], [Event Log] and [User Event] buttons on the InstantAccess bar™ to show the [Record User Event] window.
2. Enter a comment. Click the [OK] button to finish and close the text box.

An event marker (☑) appears at your position and the event is recorded to the [Voyage] log.

To view the comment entered for an event, put the cursor on the event then left click to show the [Event Information] window.

Note: The [Event Information] window is shown with the [CHART for RADAR] mode.

The window shows the name of the event ([UserEvent]), time and date of entry, latitude and longitude position of the event and comment. Note that the comment can be edited from this window. Edit the comment then click the [OK] button to save.

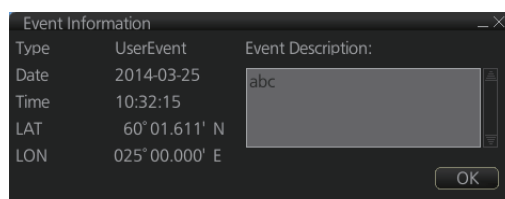
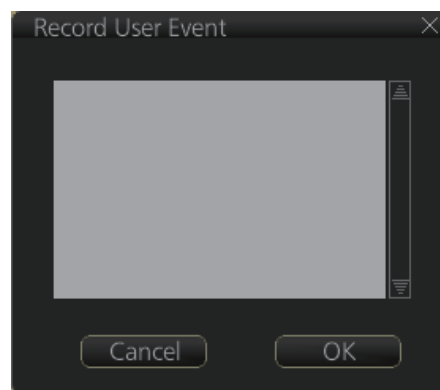

19.1.2 Position events

The operator may manually save positions to the [Event] log by position or LOP (Line of Position):

To record a position, do as follows:

1. Get into the Navigational or Voyage planning mode then click the [Log], [Event Log] and [POSN Event] buttons on the InstantAccess bar™ to show the [Position Event] dialog box.

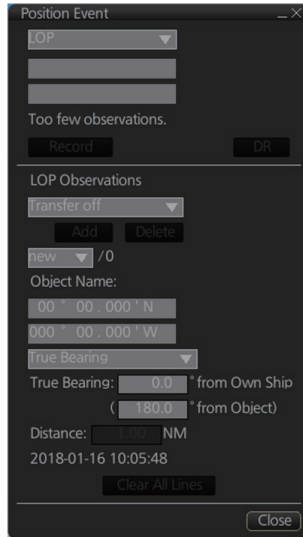

2. At the list box at the top of the dialog box, select position type.
 - [Manual]: Manual input of ship's position. Go to step 4.
 - [LOP]: Latitude and longitude position of a fixed object at ship's position. Go to step 5.
 - [Position]: Ship's position fed from navigator selected. Go to step 3.
3. For [Position], click the [Log] button.



The position event mark appears at the ship's position. The position is recorded to the [Voyage] log.

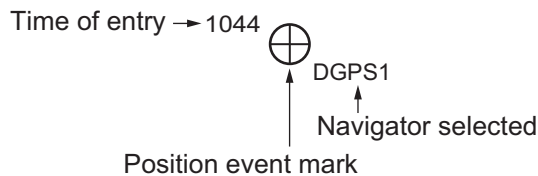

4. For [Manual], manually enter position, enter a comment if required, then click the [Log] button.

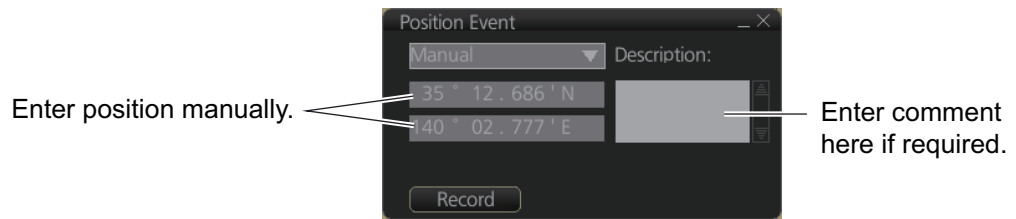

The position event mark appears at the manual input position. The position is recorded to the [Voyage] log.



5. For [LOP], see the description below.

Position fixes defined by Line of Position (LOP)

A plotted line on which a vessel is located, determined by observation or measurement of the range or bearing to an aid to navigation or other charted element. Two or more simultaneous observations can be combined to produce an estimate of the ship's current position. If the position is based on only two observations, it is an "estimated position" (EP); otherwise it is called a fix. A maximum of 6 observations can be entered to obtain a fix.

Basic operation: Coordinates of the aid to navigation can be entered into dialog boxes or they can be selected graphically on the chart. Click on a charted object (beacon, light, buoy etc.). Description of the object appears above coordinate boxes.

Default values for bearing and range are approximated from ship's current position information. The time of observation is stopped when the object is selected (or when the [Add] button is clicked). Click the [Add] box to include the observation in the fix computation. The counter shows "new/1", at the input of the second observation. The word "new" indicates that the observation currently displayed is not yet included in the fix computation, and it appears as a dashed line or ring on the chart. The added observations can be edited or deleted after selecting them at the counter. When at least two measurements are entered, the EP or fix is computed and the coordinates are shown in the top part of the dialog. To show a position symbol on the chart, click the [Log] button. In the case of an EP, the letters EP are shown on the right side of the coordinates. If a valid position estimate cannot be obtained, a message is displayed under the coordinates. This may happen, for example, if the lines / circles have multiple crossings that are far apart, or if two lines are nearly parallel or don't intersect at all. The accuracy limit (estimated standard error) is 1.0 NM. If the estimate is valid, the [Log] box can be clicked to record the current position estimate in the [Voyage] log. Discrepancy between LOP result and ship position is also recorded in the log (this information may be viewed by Info query on the position event symbol on the chart - which is displayed if position event display is on in chart display settings).

Time transfer: If the observations are not simultaneous, they should be transferred to a common time. Transferring is based on dead reckoning of ship movement. If a position line (or ring) is transferred, the letters TPL are shown beside its timestamp on the chart. The method of transfer may be selected in the bottom of the dialog. [Transfer to latest] transfers the measurements as if they were all made at the time of the newest measurement. [Continuous transfer] transfers all measurements to real time. [Transfer off] can be used to check where the measurement origins are. The position estimate and the record function follow the same logic, which means that Transfer off shows a position that has no relevance and Transfer to latest sends an old position to the [Voyage] log (timestamp in the log does not match the position).

If you are satisfied with the position shown in the latitude and longitude fields, then click the [Log] button to save the position observation to the Voyage log. If you wish you can also enter latitude and longitude values manually.

Timeouts: The observations cannot be used long after they were made because dead reckoning is inaccurate.

Click the [Log] button to put a position event at the LOP-calculated position. The position is recorded to the [Voyage] log.

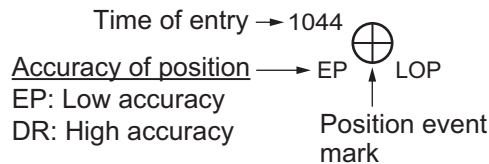

How to find position event information

You can find information about a position event by putting the cursor on the event mark then left click. The [Event Position] window shows event type (position event), time of entry, event position, name of sensor ([Position] only), comment (automatic for [LOP] and [Position]; user-entered comment* for [Manual]), and position line data ([LOP] only).

*Comment cannot be changed from this window.

Note: The [Event Information] window is shown with the [CHART for RADAR] mode.

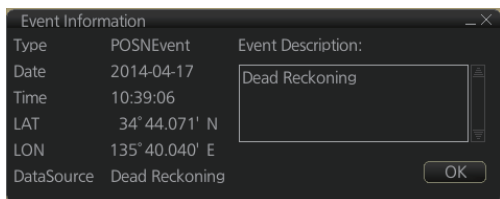

Position event: Position

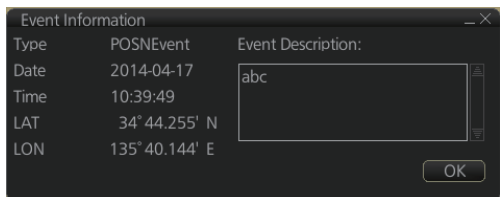

Position event: Manual

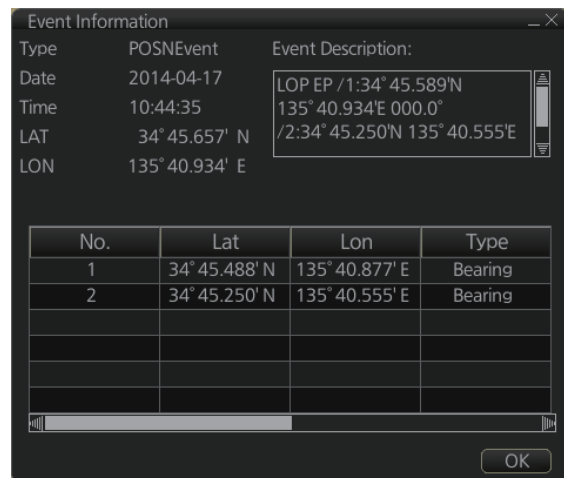

Position event: LOP

19.2 Details Log

The [Details] log contains voyage information, recorded once per minute.

- Date of entry
- Time of entry
- Source: No. of unit which generated log
- Type: Type of position data
 - Auto: Automatic input of position
- Latitude, Longitude, S.SRC: Position as output by selected sensor and sensor used as the data source.
- Align/NM, Align/°T: Range, bearing offset, if used
- SOG/kn, COG/°T, S.SRC: Speed over the ground, Course over the ground and sensor used as the data source.
- HDG/°T, S.SRC: Heading and sensor used as the data source.
- CORR/°T: Gyro correction value, if used.

How to view the Details log

Click the [Log], [NAV Log] and [Detail] buttons on the InstantAccess bar™.

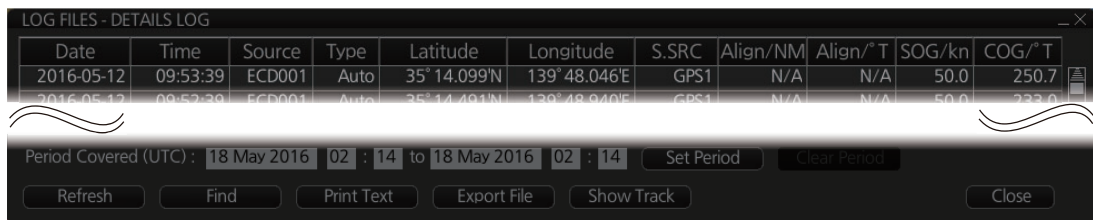

- **To show the logs of a specific period**, enter the period to show with [Period Covered (UTC)] then click the [Set Period] button. Use the [Clear Period] button to display all logs. Log entries outside the set period become gray and the entries inside the set period remain visible. To show log entries which are not visible, spin the scrollwheel upward to scroll up the log, downward to scroll down the log.
- **To refresh the log**, click the [Refresh] button.
- **To search the log**, do as follows:
 - 1) Click the [Find] button to show the [Find text] box.
 - 2) Click the input box then enter the text to search.
 - 3) Select the search direction with the up or down radio button.
 - 4) Click the [Find] button. The first matching text is highlighted in yellow at the top of the screen.
 - 5) To continue the search click the [Find] button. To cancel the search, click the [Cancel] button.
- **To print the log**, click the [Print Text] button. Select printing format then click the [Print] button. [Spread Portrait] prints two pages of data on one page.
- **To show track for the period selected**, click the [Show Track] button. Use the [Hide Track] button to erase the track.
- **To export the log**, click the [Export File] button. The file is named DetailsLogYYYYMMDDhhmmss.csv.

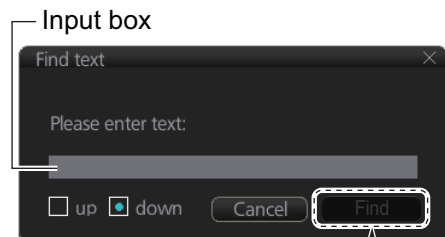

Input text in box and [Find] button appears.

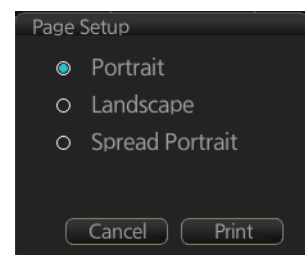

19.3 Voyage Log

The [Voyage] log records all voyage-related data of the past three months. Recorded events are:

- Date: Date of entry
- Time: Time of entry
- Type: Log entry types
 - Auto: Automatic entry of ship position, in 1 to 4 hr intervals, set by operator.
 - Ship: Logged if the amount of change in speed or course equals or is greater than the set values.
 - MOB: MOB position, entered with [MOB] button.
 - User: Operator-entered position. The information entered in the [Description] box is logged.
 - Posdev: Record user-entered position event. The [Description] window shows automatically entered data (Position, LOP) or manually entered comment (Manual). Automatically entered data (Position: data source, LOP: see below). The latitude and longitude position and bearing (or distance) of a maximum of three objects are automatically recorded to each log entry. An object whose position accuracy is low is not recorded. If an object has both a bearing and distance, separate entries are made.

L/L position, bearing of object (no.1)

LOP DR /1:35° 20.743' N 139° 44.925' E 123.4° /2:35° 20.482' N 139° 48.658' E 214.9° /3:35° 17.437' N 139° 44.820' E 3.07NM
--

- Latitude, Longitude: Position as output by selected sensor and sensor used as the data source.
- SOG/kn, COG/°T, S.SRC: Speed over the ground, course over the ground. and their source
- HDG/°T, S.SRC: Heading and its source
- CORR/°T: Offset bearing, if used
- Wind/kn Wind/°T: Wind speed and angle
- Dist/NM: Navigation distance
- Depth/m: Depth in meters
- Description: Show recorded contents, for [User], [PosDev] above.
If desired items other than [Posdev] can be edited. Click an item to show the [Edit Description] box. Edit the description as required then click the [OK] button.

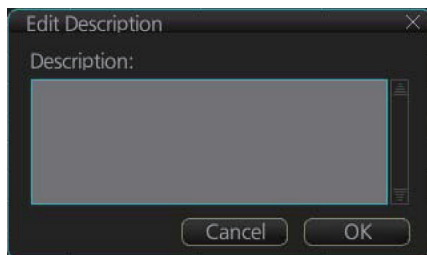

How to view the Voyage log

To open the Voyage log, click the [Log], [NAV Log] and [Voyage] buttons on the InstantAccess bar™.

Date	Time	Source	Type	Latitude	Longitude	S.SRC	SOG/kn	COG/°T	S.SRC
30.05.2013	15:38:18	ECD001	Auto	47° 30.529'N	065° 27.930'W	19.9	243.3	243.2	LOG1
30.05.2013	13:29:08	ECD002	Auto	47° 43.856'N	064° 27.605'W	20.0	260.4	260.4	LOG1

Period Covered (UTC) : 29 May 2013 19 : 38 to 29 May 2013 19 : 38

Buttons: Refresh, Find, Print Text, Export File, Show Track, Close

- **To show the logs of a specific period**, enter the period to show with [Period Covered (UTC)] then click the [Set Period] button. Use the [Clear Period] button to display all logs. Log entries outside the set period become gray and the entries inside the set period remain visible. To show log entries which are not visible, spin the scrollwheel upward to scroll up the log, downward to scroll down the log.
- **To refresh the log**, click the [Refresh] button.
- **To search the log**, do as follows:
 - 1) Click the [Find] button to show the [Find text] box.
 - 2) Click the input box then enter the text to search.
 - 3) Select the search direction with the up or down radio button.
 - 4) Click the [Find] button. The first matching text is highlighted in yellow at the top of the screen.
 - 5) To continue the search click the [Find] button. To cancel the search, click the [Cancel] button.
- **To print the log**, click the [Print Text] button. Select printing format then click the [Print] button. [Spread Portrait] prints two pages of data on one page.
- **To show track for the period selected**, click the [Show Track] button. Use the [Hide Track] button to erase the track.
- **To export the log**, click the [Export File] button. The file is named VoyageLogYYYYMMDDhhmmss.csv.

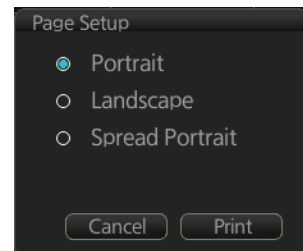

19.3.1 How to set conditions of logging

The operator can set the conditions for automatic voyage logging (logging interval only). When the following conditions are met, data is stored into the Voyage log.

- Speed (or course) change is equal to the set value.
- The logging interval time has elapsed.

To set the conditions of logging, do as follows:

1. Open the menu and select [Log], [NAV Log] and [Voyage] to show the [NAV Log] dialog box.
2. Set desired limit for log interval. Setting range: 1 to 4 hr, 1 hr interval

When your speed or course changes by the amount set here, an entry is made in the [Voyage] log, at the interval selected.

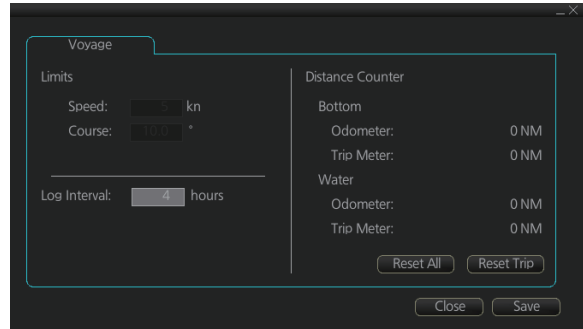

19.4 Chart Usage Log

The [Chart Usage] log stores which charts were used in chart alerts. To open the log, click [Log], [NAV Log] and [Chart Usage] on the InstantAccess bar™. The following information is recorded in the chart usage log:

- Date and time chart was displayed
- Chart ID
- Center position of display (Lat, Lon)
- Chart source
- Chart edition
- Display scale
- Compilation scale
- The latest update included to chart
- Chart base

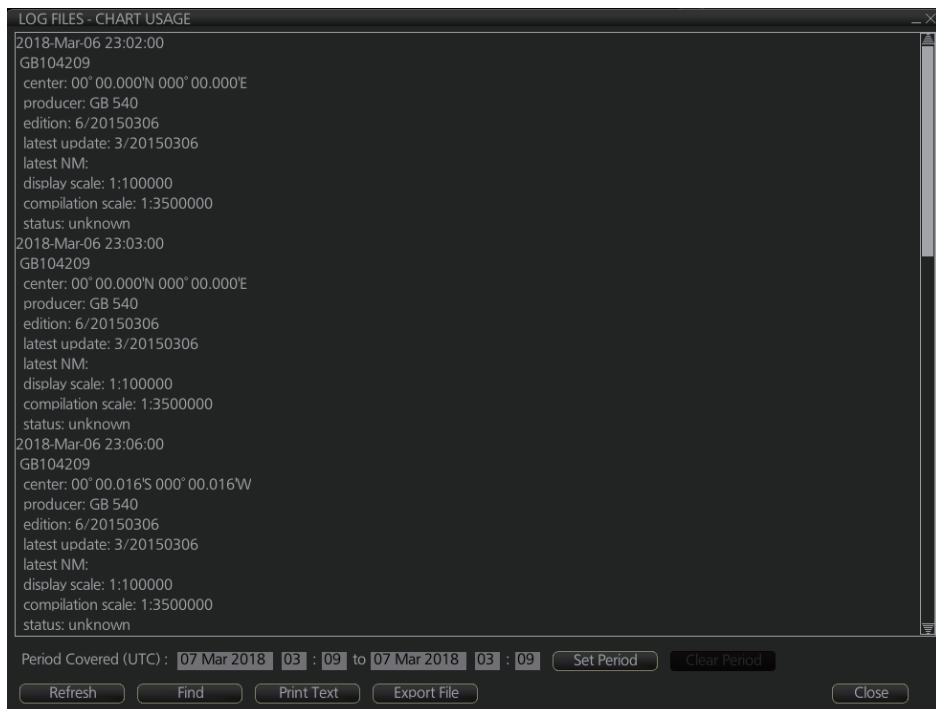

- **To show the logs of a specific period**, enter the period to show with [Period Covered (UTC)] then click the [Set Period] button. Use the [Clear Period] button to display all logs. Log entries outside the set period become gray and the entries inside the set period remain visible. To show log entries which are not visible, spin the scrollwheel upward to scroll up the log, downward to scroll down the log.
- **To refresh the log**, click the [Refresh] button.
- **To search the log**, do as follows:
 - 1) Click the [Find] button to show the [Find text] box.
 - 2) Click the input box then enter the text to search.
 - 3) Select the search direction with the up or down radio button.
 - 4) Click the [Find] button. The first matching text is highlighted in yellow at the top of the screen.
 - 5) To continue the search click the [Find] button. To cancel the search, click the [Cancel] button.
- **To export the log**, click the [Export File] button. The file is named ChartUsageLogYYYYMMDDhhmmss.txt.
- **To print the log**, click the [Print Text] button.

19.5 Danger Targets Log

The [Danger Targets] log stores information about dangerous targets that are received from a radar (TTs) and/or targets that are received from an AIS transponder (AIS targets).

If a TT or AIS target is within the set CPA (Closest Point of Approach) and TCPA (Time to CPA), information of all TTs (including non-dangerous targets) are recorded into the danger target log. This data is as follows:

- Date: Date of entry
- Time: Time of entry
- Source: Unit which generated log
- Type: Type of dangerous target
- Target ID: When [Type] is [TT] - Dangerous target's number.
When [Type] is [AIS] - MMSI number
- Latitude and Longitude: Latitude and longitude position of dangerous target
- SPD/kn: Speed of dangerous target
- CRS/°T: Course of dangerous target
- HDG/°T: Heading of dangerous target
- CPA/NM, TCPA/min: CPA and TCPA of dangerous target

How to view the danger targets log

To open the [Danger Targets] log, click the [Log], [Target Log] and [Danger Target] buttons on the InstantAccess bar™.

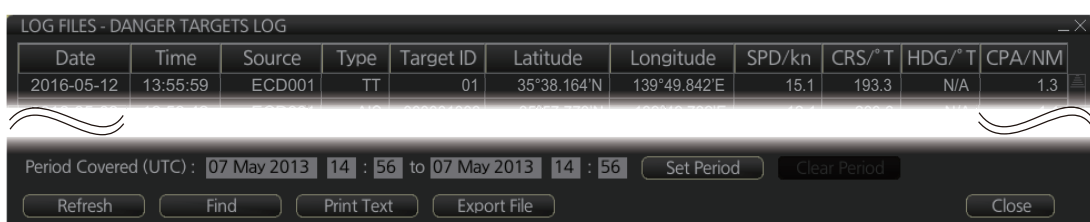

The screenshot shows a window titled "LOG FILES - DANGER TARGETS LOG" with a table of log entries and a control panel below it.

Date	Time	Source	Type	Target ID	Latitude	Longitude	SPD/kn	CRS/°T	HDG/°T	CPA/NM
2016-05-12	13:55:59	ECD001	TT	01	35°38.164'N	139°49.842'E	15.1	193.3	N/A	1.3

Below the table, the control panel includes:

- Period Covered (UTC): 07 May 2013 14 : 56 to 07 May 2013 14 : 56
- Buttons: Set Period, Clear Period, Refresh, Find, Print Text, Export File, Close

- **To show the logs of a specific period**, enter the period to show with [Period Covered (UTC)] then click the [Set Period] button. Use the [Clear Period] button to display all logs. Log entries outside the set period become gray and the entries inside the set period remain visible. To show log entries which are not visible, spin the scrollwheel upward to scroll up the log, downward to scroll down the log.
- **To refresh the log**, click the [Refresh] button.
- **To search the log**, do as follows:
 - 1) Click the [Find] button to show the [Find text] box.
 - 2) Click the input box then enter the text to search.
 - 3) Select the search direction, with the up or down radio button.
 - 4) Click the [Find] button. Matching text is highlighted in yellow at the top of the screen.
 - 5) To continue the search click the [Find] button. To cancel the search, click the [Cancel] button.
- **To print the log**, click the [Print Text] button. Select printing format then click the [Print] button.
- **To export the log**, click the [Export File] button. The file is named DangerTargetLogYYYYMMDDhhmmss.csv.

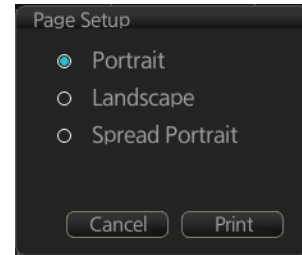

19.5.1 How to filter the danger targets log

You can filter the danger targets log by CPA or TCPA. When a TT or AIS target's CPA or TCPA is lower than the setting here, the target's details are automatically logged.

To set the filter, do the following:

1. Open the menu and select [Log], [Target Log] and [Danger Target] to show the [Danger Targets] menu.

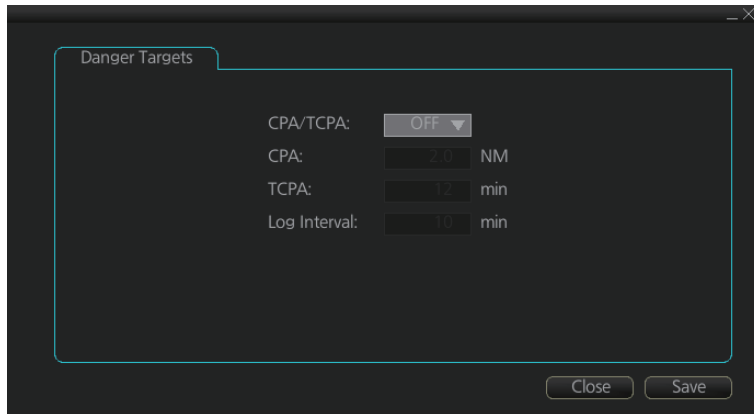

2. At [CPA/TCPA], select [ON].
3. At [CPA], set the distance for the CPA.
4. At [TCPA], set the time for the TCPA.
- Note:** [Log Interval] is fixed at 10 minutes.
5. Click [Save] to save the settings, then click [Close] to close the menu.

19.6 Route Transfer Log

The [Route Transfer] log keeps a tab of sent and received route-related communications. When one or more of the following conditions are met, an entry is made in the [Route Transfer] log.

- RRT sentence is sent from this system.
- RRT sentence is received by this system.
- A sent RRT sentence is not acknowledged by an external device.

The log data includes the following:

- Date: Date of entry
- Time: Time of entry
- Communication Type: Send, Receive or No Response
- Source: UID of route related communication
- Destination: UID of destination of route related communication
- Detail: Content of transfer
- Transfer Type: Type of communication - Monitor route, Plan route, or Query
- Transfer Name: Name of transferred route
- Transfer Version: Transferred route's version
- Current WPT: Current waypoint
- Transfer Status: Current transfer status of the transferred route
- Application Status: Current status of the transfer application

How to view the route transfer log

On the InstantAccess bar, click the [Log], [Target Log] and [Route TRANS Log] buttons

Date	Time	Communication Type	Source	Destination	Detail	Transfer Type
2007-06-02	21:26:56	Send	EI0002	*****	Information request.	Query
2007-06-02	15:39:47	Receive	EI0001	EI0002	Success.	Plan route

Period Covered (UTC) : 05 Apr 2016 00 : 43 to 05 Apr 2016 00 : 43

Buttons: Refresh, Find, Print Text, Export File, Close

- **To show the logs of a specific period**, enter the period to show with [Period Covered (UTC)] then click the [Set Period] button. Use the [Clear Period] button to display all logs. Log entries outside the set period become gray and the entries inside the set period remain visible. To show log entries which are not visible, spin upward to scroll up the log, downward to scroll down the log.
- **To refresh the log**, click the [Refresh] button.
- **To search the log**, do as follows:
 - 1) Click the [Find] button to show the [Find text] box.
 - 2) Click the input box then enter the text to search.
 - 3) Select the search direction with the up or down radio button.

19. RECORDING FUNCTIONS

- 4) Click the [Find] button. Matching text is highlighted in yellow at the top of the screen.
 - 5) To continue the search click the [Find] button. To cancel the search, click the [Cancel] button.
- **To print the log**, click the [Print Text] button. Select the printing format then click the [Print] button.
 - **To export the log**, click the [Export File] button. The file is namedRouteTransferLogYYYYMMDDhhmmss.csv.

20. ALERTS

20.1 What is an Alert?

“Alert” is a generic name for a notice to any unusual or potentially dangerous situation generated within the system.

Alerts are classified according to priority and category.

Alert priority

There are four alert priorities: emergency*, alarm, warning and caution.

* Generated when this radar is connected to an AMS.

Emergency: Immediate danger to human life or to the ship and its machinery exists and that immediate action must be taken. **Emergency alerts are handled the same as an alarm.**

Alarm: Situations or conditions which require immediate attention, decision and (if necessary) action by the bridge team to avoid any kind of hazardous situation and to maintain the safe navigation of the ship.

Warning: Conditions or situations which require immediate attention for precautionary reasons, to make the bridge team aware of conditions which are not immediately hazardous, but may become so.

Caution: Awareness of a condition which continues to require attention out of the ordinary consideration of the situation or of given information.

Alert category

An alert is further classified by category, A, B or C, according to its degree of severity or source.

Category	Description
A	Category A alerts include alerts indicating <ul style="list-style-type: none">• Danger of collision• Danger of grounding
B	Category B alerts are alerts where no additional information for decision support is necessary. Category B alerts are all alerts not falling under category A.
C	Engine-related alert

20.2 Alert Box

When an alert is generated, the related alert message and alert state icon appear in the [Alert] box, which is at the bottom right corner on the screen. An audible alarm is additionally generated for alarms and warnings.

In addition to the alert message and alert state icon, the [Alert] box has the buzzer stop button and provides access to the [Alert List] and [Alert Log].

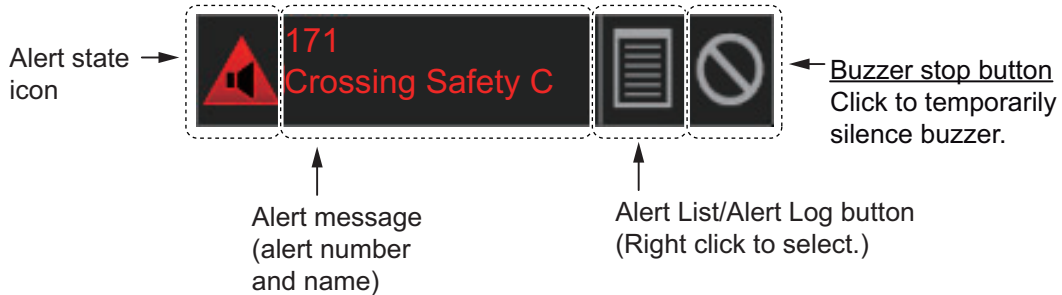

Alert state icon: The state of an alert is shown with an icon. See page 20-4.







Alert message: The number and name of all active alerts appear in the message area, with the alert of the highest priority on top always. The color of both the message and the background change according to alert priority and alert state. See the table on the next page.

An alert can be acknowledged from the [Alert] box or [Alert List]. An alert remains in the [Alert] box and [Alert List] until it is acknowledged and rectified. See section 20.5.

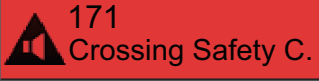
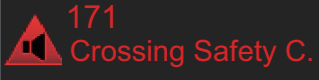
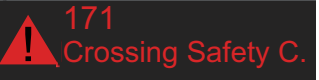
Alert List/Alert Log button: Right-click to select [Alert List Window] or [Alert Log Window]. The background color of the button is light blue when the list or log is open. See section 20.5 and section 20.6 for a description of the list and log respectively.











Buzzer stop button: Click to temporarily silence the buzzer, which sounds against alarms and warnings. See page 20-5.

Alert message display format

Alert indication	Priority of alert	Alert state	Display state
 <p>171 Crossing Safety C.</p> <p>Displayed alternately</p> 	Emergency, Alarm	- Not acknowledged/ Not rectified. OR - Not acknowledged/ Rectified.	Black characters on red background. (Flashing) Red characters on gray background.
	Emergency, Alarm	Acknowledged/Not rectified.	Red characters on gray background.
 <p>10173 Crossing Special Area</p> <p>Displayed alternately</p> 	Warning	- Not acknowledged/ Not rectified. OR Not acknowledged/ Rectified.	Black characters on yellow-orange background. (Flashing) Yellow-orange characters on gray background.
	Warning	Acknowledged/Not rectified.	Yellow-orange characters on gray background.
	Caution	Not rectified.	Yellow characters on gray background.
	Emergency, Alarm, Warning	Acknowledged/Rectified.	No display.
	Caution	Rectified.	No display.



Alert state icons

The table shows the icons used to indicate the various alert states for the alarm, warning and caution alerts.

Icon		Alert state	Icon description
Alert priority: Alarm			
1		Not acknowledged/Not rectified	Red triangle with black loudspeaker in center of triangle. Flashing (on 1 s, off 1 s).
2		Not acknowledged/Not rectified, Buzzer temporarily silenced	Red triangle with crossed out black loudspeaker in center of triangle. Flashing (on 1 s, off 1 s).
3		Acknowledged/Not rectified	Steadily displayed red triangle with black exclamation point in center of triangle.
4		Active - responsibility transferred alarm	Steadily displayed red triangle. Right arrow at center. Presented together with alert text.
5		Not acknowledged/Rectified	Red triangle with black check mark in center of triangle. Flashing (on 1 s, off 1 s).
Alert priority: Warning			
6		Not acknowledged/Not rectified	Yellow-orange circle with black loudspeaker in center of circle. Flashing (on 1 s, off 1 s).
7		Not acknowledged/Not rectified, Buzzer temporarily silenced	Yellow-orange circle with crossed out black loudspeaker in center of circle. Flashing (on 1 s, off 1 s).
8		Acknowledged/Not rectified	Steadily displayed yellow-orange circle with black exclamation point in center of circle.
9		Active - responsibility transferred warning	Steadily displayed yellow-orange circle. Right arrow at center. Presented together with alert text.
10		Not acknowledged/Rectified	Yellow-orange circle with black check mark in center of circle. Flashing (on 1 s, off 1 s).
Alert priority: Caution			
11		Caution	Steadily displayed yellow square with black exclamation point in center of square.

Buzzer stop button

The color of both the background and the icon change according to alert state.

Button state	Description
	No alert generated. The background is gray and the icon is grayed out.
	An alarm or warning is being acknowledged. The background is gray and the icon is white.
	Button clicked to silence buzzer temporarily. The background is light-blue and the icon is black.

20.3 How to Temporarily Silence the Buzzer for an Emergency, Alarm or Warning

When the buzzer for an emergency, alarm or warning sounds, you can temporarily silence it by doing one of the following:

- Click the buzzer stop button in the [Alert] box.
- In the [Alert List], click the [Silence] button.

The buzzer is stopped and the alert state changes. An alert message remains in the [Alert] box and [Alert List] until acknowledged and rectified.

20.4 How to Acknowledge an Emergency, Alarm or Warning

When an alarm or warning is generated, the buzzer sounds and the name of the alert appears and flashes in the [Alert] box and [Alert List].

To acknowledge the alert, do one of the following:

- Press the **ALARM ACK** key.
- In the [Alert] box, click the unacknowledged alert.
- In the [Alert List], click either the alert name or the [ACK] button.

After acknowledgement, the buzzer and the flashing for the alert message are stopped and the priority of the alert changes as shown in the table below. The alert message remains on the display until rectified.

Priority no.	Priority of alert	Alert state
High	1	Emergency, Alarm
	2	Warning
↑ ↓	3	Emergency, Alarm
	4	Warning
	5	Emergency, Alarm
	6	Warning
	7	Caution
Low		

Category of alert and place of alert acknowledgement

The place of alert acknowledgement depends on the category of the alert.

Category	Where alert notification occurs	Place of alert acknowledgement
A	Equipment that generated the alert and AMS* (Alert Management System).	Equipment that generated the alert.
B	Equipment that generated the alert and AMS	Equipment that generated the alert or AMS.
C	IAS (Integrated Automation System) generated engine alert.	—

* A category A alert does not sound at the AMS.

20.5 Alert List

The [Alert List] displays all active alerts, with unacknowledged alerts at the top, in priority order. The ZDA sentence is required to display the time in the list.

Note 1: The [Alert List] cannot be opened while the radar is transmitting.

Note 2: A full list of alerts, along with their meaning and action required (if any) is supplied at the back of this manual.

The log shows the following information for each alert:

- Alert no.
 - Alert text
 - Source of alert
 - Time (UTC) alert was generated
 - Time (UTC) alert was acknowledged
 - Details about the alert selected
 - Quantity of unacknowledge alerts*
- *: Chart mode only.

Alert list in radar mode

To show the alert list in radar mode, right-click the [Alert List/Alert Log] button in the Alert box, click [Alert List/Alert Log] then click the [Alert List] tab.

ACK ALL button Silence buzzer button

Decision Support (Right Click on Each Alert) :

ACK Silence Alert details

1 / 1 UnACK : 0

Status	AlertNo	Instance	Description	Source	Occur	ACK
!	10380	131	AIS COM Error	No.1 Chart R	23:07 11 Apr 20.	23:31 11 Apr 20.
!	170	-	Positioning System Fail.	No.1 Chart R	23:07 11 Apr 20.	23:31 11 Apr 20.
!	10002	14	Processor Unit Fan1 F.	No.1 Chart R	23:07 11 Apr 20.	23:46 11 Apr 20.
!	10002	15	Processor Unit Fan2 F.	No.1 Chart R	23:07 11 Apr 20.	23:46 11 Apr 20.
!	10601	5	Heading Sensor Not A.	No.1 Chart R	23:07 11 Apr 20.	23:46 11 Apr 20.
!	194	9	SPU Error	No.1 Chart R	23:07 11 Apr 20.	23:32 11 Apr 20.
!	194	14	MTR-DRV COM Error	No.1 Chart R	23:07 11 Apr 20.	23:31 11 Apr 20.
!	10601	5	UTC Time Not Available	No.1 Chart R	23:07 11 Apr 20.	23:31 11 Apr 20.
!	10601	5	COG/SOG Not Availa.	No.1 Chart R	23:07 11 Apr 20.	23:31 11 Apr 20.
!	10601	6	SOG Not Available	No.1 Chart R	23:07 11 Apr 20.	23:31 11 Apr 20.
!	10601	6	SDME Sensor Not Avail	No.1 Chart R	23:07 11 Apr 20.	23:31 11 Apr 20.
!	194	18	PSU-Control COM Error	No.1 Chart R	23:07 11 Apr 20.	23:31 11 Apr 20.
!	10001	16	Sub Monitor COM Ti.	No.1 Chart R	23:09 11 Apr 20.	-

Alert state icon/Aggregate icon

Alert no/ Instance Alert name Alert source Time of alert Time of acknowledgement

Page selection buttons
Click to select page.
Available only when multiple pages exist.
▶ : Show next page
▶| : Jump to last page
◀ : Show previous page
|◀ : Jump to first page

No. of unacknowledged alerts
If there are no unacknowledged alerts, "0" is shown.

The background color of an unacknowledged alarm is red and flashing and unacknowledged warning is yellow-orange and flashing. An acknowledged alert is displayed steadily, in red for alarm and yellow-orange for warning. A caution is displayed steadily in yellow.

The [Filter] checkboxes at the top of the window let you select what alerts to view. Check or uncheck the boxes to show or hide the corresponding alerts.

To find details about an alert, click the applicable alert icon, the alert details appear in the [Detail] box at the top of the window. The box shows the reason for the alert, how to handle the alert, etc.

An individual alarm or warning can be acknowledged by clicking it.

The [Silence] button silences the buzzer.

Alert list in chart mode

To show the alert list in radar mode, right-click the [Alert List/Alert Log] button in the Alert box, click [Alert List].

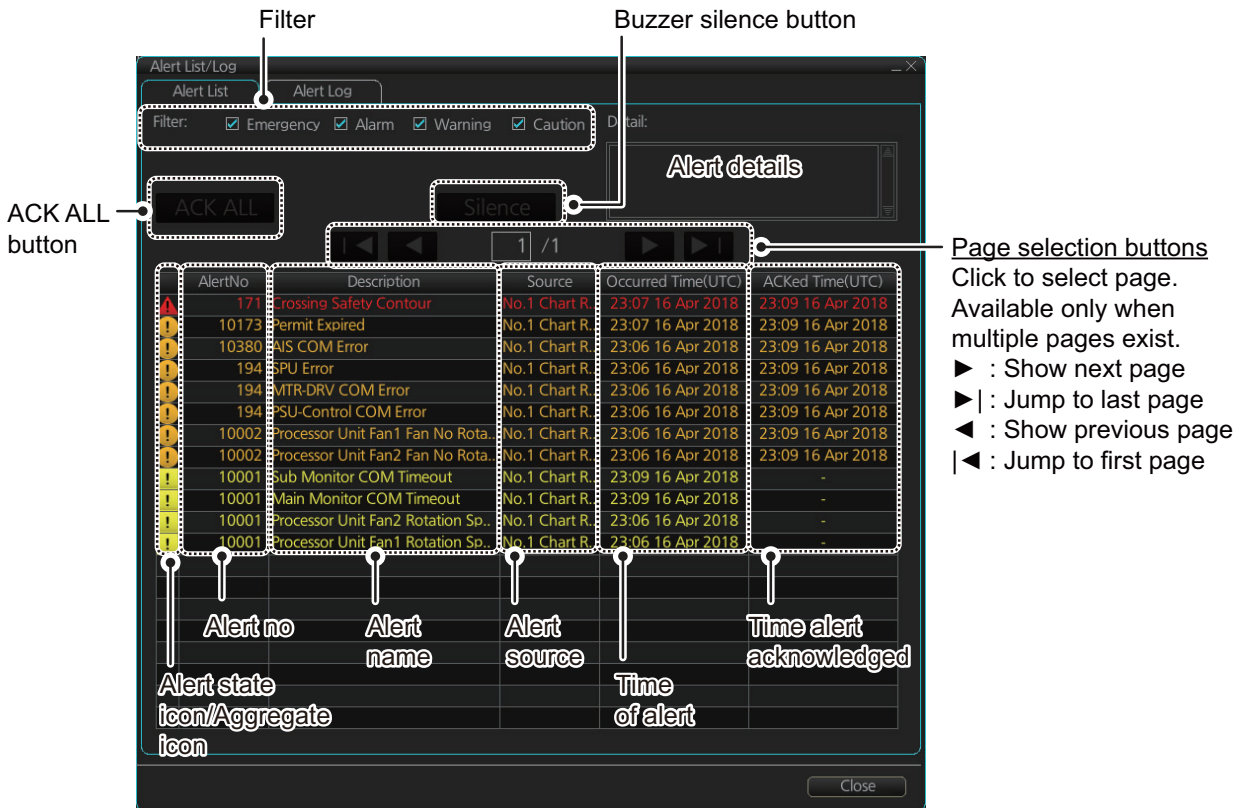

The background color of an unacknowledged alarm is red and flashing and unacknowledged warning is yellow-orange and flashing. An acknowledged alert is displayed steadily, in red for alarm and yellow-orange for warning. A caution is displayed steadily in yellow.

The Status section has three columns. Icons appear in the columns as follows:

- Left column: Emergency, Alarm, Warning and Caution icons (numbers 1 to 11 in the table at "Alert state icons" on page 20-4).
- Middle column: Blank.
- Right column: Blank.

The [Filter] checkboxes at the top of the window let you select what alerts to view. Check or uncheck the boxes to show or hide the corresponding alerts.

To find details about an alert, click the applicable alert, the alert details appear in the [Detail] box at the top of the window. The box shows the reason for the alert, how to handle the alert, etc.

An individual alarm or warning can be acknowledged by clicking it.

The [Silence] button silences the buzzer.

How the alert list is updated after acknowledgement, rectification

When you acknowledge an alert, its display method on the [Alert] list changes according to alert category and alert state. Acknowledged and rectified alerts are immediately removed from the list.

No.	Alert priority	Alert state	Display after acknowledgement	Display after rectification
1	Emergency, Alarm	Not acknowledged/Not rectified	5	2
2		Not acknowledged/Rectified	8	–
3	Warning	Not acknowledged/Not rectified	6	4
4		Not acknowledged/Rectified	9	–
5	Emergency, Alarm	Acknowledged/Not rectified	–	8
6	Warning	Acknowledged/Not rectified	–	9
7	Caution	Not rectified	–	10
8	Emergency, Alarm	Acknowledged/Rectified	–	–
9	Warning	Acknowledged/Rectified	–	–
10	Caution	Rectified	–	–

20.6 Alert Log

The [Alert] log stores and displays the latest 10,000 alerts.

Note: The [Alert Log] cannot be opened while the radar is transmitting.

The log shows the following information for each alert:

- Priority of alert (Emergency, Alarm, Warning, Caution)
 - Category of alert (A, B or C)
 - Alert no., alert instance*¹
 - Alert name
 - Source of alert
 - Time (UTC) alert occurred
 - Time (UTC) alert was acknowledged
 - Time (UTC) alert was rectified
 - Time (UTC) alert was silenced*¹
 - Time (UTC) alert was transferred to AMS*¹
 - Details for selected alert*²
- *¹: Chart for Radar mode only
 *²: Radar mode or Chart for Radar mode only

Alert log in radar mode

To show the alert log in radar mode, right-click the [Alert List/Alert Log] button in the Alert box, click [Alert List/Alert Log] then click the [Alert Log] tab.

The screenshot shows the 'Alert List/Log' window. At the top, there are 'Priority Filter' and 'Category Filter' sections with checkboxes for Emergency, Alarm, Warning, and Caution. Below these are 'Page selection buttons' for navigating between pages (1/23). The main area is a table with columns: Priority, Cat., AlertNo., Description, Source, and Occurred Time(UTC). A dashed box highlights the table, with a label 'Time alert occurred' pointing to a specific row. Below the table is a 'Details' section with fields for 'Priority', 'Alert name', 'Alert no.', and 'Alert-source', and buttons for 'Reset', 'Find', 'Export Log', and 'Close'. A label 'Scroll right to show:' points to the right side of the details section, with a list of items: 'Time alert was acknowledged' and 'Time alert cause was rectified'.

You can select what type of alerts to display with [Priority Filter] and [Category Filter] at the top of the list. The list can be sorted by [Priority], [Cat.], [Alert No.], [Description], [Source], [Occurred Time], [ACKed Time] or [Rectified Time]. Click the corresponding column title to sort. To find detailed information about an alert, select it to show detailed information in the [Detail] box. To search the log, enter text in the [Log Search] box then click the [Find] button. You can save the contents of the log to a USB flash memory, in “.dat” format, by clicking the [Export Log] button.

Alert log in chart mode

To show the alert list in radar mode, right-click the [Alert List/Alert Log] button in the Alert box, click [Alert List].

Priority filter **Category filter**

Alert List/Log

Alert List Alert Log

Priority Filter: Emergency Alarm Warning Caution Category Filter: A B C

1 / 25

Priority	Cat.	AlertNo.	Description	Source	Occurred time(UTC)
Caution	B	1000	Sub Monitor COM Timeout	No.1 Chart R.	23:09 16 Apr 2018
Caution	B	1000	Main Monitor COM Timeout	No.1 Chart R.	23:09 16 Apr 2018
Warning	A	1017	Permit Expired	No.1 Chart R.	23:07 16 Apr 2018
Warning	A	1017	UKC Limit	No.1 Chart R.	23:07 16 Apr 2018
Warning	A	17	Marine Farm / Aquaculture	No.1 Chart R.	23:07 16 Apr 2018
Alarm	A	17	Crossing Safety Contour	No.1 Chart R.	23:07 16 Apr 2018
Caution	B	1040	SDME 1 COM Error	No.1 Chart R.	23:06 16 Apr 2018
Caution	B	1040	Gyro 1 COM Error	No.1 Chart R.	23:06 16 Apr 2018
Warning	B	17	Positioning System Failure	No.1 Chart R.	23:06 16 Apr 2018
Caution	B	1040	EPFS 1 COM Error	No.1 Chart R.	23:06 16 Apr 2018
Warning	B	1038	AIS COM Error	No.1 Chart R.	23:06 16 Apr 2018
Warning	B	19	PSU-Control COM Error	No.1 Chart R.	23:06 16 Apr 2018
Warning	B	1060	SDME Sensor Not Available	No.1 Chart R.	23:06 16 Apr 2018
Warning	B	1060	SOG Not Available	No.1 Chart R.	23:06 16 Apr 2018
Warning	B	1060	COG/SOG Not Available	No.1 Chart R.	23:06 16 Apr 2018
Caution	B	1060	STW Not Available	No.1 Chart R.	23:06 16 Apr 2018
Warning	B	1060	UTC Time Not Available	No.1 Chart R.	23:06 16 Apr 2018
Warning	B	1060	Heading Sensor Not Available	No.1 Chart R.	23:06 16 Apr 2018
Warning	B	19	MTR-DRV COM Error	No.1 Chart R.	23:06 16 Apr 2018

Page selection buttons
Click to select page.
Available only when multiple pages exist.
▶ : Show next page
▶| : Jump to last page
◀ : Show previous page
|◀ : Jump to first page

Time alert occurred

Scroll right to show:
• Time alert was acknowledged
• Time alert cause was rectified

Priority **Alert name** **Alert-source**

Alert no. **Category** **Details**

Log Search: Reset Find Export Log Close

You can select what type of alerts to display with [Priority Filter] and [Category Filter] at the top of the list. The list can be sorted by [Priority], [Cat.], [Alert No.], [Description], [Source], [Occurred Time], [ACKed Time] or [Rectified Time]. Click the corresponding column title to sort. To find detailed information about an alert, select it to show detailed information in the [Detail] box. To search the log, enter text in the [Log Search] box then click the [Find] button. You can save the contents of the log to a USB flash memory, in “.dat” format, by clicking the [Export Log] button.

20.7 Alert Reception from Connected Sensors

An “ALR receive and ACK transmit” communication is available for every serial line input. The ALR message from the sensor includes information about alerts from the sensor, and is presented through the normal alert system. When you acknowledge an alert, an ACK message is sent to the sensor to do remote acknowledge.

This interface is based on IEC 61162-1 and IEC 80/520/INF.

This page is intentionally left blank.

21. PARAMETERS

21.1 Ship and Route Parameters

The purpose of the ship and route parameters is set the basic parameters for the ship. These parameters are relative to ship steering and they are very important to get correct function of the integrated navigation system. They must be maintained carefully. Modification requires a good knowledge of the parameters' importance.

Open the menu and select [Ship & Route Parameters] from the [General] menu to show the [Ship & Route] page. Set each item referring to the description below.

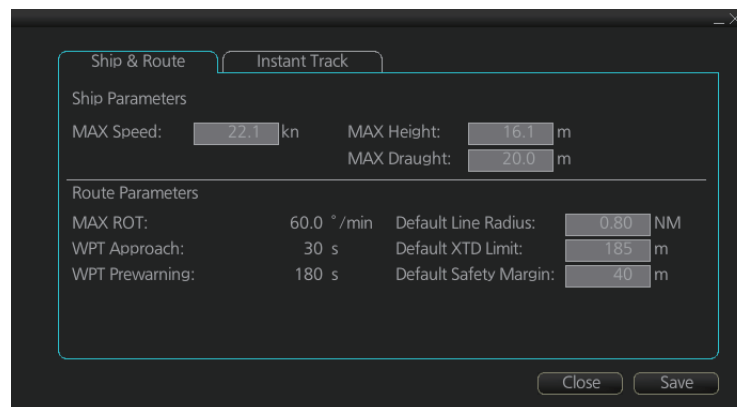

Ship parameters description

[MAX Speed]: Maximum speed the ship can do.

[MAX Height]: Max. height of ship above sea level.

[MAX Draught]: Max. draught of ship.

Route parameters description

[MAX R.O.T]*: The maximum rate of turn of the ship. Set at installation.

[WPT Approach]*: The alert time before reaching the wheel over point.

[WPT Prewarning]*: The alert time before reaching the wheel over point.

[Default Line Radius]: Define the default value of radius between waypoints during automatic route steering.

[Default XTD Limit]: Define the default value of XTD limit.

[Default Safety Margin]: Define the default value of extension for channel limits to be checked against selected alerts.

* Set at installation and cannot be changed by the operator.

21.2 Forwarding Distances

The forwarding distances are the distances the ship travels straight after the steering command is given to the autopilot. These distances change according to the radius of turn.

The forwarding distances are entered at installation and cannot be changed by the operator. However, the operator can view the forwarding distances settings on the [Forwarding Distance] display ([MENU]→[General]→[Navigation Parameter]).

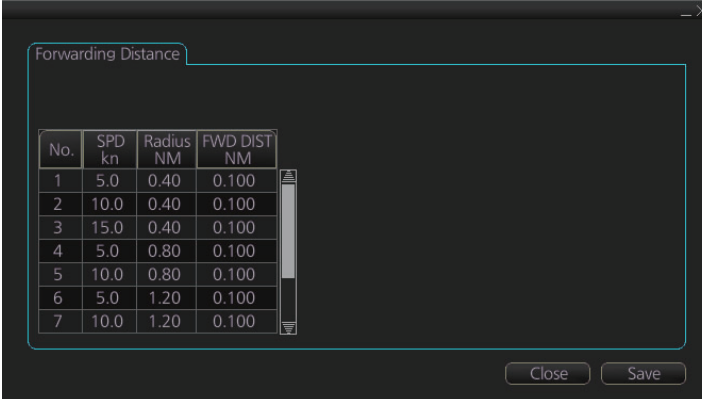

The screenshot shows a window titled "Forwarding Distance" with a table of settings. The table has four columns: "No.", "SPD kn", "Radius NM", and "FWD DIST NM". There are seven rows of data. Below the table are "Close" and "Save" buttons.

No.	SPD kn	Radius NM	FWD DIST NM
1	5.0	0.40	0.100
2	10.0	0.40	0.100
3	15.0	0.40	0.100
4	5.0	0.80	0.100
5	10.0	0.80	0.100
6	5.0	1.20	0.100
7	10.0	1.20	0.100

Note: These are the port side values. Starboard side values can also be shown. Contact a FURUNO dealer for details.

21.3 Cost Parameters

The cost parameters are used in the optimization calculation. Therefore define these parameters before doing the calculation.

Open the menu and select [Cost Parameters] from the [General] menu to show the [Cost Parameters] page. Set each item according to ship's plan, etc.

Speed kn	Heavy Fuel Oil ton/hr	Diesel Oil ton/hr
0.0	0.000	0.000
0.0	0.000	0.000
0.0	0.000	0.000
0.0	0.000	0.000
0.0	0.000	0.000
0.0	0.000	0.000
0.0	0.000	0.000
0.0	0.000	0.000
0.0	0.000	0.000
0.0	0.000	0.000
0.0	0.000	0.000
0.0	0.000	0.000

At the [Cost] window, enter the cost/hour and cost/ton for heavy fuel oil and diesel oil. At the [Fuel Consumption] window, define the fuel consumption figures for up to 12 different speeds. Before entering the data, plot the data on a graph, like the one shown below. Use a second graph if, for example, diesel oil consumption is different from that of heavy fuel oil. Reset the power to effect the settings.

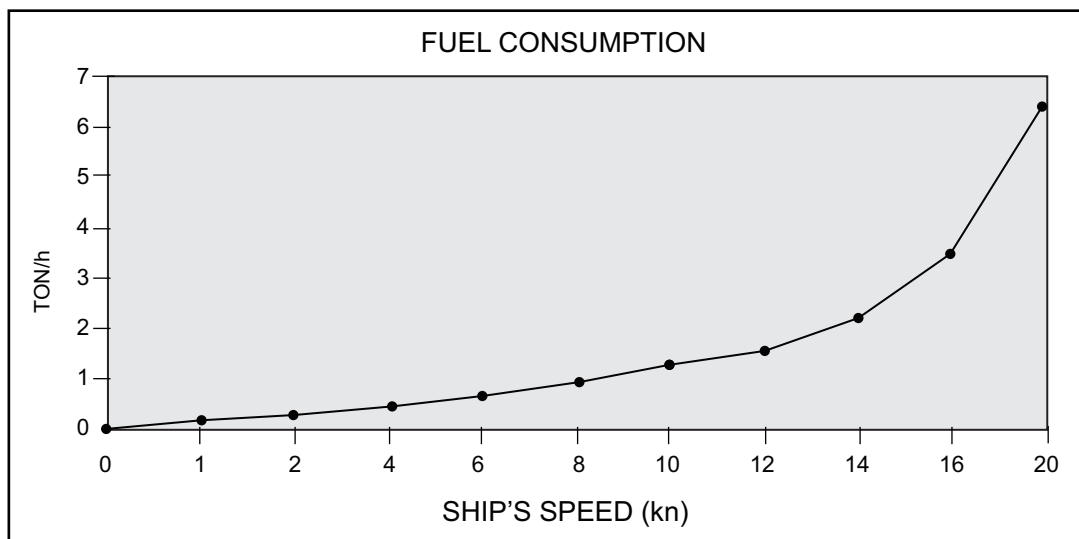

21.4 Instant Track Parameters

The instant track feature can create, in route monitoring, a simple route in the following situations:

- Return to the monitored route when the vessel goes outside the channel limits.
- Temporarily deviate from the monitored route (avoid collision, etc.).

How to set instant track parameters

Set the parameters for the instant track ([MENU] → [General] → [Ship & Route Parameters] → [Instant Track] tab).

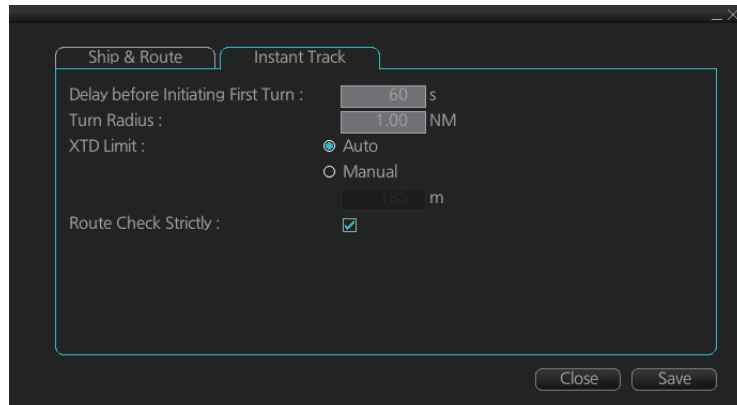

[Delay before Initiating First Turn]: Set the number of seconds (30 - 600 seconds) to wait before initiating the first turn in the simple route.

[Turn Radius]: Set the turning radius (0.02 - 3.00 NM) to use between waypoints (four waypoints) in the simple route.

[XTD Limit]: Set the channel limit (10 - 3704 m) for the instant track, automatically or manually. The [Auto] setting uses the channel limit set for the monitored route.

[Route Check Strictly]: Check to prevent monitoring of instant track when a chart alert (alarm or warning) is found through the route check. Uncheck to monitor instant track in spite of chart alert found through the route check.

22. SETTINGS MENU

The [Settings] menu provides file import, export and maintenance, testing facilities (display, keyboard, self test), data sharing, customizing, screenshot processing, and CCRP selection.

Note: The [Alert Settings] page has no use.

22.1 How to Access the Settings Menu

Click the Settings button () on the Status bar then select [Settings]. The right message appears.

Click the [OK] button to show the [Settings] menu.

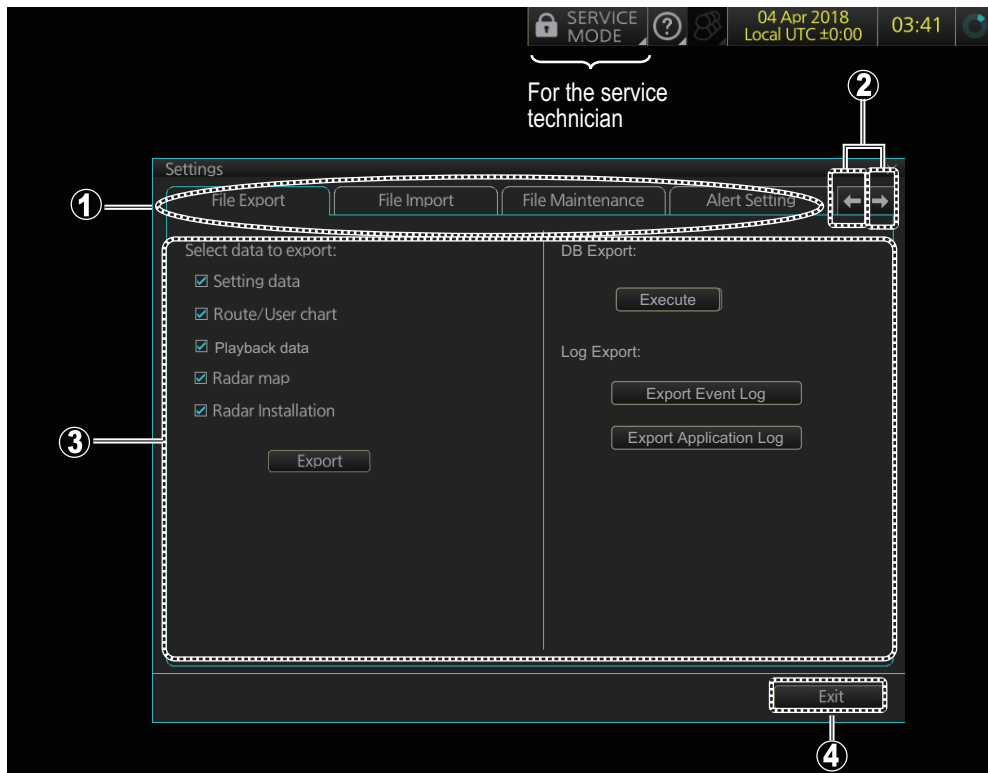
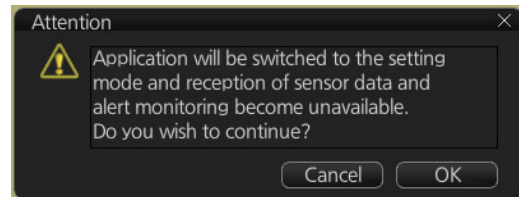

No.	Name	Description
1	Pages (menus)	Twelve menus.
2	Page selection buttons	Scroll the [Settings] menu.
3	Menu area	The menu for the selected page appears here.
4	[Exit] button	Click to close [Setting] menu.

To open a page, use the page selection buttons to select a page then click the tab of the page required. The color of the border of the page selected is light blue.

22.2 File Export

The [File Export] page lets you export setting data, routes, user charts, radar maps, radar installation, and logs (event, application) to a USB flash memory, in .zip file format, to share with other like units.

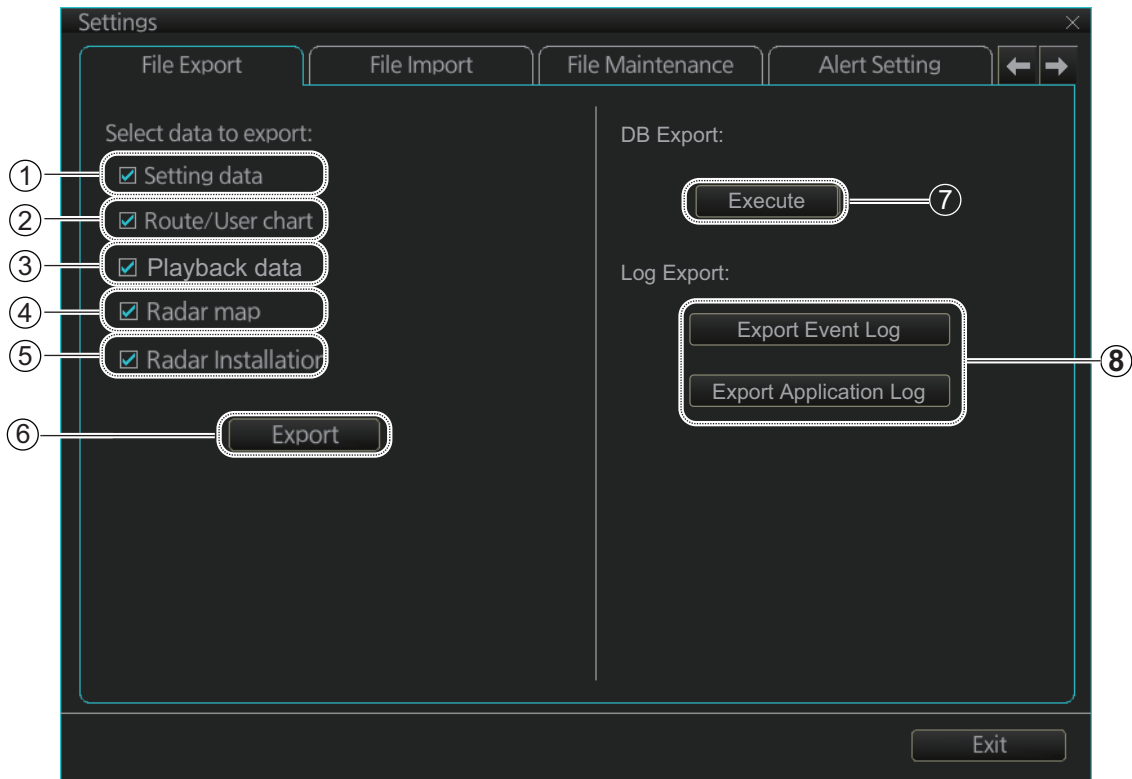

No.	Name	Description
1	[Setting data]	Check to export setting data (radar, chart, conning, common, performance monitor data) and ten user profile data.
2	[Route/User chart]	Check to export all routes and user charts.
3	[Playback data]	No use.
4	[Radar map]	Check to export all radar maps.
5	[Radar Installation]	Check to export all setting of the [RADAR INSTALLATION] menu. The [RADAR INSTALLATION] menu is for service man only.
6	[Export] button	Click the button to open the [SAVE FILE] dialog box. Select the destination to save then click the [Save] button to export all selected objects.
7	[Execute] button	Save the inside check data to SSD. Only service technician can extract the check data.
8	[Export Event Log] button, [Export Application Log] button	Export the (encoded) event log and application log, respectively. The exported file can be sent to an agent or dealer to assist in troubleshooting.

Note 1: Item 5 does not appear until a object is selected.

Note 2: The message "Now processing" appears during the exporting. The message "File export finished." appears upon completion of the exporting. Click the [OK] button.

22.3 File Import

The [File Import] page lets you import setting data, routes, user charts, radar maps and radar installation from an external media (USB flash memory, etc.).

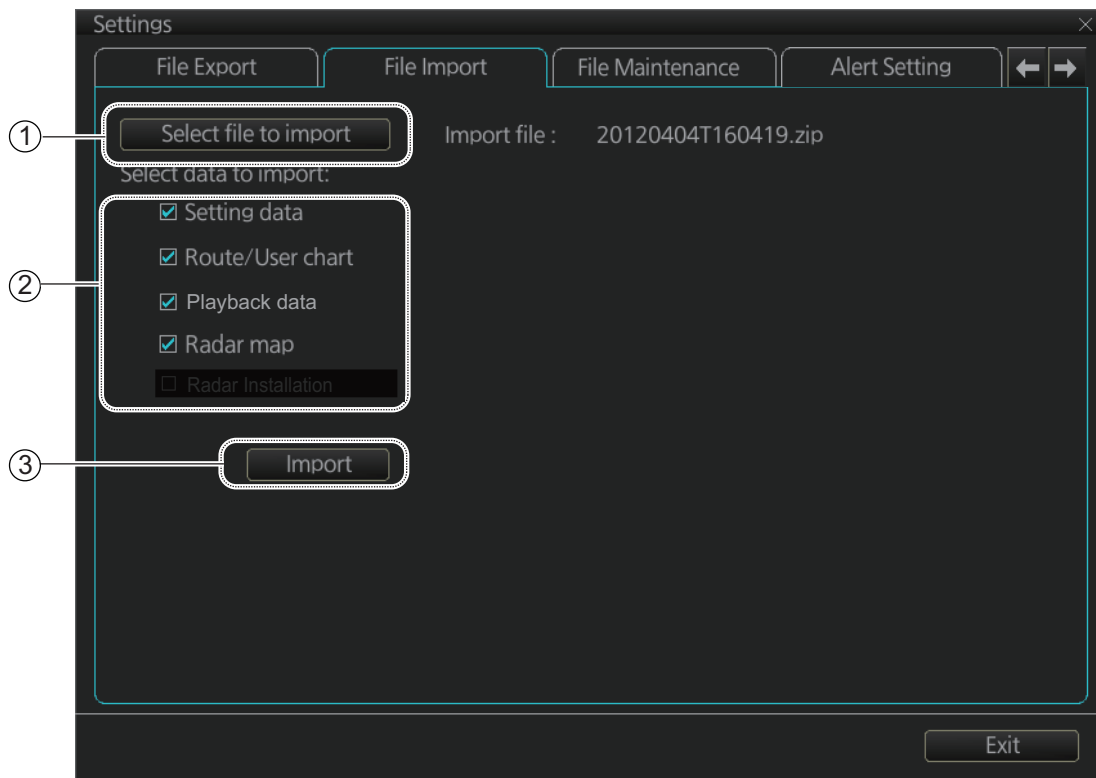

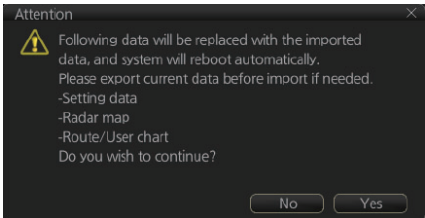
No.	Name	Description
1	[Select file to import] button	Click to show the [OPEN FILE] dialog box, where you can select the file to import.
2	[Select data to import]	Check the data to import, among [Setting data], [Route/User chart] and [Radar map]. Note 1: [Playback data] is no use. Note 2: [Radar Installation] available in Service mode only.
3	[Import] button	Click to import the objects selected. The following message appears on the display. 

Note 1: The system automatically restarts after setting data is imported.

Note 2: If importing could not be completed, first check if the USB flash memory is properly inserted. If inserted properly, try importing again.

Note 3: The [Select data to import] menu does not appear until after a file is selected. The [Import] button appears after the data to import is selected.

Note 4: The message "Now processing" appears during the importing. The message "File import finished." appears upon completion of the importing. Click the [OK] button.

22.4 File Maintenance

The [File Maintenance] page lets you restore the last-saved route/user chart application and route/user chart system.

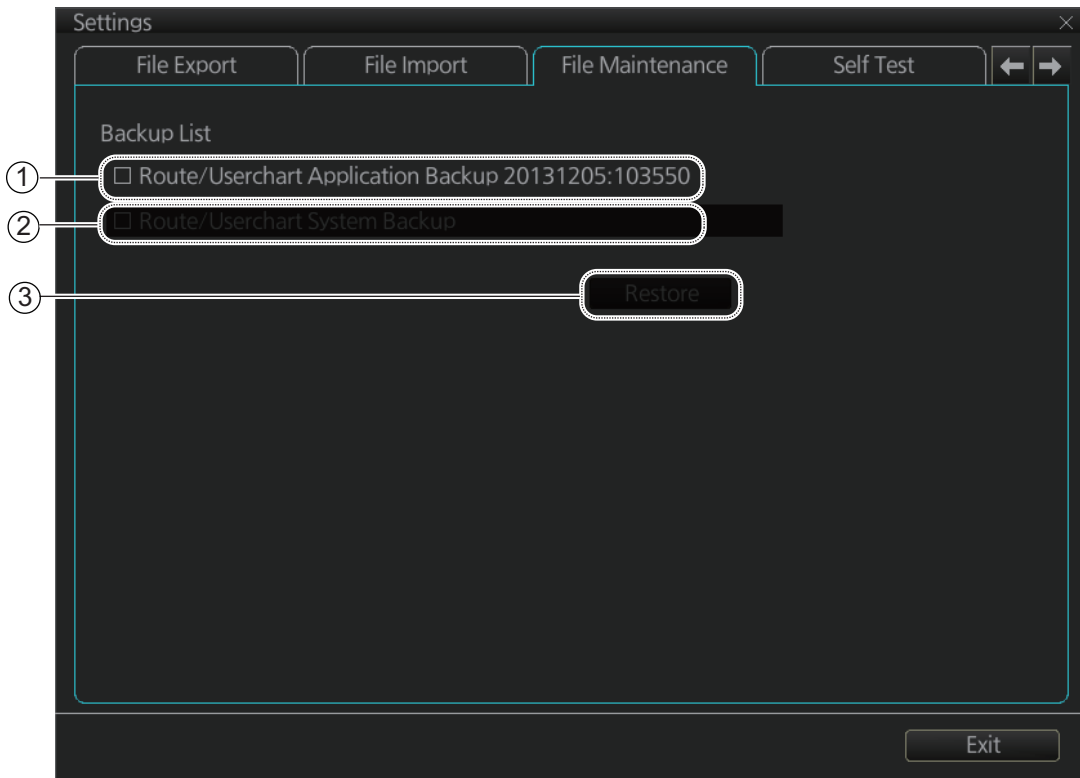

No.	Name	Description
1	[Route/Userchart Application Backup]	Click to restore last-saved route/userchart application.
2	[Route/Userchart System Backup]	Click to restore last-saved route/userchart system.
3	[Restore] button	Click to restore item selected.

Note: To restore the route data from the backup data, first check all route data then do the restore from the latest data.

22.5 Self Test

The [Self Test] page is mainly used to check the equipment. The chart radar is inoperative during the test.

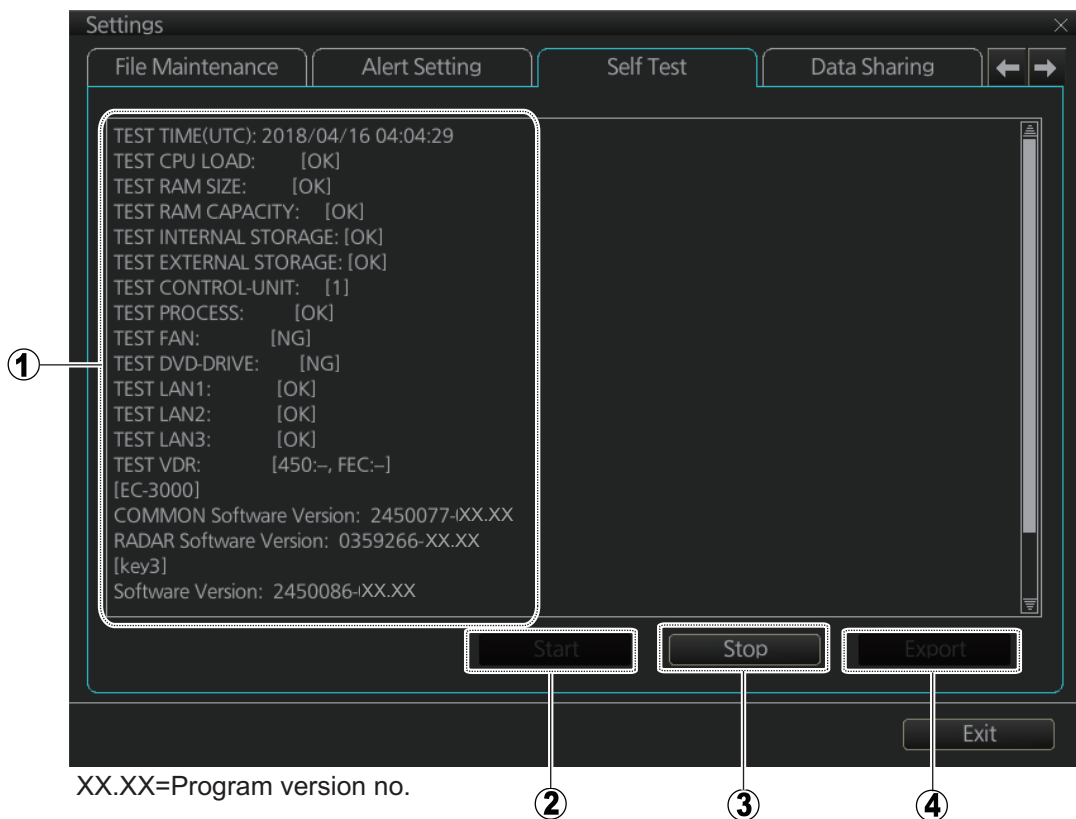

No.	Name	Description
1	Test results, program numbers, SSD info, IP collision, dongle info	<ul style="list-style-type: none"> Self test results Program numbers (subject to change) for each software program SSD's SMART information IP collision check result Dongle information
2	[Start] button	Start the self test.
3	[Stop] button	Stop the self test. (Shown during test.)
4	[Export] button	Export the results of the self test to an external medium (ex. USB flash memory).

Self test results display

The normal results of the boards are shown as follows.

Item	Normal result	
	Magnetron radar	Solid state radar
SPU Status		
12V Power Supply (V)	11.4 - 12.6	
5V Power Supply (V)	4.75 - 5.25	
3.3V Power Supply (V)	3.18 - 3.42	
2.5V Power Supply (V)	2.4 - 2.6	
1.8V Power Supply (V)	1.71 - 1.89	
1.25V Power Supply (V)	1.19 - 1.31	

22. SETTINGS MENU

Item	Normal result	
	Magnetron radar	Solid state radar
1.2V_1 Power Supply (V)	1.14 - 1.26	
1.2V_2 Power Supply (V)	1.14 - 1.26	
3.3V_A Power Supply (V)	3.18 - 3.42	
-10V Power Supply (V)	-10.5 - -9.5	not connect
0.9V_1 Power Supply (V)	not connect	0.86 - 0.94
0.9V_2 Power Supply (V)	not connect	0.86 - 0.94
1.8V_A Power Supply (V)	not connect	1.71 - 1.89
HV (V)	500 - 560	not connect
Magnetron Heater Voltage (V)	<ul style="list-style-type: none"> • X-band 12kW: 8.1 - 8.6 or 6.8 - 7.3 • X-band 25kW: 7.0 - 7.5 or 5.7 - 6.2 • S-band 7.4 - 7.9 or 6.3 - 6.8 	not connect
Magnetron Heater Current (A)	<ul style="list-style-type: none"> • X-band: 0.5 - 0.6 • S-band: 1.1 - 1.4 	not connect
IF 5V Voltage (V)	4.75 - 5.25	not connect
IF -10V Voltage (V)	-10.5 - -9.5	not connect
MD 12V Voltage (V)	11.4 - 12.6	not connect
Antenna Speed (rpm)	<ul style="list-style-type: none"> • Antenna rotation 24 rpm: 22 - 26 • Antenna rotation 42 rpm: 39 - 44 	
Magnetron Current (A)	<ul style="list-style-type: none"> • X-band: 5.0 - 12.0 • S-band: 6.0 - 10.0 	not connect
Trigger Frequency (Hz)	<ul style="list-style-type: none"> • STBY: 0 • [2ND ECHO REJ]=[OFF], TT range*= 24NM: S1: 2640-3360, S2: 2640-3360, M1: 1320-1680, M2: 1060-1340, M3: 880-1120, L: 530-670 • [2ND ECHO REJ]=[OFF], TT range*= 32NM: S1: 1940-2460, S2: 1940-2460, M1: 1320-1680, M2: 1060-1340, M3: 880-1120, L: 530-670 • [2ND ECHO REJ]=[ON]: S1: 2640-3360, S2: 2640-3360, M1: 440-560, M2: 440-560, M3: 440-560, L: 440-560 <p>*: TT range ([MAX RANGE]) is set at the installation.</p>	
LNA Monitor Voltage (V)	0.5 - 1.5	not connect
Tune Indicator (V)	2.0 - 3.0	not connect
Tune Initialize Indicator (V)	2.0 - 3.0	not connect
IF Frequency (MHz)	<ul style="list-style-type: none"> • Pulse length = [S1], [S2]: 0.0 • Pulse length = other than the above settings: 55.0 - 65.0 	not connect
FAN1 Rotation Speed (rpm)	3000 - 5000	not connect
FAN2 Rotation Speed (rpm)	3000 - 5000	not connect
Board Temperature (degC)	-40 - -70	
V TRIG Voltage (V)	10.0 - 18.0	not connect
ROM Check	OK	
RAM Check	OK	

Item	Normal result	
	Magnetron radar	Solid state radar
DIP Switch (SW7-SW0)	Displays the DIP switch settings on the SPU board	
Board Revision Number	Displays the version of the SPU board	
MD Board Revision Number	Displays the version of the MD board	
TX Type	X-12kW/X-25kW/S-30kW	S-Solid
IP Address	Displays IP address of the SPU board	
SPU Error Status	ffff	
MTR-DRV Status		
Board Temperature (degC)	Ambient temperature: below +20°C	
12V Power Supply (V)	9 - 15	
Motor Current (A)	<ul style="list-style-type: none"> • X-band: 24rpm: 0.8 • X-band: 42rpm: 1.2 • S-band: 24rpm: 1.3 • S-band: 42rpm: 2 	<ul style="list-style-type: none"> • 24rpm: 1.3 • 42rpm: 2
Motor Voltage (V)	43 - 53 (33 - 53*) *: For antenna unit installed on the foremast.	
Motor Rotation Speed (rpm)	0 (STBY)/24/36/42	
Board Revision Number	Displays the version of the MTR-DRV board.	
ROM Check	OK	
RAM Check	OK	
PM Status		
12V Power Supply (V)	9 - 15	
PLL Status	<p>For X-band (with board revision number 1 or earlier) and S-band (with board revision number 0): UNLOCK</p> <p>For X-band (with board revision number 2 or later) and S-band (with board revision number 1 or later):</p> <ul style="list-style-type: none"> • PM activated: LOCK • PM inactive: UNLOCK 	<ul style="list-style-type: none"> • PM activated: LOCK • PM inactive: UNLOCK
Board Revision Number	Displays the version of the PM board.	
ROM Check	OK	
RAM Check	OK	
RF-Converter Status		
HPA Board Temperature (degC)	not connect	-40 - 100
6V Power Supply (V)	not connect	4.9 - 8
48V Power Supply (V)	not connect	40 - 53
IF PLL Status	not connect	LOCK
RF PLL Status	not connect	LOCK
Antenna Output Power (dBm)	not connect	48 - 55 (After a restart, requires at least one transmission before the result is shown.)
Board Revision Number	not connect	Displays the version of the RF-CONV board.
ROM Check	not connect	OK
RAM Check	not connect	OK

22. SETTINGS MENU

Item	Normal result	
	Magnetron radar	Solid state radar
Error Status	not connect	not connect
PSU-Control Status		
Board Temperature (degC)	40- 100	
FAN1 Rotation Speed (rpm)	3700- 5700	
FAN2 Rotation Speed (rpm)	3700- 5700	
FAN3 Rotation Speed (rpm)	<ul style="list-style-type: none"> • X-band: 0 • S-band: 3700 - 5700 	
3.3V Power Supply (V)	3.0 - 3.6	
12V_LAN Power Supply (V)	10.8 - 13.2	
12V Power Supply (V)	10.0 - 13.2	
48V Voltage (V)	45.1 - 51.3	
48V Current (A)	0 - 7.5	
Motor1 Voltage (V)	45.1 - 51.3	
Motor2 Voltage (V)	<ul style="list-style-type: none"> • S-band, 42 rpm: 45.1 - 51.3 • Other than above: 100 	
HV (V)	499.6 - 565.5	
Board Revision Number	Displays the version of the PSU CTRL board.	
ROM Check	OK	
RAM Check	OK	
48V Status	OK	
HV Status	OK	
Motor1 Status	OK	
Motor2 Status	OK	
Wave Analyzer		
Error Status	<ul style="list-style-type: none"> • When connected with analysis PC and software: 0000 • Not connected with analysis PC: not connect 	

22.6 Data Sharing

The [Data Sharing] page sets how to share brilliance and color palette settings. select the items to share with the applications in the unit (namely, ECDIS, Radar) and the data to share with other units (other FMD or FAR-3xx0). Uncheck an item to use it locally.

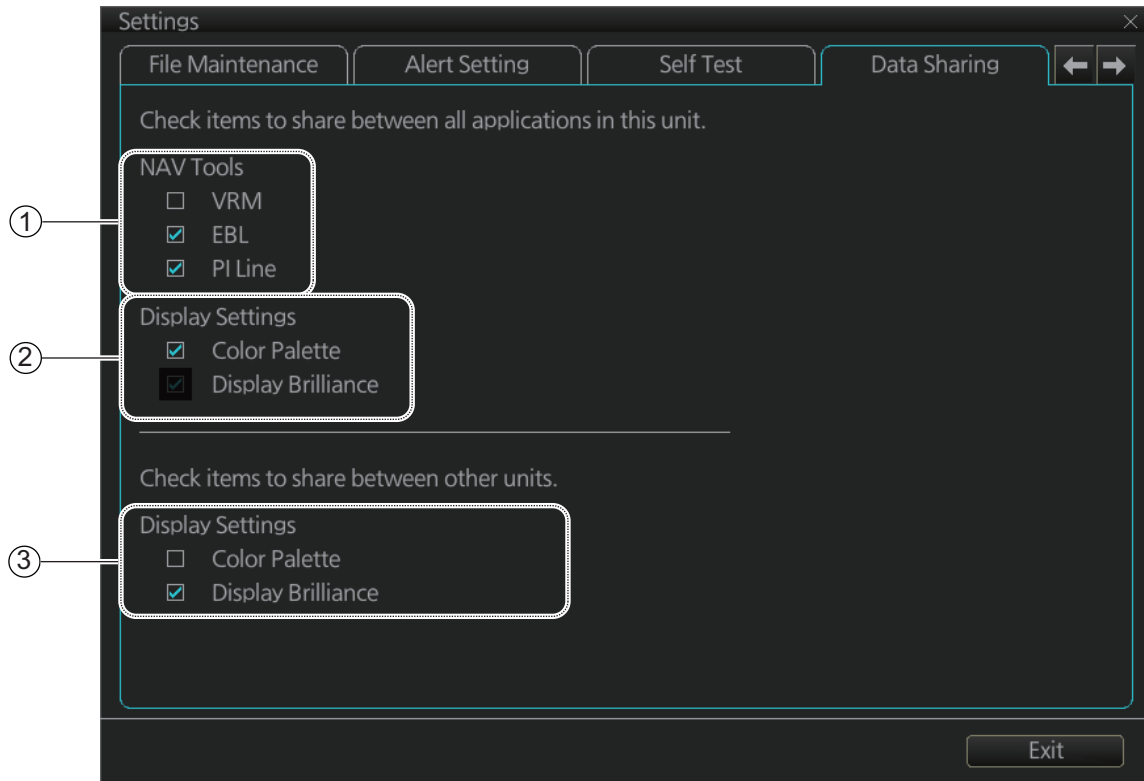

No.	Name	Description
1	[VRM], [EBL], [PI Line]	Check the items you want to share between the applications of this unit (radar function, chart function).
2	[Color Palette], [Display Brilliance]	Check the display settings items you want to share between the applications of this unit (radar function, chart function). The display brilliance setting is reflected to both main and sub displays. Note: Uncheck [Display Brilliance] or [Color Palette] in (3) to activate this setting.
3	[Color Palette], [Display Brilliance]	Set how to share color palette and display brilliance among the units (other FMD-3x00, FAR-3xx0) of the system. Check to share a setting among units, or uncheck to use local setting. After checking an item, a confirmation message appears. Click the [Yes] button to confirm selection. The chosen setting is reflected on the brilliance and color palette buttons on the InstantAccess bar as shown below. See page 1-18 and page 6-8. <ul style="list-style-type: none"> Item checked: "S" appears on the corresponding button to indicate the item is shared among the units of the system. Item not checked: "L" appears on the corresponding button to indicate the item is not shared among the units of the system.

22.7 Customize

The [Customize] page lets you set buzzer volume, key beep volume, and scrollwheel rotation direction.

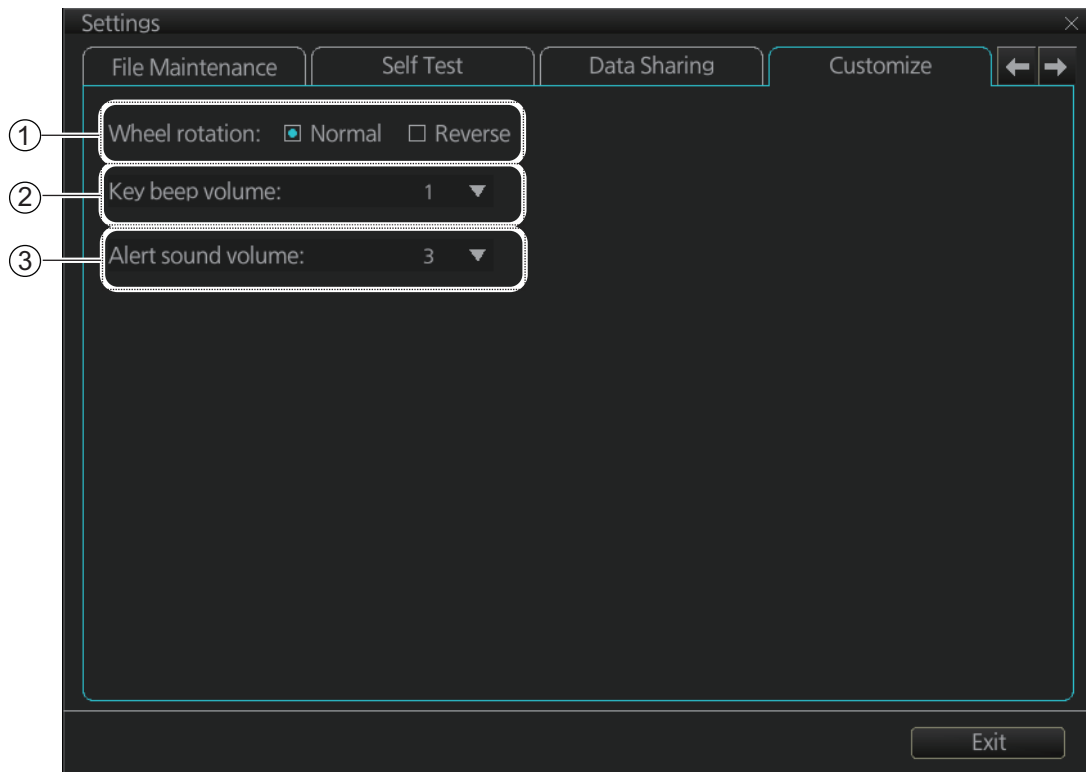

No.	Name	Description
1	[Wheel rotation]	Set the direction of scrollwheel rotation direction. [Normal]: Downward to increase value, upward to decrease value. [Reverse]: Reverse of [Normal].
2	[Key beep volume]	Set the loudness of the key beep that sounds for correct key or mouse button operation. 0: No beep, 1: LOW, 2: MID, 3: HIGH
3	[Alert sound volume]	Set the loudness of the alert buzzer. 1: LOW, 2: MID, 3: HIGH

22.8 Display Test

The [Display Test] page displays various test patterns to check the monitor for proper display of colors. Click the [Display Test] button to start the test. The buzzer sounds when the display test starts.

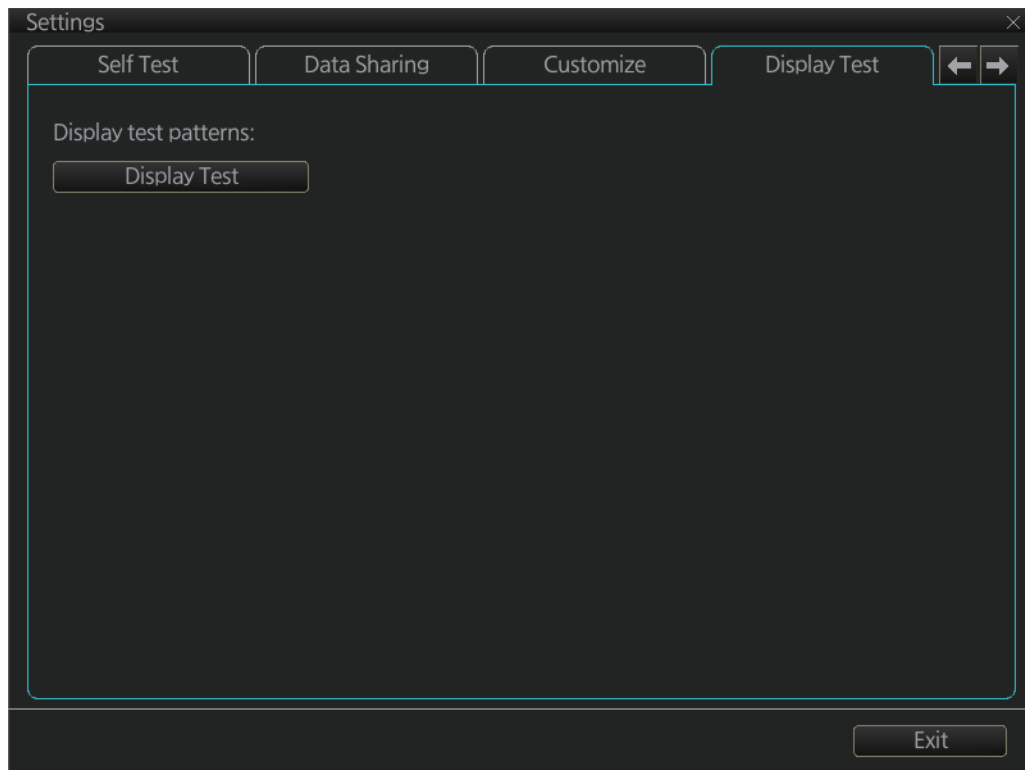

Left-click to proceed in the numerical order shown below; right-click to proceed in reverse order.

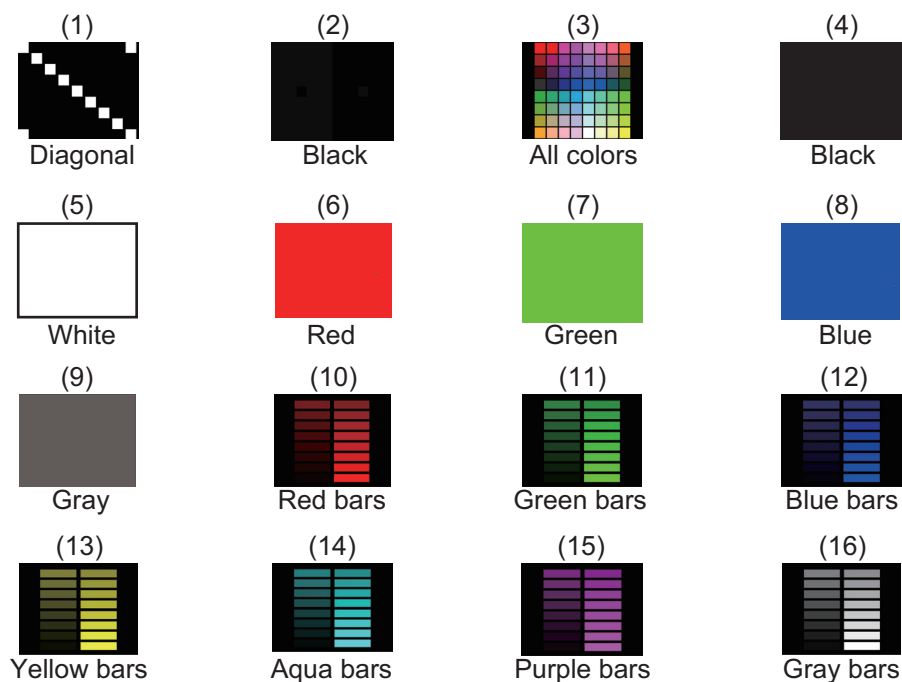

To quit the display test at any time, press the **ESC** key on the applicable Control Unit.

22.9 Keyboard Test

The [Keyboard Test] page checks the controls and keys on the Radar Control Unit and the ECDIS Control Unit and the trackball module on the Radar Control Unit, ECDIS Control Unit and Trackball Control Unit.

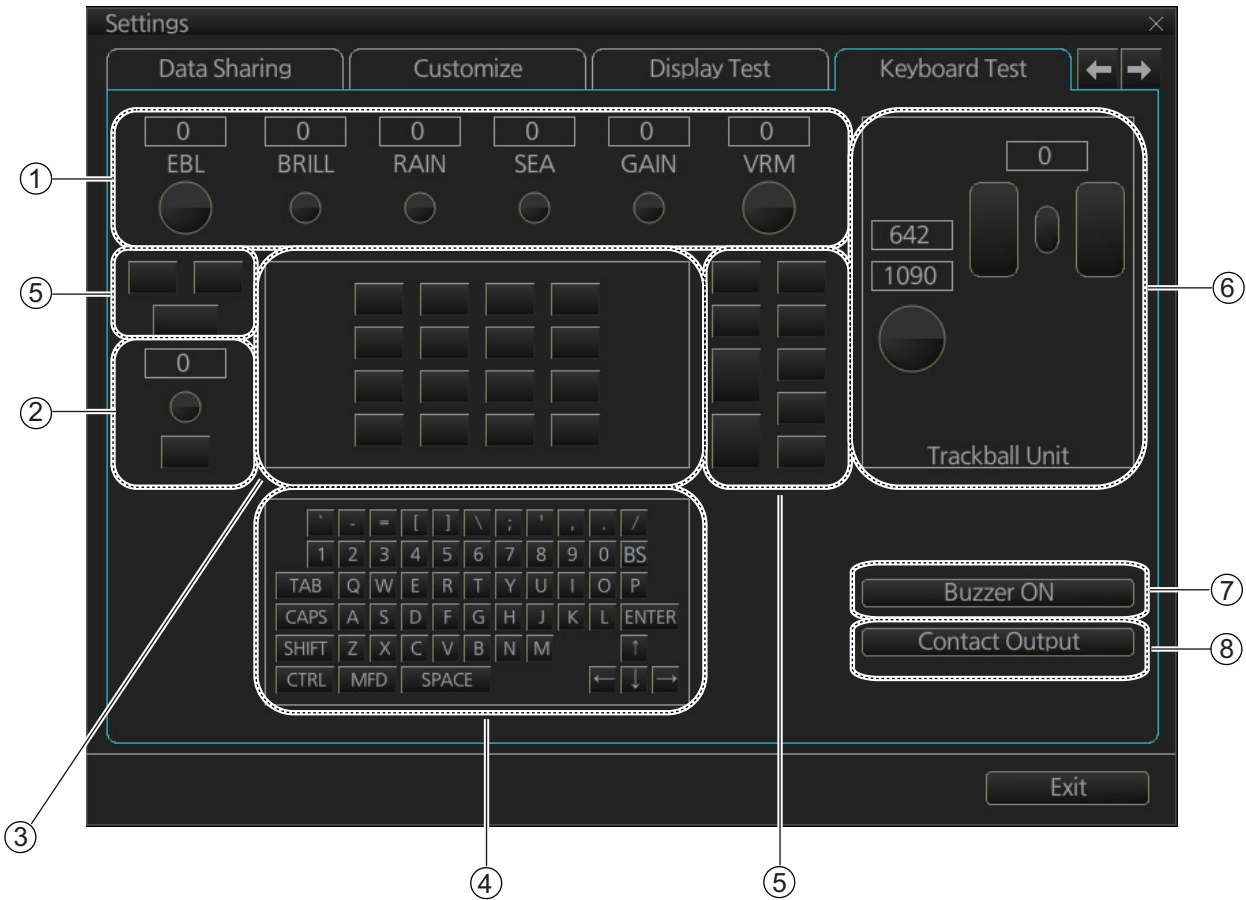

No.	Name	Description
1	Common controls	Operate the corresponding controls on the Radar Control Unit and chart radar Control Unit. Rotate a control and the window above the control shows the setting value. Push a control and the corresponding location on screen lights in light blue. (The EBL and VRM controls do not have a push function.)
2	InstantAccess knob/key	Check the InstantAccess knob and key. 1) Rotate the knob and the setting value appears in the window. 2) Push the knob and the knob lights in light blue. 3) Push the key and the key lights in blue.
3	Keys of the Radar Control Unit	Operate each key. The key pressed lights in light blue.
4	Keyboard of the chart radar Control Unit	Operate each key. The key pressed lights in light blue.

No.	Name	Description
5	Keys of both the Radar Control Unit and chart radar Control Unit	Operate each key. The pressed key lights in light blue.
6	Trackball module	Check the trackball module of a Control Unit: 1) Spin the scrollwheel and rotate the trackball. The indication above the operated control shows the setting value. 2) Push each button. The window above a pushed button lights in light blue. 3) Push the scrollwheel. The window above the wheel lights in light blue.
7	[Buzzer ON] button	Click the [Buzzer ON] button to sound the buzzer. The buzzer sounds and the button flashes (in red). Click the button again to cancel.
8	[Contact Output] button	Click the [Contact Output] button to output the Alarm output contact signal from the Processor Unit. Click the button again to cancel.

22.10 Screenshots

The [Screenshot] page handles the exporting (to a USB flash memory) and deleting of screenshots from the SSD.



No.	Name	Description
1	List	List of screenshots taken. Screenshots are automatically assigned a file name consisting of the time and date the screenshot was taken.
2	Check boxes	Put a checkmark in the box of the screenshot to process.
3	[Preview]	Preview of the screenshot selected.
4	[Delete] button	Delete the screenshot(s) selected.
5	[Export] button	Export selected screenshot(s) to a USB flash memory.
6	[Print] button	Print the screenshot selected.
7	[Apply] button	Save comment.
8	[Comment] box	Enter comment for screenshot. Put a check in appropriate checkbox then enter comment.

22.10.1 How to export screenshots

You can export screenshots to a USB flash memory as follows:

1. Insert a USB flash memory in the USB port on the Control Unit.
2. Open the [Screenshot] page.
3. Put a checkmark in the checkbox of the screenshot(s) to export.
4. Click the [Export] button.

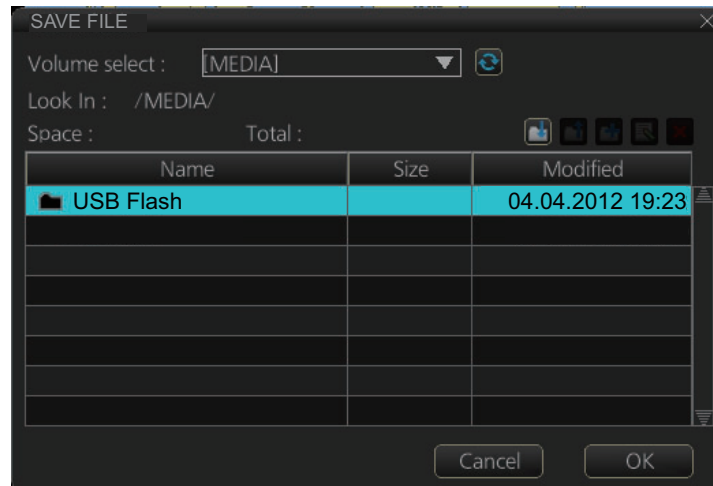

5. Select the USB flash memory.
6. Click the [OK] button to export the screenshots selected.
7. If the exporting was successful, a window showing the number of files exported appears. Click the [OK] button to finish.

22.10.2 How to delete screenshots

You can delete the screenshots saved in the SSD inside the EC-3000.

1. Select the [Screenshot] page.
2. Put a checkmark in the checkbox of the screenshot(s) to delete. To select all screenshots, right-click the box to the left of the [Date] column then select [Select all]. To clear all check marks, select [Clear all].
3. Click the [Delete] button. The confirmation message "Attention: Selected files will be deleted. Do you wish to continue?" appears.
4. Click the [Yes] button to delete the screenshots selected. The message "File deletion succeeded" appears.
5. Click the [OK] button.

22.10.3 How to print screenshots

With connection of a printer you can print the screenshots stored in the SSD of the processor unit.

1. Select the [Screenshot] page.
2. Select the screenshot to print. Note that multiple screenshots cannot be printed at the same time.
3. Click the [Print] button.
4. Click the [OK] button to finish.

22.11 User Default

The [User Default] page restores all default settings for [Radar menu], [Chart menu], [User profile] and [Setting menu]. Click the [Restore User Setting] button. The message "All setting data will be restored to the default. Do you wish to continue?" appears. Click the [Yes] button to restore default settings and reset the power.

If you require the setting data, copy it to a USB flash memory (using the file export feature), BEFORE restoring user defaults.

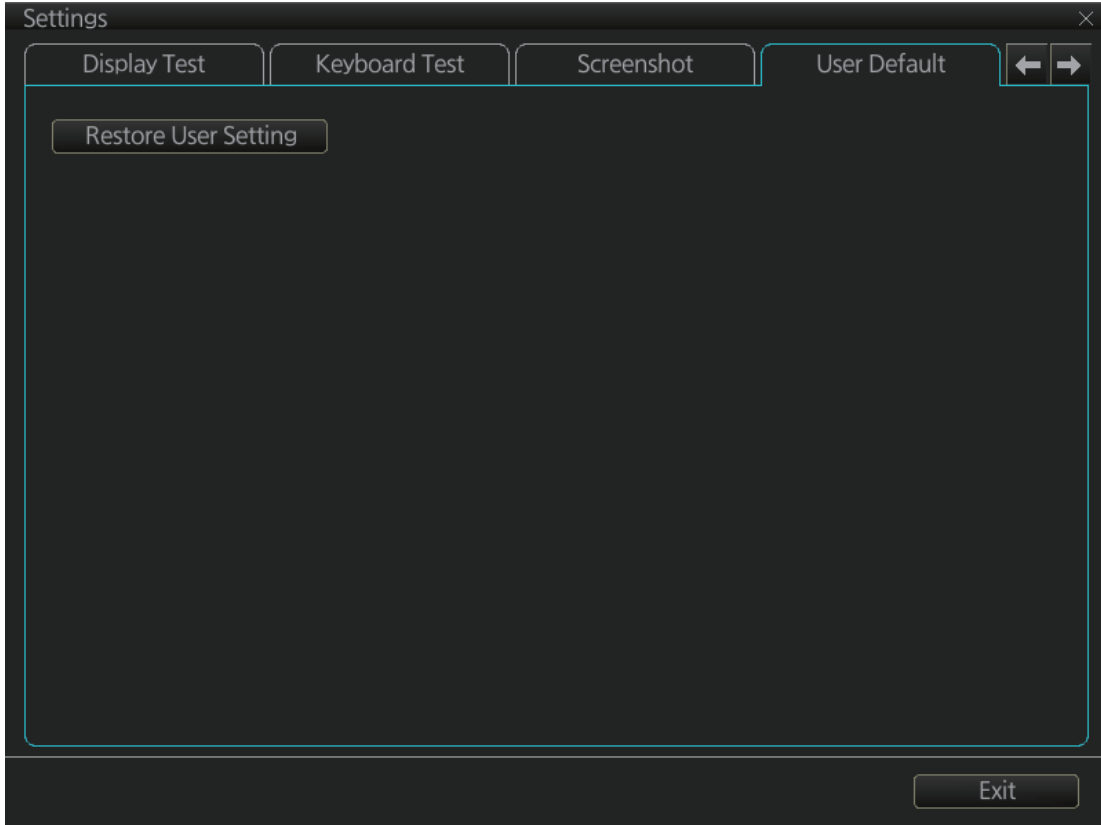

22.12 CCRP

The [CCRP] page provides for selection of CCRP (Consistent Common Reference Point) and shows the location of various sensors.

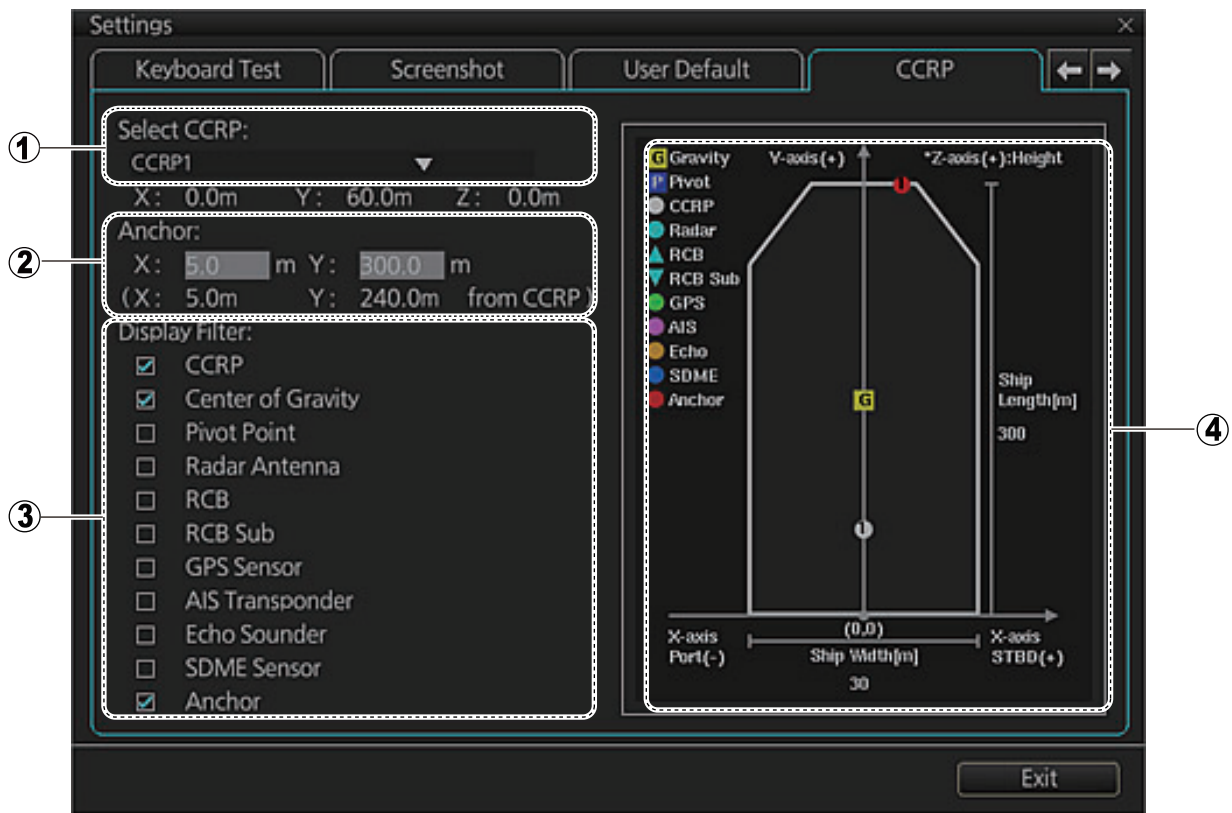

No.	Name	Description
1	CCRP	Select the CCRP to use in the case of multiple CCRPs.
2	Anchor	Enter anchor installation position (X and Y values from CCRP). The setting ranges are X, -15.0 to 15 m; Y, 0.0 to 300.0 m.
3	Display Filter	Check the items to show on the ship's graphic.
4	Ship's graphic	Shows the location of the sensors selected at the [Display Filter].

This page is intentionally left blank.

23. COMMON REFERENCE SYSTEM

23.1 Installation of the System

Special attention of following topics is required to maintain the "Common Reference System." The origin of the common reference system is the conning position on vessel.

- The values of the center and conning positions depend on the size and geometry of the ship.
- Offsets from the antenna position to the conning position of position sensors depend on the location of the antennas of the position sensor.
- Offsets from the antenna position to the conning position of the radars depend on the location of the radar antennas.

23.2 Accuracy of the System

Accuracy depends on the following conditions:

- Gyro error referenced to chart orientation
- Accuracy of EPFS
- Accuracy of radar performance and display (see the specifications at the back of this manual).
- Accuracy of setting of CCRP (see section 2.33)

The following items must be properly adjusted to meet the above conditions:

- Timing (Tx timing of radar echo). Timing is adjusted from the [RADAR INSTALLATION] menu, accessible by the service technician. Contact a FURUNO dealer for details.
- Heading (Adjustment of radar echo heading). Heading is adjusted from the [RADAR INSTALLATION] menu, accessible by the service technician. Contact a FURUNO dealer for details.
- Radar ANT position (Center of radar image is the radar antenna position). Radar antenna position is set on the [Common Installation Settings] menu, accessible by the service technician. Contact a FURUNO dealer for details.
- Conning position:
 - The chart radar uses position data fed from a GPS navigator to calculate the latitude and longitude position of the conning position.
 - GPS antenna position and conning position are entered during the installation. GPS antenna and conning positions are set on the [Common Installation Settings] menu, accessible by the service technician. Contact a FURUNO dealer for details.
 - The latitude and longitude position displayed at the top-right position on the screen is the latitude and longitude position of the conning position.
 - The chart datum used by the chart radar is recorded in geodetic datum WGS-84; therefore, the geodetic datum setting on the GPS navigator must be WGS-84.

23. COMMON REFERENCE SYSTEM

- Gyro data:
 - Serial format gyro data is fed directly from a gyrocompass, thus adjustment of the heading indication on the chart radar is not necessary.
 - If synchro or stepper gyro data is fed to the chart radar, the heading indication on the chart radar must be adjusted to match that of the gyro. For the adjustment procedure, see section 1.17.
- Speed data:
 - Speed may be input from SDME or GPS.
 - SDME may be single-axis water speed or dual-axis ground speed.
 - GPS may be used to input COG/SOG.
 - Ground speed may also be taken from TT reference target.
 - Speed is entered from the [Setting] menu. For details, see section 1.16.

24. CONNING (optional specification)/MINI CONNING/SIDE CONNING

24.1 Conning Display

The conning display provides relevant sensor information data (including engine data) from external equipment, on one display to facilitate safe and efficient monitoring. The ECDIS accepts sensor information data in analog, serial and contact signal formats.

Six sets of conning displays are available, and they are arranged at installation. Consult with the installer of the equipment to decide the content and layout of each display.

To show the conning display, click the Operating Mode button on the Status bar to select [CONNING for RADAR].

Note: Analog data is shown in the lowest value of the setting range when the data is not input.



Note: The cursor can be moved between the main monitor and a sub monitor and vice versa if the sub monitor is configured to show the Conning display. Push the scrollwheel until the cursor moves to the other monitor.

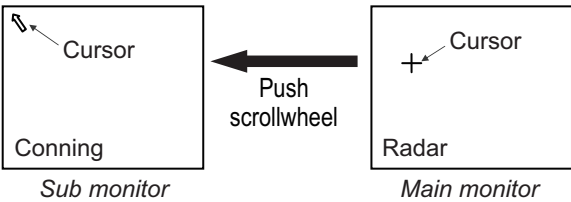

Conning display Status bar



No.	Button	Description
1	Operating mode	Selects the operating mode, [RADAR], [CHART for RADAR] or [CONNING].
2	Conning display sheet	Selects the conning display sheet to use, Sheet.1 - Sheet.6. (Sheet name is decided at installation. "Sheet x" (x=sheet number) is the default sheet name.)
3	[SILENT]	Goes to the [SILENT] mode. See section 6.7.
4	[TOOL]	Shows, hides the software keyboard; adjusts the volume of the key beep and audio alert. <div style="text-align: center;"> <p>Shows, hides software keyboard Adjusts volume of key beep, audio alert</p> <p>To adjust a volume, put cursor in applicable box.</p> <p>Click up arrow to raise volume; down arrow to lower volume.</p> </div>
5		Selects a display palette. See section 1.5. The indication on the button changes according to the [Data Sharing] page. The default setting is "S". See section 22.6.
6		Adjusts the brilliance of a the monitor. See section 1.6. The indication on the button changes according to the [Data Sharing] page. The default setting is "S". See section 22.6.
7		Takes a screenshot. See section 1.21.
8		Displays AMS and conning software version and system information. The information shown in the figure may differ from your own. For System and System 2 see section 1.24.
9	Date	See section 1.20.
10	Time	See section 1.20.

No.	Button	Description
11	Status Indicator 	<ul style="list-style-type: none"> Rotates clockwise if the system is working properly. If it is not spinning the system is not working. Shortly after the working indicator stops spinning the buzzer sounds and the status LED turns red. Reset the power to restore normal operation. If the primary display mode is specified during installation, the first letter of the primary mode name appears at the center of the working indicator as follows: C: Conning, E: ECDIS, R: Radar. The letter can be clicked to return to the primary display mode.

24.2 Conning Display Examples

Six conning display sheets are available, and the content, layout and name of each sheet can be customized, by the service technician. Below are some examples conning display sheets.

Example 1 (General navigation)

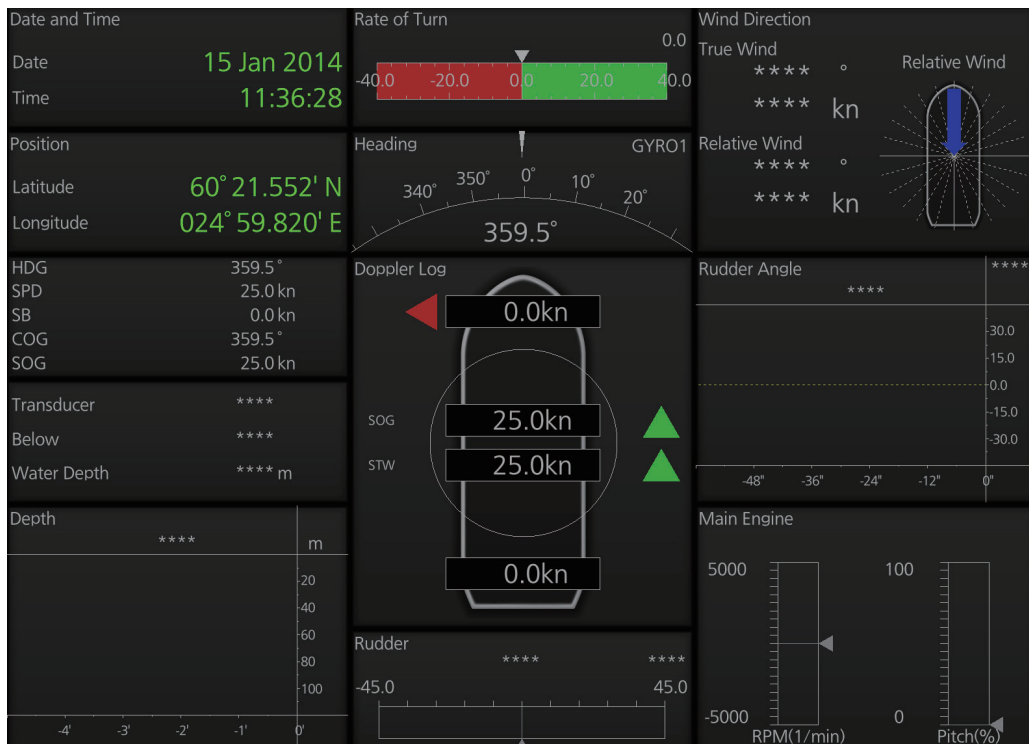

24. CONNING (optional specification)/MINI CONNING/SIDE CONNING

Example 2 (General navigation)



Example 3 (General navigation)

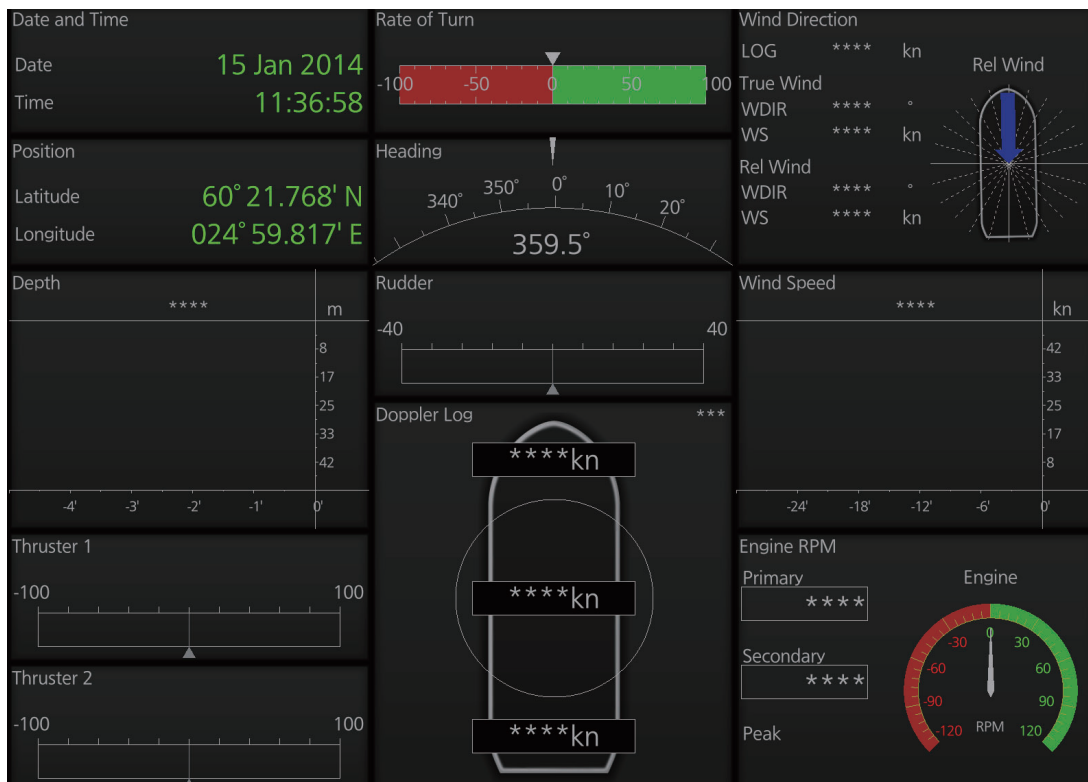

Example 4 (General navigation)



Example 5 (General navigation)



24. CONNING (optional specification)/MINI CONNING/SIDE CONNING

Example 6 (All waters, navigation)

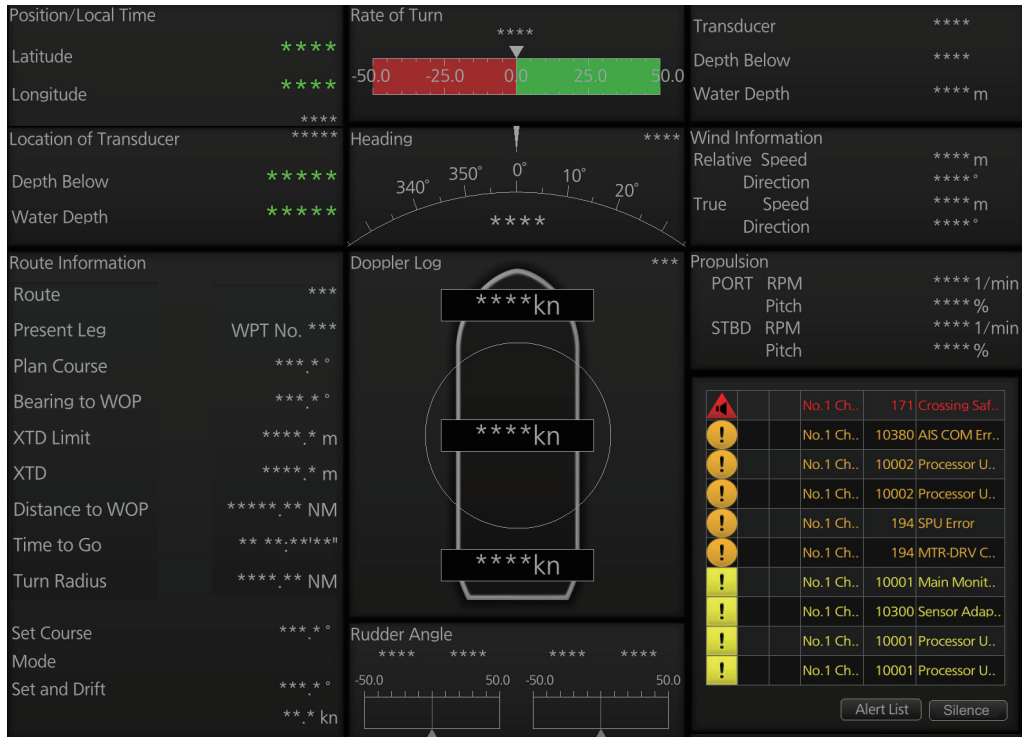

Example 7 (All waters, harbor)

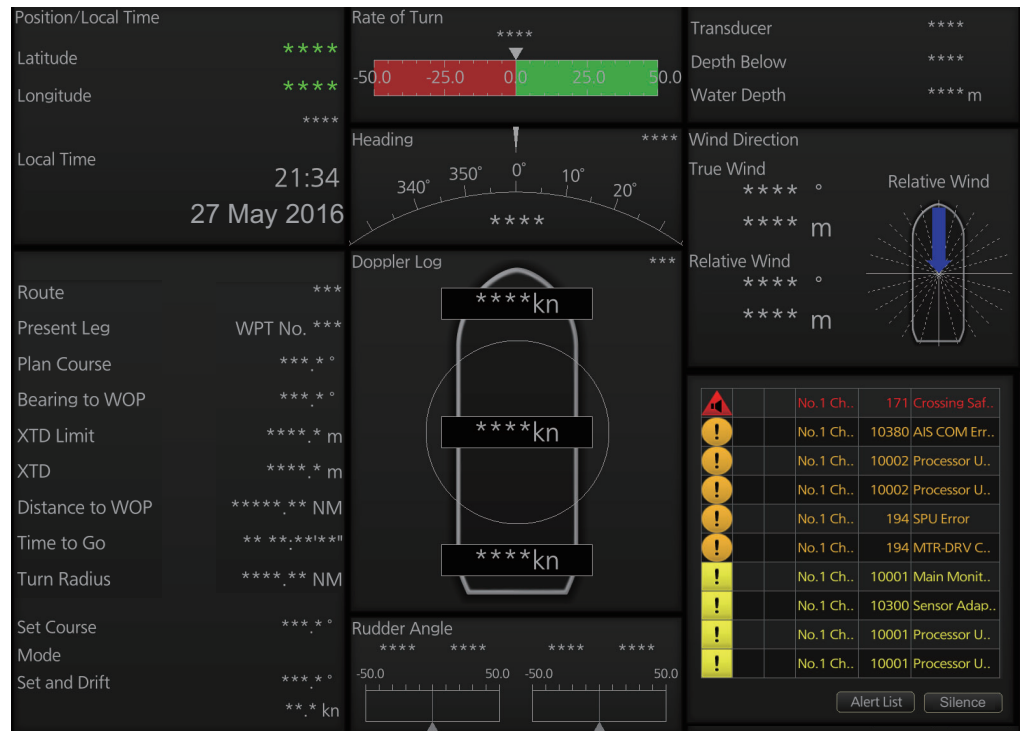

Example 8 (Ocean. navigation)

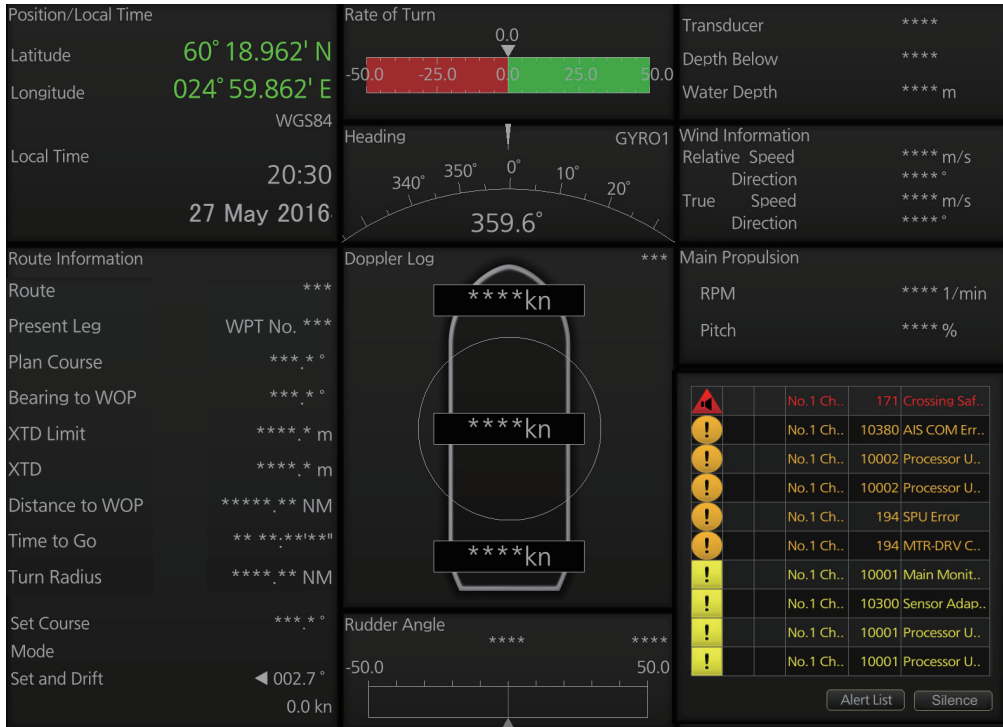

Example 9 (Ocean. harbor)

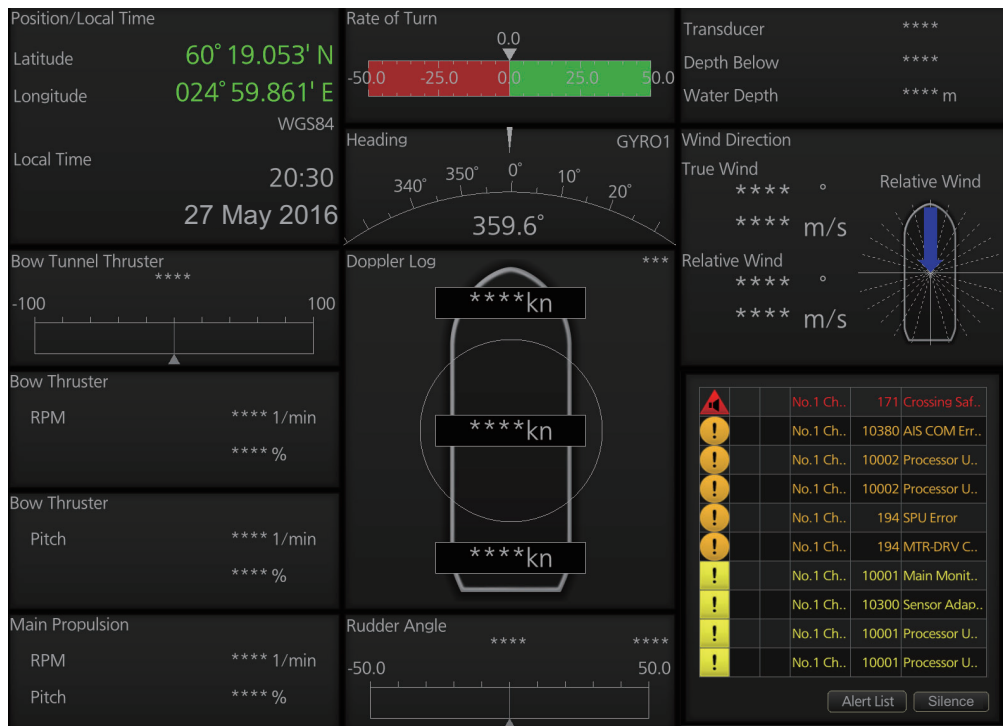

24. CONNING (optional specification)/MINI CONNING/SIDE CONNING

Example 10 (Ocean, harbor)



Example 11 (Ocean, harbor)



Example 12 (Offshore Service Vessel. Fore 1)

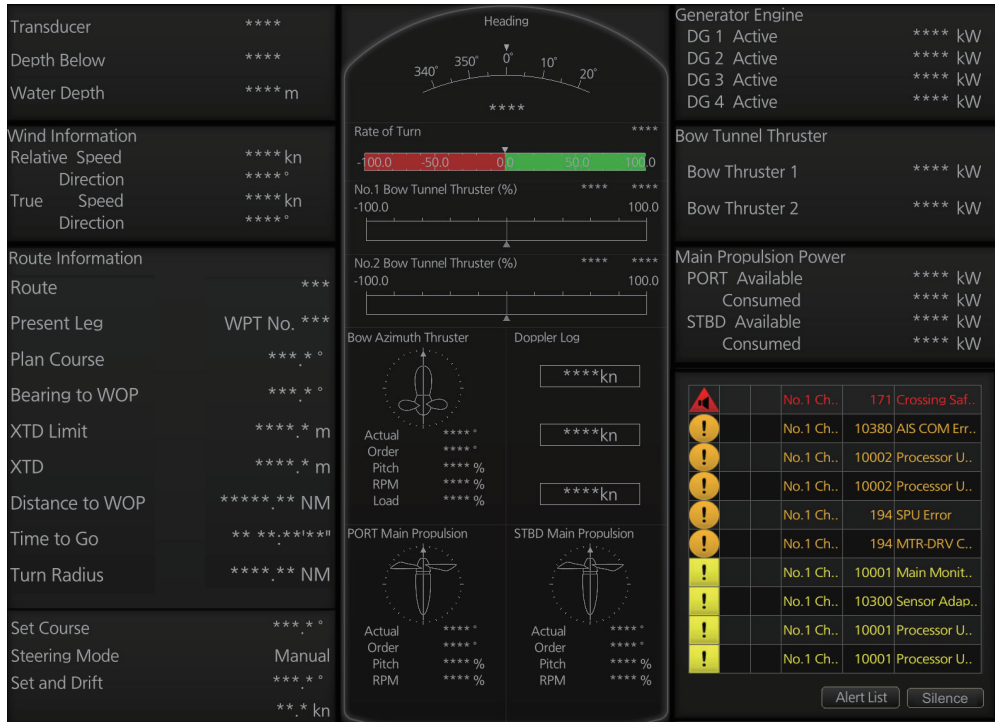

Example 13 (Offshore Service Vessel. Fore 2)

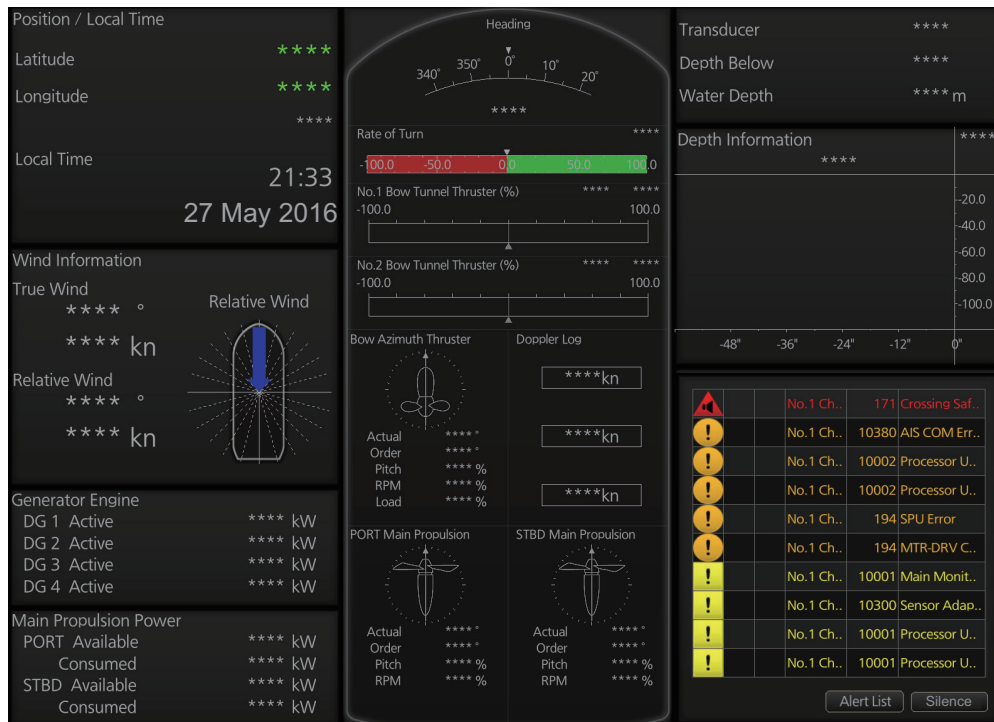

24. CONNING (optional specification)/MINI CONNING/SIDE CONNING

Example 14 (Offshore Service Vessel. Aft 1)

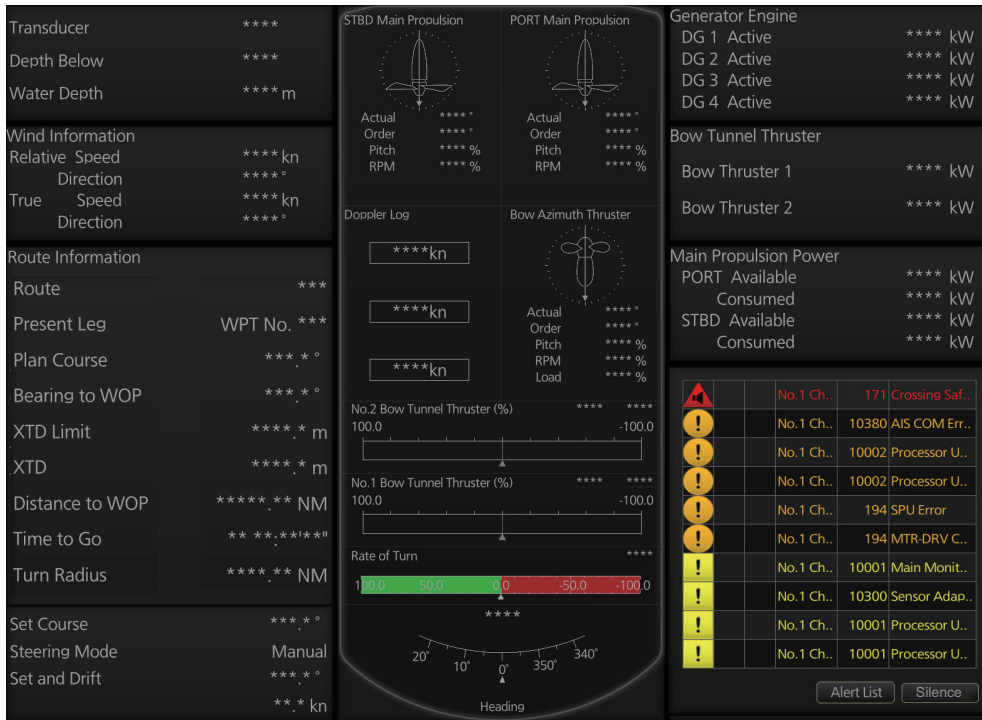

Example 15 (Offshore Service Vessel. Aft 2)

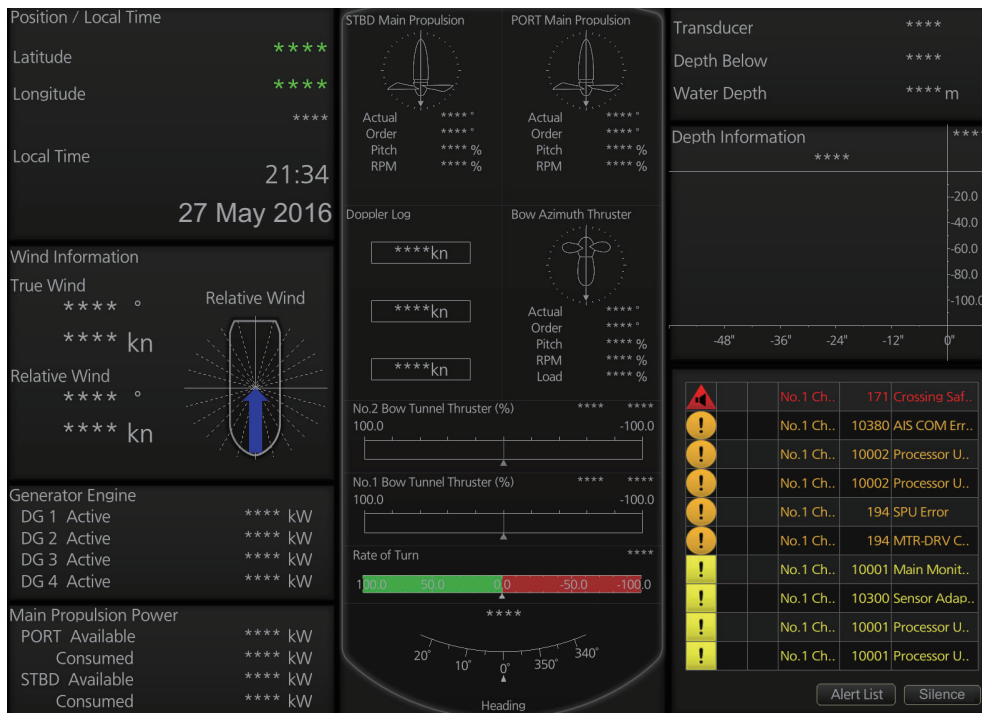

24.3 Mini Conning Display

The mini conning display, available in the Voyage navigation mode, provides various navigation information and is set during the installation. The display example below shows heading, doppler log speed and rudder angle. To show or hide the mini conning display, click the [Mini Conning] button on the InstantAccess bar™.

To shift the mini conning display, right-click the mini conning display to show the context-sensitive menu. Click an option: [Left Top], [Left Middle], [Left Bottom], [Right Top], [Right Middle] or [Right Bottom].

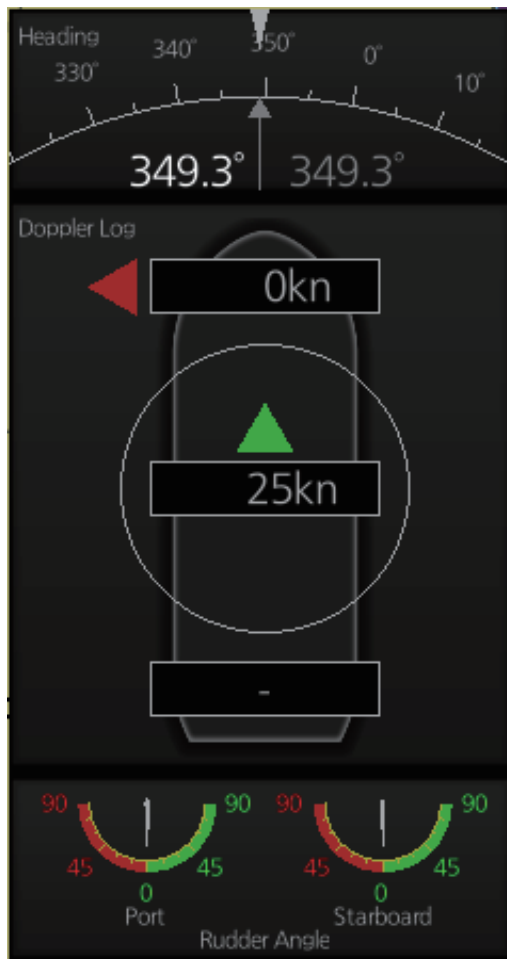

24.4 Side Conning Display (landscape monitor only)





With the landscape monitor, the side conning display can be shown in the information area, in the radar mode. The presence or absence of the display is determined during the installation.

Four side conning sheets are preset during the installation according to expected usage, possible navigation conditions, etc. (The operator cannot modify the sheets.) You can select a sheet by clicking the current sheet name at the top right corner on the display.



25. MAINTENANCE AND TROUBLESHOOTING

Periodic checks and maintenance are important for proper operation of any electronic system. This chapter contains maintenance and troubleshooting instructions to be followed to obtain optimum performance and the longest possible life of the equipment. Before attempting any maintenance or troubleshooting procedure please review the safety information below. If you cannot restore normal operation after following the troubleshooting procedures, do not attempt to check inside any unit; there are no user-serviceable parts inside. Refer any repair work to a qualified technician.

	WARNING
	Do not open the equipment. Hazardous voltage which can cause electrical shock exists inside the equipment. Only qualified personnel should work inside the equipment.
	Turn off the radar power switch before servicing the antenna unit. Post a warning sign near the switch indicating it should not be turned on while the antenna unit is being serviced. Prevent the potential risk of being struck by the rotating antenna.
	A transmitting radar antenna emits electromagnetic waves, which can be harmful, particularly the eyes.
	Wear a safety belt and hard hat when working on the antenna unit. Serious injury or death can result if someone falls from the radar antenna mast.

NOTICE
Do not apply paint, anti-corrosive sealant or contact spray to coating or plastic parts of the equipment. Those items contain organic solvents that can damage coating and plastic parts, especially plastic connectors.

25.1 Maintenance

Regular maintenance is essential to good performance. A regular maintenance program should be established and should at least include the items shown in the table below.

Maintenance schedule

Interval	Check point	Check and measures	Remarks
When needed	FURUNO-supplied monitor unit and Processor Unit	Dust or dirt may be removed from a cabinet with a soft cloth. Water-diluted mild detergent may be used if desired. DO NOT use chemical cleaners to clean the display unit; they may remove paint and markings. To clean the LCD, wipe the LCD carefully to prevent scratching, using tissue paper and an LCD cleaner. To remove dirt or salt deposits, use an LCD cleaner, wiping slowly with tissue paper so as to dissolve the dirt or salt. Change paper frequently so the salt or dirt will not scratch the LCD. Do not use solvents such as thinner, acetone or benzene for cleaning. Also, do not use a degreaser or an antifog solution, as they can strip the coating from the LCD.	Do not use chemical-based cleaners for cleaning. They can remove paint and markings.
	Filter inside Processor Unit	Have a technician clean the filter if it is dusty. See section 25.4.	
5 years	Antenna Unit	If the grease dries out the V ring may break, allowing water to leak inside the antenna unit.	Have a qualified technician apply the grease oil to the antenna rotary.
3 to 6 months	Cabling	Check that all cabling is firmly connected and is not damaged.	
	Exposed bolts and nuts of antenna unit	Exposed bolts and nuts are subject to corrosion. Further, they may loosen by vibration.	Check that bolts and nuts are not corroded and are securely fastened. If corroded, clean and coat with anticorrosive sealant.
	Adhesive (marine sealant) on nuts and bolts	Check for deteriorations such as splits and peeling. Re-apply as required. For areas with extensive deterioration, remove the existing adhesive before re-applying a fresh coat.	Adhesive deterioration can result in water leakage, which can cause corrosion.

Interval	Check point	Check and measures	Remarks
3 to 6 months	Radiator	Dust, dirt and salt deposits on the radiator cause signal attenuation, resulting in loss of sensitivity. Wipe radiator with a freshwater-moistened cloth.	The radiator is made of fiberglass reinforced plastic. Therefore, do not use gasoline, benzene and the like to clean the radiator. If the radiator is iced, use a wooden or plastic headed hammer to remove the ice. DO NOT use a steel hammer.
	Terminals, connectors	Check that all terminals and connectors on circuit boards are securely fastened.	Have a qualified technician check terminals and connectors.
6 months to 1 year	Screws on terminal boards in Processor Units	Check that all screws are tightly fastened.	Have a qualified technician check screws.

25.2 How to Replace the Fuses

The fuse in the following units protects those units from overvoltage (overcurrent) and internal fault. If a unit cannot be turned on, check if its fuse has blown. If the fuse has blown, find out the cause before replacing the fuse. If the fuse blows again after replacement, contact your dealer for advice.



WARNING

Use the proper fuse.

Use of a wrong fuse can damage the equipment or cause fire.

Unit	Power supply	Type	Code no.
Power Supply Unit PSU-014	100-230 VAC	F1: FGBO-A 250V 7A PBF	000-178-084-10
Power Supply Unit PSU-015	100-230 VAC	F1: FGBO-A 250V 3A PBF F2: FGBO-A 250V 7A PBF	000-155-841-10 000-178-084-10
Power Supply Unit PSU-016	100-230 VAC	F1: FGBO-A 250V 5A PBF	000-155-840-10
Power Supply Unit PSU-018	100-230 VAC	F1: FGBO-A 250V 3A PBF F2: FGBO-A 250V 7A PBF	000-155-841-10 000-178-084-10
Monitor Unit	Refer to the Operator's Manual for the Monitor Unit.		
Processor Unit EC-3000	100-115 VAC	FGMB-S 125V 10A PBF	000-157-470-10
	220-230 VAC	FGMB-A 250V 5A PBF	000-157-570-10
Sensor Adapter MC-3000S	24 VDC	FGMB-A 125V 3A PBF	000-157-481-10
Antenna Unit*	100-115/ 220-230 VAC	FGBO-A 250V 3A PBF	000-155-841-10

*: Only for configurations with the De-icer Kit installed.

25.3 Trackball Maintenance

If the cursor moves abnormally, clean the trackball and inside the trackball housing (including the lens) as shown below:

1. Turn the retaining ring on the trackball module in the direction of the arrows (see figure below) to unlock it, then remove the retaining ring.

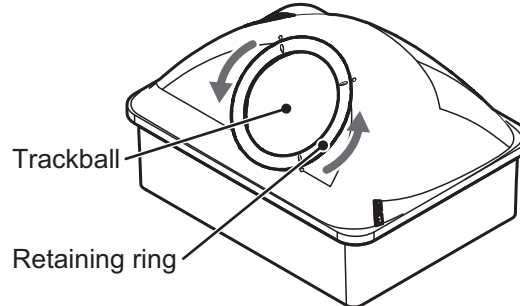

2. Use cellophane tape to remove the trackball from the trackball housing. Place the trackball and the retaining ring on clean, soft cloth laid on a flat surface.
3. Clean the ball with a damp, soft cloth, then use a dry, lint-free cloth to carefully wipe the ball dry.
4. Use a swab, moistened with water, to carefully clean the inside of the retaining ring, the inside of the trackball housing, the supports and the lens. Change the swab regularly so that dirt and dust build-up is easily removed.

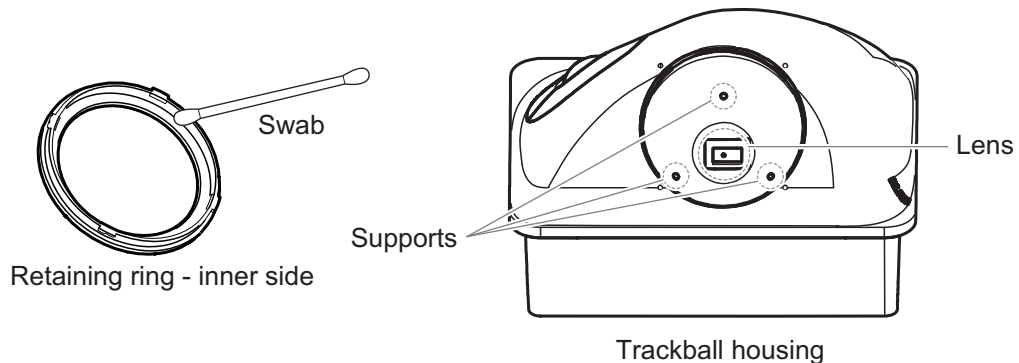

5. Make sure that the trackball, trackball housing and retaining ring are completely dry.
6. Re-set the ball and retaining ring. Be sure the retaining ring is not inserted reversely.

25.4 How to Clean and Replace the Air Inlet Filter

25.4.1 EC-3000 Processor Unit

Clean the air inlet filter in the Processor Unit when it becomes dusty. Turn the Processor Unit off, then remove the filter and clean it with water and a mild detergent. Rinse the filter, allow the filter to dry then return it to the Processor Unit.

Note 1: Be sure the air inlet is not blocked. A blocked inlet can cause the temperature to rise inside the cabinet, which can lead to malfunction.

Note 2: The right side of the Processor Unit has an exhaust vent. Remove dust from the vent as necessary.

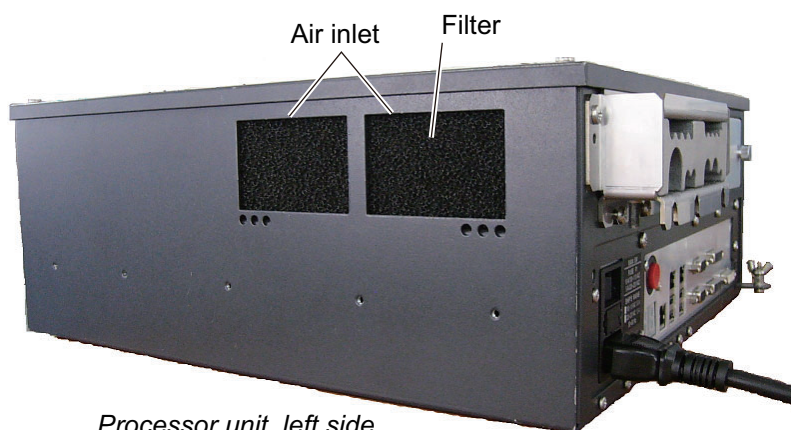

Processor unit, left side

If the filter appears brittle and leaves residue on your hands when dry, replace the filter.

For filter replacement, consult your local dealer and quote the following details:

Part number: 24-014-0105	Code: 100-366-821-10
--------------------------	----------------------

25.4.2 RCN-303/304 Console Units

The console unit air filters are fitted on the inside of the console units and are not accessible normally. The figures below show the locations of each air filter.

Note: The monitor size may differ, depending on the configuration purchased. The figures below are for reference only and are not to scale.

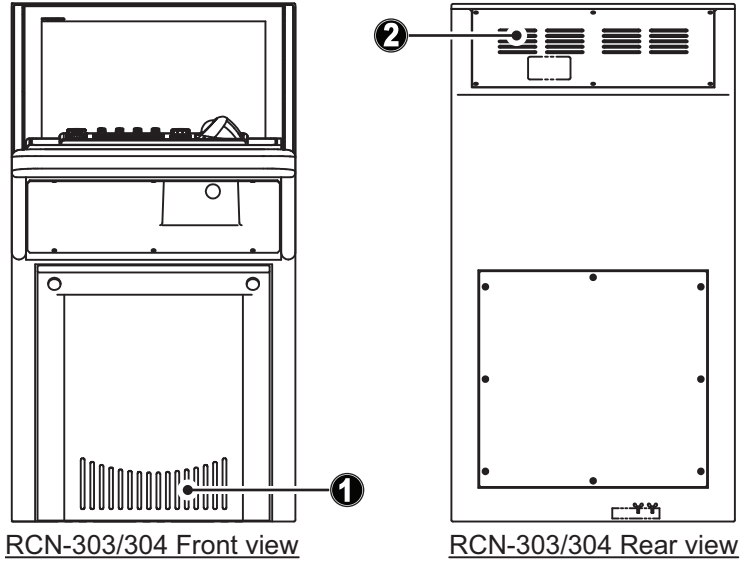

It is recommended to have a qualified technician clean and check the air filters when conducting routine service and maintenance. If the air filters require replacement, consult your dealer and quote the following details:

No.	Filter part no.	Filter Code no.	Remarks
1	03-163-7018	100-316-691-10	RCN-303/304: Front cover, lower section.
2	03-163-7219	100-320-810-10	RCN-303/304: Rear cover, upper section.

25.5 Troubleshooting

The troubleshooting table below provides common faults and the remedy with which to restore normal operation.

Radar troubleshooting

If...	then...	Remedy
the radar echoes disappear and the alert 727 (ALF format: 194,8) "Radar Sensor COM Error" appears	check the connection between the EC-3000 and radar sensor.	Reconnect the cable (if loosened) then restart the equipment.
the alert 750 (ALF format: 10740,3) "EXT Radar COM Error" appears	<ul style="list-style-type: none"> • check the connection between the EC-3000 of this equipment and the EC-3000 in the LAN line. • check the connection between the EC-3000 and radar sensor in the LAN line. 	Reconnect the cable (if loosened) then restart the equipment.
the equipment cannot be turned on	<ul style="list-style-type: none"> • power connector may have loosened. • ship's mains is off. • fuse has blown. 	<ul style="list-style-type: none"> • Check connector. • Check ship's mains. • Replace fuse.
the equipment can be turned on but nothing appears on the display	<ul style="list-style-type: none"> • brilliance is too low. • the ambient temperature is less than 0°C (32°F). 	<ul style="list-style-type: none"> • Adjust brilliance. • The heater is warming the EC-3000. The display appears in approx. 10 minutes.
key doesn't beep when operated	<ul style="list-style-type: none"> • key beep is turned off. 	<ul style="list-style-type: none"> • Turn on key beep from the menu.
picture not updated or picture freezes.	<ul style="list-style-type: none"> • If the picture freezes, the buzzer sounds and the Status LED blinks in red. 	<ul style="list-style-type: none"> • Restart the equipment.
picture does not change even though range is changed.	<ul style="list-style-type: none"> • suspect faulty the RANGE key or video freeze. 	<ul style="list-style-type: none"> • Hit the RANGE key several times. If nothing happens, restart the equipment.
only two index lines are displayed	<ul style="list-style-type: none"> • check index line distance setting. 	<ul style="list-style-type: none"> • Refer to section 2.23.3 for how to adjust index line distance.
range rings are not displayed	<ul style="list-style-type: none"> • range rings are hid. 	<ul style="list-style-type: none"> • Turn on the range rings.
tracked target is not tracked correctly	<ul style="list-style-type: none"> • sea clutter etc. are masking tracked target. 	<ul style="list-style-type: none"> • Adjust A/C SEA and A/C RAIN to suppress sea and rain clutters.
sensitivity is poor	<ul style="list-style-type: none"> • suspect second-trace echo or soiled radiator. 	<ul style="list-style-type: none"> • Reject second-trace echo; clean radiator.

Chart troubleshooting

If...	then...	Remedy
message "No connection to dongle" appears	<ul style="list-style-type: none"> • dongle is not connected. 	<ul style="list-style-type: none"> • Connect dongle.
the message "There is no dongle or an error has occurred in the dongle. The system will automatically shut down." appears	<ul style="list-style-type: none"> • dongle is not connected. • data in the dongle is corrupted. 	<ul style="list-style-type: none"> • Connect dongle. • Contact FURUNO for assistance.
monitored route is not displayed	<ul style="list-style-type: none"> • route has not been selected. • monitor route has not been selected to be visible above the chart. 	<ul style="list-style-type: none"> • Select route to monitor. • Open the [Route] page of the [Symbol Display] menu and check the monitored route parts to show.
planned route is not displayed	<ul style="list-style-type: none"> • route has not been selected. • planned route has not been selected to be visible above the chart. 	<ul style="list-style-type: none"> • Select route as "planned". • Open [Route] page of [Symbol Display] menu and check the planned route parts to show.
route monitoring is stopped	<ul style="list-style-type: none"> • Alert 691 (ALF format: 10800,1): RM Stop - Exceed Max XTE. Own ship is too far away from the route. • Alert 692 (ALF format: 10800,2): RM Stop - No Valid Sensor Data. Chart radar internal error. • Alert 693 (ALF format: 10800,3): RM Stop - Other Causes. Required data (position, SOG/COG) not found. 	<ul style="list-style-type: none"> • Steer the ship back to the route then restart route monitoring. • Request service. • Check sensor connections.
symbol of user chart cannot be erased	<ul style="list-style-type: none"> • two or more symbols may be superimposed on each other. 	<ul style="list-style-type: none"> • Do the delete action several times.
position cannot be found	<ul style="list-style-type: none"> • position sensor(s) is not selected on the [POSN] page. • position sensor is turned off. • sensor cable has loosened. 	<ul style="list-style-type: none"> • Check position sensor selections. • Turn on position sensor. • Check cable.
ENC chart cannot be displayed	<ul style="list-style-type: none"> • No ENC chart for area. • Dongle not connected. 	<ul style="list-style-type: none"> • Open ENC chart from [Manage Charts] dialog box • Connect dongle.
past track is not displayed	<ul style="list-style-type: none"> • past track is not selected to be visible. 	<ul style="list-style-type: none"> • Open [Tracking] page of [Symbol Display] menu and select [Own Ship Past Tracks] to [Primary] or [Secondary] as appropriate.
monitored user chart is not displayed on chart display	<ul style="list-style-type: none"> • user chart is not selected to be visible. 	<ul style="list-style-type: none"> • Open [Mariner] page of [Symbol Display] menu and select parts to show.
user chart is not displayed on radar display	<ul style="list-style-type: none"> • user chart is not selected in Voyage navigation mode. 	<ul style="list-style-type: none"> • Select user chart in Voyage navigation mode.
the message "Nearing memory usage limit. Click the Restart button to restart the system to prevent trouble." appears	<ul style="list-style-type: none"> • the memory usage limit for software is close to capacity. Performance may be affected. 	<p>If you need to save your work, click the [Later] button then restart the equipment. If you don't need to save your work, click the [Restart] button.</p>

If...	then...	Remedy
the message "Memory usage limit reached. Click the Restart button to restart the system to prevent trouble." appears	<ul style="list-style-type: none"> the memory usage limit for software is reached. Performance may be affected. 	Click the [Restart] button to reset the power. No other operations are available than restart.
both the display mode buttons [RADAR] and [CHART for RADAR] are yellow	<ul style="list-style-type: none"> the memory usage limit for software is close to capacity. Performance may be affected. 	Stop all operations and restart the equipment.

25.6 Consumable Parts

The table below lists the consumable parts in the antenna unit, Monitor Units, Processor Unit and Sensor Adapters. Request a FURUNO agent or dealer to replace the consumable parts, to get the best performance and longest possible life from the equipment.

Note: The expected lifetimes are typical values. Actual lifetime depends on usage and ambient temperature.

Consumable parts

Part	Type	Lifetime	Remarks
Antenna Unit			
Magnetron	FNE1201	5,000 hours	Check number of hours used at TX time. Reset time then adjust the PM gain after replacement (see section 2.32).
	MG5436	5,000 hours	
	MG5223F	7,000 hours	
Motor	BV2-K155	10,000 hours	For S-band radar
	BV2-K156	10,000 hours	For X-band radar
Monitor Unit			
BEZEL& LCD ASSEMBLY	Refer to the Operator's Manual for the Monitor Unit.		
Processor Unit EC-3000			
CPU Fan	KTA-555-01	8.5 years	
Power Fan	109P0612H761	8.5 years	
Chassis Fan	109P0612H761	8.5 years	
Sensor Adapter MC-3000S			
MC-CS Board	24P0114	8.5 years	
Sensor Adapter MC-3010A			
MC-ANLG Board	24P0115	7.0 years	

25.7 Color Differentiation Test for S57 Charts

The color differentiation checks if the chart radar monitor can distinguish between the various color-coded areas, lines and symbols.

1. Click the [Chart INFO] and [Chart 1] buttons on the InstantAccess bar™ to show the [ECDIS Chart 1] menu.

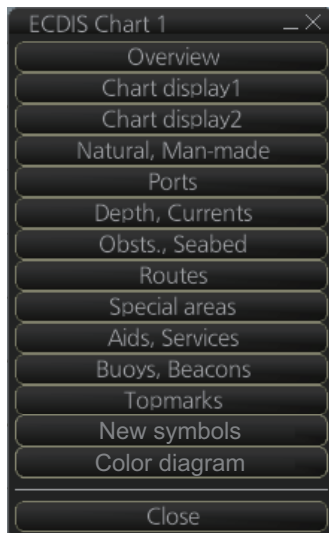

2. Click [Color diagram] to show the color test diagram.

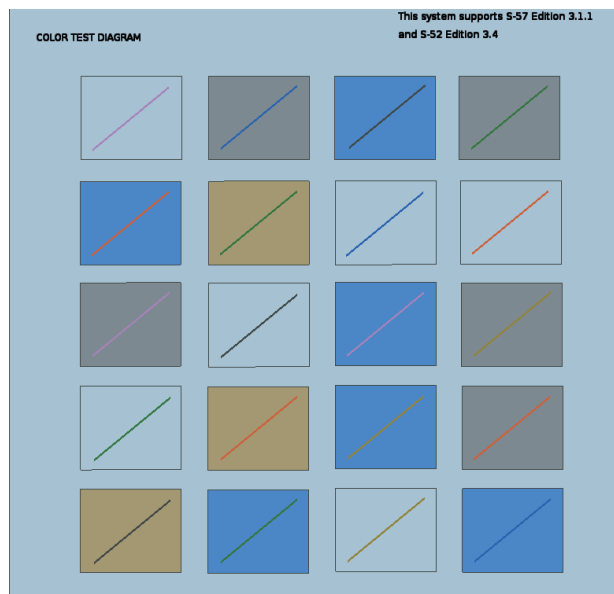

If the colors are correct, the diagonal line will be distinguishable from its surroundings, at any brilliance setting.

25.8 Fallback Arrangements

If the top priority sensor (e.g. GPS1) can not be used, this equipment automatically uses the second priority sensor (e.g. GPS2) when the multiple sensors (e.g. GPS1 and GPS2) are installed. When all sensors can not be used, each function is limited as follows:

Sensor	Operation of this equipment
Heading sensor	<ul style="list-style-type: none"> The HDG indication reads "****.*°". The presentation mode is automatically set for head-up. TT, AIS, radar map, chart and echo averaging (EAV) are disabled.
Speed sensor	<u>When LOG(WT) is selected:</u> <ul style="list-style-type: none"> The sensor used is automatically switched in the following priority order: GPS(BT) > LOG(BT). The SPD indication reads "****.* kn" when both GPS(BT) and LOG(BT) can not be used.
	<u>When LOG(BT) is selected:</u> <ul style="list-style-type: none"> The sensor used is automatically switched in the following priority order: GPS(BT) > LOG(WT). The SPD indication reads "****.* kn" when both GPS(BT) and LOG(WT) can not be used.
	<u>When GPS(BT) is selected:</u> <ul style="list-style-type: none"> The sensor used is automatically switched in the following priority order: LOG(BT) > LOG(WT). The SPD indication reads "****.* kn" when both LOG(BT) and LOG(WT) can not be used.
COG/SOG sensor	<ul style="list-style-type: none"> When the GPS sensor can not be used, the values of COG and SOG are calculated from HDG and LOG(BT). Additionally when the heading sensor can not be used, the values of SOG is calculated from LOG(BT). The COG indication reads "****.*°".
Position sensor	<ul style="list-style-type: none"> The POSN indication reads all asterisks. AIS, radar map and chart are disabled.

This page is intentionally left blank.

APPENDIX 1 MENU TREE

Radar menu

MENU key (press)
or
MENU bar (click)

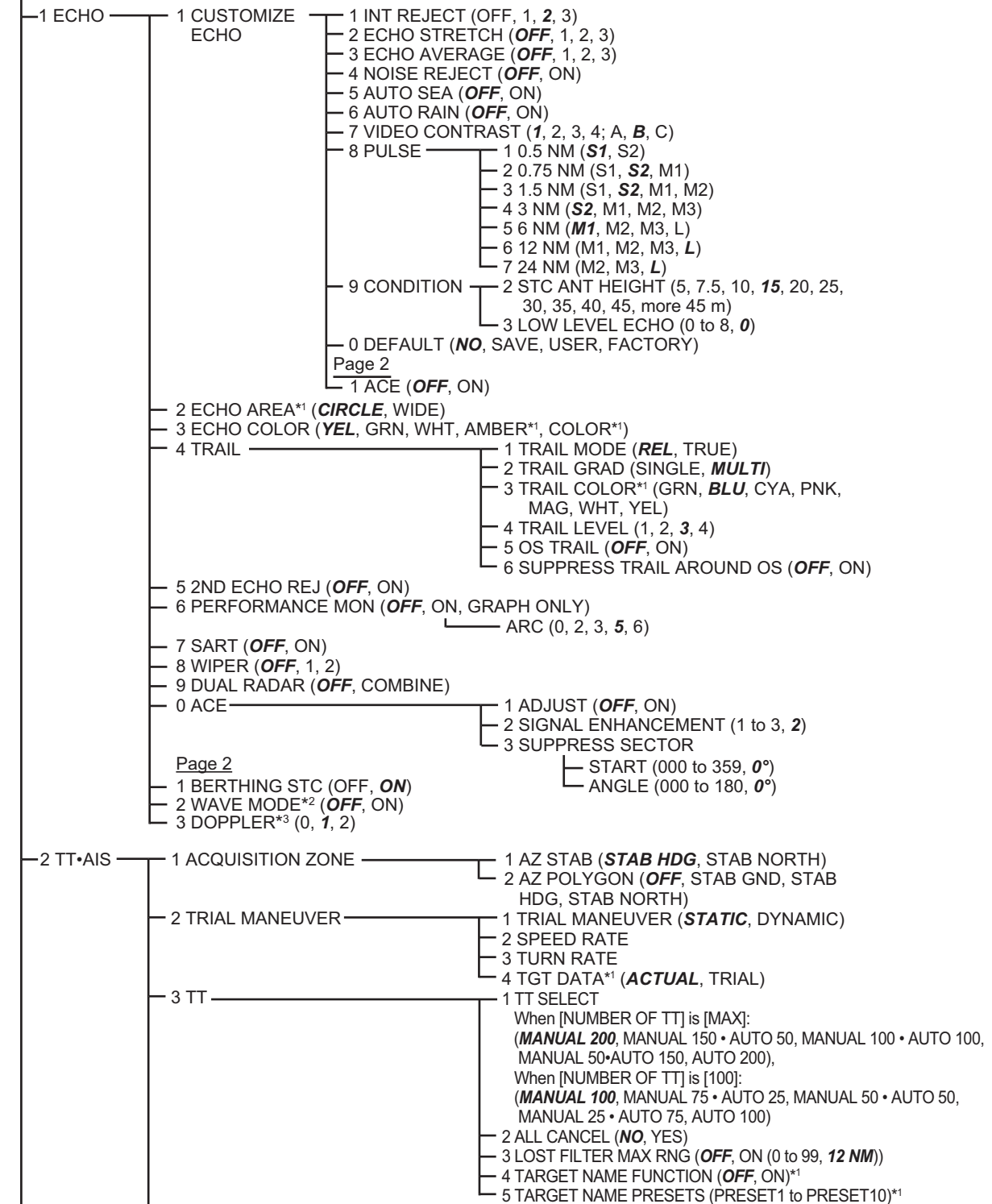

①

②

(Continued on next page)

*1: Not available for IMO/A-type radars.

*2: Requires connection to Wave Analysis PC.

*3: Available only for FAR-3220-NXT(-BB) and FAR-3230-NXT.

APPENDIX 1 MENU TREE

(Continued from previous page)

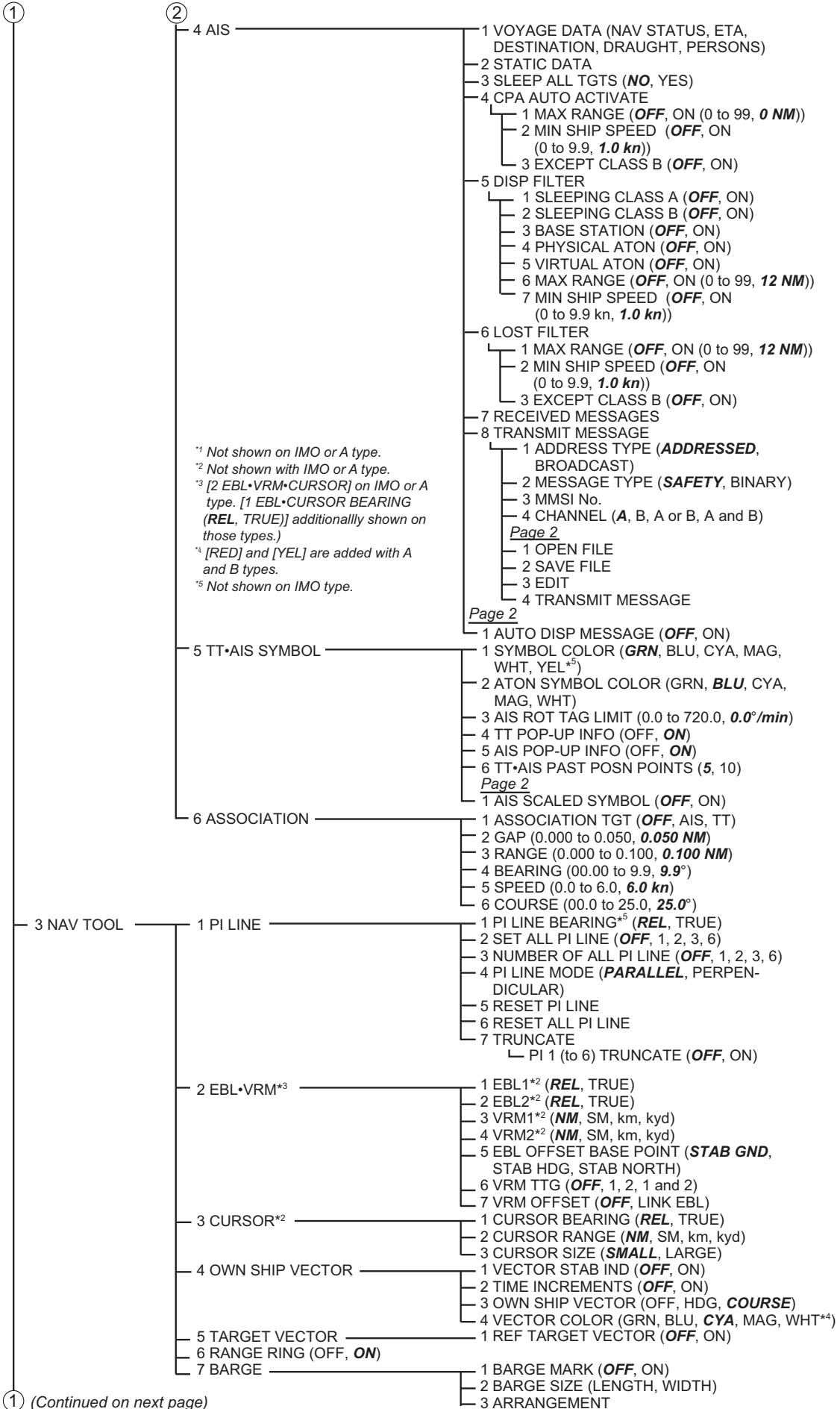

① (Continued from previous page)

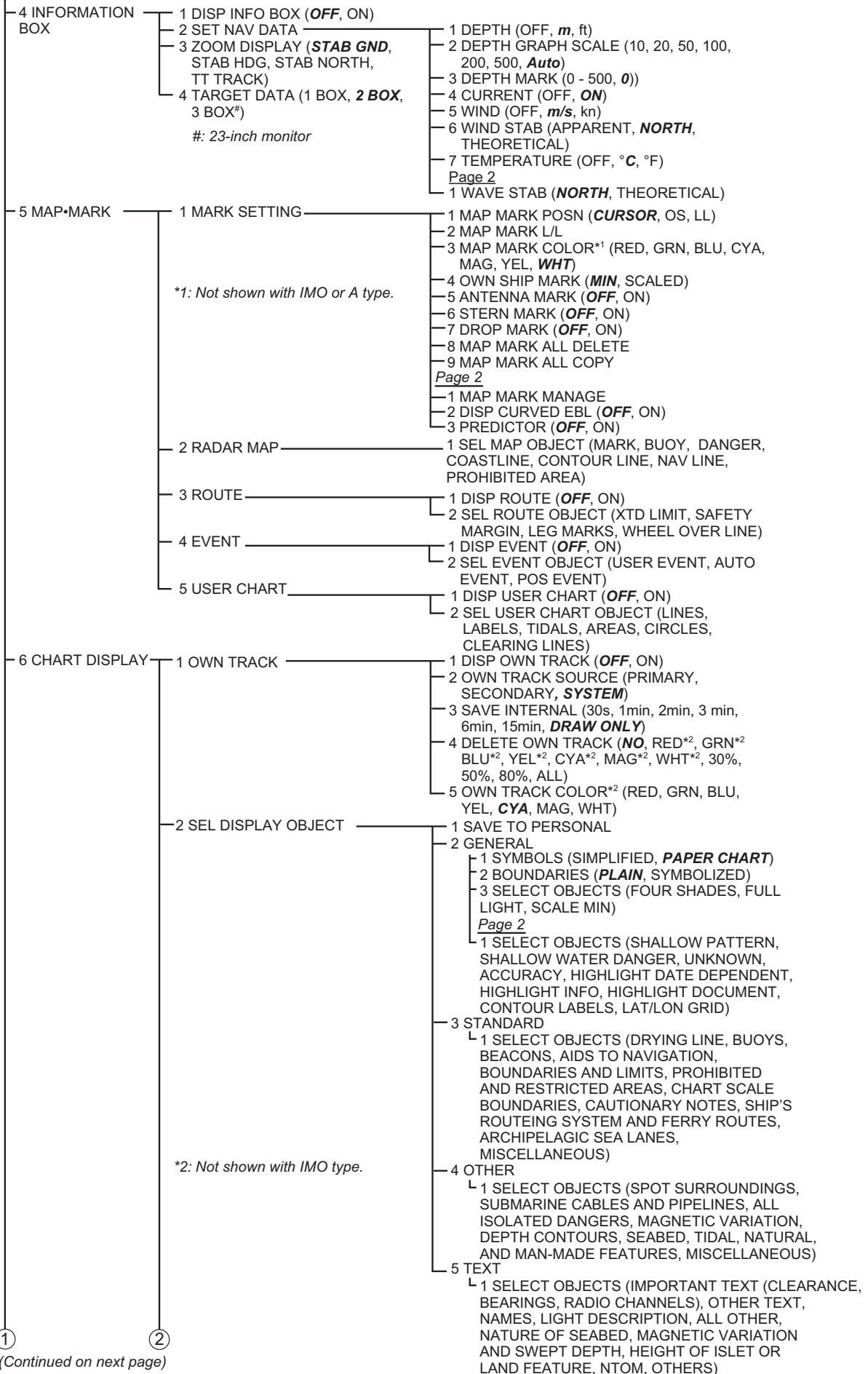

① (Continued on next page) ②

APPENDIX 1 MENU TREE

(Continued from previous page)

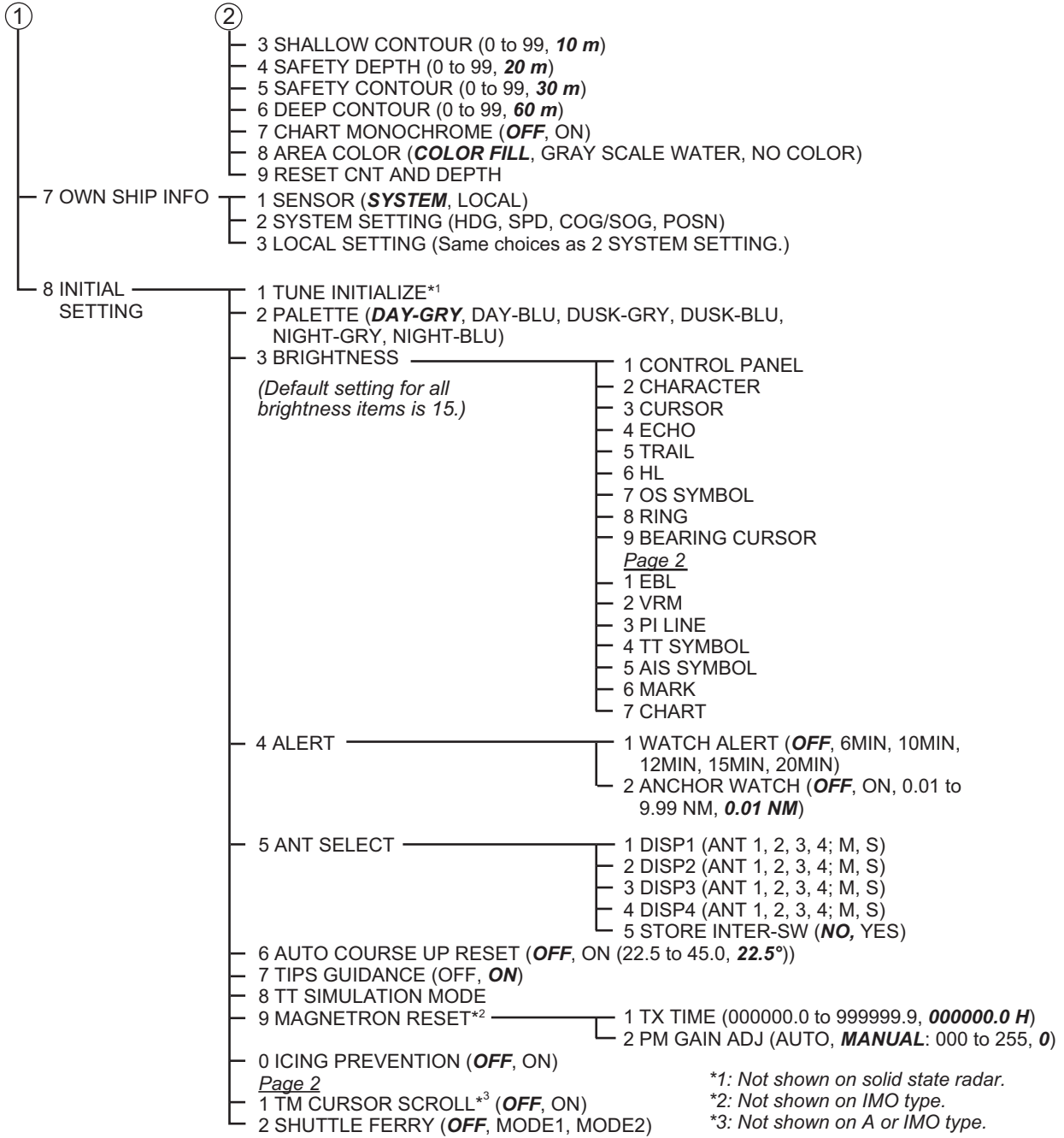
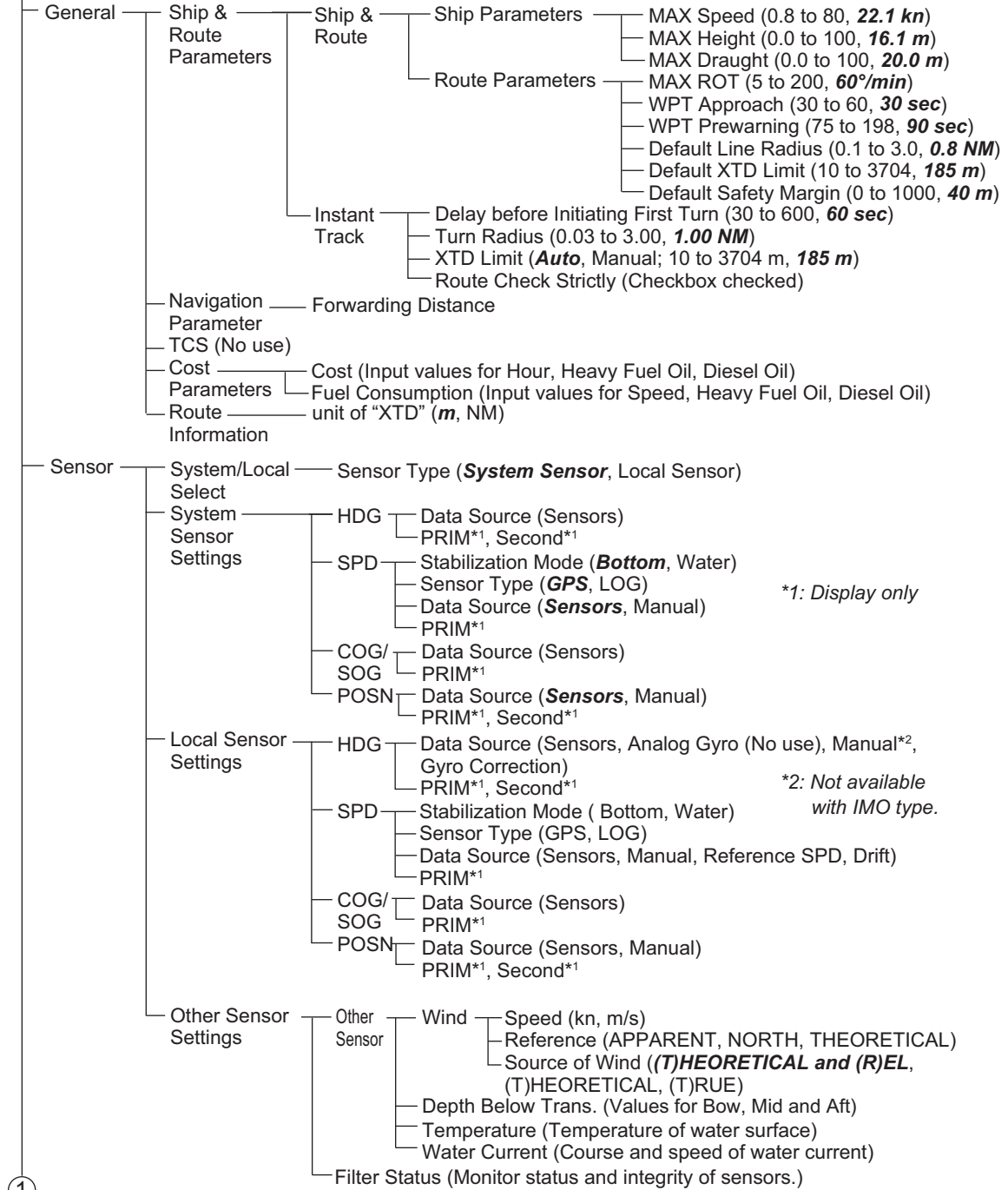
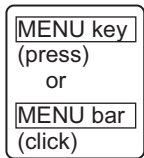

Chart menu



①
(Continued on next page)

APPENDIX 1 MENU TREE

(Continued from previous page)

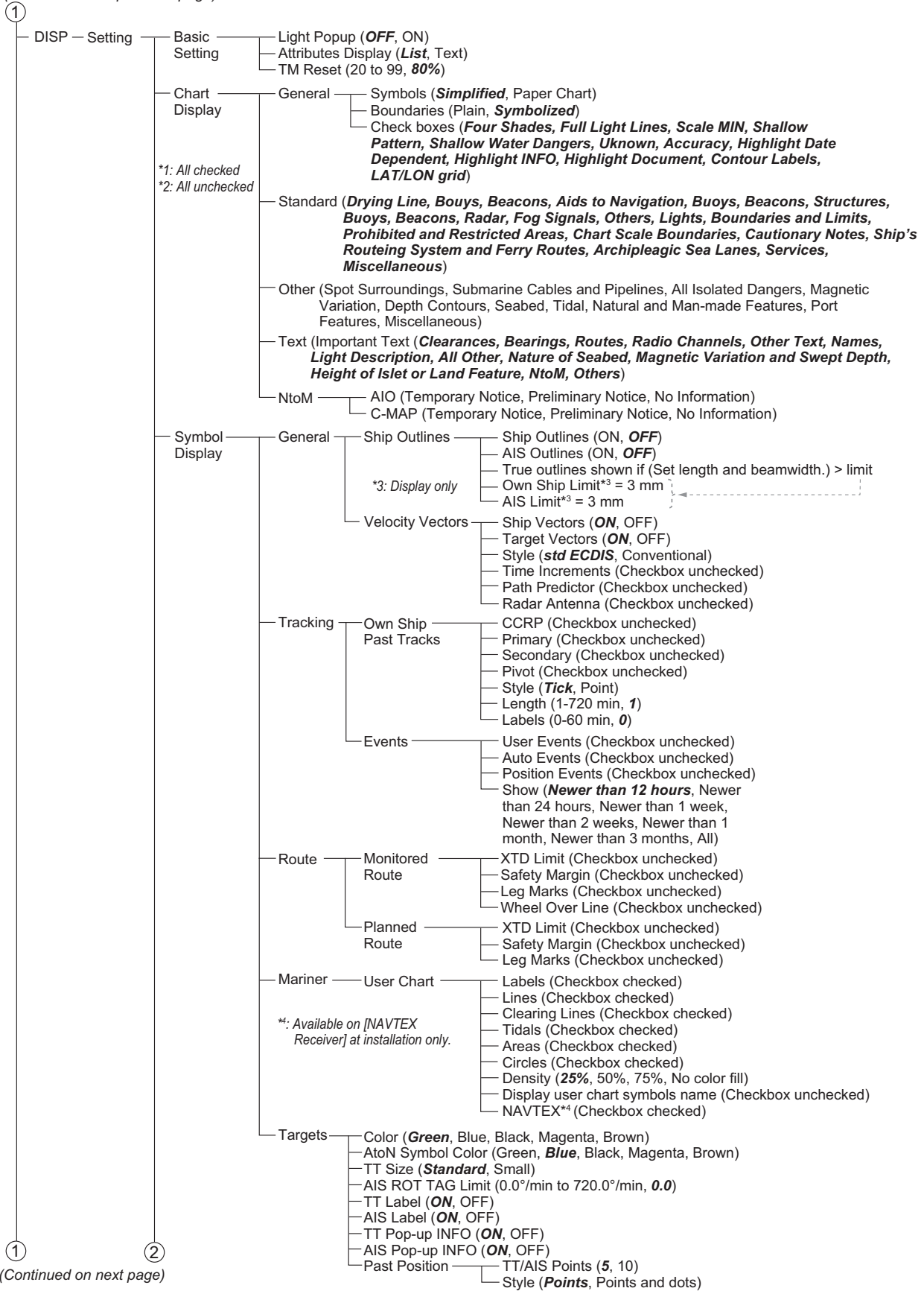

*1: All checked
*2: All unchecked

*3: Display only

*4: Available on [NAVTEX Receiver] at installation only.

① (Continued on next page) ②

(Continued from previous page)

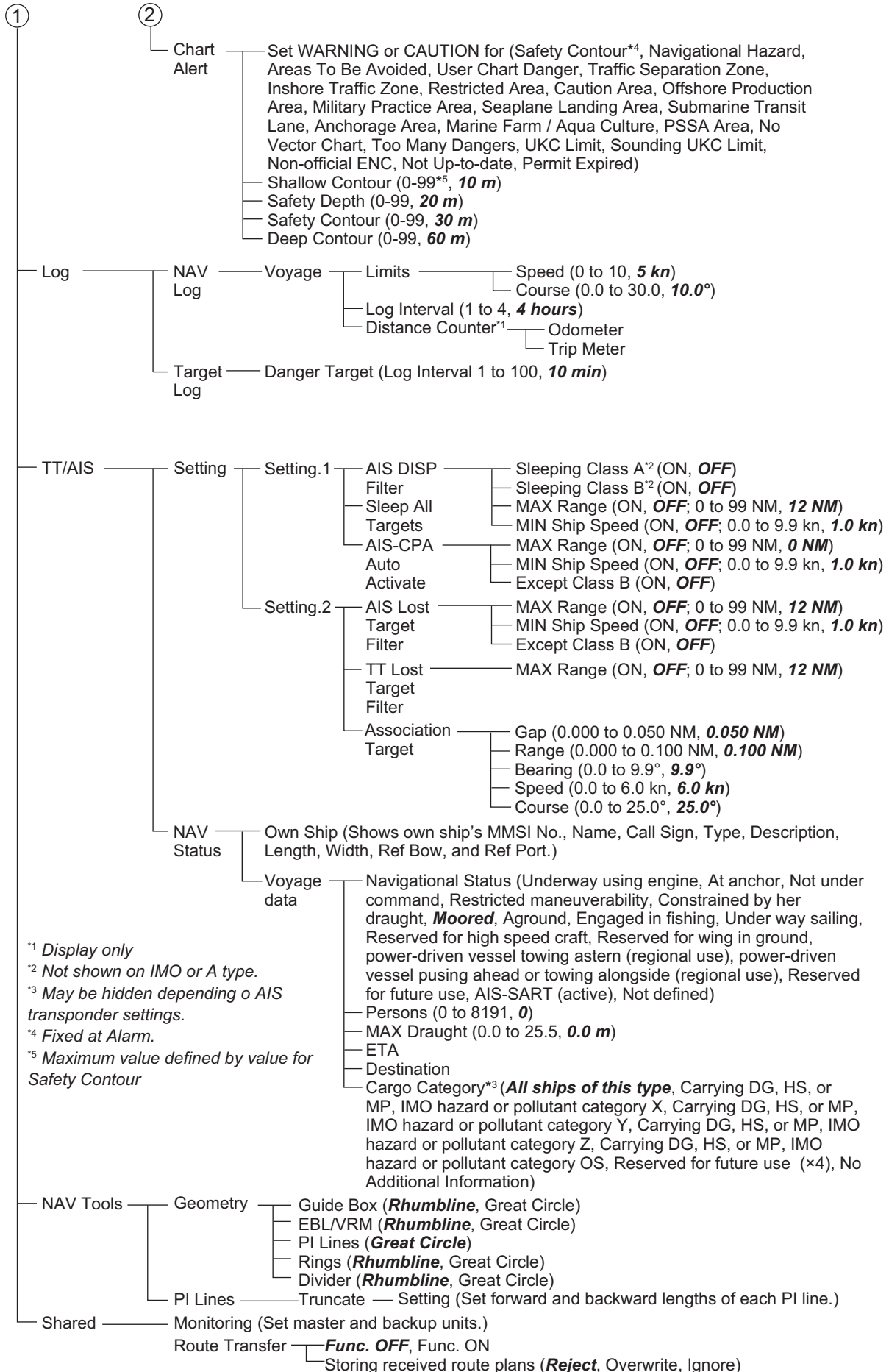

*¹ Display only

*² Not shown on IMO or A type.

*³ May be hidden depending on AIS transponder settings.

*⁴ Fixed at Alarm.

*⁵ Maximum value defined by value for Safety Contour

Settings menu

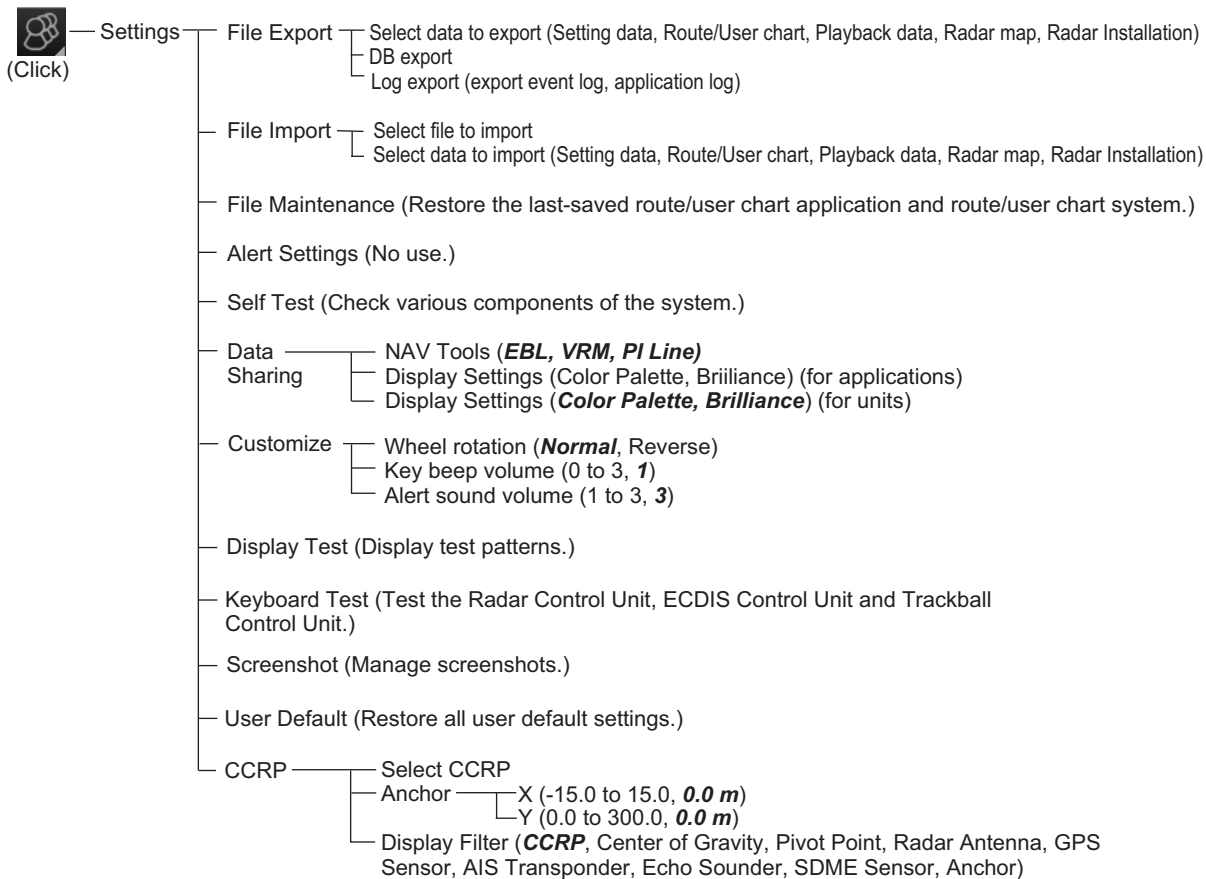

APPENDIX 2 ABBREVIATIONS AND SYMBOLS

Abbreviations

Abbreviation	Meaning
A/C	Anti Clutter
ACE	Automatic Clutter Elimination
ACK	Acknowledge
ACQ	Acquire
ACT	Activate
ADJ	Adjustment
AIO	Admiralty Information Overlay
AIS	Automatic Identification System
ALL	All
ALARM	Alarm
ANT	Antenna
Apr	April
ATON	Aid To Navigation
Aug	August
AUTO	Automatic
BB	Blackbox
BCR	Bow Cross Range
BCT	Bow Cross Time
BLU	Blue
BNWAS	Bridge Navigational Watch Alarm System
BRG	Bearing
BRILL	Brilliance
BT	Bottom Tracking
CANCEL	Cancel
Caps	Capital (letters)
CAT	Category
CCRP	Common Consistent Reference Position
CH	Channel
COG	Course over the ground
COM	Communication
CORRE	Correlation
CPA	Closest Point of Approach
CPU	Central Processing Unit
CSE	Course
CU/TM	Course-up/True Motion
CYA	CYAN
DATA	Data
Dec	December
DEMO	Demonstration
DGPS	Differential Global Positioning System
DISP	Display

APPENDIX 2 ABBREVIATIONS AND SYMBOLS

Abbreviation	Meaning
DIST	Distance
DR	Dead Reckoning
E	English
E	East
EAV	Echo Average
EBL	Electronic Bearing Line
ENTER	Enter
EPFS	Electronic Position Fixing System
ES	Echo Stretch
ESC	Escape
ETA	Estimated Time of Arrival
EXT	External
Feb	February
FILT	Filter
GAIN	Gain
GPS	Global Positioning System
GRN	Green
GRY	Gray
GYRO	Gyrocompass
HDG	Heading
HIDE	Hide
HL	Heading Line
hr	hour
IMO	International Maritime Organization
IND	Indication
INS	Integrated Navigation System
IR	Interference Rejection
J	Japanese
Jan	January
Jul	July
Jun	June
kyd	kiloyard
L	Long (pulse length), Local
L/L	Latitude/Longitude
LAN	Local Area Network
LIST	List
LL	Latitude, Longitude
LO	Low
MAG	Magenta, Magnetic, or Magnify
MAN	Manual
Mar	March
MARK	Mark
MAX	Maximum
MENU	Menu
MID	Middle
min	minute
MIN	Minimum
MMSI	Maritime Mobile Service Identity
MOB	Man Overboard



Abbreviation	Meaning
MODE	Mode
MON	Monitor
MSG	Message
NAV	Navigation
Navtex	Navigational Telex
NM	Nautical miles
NO.	Number
N	North
Nov	November
NtoM	Notices to Mariners
Oct	October
OFF	Off
OFFSET	Offset
OS	Own Ship
OWN	Own
PALETTE	Palette
PANEL	Panel Illumination
PC	Personal Computer
PERPENDIC	Perpendicular
PI	Parallel Index (lines)
POSN	Position
PRIM	Primary
PSSA	Particularly Sensitive Sea Area
PULSE	Pulse
R	Relative
RAD	Radius
RAIN	Rain
RANGE	Range
REF	Reference
Rel	Relative
RM	Relative Motion
RNG	Range
ROT	Rate of Turn
S	South, System
s	second
S1 (2)	Short1(2) (pulse length)
SAR	Search And Rescue
SART	Search And Rescue Transponder
SDME	Speed and Distance Measuring Equipment
SEA	Sea
SEL	Select
Sep	September
SM	Statute Miles
SOG	Speed Over the Ground
SPD	Speed
SPEC	Specification
SSD	Solid State Drive, Solid State Device
S.SRC	Sensor Source
STAB	Stabilization

APPENDIX 2 ABBREVIATIONS AND SYMBOLS





Abbreviation	Meaning
STBY	Stand-by
STD	Standard
SW	Switch
T	True
TARGET	Target
TB	True Bearing
TCPA	Time to Closest Point of Approach
TEMP	Temperature
TGT	Target
TGT, TGTS	Target, Targets
TIME	Time
TM	True Motion
TRAIL	Trail
True-G	True-ground
True-S	True-sea
TT	Tracked Target or Target Tracking
TTD	Tracked Target Data
TTG	Time to go
TTM	Tracked Target Information
TUNE	Tune
TX	Transmit
UKC	Under Keel Clearance
UNDO	Undo
UTC	Universal Time, Coordinated
VECT	Vector
VECTOR	Vector
VIEW	View
VRM	Variable Range Marker
W	West
W/O	Without
WHT	White
WOL	Wheel Over Line
WOP	Wheel Over Point
WPT	Waypoint
WT	Water Tracking
XTD	Cross Track Distance
YEL	Yellow







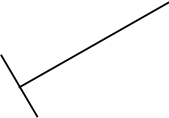

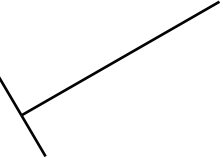
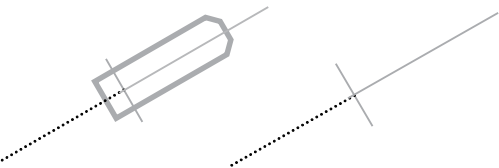
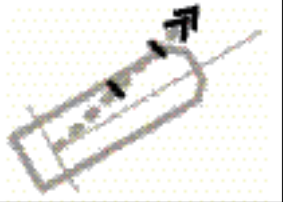
Symbols

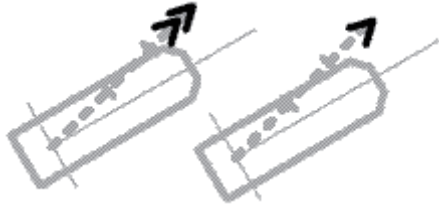
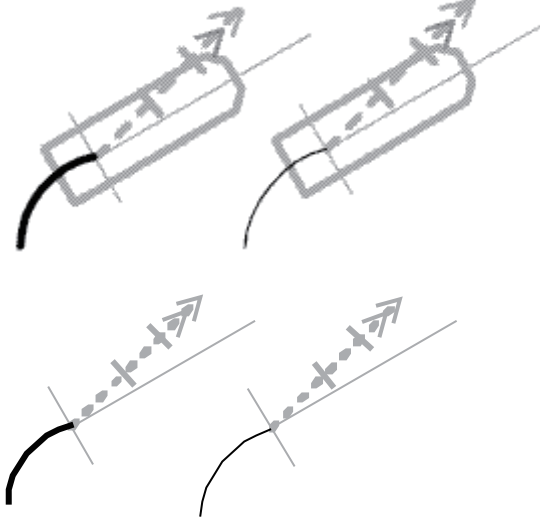











Symbols on Control Unit



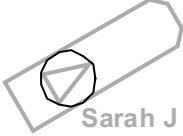

Symbol	Name
	Power switch
	Gain





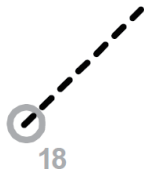
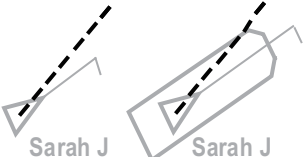

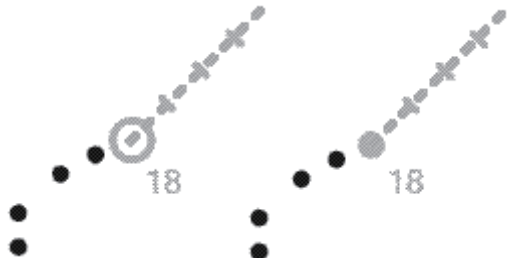

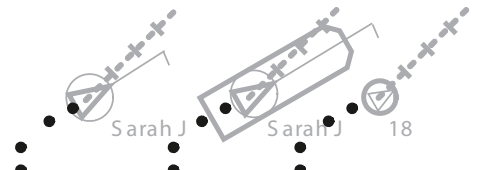
Symbols on display

Symbol name and description	Symbol graphic(s)
<p>Own ship - true scaled outline This can be displayed when based on user selection either beam width or length is more than 3 mm.</p>	
<p>Own ship - simplified symbol</p>	
<p>Own ship - minimized symbol</p>	
<p>Radar antenna position This symbol indicates location of the radar antenna. Select if position of radar antenna is displayed with symbol + in [MARK SETTING] menu.</p>	
<p>Own ship heading line This line originates from CCRP or Radar antenna position. CCRP: Consistent Common Reference Point</p>	
<p>Beam line This line passes through the CCRP or radar antenna position.</p>	
<p>Stern line</p>	
<p>Velocity vector - time increments</p>	





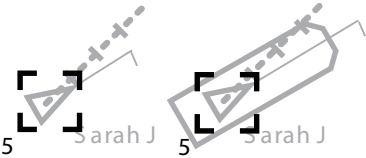
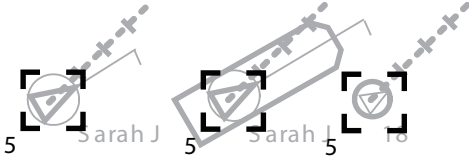







Symbol name and description	Symbol graphic(s)
<p>Velocity vector - stabilization indicator Ground stabilization is indicated by double arrow-head and water stabilization is indicated as single arrowhead.</p>	
<p>Past track System past track is indicated by thick line. Raw sensor primary past track is indicated by thin line. Raw sensor secondary past track is indicated by gray thin line.</p>	
<p>Radar targets in acquisition state</p>	 5 mm in diameter
<p>Radar targets in acquisition state - automatically detected Automatically detected target symbol is red and it flashes until acknowledged.</p>	 5 mm in diameter
<p>Tracked radar targets</p>	 3 mm in diameter
<p>Tracked radar targets - dangerous targets Dangerous target symbol is red and it flashes until acknowledged.</p>	
<p>Reference targets TT: Std or small user selection by Symbol Display.</p>	
<p>Sleeping AIS targets Orientation is towards heading (or COG if heading unknown). If both heading and COG are unknown the orientation is toward top of display.</p>	 Sleeping AIS target with neither reported heading nor COG 



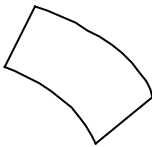

Symbol name and description	Symbol graphic(s)
<p>Activated AIS targets Orientation is towards heading (or COG if heading unknown).</p> <p>If both heading and COG are unknown the orientation is toward top of display.</p>	 <p>Sarah J</p> <p>Activated AIS target with neither reported heading nor COG</p>  <p>Sarah J</p>  <p>Sarah J</p>
<p>Activated AIS targets - true scaled outlines</p> <ul style="list-style-type: none"> This can be displayed when based on user selection either beam width or length is more than 3 mm. AIS outline: ON/OFF 	 <p>Sarah J</p>
<p>Activated AIS targets - dangerous targets Dangerous target symbol is red and it flashes until acknowledged.</p>	 <p>Sarah J</p>  <p>Sarah J</p> <p>Activated AIS target with neither reported heading nor COG</p>  <p>Sarah J</p>  <p>Sarah J</p>
<p>Activated AIS targets - alternative</p>	<p>Associated targets represented by AIS target symbols</p>  <p>Sarah J</p>  <p>Sarah J</p> <p>Associated targets represented by radar target symbols</p>  <p>18</p>
<p>Activated AIS targets - heading lines</p>	 <p>Sarah J</p>  <p>Sarah J</p>

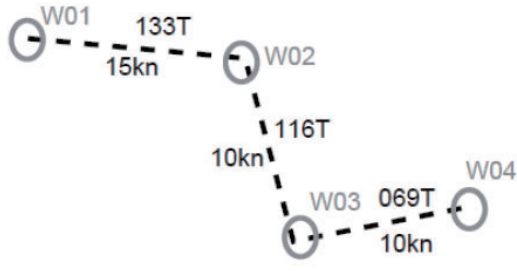
Symbol name and description	Symbol graphic(s)
<p>Activated AIS targets - heading lines - turn indicators</p>	
<p>Velocity vectors</p>	<p>Radar target velocity vectors</p>  <p>AIS target velocity vectors</p>  <p>Associated target velocity vectors</p> 
<p>Target past positions</p>	<p>Radar target past positions</p>  <p>AIS target past positions</p>  <p>Associated target past positions</p> 

Symbol name and description	Symbol graphic(s)
<p>AIS aid to navigation (ATON) Physical (real) ATON is solid line and virtual ATON is dashed line. An ATON in off position is yellow.</p>	
<p>AIS search and rescue transmitter -SART</p>	
<p>AIS base station</p>	
<p>AIS SAR vessel</p>	
<p>AIS aircraft</p>	
<p>Selected targets</p>	<p>Selected radar targets</p>  <p>Selected AIS targets</p>  <p>Selected association targets</p>  <p>Selected AIS ATON</p>  <p>Selected AIS SART</p> 

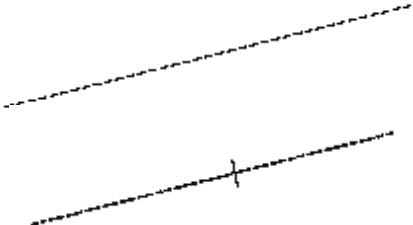
APPENDIX 2 ABBREVIATIONS AND SYMBOLS

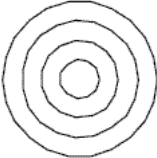
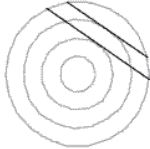
Symbol name and description	Symbol graphic(s)
<p>Lost targets Lost target symbol is red and it flashes until acknowledged.</p>	<p>Lost radar targets </p> <p>Lost AIS targets  </p> <p>Lost associated targets   </p> <p>LOST AIS ATON </p> <p>Lost AIS SART </p>
<p>Radar and AIS target acquisition area</p>	
<p>Waypoint</p>	
<p>Next waypoint</p>	
<p>Routes</p>	
<p>Event marker</p>	  MOB











Symbol name and description	Symbol graphic(s)
User cursor	
Electronic bearing line (EBL) Second example show with range marker.	
Variable range marker (VRM)	
Range rings	
Parallel index lines	
Trial maneuver Displayed (flashing) during trial maneuver.	T
Simulation mode Displayed (flashing) during TT performance test.	S
Drop mark	

Radar map symbols





IMO and A types				B-type			
Category	Symbol	Color*	Name	Category	Symbol	Color	Name
Mark		Red	Buoy	Mark		7 colors	Buoy
		Green	Buoy			7 colors	Buoy
		Red	Buoy			7 colors	Buoy
		Green	Buoy			7 colors	Buoy
		Red	Buoy			7 colors	Danger
		Green	Buoy			7 colors	Danger
		Red	Buoy			7 colors	Mark
		Green	Buoy			7 colors	Mark
		Magenta	Danger			7 colors	Mark
		Magenta	Danger			7 colors	Mark
		Yellow-Orange	Mark			7 colors	Mark
		Yellow-Orange	Mark			7 colors	Mark
		Yellow-Orange	Mark			7 colors	Mark
Line		Magenta	Nav Line	Line		7 colors	Mark
		White	Coast Line			7 colors	Mark
		Gray	Contour Line			7 colors	Nav Line
		Magenta	Prohibited Area			7 colors	Coast Line
		Magenta	Cable (Danger)			7 colors	Contour Line
		Yellow-Orange	Line Mark			7 colors	Prohibited Area
		Yellow-Orange	Line Mark			7 colors	Cable (Danger)
					7 colors	Line Buoy	
					7 colors	Line Mark	
					7 colors	Line Mark	
					7 colors	Line Mark	

*Fixed

Symbols on operating buttons

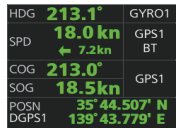
Symbol	Meaning
	Minimize button (on InstantAccess bar™)
	Access AIS, Navtex functions (chart mode)
	Display received AIS message (radar mode)
	Access user profile, common settings
	Information (show program no., operator's manual)
	Undo, redo Note: This symbol is not displayed on the FURUNO 19-inch monitor unit on radar mode or chart radar mode.
	Screenshot capture
 OR 	<ul style="list-style-type: none"> • Adjust the monitor brilliance • Adjust the control unit backlighting. (Chart mode only) The sharing method is shown as “S” (System) or “L” (Local).
 OR 	Color palette selection The sharing method is shown as “S” (System) or “L” (Local).

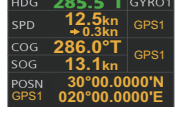
APPENDIX 3 DATA COLOR AND MEANING

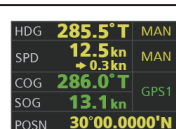
	Indication color	Sensor color	HDG	L/L	SPD	COG/SOG	Display example
SYSTEM/ LOCAL	GRN	WHT	THS-A HDT	GNS-A, D, F, P, R GGA-1, 2, 3, 4, 5 GLL-A, D and (status: A) RMC-A, D, F, P, R and (status: A) *1	VBW-A VHW	VTG-A,D,P RMC-A, D, F, P, R and (status: A) *1	 All values in green.
	YEL	WHT		DGPS update interval in GGA, GNS sentence is higher than 10 seconds. GNS-A, D, F, P, R RMC-A, D, F, P, R and (status: A) *2		RMC-A,D, F, P, R and (status: A) *2	 Position in yellow characters.
	YEL-ORG	WHT		GNS-E,M,S GGA-6,7,8 GLL-E,M,S and (status: A) RMC-E,M,S and (status: A)	VBW (SOG: without either of Field 4 or 5)	VTG-E,M,S RMC-E,M,S and (status: A)	 SPD, COG, SOG and POSN values and pos. source name in yellow-orange.
	GRN (***)	WHT	THS-E, M, S: Invalid HDT: Invalid No sentences	GNS-N: Invalid GGA-0: Invalid GLL-N or (status: V): Invalid RMC-N or (status: V): Invalid No sentences	VBW-V: Invalid VHW: Invalid No sentences	VTG-N: Invalid RMC-N or (status: V): Invalid No sentences	 HDG value shown with asterisks.
	GRN	YEL (DR)		Internally calculated due to loss of communication with sensor. (Dead Reckoning)			 Position in green characters, DR in yellow characters.
MANUAL	YEL	WHT (MAN) (DR)	Manual setting value (Type A or B) Correction setting value (Local setting)	Manual setting value (Dead Reckoning)	Manual setting value	 HDG, SPD and POSN values and "MAN" in yellow characters.	

*1: Navigational status in RMC, GNS sentence shown in "S", "V" only (IEC 61162-1 ed4 or later).

*2: Navigational status in RMC, GNS sentence shown in "C", "U", "null" only (IEC 61162-1 ed4 or later).

*3: "CORR1" replaces "MAN" in case of heading offset.

APPENDIX 4 ALERT LIST

The table below lists the possible alerts for this radar. Each alert is listed with priority, category and escalation. This radar can output alerts in ALF or ALR format. The alert number for each depends on the output format and may differ.

Note: The ALR format is not BAM-compliant and shall not be used for new installations. It may be used for retrofitting on ships-in-operation only.

The default escalation time is 60 seconds, with the exception of the following:

- Alert 495 (ALF format: 10802) Anchor Watch: (120 seconds)

Alerts which are not acknowledge within the set time limit are escalated to either Alarm level (**), or are repeated as a warning (*). If you require a different time limit or different level, consult your FURUNO dealer.

You can downgrade the priority for some alerts to [Warning] from the [Chart Alerts] page (see section 11.1.2).

Note: When this unit is assigned as a backup ECDIS, the following ALF alerts are output with the EI talker.(170 to 174,10173,10644,10700,10800 to 10803,10850,10860)

ALF	ALR	Alert Name, Meaning and Remedy	Priority/Category
170,-	170	Name: Positioning System Failure* Meaning: All position data has been lost for more than 30 seconds. Remedy: Check the connection with all GPS.	Warning/B
171,-	171	Name: Crossing Safety Contour Meaning: When a check area is set, the vessel entered a shallower area than the threshold set in [Safety Contour]. Remedy: Reconfirm Safety Contour setting or change the course.	Alarm/A
172,-	172	Name: Off Track Alarm Meaning: Deviation is big between planning course and current heading. While monitoring route, ship position deviates XTD Limit. Remedy: Reconfirm XTD Limit or keep own ship inside of channel limit.	Alarm/A
173,1	620	Name: User Chart Danger Area* Meaning: A User Chart Danger Area that is set to Warning/Caution in chart alert is detected inside the check area. Remedy: Be careful of the object mentioned, on ship's direction.	Warning/A
173,2	621	Name: Traffic Separation Zone* Meaning: A Traffic Separation Zone that is set to Warning/Caution in chart alert is detected inside the check area. Remedy: Be careful of the object mentioned, on ship's direction.	Warning/A
173,3	622	Name: Inshore Traffic Zone* Meaning: An Inshore Traffic Zone that is set to Warning/Caution in chart alert is detected inside the check area. Remedy: Be careful of the object mentioned, on ship's direction.	Warning/A
173,4	623	Name: Restricted Area* Meaning: A Restricted Area that is set to Warning/Caution in chart alert is detected inside the check area. Remedy: Be careful of the object mentioned, on ship's direction.	Warning/A

APPENDIX 4 ALERT LIST

ALF	ALR	Alert Name, Meaning and Remedy	Priority/Category
173,5	624	Name: Caution Area* Meaning: A Caution Area that is set to Warning/Caution in chart alert is detected inside the check area. Remedy: Be careful of the object mentioned, on ship's direction.	Warning/A
173,6	625	Name: Offshore Production Area* Meaning: An Offshore Production Area that is set to Warning/Caution in chart alert is detected inside the check area. Remedy: Be careful of the object mentioned, on ship's direction.	Warning/A
173,7	626	Name: Military Practice Area* Meaning: A Military Protection Area that is set to Warning/Caution in chart alert is detected inside the check area. Remedy: Be careful of the object mentioned, on ship's direction.	Warning/A
173,8	627	Name: Seaplane Landing Area* Meaning: A Seaplane Landing Area that is set to Warning/Caution in chart alert is detected inside the check area. Remedy: Be careful of the object mentioned, on ship's direction.	Warning/A
173,9	628	Name: Submarine Transit Lane* Meaning: A Submarine Transit Lane that is set to Warning/Caution in chart alert is detected inside the check area. Remedy: Be careful of the object mentioned, on ship's direction.	Warning/A
173,10	629	Name: Anchorage Area* Meaning: An Anchorage Area that is set to Warning/Caution in chart alert is detected inside the check area. Remedy: Be careful of the object mentioned, on ship's direction.	Warning/A
173,11	630	Name: Marine Farm/Aquaculture* Meaning: A Marine Farm/Aquaculture that is set to Warning/Caution in chart alert is detected inside the check area. Remedy: Be careful of the object mentioned, on ship's direction.	Warning/A
173,12	631	Name: PSSA Area* Meaning: A PSSA Area that is set to Warning/Caution in chart alert is detected inside the check area. Remedy: Be careful of the object mentioned, on ship's direction.	Warning/A
173,13	632	Name: Areas to be Avoided* Meaning: An Areas to be Avoided that is set to Alarm in chart alert is detected inside the check area. Remedy: Be careful of the object mentioned, on ship's direction.	Warning/A
174,-	174	Name: WPT Approach* Meaning: If this radar is connected in the network to an FMD- 3200/ 3300 ECDIS that is interfaced with an IEC 62065 Ed.2 compliant TCS (YOKOGAWA PT-900, Tokyo Keiki PR-9000, EMRI FAP-3000), this alert is generated at each waypoint if the TCS is not connected to the ECDIS in route monitoring. Check ECDIS and network connections. Remedy: Check ECDIS and network connections.	Warning/A
175,1	455	Name: EPFS1 Invalid/missing datum* Meaning: Ship position data from No.1 GPS has been discontinued for more than set time.(Set at installation) Default: 60 seconds No.1 GPS is turned off, or there is a problem with network. Remedy: Check the connection with No.1 GPS and network.	Warning/B

ALF	ALR	Alert Name, Meaning and Remedy	Priority/Category
175,2	456	Name: EPFS2 Invalid/missing datum* Meaning: Ship position data from No.2 GPS has been discontinued for more than set time.(Set at installation) Default: 60 seconds No.2 GPS is turned off, or there is a problem with network. Remedy: Check the connection with No.2 GPS and network.	Warning/B
175,3	457	Name: EPFS3 Invalid/missing datum* Meaning: Ship position data from No.3 GPS has been discontinued for more than set time. (Set at installation) Default: 60 seconds No.3 GPS is turned off, or there is a problem with network. Remedy: Check the connection with No.3 GPS and network.	Warning/B
175,4	458	Name: EPFS4 Invalid/missing datum* Meaning: Ship position data from No.4 GPS has been discontinued for more than set time. (Set at installation) Default: 60 seconds No.4 GPS is turned off, or there is a problem with network. Remedy: Check the connection with No.4 GPS and network.	Warning/B
175,5	459	Name: EPFS5 Invalid/missing datum* Meaning: Ship position data from No.5 GPS has been discontinued for more than set time. (Set at installation) Default: 60 seconds No.5 GPS is turned off, or there is a problem with network. Remedy: Check the connection with No.5 GPS and network.	Warning/B
175,6	460	Name: EPFS6 Invalid/missing datum* Meaning: Ship position data from No.6 GPS has been discontinued for more than set time. (Set at installation) Default: 60 seconds No.6 GPS is turned off, or there is a problem with network. Remedy: Check the connection with No.6 GPS and network.	Warning/B
175,7	461	Name: EPFS7 Invalid/missing datum* Meaning: Ship position data from No.7 GPS has been discontinued for more than set time. (Set at installation) Default: 60 seconds No.7 GPS is turned off, or there is a problem with network. Remedy: Check the connection with No.7 GPS and network.	Warning/B
175,8	462	Name: EPFS8 Invalid/missing datum* Meaning: Ship position data from No.8 GPS has been discontinued for more than set time. (Set at installation) Default: 60 seconds No.8 GPS is turned off, or there is a problem with network. Remedy: Check the connection with No.8 GPS and network.	Warning/B
175,9	463	Name: EPFS9 Invalid/missing datum* Meaning: Ship position data from No.9 GPS has been discontinued for more than set time. (Set at installation) Default: 60 seconds No.9 GPS is turned off, or there is a problem with network. Remedy: Check the connection with No.9 GPS and network.	Warning/B
175,10	464	Name: EPFS10 Invalid/missing datum* Meaning: Ship position data from No.10 GPS has been discontinued for more than set time. (Set at installation) Default: 60 seconds No.10 GPS is turned off, or there is a problem with network. Remedy: Check the connection with No.10 GPS and network.	Warning/B
190,1	531	Name: AIS Target Display 100%* Meaning: 100% of maximum number of target which can be displayed is used. Remedy: The number of AIS target became 100% of that can be displayed. Change the display number using filter function.	Warning/A

APPENDIX 4 ALERT LIST

ALF	ALR	Alert Name, Meaning and Remedy	Priority/Category
190,2	533	Name: AIS Target Capacity 100%* Meaning: 100% of memory capacity for AIS targets is filled. Remedy: Memory for AIS targets is filled 100%. Cancel unnecessary targets.	Warning/A
190,3	535	Name: AIS Target Activate 100%* Meaning: 100% of capacity for active AIS is used. Remedy: The number of active AIS target became 100% of its limit. Change the unnecessary targets to sleep mode.	Warning/A
190,4	523	Name: TT Auto ACQ 100%* Meaning: 100% of capacity for automatically acquired TT is used. Remedy: The number of acquired TT target became 100% of its limit. Stop tracking unnecessary TT targets.	Warning/A
190,5	525	Name: TT MAN ACQ 100%* Meaning: 100% of capacity for manually acquired TT is used. Remedy: The number of acquired TT target became 100% of its limit. Stop tracking unnecessary TT targets.	Warning/A
191,1	526	Name: TT CPA/TCPA* Meaning: The system has detected a dangerous TT target. Remedy: Check the target details, avoid collision.	Alarm/A
191,2	536	Name: AIS CPA/TCPA* Meaning: The system has detected a dangerous AIS target. Remedy: Check the target details, avoid collision.	Alarm/A
192,1	521	Name: TT New Target* Meaning: The system detected a new TT target. Remedy: Check the target details and take appropriate action.	Warning/A
192,2	529	Name: AIS New Target* Meaning: The system detected a new AIS target. Remedy: Check the target details and take appropriate action.	Warning/A
193,1	527	Name: TT Lost* Meaning: The system lost a TT target. Remedy: Confirm that the target is lost, then acknowledge the alert. If the target was used as a speed reference, acquire a new reference target.	Warning/A
193,2	528	Name: REF Target Lost* Meaning: The system lost a reference target. Remedy: Confirm that the target is lost, then acknowledge the alert. If the target was used as a speed reference, acquire a new reference target.	Warning/A
193,3	537	Name: AIS Lost* Meaning: The system lost an AIS target. Remedy: Confirm that the target is lost, then acknowledge the alert. If the target was used as a speed reference, acquire a new reference target.	Warning/A
194,1	720	Name: No ANT Heading Signal* Meaning: There is a problem with the heading signal from the radar antenna. Remedy: Check connections between the radar antenna and the processor unit. If the problem appears to be caused by the radar antenna, contact your local dealer for service.	Warning/B

ALF	ALR	Alert Name, Meaning and Remedy	Priority/Category
194,2	721	<p>Name: No ANT Azimuth Signal*</p> <p>Meaning: There is a problem with the azimuth signal from the radar antenna.</p> <p>Remedy: Check connections between the radar antenna and the processor unit. If the problem appears to be caused by the radar antenna, contact your local dealer for service.</p>	Warning/B
194,3	722	<p>Name: No ANT Trigger Signal*</p> <p>Meaning: There is a problem with the trigger signal from the radar antenna.</p> <p>Remedy: Check connections between the radar antenna and the processor unit. If the problem appears to be caused by the radar antenna, contact your local dealer for service.</p>	Warning/B
194,4	723	<p>Name: No ANT Video Signal*</p> <p>Meaning: There is a problem with the video signal from the radar antenna.</p> <p>Remedy: Check connections between the radar antenna and the processor unit. If the problem appears to be caused by the radar antenna, contact your local dealer for service.</p>	Warning/B
194,5	724	<p>Name: No RPU Gyro Signal*</p> <p>Meaning: There is a problem with the gyro signal from the radar antenna.</p> <p>Remedy: Check connections between the radar antenna and the processor unit. If the problem appears to be caused by the radar antenna, contact your local dealer for service.</p>	Warning/B
194,6	725	<p>Name: No ANT Echo Signal*</p> <p>Meaning: There is a problem with the echo signal from the radar antenna.</p> <p>Remedy: Check connections between the radar antenna and the processor unit. If the problem appears to be caused by the radar antenna, contact your local dealer for service.</p>	Warning/B
194,8	727	<p>Name: Radar Sensor COM Error*</p> <p>Meaning: There is a problem communicating with the SPU board in the radar antenna.</p> <p>Remedy: Check connections between the radar antenna and the processor unit. If the problem appears to be caused by the radar antenna, contact your local dealer for service.</p>	Warning/B
194,9	770	<p>Name: SPU Error*</p> <p>Meaning: There is a problem with the SPU board in the radar antenna.</p> <p>Remedy: For detailed information, conduct a [Self Test].</p>	Warning/B
194,10	771	<p>Name: MTR-DRV Error*</p> <p>Meaning: There is a problem communicating with the MTR-DRV board in the radar antenna.</p> <p>Remedy: For detailed information, conduct a [Self Test].</p>	Warning/B
194,11	772	<p>Name: PM Error*</p> <p>Meaning: There is a problem communicating with the PM board in the radar antenna.</p> <p>Remedy: For detailed information, conduct a [Self Test].</p>	Warning/B
194,12	773	<p>Name: RF-Converter Error*</p> <p>Meaning: There is a problem with the RF-Converter board in the radar antenna.</p> <p>Remedy: For detailed information, conduct a [Self Test].</p>	Warning/B

APPENDIX 4 ALERT LIST

ALF	ALR	Alert Name, Meaning and Remedy	Priority/Category
194,13	774	Name: PSU-Control Error* Meaning: There is a problem with the PSU-Control board in the power supply unit. Remedy: For detailed information, conduct a [Self Test].	Warning/B
194,14	781	Name: MTR-DRV COM Error* Meaning: There is a problem communicating with the SPU board in the radar antenna. Remedy: Check connections between the radar antenna and the processor unit. If the problem appears to be caused by the radar antenna, contact your local dealer for service.	Warning/B
194,15	782	Name: PM COM Error* Meaning: There is a problem communicating with the MTR-DRV board in the radar antenna. Remedy: Check connections between the radar antenna and the processor unit. If the problem appears to be caused by the radar antenna, contact your local dealer for service.	Caution/B
194,16	783	Name: RF-Converter COM Error* Meaning: There is a problem communicating with the RF-Converter board in the radar antenna. Remedy: Check connections between the radar antenna and the processor unit. If the problem appears to be caused by the radar antenna, contact your local dealer for service.	Warning/B
194,17	775	Name: HPA Error* Meaning: There is a problem with the HPA board in the radar antenna. Remedy: For detailed information, conduct a [Self Test].	Warning/B
194,18	784	Name: PSU-Control COM Error* Meaning: There is a problem communicating with PSU-Control board in the power supply unit. Remedy: For detailed information, conduct a [Self Test].	Warning/B
10001,1	001	Name: Main Monitor Fan1 Rotation Speed Lowering Meaning: For MU-190/231: Connected to COM1 (Main Monitor). Fan1 rotation speed is below threshold. Remedy: If the error frequently occurs, contact FURUNO and inform frequency of occurrence.	Caution/B
10001,2	002	Name: Main Monitor Fan2 Rotation Speed Lowering Meaning: For MU-231: Connected to COM1 (Main Monitor). Fan2 rotation speed is below threshold. Remedy: If the error frequently occurs, contact FURUNO and inform frequency of occurrence.	Caution/B
10001,3	003	Name: Main Monitor Fan3 Rotation Speed Lowering Meaning: For MU-231: Connected to COM1 (Main Monitor). Fan3 rotation speed is below threshold. Remedy: If the error frequently occurs, contact FURUNO and inform frequency of occurrence.	Caution/B
10001,4	004	Name: Main Monitor Fan4 Rotation Speed Lowering Meaning: For MU-190: Connected to COM1 (Main Monitor). Fan4 rotation speed is below threshold. Remedy: If the error frequently occurs, contact FURUNO and inform frequency of occurrence.	Caution/B

ALF	ALR	Alert Name, Meaning and Remedy	Priority/Category
10001,5	014	Name: Sub Monitor Fan1 Rotation Speed Lowering Meaning: For MU-190/231: Connected to COM2 (Sub Monitor). Fan1 rotation speed is below threshold. Remedy: If the error frequently occurs, contact FURUNO and inform frequency of occurrence.	Caution/B
10001,6	015	Name: Sub Monitor Fan2 Rotation Speed Lowering Meaning: For MU-231: Connected to COM2 (Sub Monitor). Fan2 rotation speed is below threshold. Remedy: If the error frequently occurs, contact FURUNO and inform frequency of occurrence.	Caution/B
10001,7	016	Name: Sub Monitor Fan3 Rotation Speed Lowering Meaning: For MU-231: Connected to COM2 (Sub Monitor). Fan3 rotation speed is below threshold. Remedy: If the error frequently occurs, contact FURUNO and inform frequency of occurrence.	Caution/B
10001,8	017	Name: Sub Monitor Fan4 Rotation Speed Lowering Meaning: For MU-190: Connected to COM2 (Sub Monitor). Fan4 rotation speed is below threshold. Remedy: If the error frequently occurs, contact FURUNO and inform frequency of occurrence.	Caution/B
10001,9	011	Name: Main Monitor RS485 Communication Timeout Meaning: For MU-190/231: Connected to COM1. There has been no communication from processor unit through RS485 for 180 seconds. (No communication implies in completed sentence or checksum error.) Remedy: Check the connection of brightness control cable.	Caution/B
10001,10	024	Name: Sub Monitor RS485 Communication Timeout Meaning: For MU-190/231: Connected to COM2. There has been no communication from processor unit through RS485 for 180 seconds. (No communication implies in completed sentence or checksum error.) Remedy: Check the connection of brightness control cable.	Caution/B
10001,11	012	Name: Main Monitor No Signal Meaning: For MU-190/231: Connected to COM1. There has been no signal continuously for 60 seconds. Remedy: Check the connection of video cable.	Caution/B
10001,12	025	Name: Sub Monitor No Signal Meaning: For MU-190/231: Connected to COM2. There has been no signal continuously for 60 seconds. Remedy: Check the connection of video cable.	Caution/B
10001,13	013	Name: Main Monitor Sentence Syntax Error Meaning: For Main monitor, connected to COM1, value of externally input sentence is out of range that defined by sentence. Remedy: If the error frequently occurs, contact FURUNO and inform frequency of occurrence.	Caution/B
10001,14	026	Name: Sub Monitor Sentence Syntax Error Meaning: For Main monitor, connected to COM2, value of externally input sentence is out of range that defined by sentence. Remedy: If the error frequently occurs, contact FURUNO and inform frequency of occurrence.	Caution/B
10001,15	027	Name: Main Monitor COM Timeout Meaning: Communication with MU is interrupted. 60 seconds timeout. Remedy: Check the connection with the monitor.	Caution/B

APPENDIX 4 ALERT LIST

ALF	ALR	Alert Name, Meaning and Remedy	Priority/Category
10001,16	028	Name: Sub Monitor COM Timeout Meaning: Communication with MU is interrupted. 60 seconds time-out. Remedy: Check the connection with the monitor.	Caution/B
10001,17	073	Name: Processor Unit CPU Temp High Meaning: CPU temperature in processor unit exceeds threshold. Remedy: Turn off Processor Unit. If same error occurs after a few minutes, contact FURUNO.	Caution/B
10001,18	074	Name: Processor Unit GPU Temp High Meaning: GPU temperature in processor unit exceeds threshold. Remedy: Turn off Processor Unit. If same error occurs after a few minutes, contact FURUNO.	Caution/B
10001,19	075	Name: Processor Unit CPU Board Temp High Meaning: CPU temperature in processor unit exceeds threshold. Remedy: Turn off Processor Unit. If same error occurs after a few minutes, contact FURUNO.	Caution/B
10001,20	076	Name: Processor Unit Remote 1 Temp High Meaning: CPU temperature in this processor remote control unit exceeds threshold. Remedy: Turn off Processor Unit. If same error occurs after a few minutes, contact FURUNO.	Caution/B
10001,21	077	Name: Processor Unit Remote 2 Temp High Meaning: CPU temperature in this processor remote control unit exceeds threshold. Remedy: Turn off Processor Unit. If same error occurs after a few minutes, contact FURUNO.	Caution/B
10001,22	078	Name: Processor Unit CPU Fan Rotation Speed Lowering Meaning: Rotation speed of CPU fan in processor unit is below threshold. Remedy: If the error frequently occurs, contact FURUNO and inform frequency of occurrence.	Caution/B
10001,23	079	Name: Processor Unit Fan1 Rotation Speed Lowering Meaning: Rotation speed of CPU fan1 in processor unit is below threshold. Remedy: If the error frequently occurs, contact FURUNO and inform frequency of occurrence.	Caution/B
10001,24	080	Name: Processor Unit Fan2 Rotation Speed Lowering Meaning: Rotation speed of CPU fan2 in processor unit is below threshold. Remedy: If the error frequently occurs, contact FURUNO and inform frequency of occurrence.	Caution/B
10001,25	081	Name: Processor Unit Fan3 Rotation Speed Lowering Meaning: Rotation speed of CPU fan3 in processor unit is below threshold. Remedy: If the error frequently occurs, contact FURUNO and inform frequency of occurrence.	Caution/B
10001,26	089	Name: Processor Unit CPU board Battery Power Error Meaning: CPU board battery voltage in processor unit is out of threshold. Remedy: Turn off Processor Unit. If same error occurs after a few minutes, contact FURUNO.	Caution/B

ALF	ALR	Alert Name, Meaning and Remedy	Priority/Category
10001,27	090	Name: Processor Unit CPU board Core Power Error Meaning: CPU board battery voltage in processor unit is out of threshold. Remedy: Turn off Processor Unit. If same error occurs after a few minutes, contact FURUNO.	Caution/B
10001,28	070	Name: RCU 1 COM Timeout Meaning: Communication error with this remote control unit is detected. 40 seconds timeout. Remedy: Check the connection with this remote control unit.	Caution/B
10001,29	071	Name: RCU 2 COM Timeout Meaning: Communication error with No.2 remote control unit is detected. 40 seconds timeout. Remedy: Check the connection with No.2 remote control unit.	Caution/B
10001,30	072	Name: RCU 3 COM Timeout Meaning: Communication error with No.3 remote control unit is detected. 40 seconds timeout. Remedy: Check the connection with No.3 remote control unit.	Caution/B
10001,31	400	Name: Network Printer Not Available Meaning: When executing printout, network printer is not recognized, network printer connection is interrupted, or printer error such as paper shortage, paper jam and run out of ink occurs. Remedy: Check that the printer is connected to network, or printer errors such as paper shortage, paper jam and run out of ink does not occur.	Caution/B
10001,32	401	Name: Local Printer Not Available Meaning: When executing printout, local printer is not recognized, network printer connection is interrupted, or printer error such as paper shortage, paper jam and run out of ink occurs. Remedy: Check that the printer is connected, or printer errors such as paper shortage, paper jam and run out of ink does not occur.	Caution/B
10002,1	005	Name: Main Monitor LCD Unit Lifetime Over* Meaning: For MU-190: Connected to COM1. LCD unit operating time exceeds 50000 hours. For MU-231: Connected to COM1. LCD unit operating time exceeds 50000 hours. Remedy: LCD unit replacement is required. Contact FURUNO.	Warning/B
10002,2	018	Name: Sub Monitor LCD Unit Lifetime Over* Meaning: For MU-190: Connected to COM2. LCD unit operating time exceeds 50000 hours. For MU-231: Connected to COM2. LCD unit operating time exceeds 50000 hours. Remedy: LCD unit replacement is required. Contact FURUNO.	Warning/B
10002,3	006	Name: Main Monitor High Temperature Inside Monitor* Meaning: Internal temperature exceeds threshold. Monitor: Connected to COM1 (Main Monitor). Remedy: If the error frequently occurs, contact FURUNO and inform frequency of occurrence.	Warning/B
10002,4	019	Name: Sub Monitor High Temperature Inside Monitor* Meaning: Internal temperature exceeds threshold. Monitor: Connected to COM2 (Main Monitor). Remedy: If the error frequently occurs, contact FURUNO and inform frequency of occurrence.	Warning/B

APPENDIX 4 ALERT LIST

ALF	ALR	Alert Name, Meaning and Remedy	Priority/Category
10002,5	007	Name: Main Monitor Fan1 No Rotation* Meaning: For MU-190/231: Connected to COM1 (Main Monitor). Fan1 rotation speed is below threshold. Remedy: If the error frequently occurs, contact FURUNO and inform frequency of occurrence.	Warning/B
10002,6	008	Name: Main Monitor Fan2 No Rotation* Meaning: For MU-190/231: Connected to COM1 (Main Monitor). Fan2 rotation speed is below threshold. Remedy: If the error frequently occurs, contact FURUNO and inform frequency of occurrence.	Warning/B
10002,7	009	Name: Main Monitor Fan3 No Rotation* Meaning: For MU-231: Connected to COM1 (Main Monitor). Fan3 rotation speed is below threshold. Remedy: If the error frequently occurs, contact FURUNO and inform frequency of occurrence.	Warning/B
10002,8	010	Name: Main Monitor Fan4 No Rotation* Meaning: For MU-190: Connected to COM1 (Main Monitor). Fan4 rotation speed is below threshold. Remedy: If the error frequently occurs, contact FURUNO and inform frequency of occurrence.	Warning/B
10002,9	020	Name: Sub Monitor Fan1 No Rotation* Meaning: For MU-190/231: Connected to COM2 (Sub Monitor). Fan1 rotation speed is below threshold. Remedy: If the error frequently occurs, contact FURUNO and inform frequency of occurrence.	Warning/B
10002,10	021	Name: Sub Monitor Fan2 No Rotation* Meaning: For MU-190/231: COM2 (Sub Monitor). Fan2 rotation speed is below threshold. Remedy: If the error frequently occurs, contact FURUNO and inform frequency of occurrence.	Warning/B
10002,11	022	Name: Sub Monitor Fan3 No Rotation* Meaning: For MU-231: COM2 (Sub Monitor). Fan3 rotation speed is below threshold. Remedy: If the error frequently occurs, contact FURUNO and inform frequency of occurrence.	Warning/B
10002,12	023	Name: Sub Monitor Fan4 No Rotation* Meaning: For MU-190: Connected to COM2 (Sub Monitor). Fan4 rotation speed is below threshold. Remedy: If the error frequently occurs, contact FURUNO and inform frequency of occurrence.	Warning/B
10002,13	082	Name: Processor Unit CPU Fan No Rotation* Meaning: Rotation speed of fan in processor unit is below threshold. Remedy: If the error frequently occurs, contact FURUNO and inform frequency of occurrence.	Warning/B
10002,14	083	Name: Processor Unit Fan1 Fan No Rotation* Meaning: Rotation speed of fan1 in processor unit is below threshold. Remedy: If the error frequently occurs, contact FURUNO and inform frequency of occurrence.	Warning/B
10002,15	084	Name: Processor Unit Fan2 Fan No Rotation* Meaning: Rotation speed of fan2 in processor unit is below threshold. Remedy: If the error frequently occurs, contact FURUNO and inform frequency of occurrence.	Warning/B

ALF	ALR	Alert Name, Meaning and Remedy	Priority/Category
10002,16	085	Name: Processor Unit Fan3 Fan No Rotation* Meaning: Rotation speed of fan3 in processor unit is below threshold. Remedy: If the error frequently occurs, contact FURUNO and inform frequency of occurrence.	Warning/B
10002,17	086	Name: Processor Unit CPU board 5V Power Error Meaning: 5 V power voltage of CPU board in processor unit is out of threshold. Remedy: If the error frequently occurs, contact FURUNO and inform frequency of occurrence.	Warning/B
10002,18	087	Name: Processor Unit CPU board 3.3V Power Error Meaning: 3.3 V power voltage of CPU board in processor unit is out of threshold. Remedy: If the error frequently occurs, contact FURUNO and inform frequency of occurrence.	Warning/B
10002,19	088	Name: Processor Unit CPU board 12V Power Error* Meaning: 12 V power voltage of CPU board in processor unit is out of threshold. Remedy: If the error frequently occurs, contact FURUNO and inform frequency of occurrence.	Warning/B
10050,1	320	Name: Processor Unit Ch.01 COM Timeout Meaning: Input from EC-3000 serial ch.1 has been discontinued for more than certain time (Set at installation). Default: No timeout Remedy: Check the connection of Ch.1.	Caution/B
10050,2	321	Name: Processor Unit Ch.02 COM Timeout Meaning: Input from EC-3000 serial ch.2 has been discontinued for more than certain time (Set at installation). Default: No timeout Remedy: Check the connection of Ch.2.	Caution/B
10050,3	322	Name: Processor Unit Ch.03 COM Timeout Meaning: Input from EC-3000 serial ch.3 has been discontinued for more than certain time (Set at installation). Default: No timeout Remedy: Check the connection of Ch.3.	Caution/B
10050,4	323	Name: Processor Unit Ch.04 COM Timeout Meaning: Input from EC-3000 serial ch.4 has been discontinued for more than certain time (Set at installation). Default: No timeout Remedy: Check the connection of Ch.4.	Caution/B
10050,5	324	Name: Processor Unit Ch.05 COM Timeout Meaning: Input from EC-3000 serial ch.5 has been discontinued for more than certain time (Set at installation). Default: No timeout Remedy: Check the connection of Ch.5.	Caution/B
10050,6	325	Name: Processor Unit Ch.06 COM Timeout Meaning: Input from EC-3000 serial ch.6 has been discontinued for more than certain time (Set at installation). Default: No timeout Remedy: Check the connection of Ch.6.	Caution/B
10050,7	326	Name: Processor Unit Ch.07 COM Timeout Meaning: Input from EC-3000 serial ch.7 has been discontinued for more than certain time (Set at installation). Default: No timeout Remedy: Check the connection of Ch.7.	Caution/B
10050,8	327	Name: Processor Unit Ch.08 COM Timeout Meaning: Input from EC-3000 serial ch.8 has been discontinued for more than certain time (Set at installation). Default: No timeout Remedy: Check the connection of Ch.8.	Caution/B

APPENDIX 4 ALERT LIST

ALF	ALR	Alert Name, Meaning and Remedy	Priority/Category
10173,1	634	Name: UKC Limit* Meaning: Measured depth from echo sounder is less than set UKC limit value. Remedy: Be careful that measured depth is less than UKC limit.	Warning/A
10173,2	635	Name: Non-official ENC* Meaning: When Non-official ENC is set to Warning/Caution in chart alert, the non-official chart area is detected inside the check area. Remedy: Be careful of the object mentioned above.	Warning/A
10173,3	636	Name: No Vector Chart* Meaning: When No Vector Chart is set to Warning/Caution in chart alert, the No Vector Chart area is detected inside the check area. Remedy: Be careful of the object mentioned above.	Warning/A
10173,4	637	Name: Not Up-to-date* Meaning: When Not Up to Date is set to Warning/Caution in chart alert, a chart area that is not up-to date is detected inside the check area. Remedy: Be careful of the object mentioned above.	Warning/A
10173,5	638	Name: Permit Expired* Meaning: When Permit Expired is set to Warning/Caution in chart alert, a chart area that has an expired permit is detected inside the check area. Remedy: Be careful of the object mentioned above.	Warning/A
10173,6	646	Name: Sounding UKC Limit Meaning: Chart depth for one or more legs is outside of UKC threshold. Remedy: Adjust course accordingly.q	Warning/A
10173,7	647	Name: Too Many Dangers Meaning: Selected route has too many dangerous objects in one or more legs. Remedy: Shorten the route or the look-ahead area.	Warning/A
10190,1	530	Name: AIS Target Display 95% Meaning: 95% of maximum number of target which can be displayed is used. Remedy: The number of AIS target became 95% of that can be displayed. Change the display number using filter function.	Caution/B
10190,3	534	Name: AIS Target Activate 95% Meaning: 95% of capacity for active AIS is used. Remedy: The number of active AIS target became 95% of its limit. Change the unnecessary targets to sleep mode.	Caution/B
10190,4	522	Name: TT Auto ACQ 95% Meaning: Appears when capacity for automatically tracked targets is full. Remedy: Remove TT symbol manually because the capacity for TT is 95%.	Caution/B
10190,5	524	Name: TT MAN ACQ 95% Meaning: Appears when capacity for manually tracked targets is full. Remedy: Remove TT symbol manually because the capacity for TT is 95%.	Caution/B

ALF	ALR	Alert Name, Meaning and Remedy	Priority/Category
10300,1	030	<p>Name: Sensor Adapter 1 COM Timeout</p> <p>Meaning: Communication error with this sensor adapter is detected. 30 seconds timeout. This sensor adapter is turned off, or there is a problem with network.</p> <p>Remedy: Check the connection with No.1 sensor adapter and network.</p>	Caution/B
10300,2	031	<p>Name: Sensor Adapter 2 COM Timeout</p> <p>Meaning: Communication error with No.2 sensor adapter is detected. 30 seconds timeout. No.2 sensor adapter is turned off, or there is a problem with network.</p> <p>Remedy: Check the connection with No.2 sensor adapter and network.</p>	Caution/B
10300,3	032	<p>Name: Sensor Adapter 3 COM Timeout</p> <p>Meaning: Communication error with No.3 sensor adapter is detected. 30 seconds timeout. No.3 sensor adapter is turned off, or there is a problem with network.</p> <p>Remedy: Check the connection with No.3 sensor adapter and network.</p>	Caution/B
10300,4	033	<p>Name: Sensor Adapter 4 COM Timeout</p> <p>Meaning: Communication error with No.4 sensor adapter is detected. 30 seconds timeout. No.4 sensor adapter is turned off, or there is a problem with network.</p> <p>Remedy: Check the connection with No.4 sensor adapter and network.</p>	Caution/B
10300,5	034	<p>Name: Sensor Adapter 5 COM Timeout</p> <p>Meaning: Communication error with No.5 sensor adapter is detected. 30 seconds timeout. No.5 sensor adapter is turned off, or there is a problem with network.</p> <p>Remedy: Check the connection with No.5 sensor adapter and network.</p>	Caution/B
10300,6	035	<p>Name: Sensor Adapter 6 COM Timeout</p> <p>Meaning: Communication error with No.6 sensor adapter is detected. 30 seconds timeout. No.6 sensor adapter is turned off, or there is a problem with network.</p> <p>Remedy: Check the connection with No.6 sensor adapter and network.</p>	Caution/B
10300,7	036	<p>Name: Sensor Adapter 7 COM Timeout</p> <p>Meaning: Communication error with No.7 sensor adapter is detected. 30 seconds timeout. No.7 sensor adapter is turned off, or there is a problem with network.</p> <p>Remedy: Check the connection with No.7 sensor adapter and network.</p>	Caution/B
10300,8	037	<p>Name: Sensor Adapter 8 COM Timeout</p> <p>Meaning: Communication error with No.8 sensor adapter is detected. 30 seconds timeout. No.8 sensor adapter is turned off, or there is a problem with network.</p> <p>Remedy: Check the connection with No.8 sensor adapter and network.</p>	Caution/B
10300,9	038	<p>Name: Sensor Adapter 9 COM Timeout</p> <p>Meaning: Communication error with No.9 sensor adapter is detected. 30 seconds timeout. No.9 sensor adapter is turned off, or there is a problem with network.</p> <p>Remedy: Check the connection with No.9 sensor adapter and network.</p>	Caution/B

APPENDIX 4 ALERT LIST

ALF	ALR	Alert Name, Meaning and Remedy	Priority/Category
10300,10	039	<p>Name: Sensor Adapter 10 COM Timeout</p> <p>Meaning: Communication error with No.10 sensor adapter is detected. 30 seconds timeout. No.10 sensor adapter is turned off, or there is a problem with network.</p> <p>Remedy: Check the connection with No.10 sensor adapter and network.</p>	Caution/B
10300,11	094	<p>Name: Sensor Adapter 11 COM Timeout</p> <p>Meaning: Communication error with No.11 sensor adapter is detected. 30 seconds timeout. No.11 sensor adapter is turned off, or there is a problem with network.</p> <p>Remedy: Check the connection with No.11 sensor adapter and network.</p>	Caution/B
10300,12	095	<p>Name: Sensor Adapter 12 COM Timeout</p> <p>Meaning: Communication error with No.12 sensor adapter is detected. 30 seconds timeout. No.12 sensor adapter is turned off, or there is a problem with network.</p> <p>Remedy: Check the connection with No.12 sensor adapter and network.</p>	Caution/B
10300,13	096	<p>Name: Sensor Adapter 13 COM Timeout</p> <p>Meaning: Communication error with No.13 sensor adapter is detected. 30 seconds timeout. No.13 sensor adapter is turned off, or there is a problem with network.</p> <p>Remedy: Check the connection with No.13 sensor adapter and network.</p>	Caution/B
10300,14	097	<p>Name: Sensor Adapter 14 COM Timeout</p> <p>Meaning: Communication error with No.14 sensor adapter is detected. 30 seconds timeout. No.14 sensor adapter is turned off, or there is a problem with network.</p> <p>Remedy: Check the connection with No.14 sensor adapter and network.</p>	Caution/B
10300,15	098	<p>Name: Sensor Adapter 15 COM Timeout</p> <p>Meaning: Communication error with No.15 sensor adapter is detected. 30 seconds timeout. No.15 sensor adapter is turned off, or there is a problem with network.</p> <p>Remedy: Check the connection with No.15 sensor adapter and network.</p>	Caution/B
10300,16	099	<p>Name: Sensor Adapter 16 COM Timeout</p> <p>Meaning: Communication error with No.16 sensor adapter is detected. 30 seconds timeout. No.16 sensor adapter is turned off, or there is a problem with network.</p> <p>Remedy: Check the connection with No.16 sensor adapter and network.</p>	Caution/B
10310,-	510	<p>Name: IAS COM Timeout*</p> <p>Meaning: Connection to the IAS (MODBUS) is lost or interrupted.</p> <p>Remedy: Check connection.</p>	Warning/B
10331,-	331	<p>Name: Selected Gyro status missing</p> <p>Meaning: When connected with Double Gyro System, instrument produced by Yokogawa Electric, "Double Gyro" status cannot be acquired.</p> <p>Remedy: If the error frequently occurs, contact FURUNO and inform frequency of occurrence.</p>	Warning/B

ALF	ALR	Alert Name, Meaning and Remedy	Priority/Category
10380,131	380	<p>Name: AIS COM Error*</p> <p>Meaning: Data from AIS has been discontinued for more than set time. (Set at installation) Default: 60 seconds AIS is turned off, or there is a problem with network.</p> <p>Remedy: Check the connection with AIS and network.</p>	Warning/B
10400,1	255	<p>Name: Gyro 1 COM Error</p> <p>Meaning: Data from this gyro has been discontinued for more than set time. (Set at installation) Default: 60 seconds This gyro is turned off, or there is a problem with network.</p> <p>Remedy: Check the connection with this gyro and network.</p>	Caution/B
10400,2	256	<p>Name: Gyro 2 COM Error</p> <p>Meaning: Data from this gyro has been discontinued for more than set time. (Set at installation) Default: 60 seconds This gyro is turned off, or there is a problem with network.</p> <p>Remedy: Check the connection with this gyro and network.</p>	Caution/B
10400,3	257	<p>Name: Gyro 3 COM Error</p> <p>Meaning: Data from this gyro has been discontinued for more than set time. (Set at installation) Default: 60 seconds This gyro is turned off, or there is a problem with network.</p> <p>Remedy: Check the connection with this gyro and network.</p>	Caution/B
10400,4	258	<p>Name: Gyro 4 COM Error</p> <p>Meaning: Data from this gyro has been discontinued for more than set time. (Set at installation) Default: 60 seconds This gyro is turned off, or there is a problem with network.</p> <p>Remedy: Check the connection with this gyro and network.</p>	Caution/B
10400,5	259	<p>Name: Gyro 5 COM Error</p> <p>Meaning: Data from this gyro has been discontinued for more than set time. (Set at installation) Default: 60 seconds This gyro is turned off, or there is a problem with network.</p> <p>Remedy: Check the connection with this gyro and network.</p>	Caution/B
10400,11	391	<p>Name: ROT Gyro 1 COM Error</p> <p>Meaning: Data from this ROT gyro has been discontinued for more than set time. (Set at installation) Default: 60 seconds</p> <p>Remedy: Check the connection with this ROT gyro.</p>	Caution/B
10400,12	392	<p>Name: ROT Gyro 2 COM Error</p> <p>Meaning: Data from this ROT gyro has been discontinued for more than set time. (Set at installation) Default: 60 seconds</p> <p>Remedy: Check the connection with this ROT gyro.</p>	Caution/B
10400,13	393	<p>Name: ROT Gyro 3 COM Error</p> <p>Meaning: Data from this ROT gyro has been discontinued for more than set time. (Set at installation) Default: 60 seconds</p> <p>Remedy: Check the connection with this ROT gyro.</p>	Caution/B
10400,21	290	<p>Name: EPFS 1 COM Error</p> <p>Meaning: Ship position data from this GPS has been discontinued for more than set time. (Set at installation) Default: 60 seconds. This GPS is turned off, or there is a problem with network.</p> <p>Remedy: Check the connection with this GPS and network.</p>	Caution/B
10400,22	291	<p>Name: EPFS 2 COM Error</p> <p>Meaning: Ship position data from this GPS has been discontinued for more than set time. (Set at installation) Default: 60 seconds. This GPS is turned off, or there is a problem with network.</p> <p>Remedy: Check the connection with this GPS and network.</p>	Caution/B

APPENDIX 4 ALERT LIST

ALF	ALR	Alert Name, Meaning and Remedy	Priority/Category
10400,23	292	Name: EPFS 3 COM Error Meaning: Ship position data from this GPS has been discontinued for more than set time. (Set at installation) Default: 60 seconds. This GPS is turned off, or there is a problem with network. Remedy: Check the connection with this GPS and network.	Caution/B
10400,24	293	Name: EPFS 4 COM Error Meaning: Ship position data from this GPS has been discontinued for more than set time. (Set at installation) Default: 60 seconds. This GPS is turned off, or there is a problem with network. Remedy: Check the connection with this GPS and network.	Caution/B
10400,25	294	Name: EPFS 5 COM Error Meaning: Ship position data from this GPS has been discontinued for more than set time. (Set at installation) Default: 60 seconds. This GPS is turned off, or there is a problem with network. Remedy: Check the connection with this GPS and network.	Caution/B
10400,26	295	Name: EPFS 6 COM Error Meaning: Ship position data from this GPS has been discontinued for more than set time. (Set at installation) Default: 60 seconds. This GPS is turned off, or there is a problem with network. Remedy: Check the connection with this GPS and network.	Caution/B
10400,27	296	Name: EPFS 7 COM Error Meaning: Ship position data from this GPS has been discontinued for more than set time. (Set at installation) Default: 60 seconds. This GPS is turned off, or there is a problem with network. Remedy: Check the connection with this GPS and network.	Caution/B
10400,28	297	Name: EPFS 8 COM Error Meaning: Ship position data from this GPS has been discontinued for more than set time. (Set at installation) Default: 60 seconds. This GPS is turned off, or there is a problem with network. Remedy: Check the connection with this GPS and network.	Caution/B
10400,29	298	Name: EPFS 9 COM Error Meaning: Ship position data from this GPS has been discontinued for more than set time. (Set at installation) Default: 60 seconds. This GPS is turned off, or there is a problem with network. Remedy: Check the connection with this GPS and network.	Caution/B
10400,30	299	Name: EPFS 10 COM Error Meaning: Ship position data from this GPS has been discontinued for more than set time. (Set at installation) Default: 60 seconds. This GPS is turned off, or there is a problem with network. Remedy: Check the connection with this GPS and network.	Caution/B
10400,41	280	Name: SDME 1 COM Error Meaning: Speed data from this SDME sensor has been discontinued for more than set time. (Set at installation) Default: 60 seconds This SDME sensor is turned off, or there is a problem with network. Remedy: Check the connection with this SDME sensor and network.	Caution/B
10400,42	281	Name: SDME 2 COM Error Meaning: Speed data from this SDME sensor has been discontinued for more than set time. (Set at installation) Default: 60 seconds This SDME sensor is turned off, or there is a problem with network. Remedy: Check the connection with this SDME sensor and network.	Caution/B

ALF	ALR	Alert Name, Meaning and Remedy	Priority/Category
10400,43	282	<p>Name: SDME 3 COM Error</p> <p>Meaning: Speed data from this SDME sensor has been discontinued for more than set time. (Set at installation) Default: 60 seconds This SDME sensor is turned off, or there is a problem with network.</p> <p>Remedy: Check the connection with this SDME sensor and network.</p>	Caution/B
10400,51	235	<p>Name: Echo Sounder 1 COM Error</p> <p>Meaning: Input of depth data from this echo sounder has been discontinued for more than set time. (Set at installation) Default: 60 seconds This echo sounder is turned off, or there is a problem with network.</p> <p>Remedy: Check the connection with this echosounder and network.</p>	Caution/B
10400,52	236	<p>Name: Echo Sounder 2 COM Error</p> <p>Meaning: Input of depth data from this echo sounder has been discontinued for more than set time. (Set at installation) Default: 60 seconds This echo sounder is turned off, or there is a problem with network.</p> <p>Remedy: Check the connection with this echosounder and network.</p>	Caution/B
10400,53	237	<p>Name: Echo Sounder 3 COM Error</p> <p>Meaning: Input of depth data from this echo sounder has been discontinued for more than set time. (Set at installation) Default: 60 seconds This echo sounder is turned off, or there is a problem with network.</p> <p>Remedy: Check the connection with this echosounder and network.</p>	Caution/B
10400,61	300	<p>Name: Rudder 1 COM Error</p> <p>Meaning: Rudder data from this rudder sensor has been discontinued for more than set time. (Set at installation) Default: 60 seconds. This rudder sensor is turned off, or there is a problem with network.</p> <p>Remedy: Check the connection with this rudder sensor and network.</p>	Caution/B
10400,62	301	<p>Name: Rudder 2 COM Error</p> <p>Meaning: Rudder data from this rudder sensor has been discontinued for more than set time. (Set at installation) Default: 60 seconds. This rudder sensor is turned off, or there is a problem with network.</p> <p>Remedy: Check the connection with this rudder sensor and network.</p>	Caution/B
10400,63	302	<p>Name: Rudder 3 COM Error</p> <p>Meaning: Rudder data from this rudder sensor has been discontinued for more than set time. (Set at installation) Default: 60 seconds. This rudder sensor is turned off, or there is a problem with network.</p> <p>Remedy: Check the connection with this rudder sensor and network.</p>	Caution/B
10400,71	303	<p>Name: HCS 1 COM Error</p> <p>Meaning: Data from this HCS has been discontinued for more than set time. (Set at installation) Default: 60 seconds This HCS is turned off, or there is a problem with network.</p> <p>Remedy: Check the connection with this HCS and network.</p>	Caution/B
10400,72	304	<p>Name: HCS 2 COM Error</p> <p>Meaning: Data from this HCS has been discontinued for more than set time. (Set at installation) Default: 60 seconds This HCS is turned off, or there is a problem with network.</p> <p>Remedy: Check the connection with this HCS and network.</p>	Caution/B
10400,81	305	<p>Name: VDR COM Error</p> <p>Meaning: Sentence from VDR has been discontinued for more than set time. (Set at installation) Default: 180 seconds VDR is turned off, or there is a problem with network.</p> <p>Remedy: Check the connection with VDR and network.</p>	Caution/B

APPENDIX 4 ALERT LIST

ALF	ALR	Alert Name, Meaning and Remedy	Priority/Category
10400,91	306	Name: BNWAS1 COM Error Meaning: Caution Sentence from BNWAS1 has been discontinued for more than set time. (Set at installation) Default: 180 seconds BNWAS is turned off, or there is a problem with network. Remedy: Check the connection with BNWAS1 and network.	Caution/B
10400,92	307	Name: BNWAS2 COM Error Meaning: Caution Sentence from BNWAS2 has been discontinued for more than set time. (Set at installation) Default: 180 seconds BNWAS is turned off, or there is a problem with network. Remedy: Check the connection with BNWAS2 and network.	Caution/B
10400,93	308	Name: BNWAS3 COM Error Meaning: Caution Sentence from BNWAS3 has been discontinued for more than set time. (Set at installation) Default: 180 seconds BNWAS is turned off, or there is a problem with network. Remedy: Check the connection with BNWAS3 and network.	Caution/B
10400,101	360	Name: Wind Sensor 1 COM Error Meaning: Data from this wind sensor has been discontinued for more than set time. (Set at installation) Default: 60 seconds This wind sensor is turned off, or there is a problem with network. Remedy: Check the connection with this wind sensor.	Caution/B
10400,102	361	Name: Wind Sensor 2 COM Error Meaning: Data from this wind sensor has been discontinued for more than set time. (Set at installation) Default: 60 seconds This wind sensor is turned off, or there is a problem with network. Remedy: Check the connection with this wind sensor.	Caution/B
10400,103	362	Name: Wind Sensor 3 COM Error Meaning: Data from this wind sensor has been discontinued for more than set time. (Set at installation) Default: 60 seconds This wind sensor is turned off, or there is a problem with network. Remedy: Check the connection with this wind sensor.	Caution/B
10400,111	370	Name: Water Current COM Error Meaning: Data from water current has been discontinued for more than set time. (Set at installation) Default: 60 seconds Water current sensor is turned off, or there is a problem with network. Check the connection with water current and network. Remedy: Check the connection with water current sensor and network.	Caution/B
10400,121	371	Name: Water Temp COM Error Meaning: Data from water temp. has been discontinued for more than set time. (Set at installation) Default: 60 seconds Water temp sensor is turned off, or there is a problem with network. Remedy: Check the connection with water temp sensor and network.	Caution/B
10400,141	390	Name: NAVTEX COM Error Meaning: Data from NAVTEX has been discontinued for more than set time. (Set at installation) Default: 180 seconds NAVTEX is turned off, or there is a problem with network Remedy: Check the connection with NAVTEX and network.	Caution/B
10431,-	431	Name: HUB-3000 LinkUP Error* Meaning: A network error has occurred between the HUB-3000 and one or more connected units. Remedy: Check network connections between the EC-3000 and networked units.	Warning/B

ALF	ALR	Alert Name, Meaning and Remedy	Priority/Category
10450,-	330	<p>Name: Double Gyro Status Conflict*</p> <p>Meaning: When connected with Double Gyro System, instrument produced by Yokogawa Electric, two gyro has been displayed "Selected" status for 3 seconds.</p> <p>Remedy: If the error frequently occurs, contact FURUNO and inform frequency of occurrence.</p>	Warning/B
10499,-	500	<p>Name: Watch Alert*</p> <p>Meaning: Watch alert interval reached.</p> <p>Remedy: ACK the alert, check the radar display.</p>	Warning/B
10500,1	851	<p>Name: EPFS 1 Sensor Banned</p> <p>Meaning: Own ship position data from this GPS is determined abnormal by integrity check.</p> <p>Remedy: Reset the filter to confirm that it isn't a temporal error value. If the data is normal, it is reusable. However, if it's continually removed, there is a possibility that correct data is not received from sensor. In this case, contact FURUNO.</p>	Caution/B
10500,2	852	<p>Name: EPFS 2 Sensor Banned</p> <p>Meaning: Own ship position data from this GPS is determined abnormal by integrity check.</p> <p>Remedy: Reset the filter to confirm that it isn't a temporal error value. If the data is normal, it is reusable. However, if it's continually removed, there is a possibility that correct data is not received from sensor. In this case, contact FURUNO.</p>	Caution/B
10500,3	853	<p>Name: EPFS 3 Sensor Banned</p> <p>Meaning: Own ship position data from this GPS is determined abnormal by integrity check.</p> <p>Remedy: Reset the filter to confirm that it isn't a temporal error value. If the data is normal, it is reusable. However, if it's continually removed, there is a possibility that correct data is not received from sensor. In this case, contact FURUNO.</p>	Caution/B
10500,4	854	<p>Name: EPFS 4 Sensor Banned</p> <p>Meaning: Own ship position data from this GPS is determined abnormal by integrity check.</p> <p>Remedy: Reset the filter to confirm that it isn't a temporal error value. If the data is normal, it is reusable. However, if it's continually removed, there is a possibility that correct data is not received from sensor. In this case, contact FURUNO.</p>	Caution/B
10500,5	855	<p>Name: EPFS 5 Sensor Banned</p> <p>Meaning: Own ship position data from this GPS is determined abnormal by integrity check.</p> <p>Remedy: Reset the filter to confirm that it isn't a temporal error value. If the data is normal, it is reusable. However, if it's continually removed, there is a possibility that correct data is not received from sensor. In this case, contact FURUNO.</p>	Caution/B
10500,6	856	<p>Name: EPFS 6 Sensor Banned</p> <p>Meaning: Own ship position data from this GPS is determined abnormal by integrity check.</p> <p>Remedy: Reset the filter to confirm that it isn't a temporal error value. If the data is normal, it is reusable. However, if it's continually removed, there is a possibility that correct data is not received from sensor. In this case, contact FURUNO.</p>	Caution/B

APPENDIX 4 ALERT LIST

ALF	ALR	Alert Name, Meaning and Remedy	Priority/Category
10500,7	857	<p>Name: EPFS 7 Sensor Banned</p> <p>Meaning: Own ship position data from this GPS is determined abnormal by integrity check.</p> <p>Remedy: Reset the filter to confirm that it isn't a temporal error value. If the data is normal, it is reusable. However, if it's continually removed, there is a possibility that correct data is not received from sensor. In this case, contact FURUNO.</p>	Caution/B
10500,8	858	<p>Name: EPFS 8 Sensor Banned</p> <p>Meaning: Own ship position data from this GPS is determined abnormal by integrity check.</p> <p>Remedy: Reset the filter to confirm that it isn't a temporal error value. If the data is normal, it is reusable. However, if it's continually removed, there is a possibility that correct data is not received from sensor. In this case, contact FURUNO.</p>	Caution/B
10500,9	859	<p>Name: EPFS 9 Sensor Banned</p> <p>Meaning: Own ship position data from this GPS is determined abnormal by integrity check.</p> <p>Remedy: Reset the filter to confirm that it isn't a temporal error value. If the data is normal, it is reusable. However, if it's continually removed, there is a possibility that correct data is not received from sensor. In this case, contact FURUNO.</p>	Caution/B
10500,10	860	<p>Name: EPFS 10 Sensor Banned</p> <p>Meaning: Own ship position data from this GPS is determined abnormal by integrity check.</p> <p>Remedy: Reset the filter to confirm that it isn't a temporal error value. If the data is normal, it is reusable. However, if it's continually removed, there is a possibility that correct data is not received from sensor. In this case, contact FURUNO.</p>	Caution/B
10500,11	871	<p>Name: Gyro 1 Sensor Banned</p> <p>Meaning: Heading data from this Gyro is determined abnormal by integrity check.</p> <p>Remedy: Reset the filter to confirm that it isn't a temporal error value. If the data is normal, it is reusable. However, if it's continually removed, there is a possibility that correct data is not received from sensor. In this case, contact FURUNO.</p>	Caution/B
10500,12	872	<p>Name: Gyro 2 Sensor Banned</p> <p>Meaning: Heading data from this Gyro is determined abnormal by integrity check.</p> <p>Remedy: Reset the filter to confirm that it isn't a temporal error value. If the data is normal, it is reusable. However, if it's continually removed, there is a possibility that correct data is not received from sensor. In this case, contact FURUNO.</p>	Caution/B
10500,13	873	<p>Name: Gyro 3 Sensor Banned</p> <p>Meaning: Heading data from this Gyro is determined abnormal by integrity check.</p> <p>Remedy: Reset the filter to confirm that it isn't a temporal error value. If the data is normal, it is reusable. However, if it's continually removed, there is a possibility that correct data is not received from sensor. In this case, contact FURUNO.</p>	Caution/B

ALF	ALR	Alert Name, Meaning and Remedy	Priority/Category
10500,14	874	<p>Name: Gyro 4 Sensor Banned</p> <p>Meaning: Heading data from this Gyro is determined abnormal by integrity check.</p> <p>Remedy: Reset the filter to confirm that it isn't a temporal error value. If the data is normal, it is reusable. However, if it's continually removed, there is a possibility that correct data is not received from sensor. In this case, contact FURUNO.</p>	Caution/B
10500,15	875	<p>Name: Gyro 5 Sensor Banned</p> <p>Meaning: Heading data from this Gyro is determined abnormal by integrity check.</p> <p>Remedy: Reset the filter to confirm that it isn't a temporal error value. If the data is normal, it is reusable. However, if it's continually removed, there is a possibility that correct data is not received from sensor. In this case, contact FURUNO.</p>	Caution/B
10500,21	861	<p>Name: SDME 1 Sensor Banned</p> <p>Meaning: Own ship speed data from this SDME is determined abnormal by integrity check.</p> <p>Remedy: Reset the filter to confirm that it isn't a temporal error value. If the data is normal, it is reusable. However, if it's continually removed, there is a possibility that correct data is not received from sensor. In this case, contact FURUNO.</p>	Caution/B
10500,22	862	<p>Name: SDME 2 Sensor Banned</p> <p>Meaning: Own ship speed data from this SDME is determined abnormal by integrity check.</p> <p>Remedy: Reset the filter to confirm that it isn't a temporal error value. If the data is normal, it is reusable. However, if it's continually removed, there is a possibility that correct data is not received from sensor. In this case, contact FURUNO.</p>	Caution/B
10500,23	863	<p>Name: SDME 3 Sensor Banned</p> <p>Meaning: Own ship speed data from this SDME is determined abnormal by integrity check.</p> <p>Remedy: Reset the filter to confirm that it isn't a temporal error value. If the data is normal, it is reusable. However, if it's continually removed, there is a possibility that correct data is not received from sensor. In this case, contact FURUNO.</p>	Caution/B
10500,31	881	<p>Name: ROT Gyro 1 Sensor Banned</p> <p>Meaning: Heading data from this ROT Gyro is determined abnormal by integrity check.</p> <p>Remedy: Reset the filter to confirm that it isn't a temporal error value. If the data is normal, it is reusable. However, if it's continually removed, there is a possibility that correct data is not received from sensor. In this case, contact FURUNO.</p>	Caution/B
10500,32	882	<p>Name: ROT Gyro 2 Sensor Banned</p> <p>Meaning: Heading data from this ROT Gyro is determined abnormal by integrity check.</p> <p>Remedy: Reset the filter to confirm that it isn't a temporal error value. If the data is normal, it is reusable. However, if it's continually removed, there is a possibility that correct data is not received from sensor. In this case, contact FURUNO.</p>	Caution/B

APPENDIX 4 ALERT LIST

ALF	ALR	Alert Name, Meaning and Remedy	Priority/Category
10500,33	883	<p>Name: ROT Gyro 3 Sensor Banned</p> <p>Meaning: Heading data from this ROT Gyro is determined abnormal by integrity check.</p> <p>Remedy: Reset the filter to confirm that it isn't a temporal error value. If the data is normal, it is reusable. However, if it's continually removed, there is a possibility that correct data is not received from sensor. In this case, contact FURUNO.</p>	Caution/B
10510,1	900	<p>Name: No Filter Source of Position</p> <p>Meaning: No valid position sensor is available for filter. (Banned or connection error)</p> <p>Remedy: Check the connection with all GPS.</p>	Warning/B
10510,2	901	<p>Name: No Filter Source of COG/SOG</p> <p>Meaning: No valid COG/SOG sensor is available for filter. (Banned or connection error)</p> <p>Remedy: Check the connection with all GPS.</p>	Warning/B
10510,3	902	<p>Name: No Filter Source of CTW/STW</p> <p>Meaning: No valid CTW/STW sensor is available for filter. (Banned or connection error)</p> <p>Remedy: Check the connection with all GPS.</p>	Warning/B
10510,4	903	<p>Name: No Filter Source of Heading</p> <p>Meaning: No valid heading sensor is available for filter. (Banned or connection error)</p> <p>Remedy: Check the connection with all GPS.</p>	Warning/B
10510,5	904	<p>Name: No Filter Source of ROT</p> <p>Meaning: No valid heading sensor is available for filter. (Banned or connection error)</p> <p>Remedy: Check the connection with all GPS.</p>	Warning/B
10540,1	539	<p>Name: AIS Message Received</p> <p>Meaning: AIS message is received.</p>	Caution/B
10540,2	541	<p>Name: AIS Message Transmit Error</p> <p>Meaning: AIS message transmission failed.</p> <p>Remedy: Check the connection with AIS.</p>	Caution/B
10601,1	272	<p>Name: UTC Time Not Available*</p> <p>Meaning: Time data of all available GPS sensor has been not available for more than 3 seconds.</p> <p>Remedy: Check the connection with all GPS.</p>	Warning/B
10601,2	277	<p>Name: Wind Speed/Direction Not Available*</p> <p>Meaning: Wind speed/direction data of all available WIND sensors has been not available for more than 3 seconds.</p> <p>Remedy: Check the connection with all wind sensors.</p>	Warning/B
10601,3	279	<p>Name: COG/SOG Not Available*</p> <p>Meaning: COG/SOG data of all available GPS sensor has been not available for more than 3 seconds.</p> <p>Remedy: Check the connection with all GPS.</p>	Warning/B
10601,4	284	<p>Name: SOG Not Available*</p> <p>Meaning: There is no SOG sensor data or the SOG sentence is invalid.</p> <p>Remedy: Check that the sensor is powered.</p>	Warning/B

ALF	ALR	Alert Name, Meaning and Remedy	Priority/Category
10601,5	450	Name: Heading Sensor Not Available Meaning: Heading data of all available gyro has been not available for more than 2 seconds. Remedy: Check the connection with all gyro.	Warning/B
10601,6	453	Name: SDME Sensor Not Available* Meaning: Speed data from all available SDME has been not available for more than 3 seconds. Remedy: Check the connection with all SDME.	Warning/B
10602,1	472	Name: Position Source Change Meaning: Position sensor used in system (distributed by own ship's information management) is changed.	Caution/B
10602,2	473	Name: Heading Source Change Meaning: Heading sensor used in system (distributed by own ship's information management) is changed.	Caution/B
10602,3	474	Name: COG/SOG Source Change Meaning: COG/SOG sensor used in system (distributed by own ship's information management) is changed.	Caution/B
10602,4	475	Name: CTW/STW Source Change Meaning: CTW/STW sensor used in system (distributed by own ship's information management) is changed.	Caution/B
10602,5	470	Name: Datum Change Meaning: Current datum of EPFS is changed. Acquisition timing: Once in 60 seconds or when position sensor is changed. Remedy: Check the operator's manual of the GPS.	Caution/B
10603,1	273	Name: Depth (Bow) Not Available Meaning: Depth data of all available depth sensors (Bow) has been not available for more than 3 seconds. Remedy: Check the connection with all echo sounders.	Caution/B
10603,2	274	Name: Depth Midship Not Available Meaning: Depth data of all available depth sensors (Midship) has been not available for more than 3 seconds. Remedy: Check the connection with all echo sounders.	Caution/B
10603,3	275	Name: Depth (Stern) Not Available Meaning: Depth data of all available depth sensors (Stern) has been not available for more than 3 seconds. Remedy: Check the connection with all echo sounders.	Caution/B
10603,4	278	Name: STW Not Available Meaning: STW data of all available SDME sensors has been not available for more than 3 seconds. Remedy: Check the connection with all SDME.	Caution/B
10603,5	285	Name: Heading Magnetic Not Available Meaning: Heading data of all available magnetic gyro has been not available for more than 3 seconds. Remedy: Check the connection with all magnetic gyro.	Caution/B
10644,-	644	Name: Actual UKC Limit Meaning: Actual depth is outside the preset UKC limit. Remedy: Check depth, adjust heading accordingly.	Warning/A

APPENDIX 4 ALERT LIST

ALF	ALR	Alert Name, Meaning and Remedy	Priority/Category
10700,-	700	Name: RT Version is higher Meaning: Received route transfer sentence (RTZ) is a higher version than this system. Remedy: Check route details. Some route details may not be displayed correctly.	Caution/B
10718,-	728	Name: Radar Sensor SW Version Error* Meaning: Software version not correct. Remedy: Update the radar software. If the problem persists, consult your dealer.	Warning/B
10740,1	730	Name: EXT Radar STBY* Meaning: The antenna unit selected with the Interswitch is in stand-by Remedy: Set the antenna unit to transmit state.	Warning/B
10740,2	740	Name: EXT Radar No Signal* Meaning: No video signal from the antenna unit selected with the Interswitch. Remedy: Check the antenna unit.	Warning/B
10740,3	750	Name: EXT Radar COM Error* Meaning: No communication from the antenna unit selected with the Interswitch. Remedy: Check that both the antenna unit and the processor unit are powered. Also check the wiring between the antenna unit and the processor unit.	Warning/B
10755,1	755	Name: SART DETECTED Meaning: A SART signal was detected. This alert appears only for FAR-3220-NXT(-BB) and FAR-3320-NXT. Remedy: Press the ALARM ACK key. Show the SART marks on the radar display, referring to section 2.36.2. Note: Keep in mind the following points: <ul style="list-style-type: none"> • This alert can occur when this equipment receives interference simultaneously from multiple radars. • This alert may not occur under the bad weather conditions such as at rain. 	Warning/B
10760,-	760	Name: Datum Mismatch Meaning: Datum mismatch between EPFS and chart. Remedy: Match the datum.	Caution/B
10800,1	691	Name: RM Stop - Exceed Max XTD Meaning: Route monitoring is stopped because distance from route is more than set value of Max XTD. Remedy: Start route monitoring after approaching the monitoring route.	Alarm/A
10800,2	692	Name: RM Stop - Sensor lost Meaning: Error occurs inside of route monitoring function. Remedy: If the error frequently occurs, contact FURUNO and inform frequency of occurrence.	Alarm/A
10800,3	693	Name: RM Stop - Internal Error Meaning: Required data for route monitoring such as position, SOG/COG cannot be acquired. Remedy: Check the connection with GYRO, GPS and SDME.	Alarm/A

ALF	ALR	Alert Name, Meaning and Remedy	Priority/Category
10801,-	485	Name: Depth Limit* Meaning: Seabed has been less than set depth for more than 3 seconds. Remedy: Be careful of risk of grounding.	Alarm/A
10802,-	495	Name: Anchor Watch** Meaning: While anchor watch alert function is enabled, ship's position has been outside of alarm area centering certain position for more than 3 seconds. Remedy: Be careful of dragging anchor.	Warning/A
10803,-	640	Name: Chartalign: Over 30 min* Meaning: Own ship position has been offset for more than 30 minutes. Remedy: Reset offset.	Caution/B
10807,-	820	Name: NAVTEX Message Received 30 min* Meaning: NAVTEX message is received.	Caution/B
10850,-	652	Name: End of Track Meaning: Ship will reach last waypoint in 30 seconds. Remedy: Be careful that last waypoint is approaching.	Warning/A
10860,1	645	Name: Navigational Hazard Meaning: One or more navigational hazards detected by the Look-ahead function. Remedy: Adjust course as necessary.	Warning/A
10910,1	911	Name: Wave Analyzer Error(UTC) Meaning: An input error has occurred for time/date data. Remedy: Check data input to the Wave Analysis software.	Caution/B
10910,2	912	Name: Wave Analyzer Error(Speed/Course) Meaning: An input error has occurred for speed/course data. Remedy: Check data input to the Wave Analysis software.	Caution/B
10910,3	913	Name: Wave Analyzer Error(Wind) Meaning: An input error has occurred for wind data. Remedy: Check data input to the Wave Analysis software.	Caution/B
10910,4	914	Name: Wave Analyzer Error(Radar) Meaning: An input error has occurred for radar data. Remedy: Check data input to the Wave Analysis software.	Caution/B
10910,5	915	Name: Wave Analyzer Error(Gyro) Meaning: An input error has occurred for gyrocompass data. Remedy: Check data input to the Wave Analysis software.	Caution/B
10950,-	950	Name: BAM COM Error Meaning: Communication with the Bridge Alert Management System interrupted. BAM is turned off, or there is a problem with network. Remedy: Check the connection with BAM and network.	Caution/B
10999,-	999	Name: Alert setting file read error*	Warning/B

APPENDIX 5 RADIO REGULATORY INFORMATION

USA-Federal Communications Commission (FCC)

This device complies with part 15 of the FCC Rules. Operation is subject to the following two conditions:

- (1) This device may not cause harmful interference, and
- (2) This device must accept any interference received, including interference that may cause undesired operation. Any changes or modifications not expressly approved by the party responsible for compliance could void the user's authority to operate the equipment.

Caution: Exposure to Radio Frequency Radiation

- This equipment complies with FCC radiation exposure limits set forth for an uncontrolled environment and meets the FCC radio frequency (RF) Exposure Guidelines in Supplement C to OET65.
- This equipment should be installed and operated keeping the radiator at least XX cm or more away from person's body.
- This device must not be co-located or operating in conjunction with any other antenna or transmitter.

Innovation, Science and Economic Development Canada (ISED)

This device contains licence-exempt transmitter(s)/receiver(s) that comply with Innovation, Science and Economic Development Canada's licence-exempt RSS(s). Operation is subject to the following two conditions:

- (1) This device may not cause interference.
- (2) This device must accept any interference, including interference that may cause undesired operation of the device.

Cet appareil contient un ou plusieurs émetteurs / récepteurs exempts de licence qui sont conformes à la norme « exempts de licence RSS (s) » Canadienne d'Innovation, Sciences et Développement économique. L'exploitation est autorisée aux deux conditions suivantes:

- (1) l'appareil ne doit pas produire de brouillage.
- (2) l'utilisateur de l'appareil doit accepter tout brouillage radioélectrique subi, même si le brouillage est susceptible d'en compromettre le fonctionnement.

Caution: Exposure to Radio Frequency Radiation

This equipment complies with ISED radiation exposure limits set forth for an uncontrolled environment and meets RSS-102 of the ISED radio frequency (RF) Exposure rules. This equipment should be installed and operated keeping the radiator at least XX cm or more away from person's body.

Cet équipement est conforme aux limites d'exposition aux rayonnements énoncées pour un environnement non contrôlé et respecte les règles d'exposition aux fréquences radioélectriques (RF) CNR-102 de l'ISED. Cet équipement doit être installé et utilisé en gardant une distance de XX cm ou plus entre le dispositif rayonnant et le corps.

To reduce potential radio interference to other users, the antenna type and its gain should be so chosen that the equivalent isotropically radiated power (EIRP) is not more than that required for successful communication.

XX cm

FAR-3210(-BB) FAR-3310	RTR-105	440 cm	FAR-3330SW FAR-3230SW-BB	RTR-109	230 cm
FAR-3220(-BB) FAR-3320	RTR-106	950 cm	FAR-3230S-SSD(-BB) FAR-3330S-SSD	RTR-111	100 cm
FAR-3320W(-BB)	RTR-108	550 cm	FAR-3220-NXT(-BB)/ FAR-3320-NXT/	RTR-123	330 cm
FAR-3230S(-BB) FAR-3330S	RTR-107	460 cm			

SPECIFICATIONS OF MARINE RADAR/ARPA FAR-32x0/33x0 SERIES

1 ANTENNA RADIATOR

- 1.1 Type Slotted waveguide array
- 1.2 Beam width and sidelobe attenuation

Radiator type	X-band			S-band		
	XN12CF	XN20CF	XN24CF	SN24CF	SN30CF	SN36CF
Length	4 ft	6.5 ft	8 ft	8 ft	10 ft	12 ft
Horizontal beam width	1.9°	1.23°	0.95°	2.6°	2.3°	1.8°
Vertical beam width	20°			25°		
Sidelobe within ±10°	-24 dB	-28 dB	-28 dB	—		-24 dB
Sidelobe outside ±10°	-30 dB	-32 dB	-32 dB	—		-30 dB
Sidelobe within ±20°	—			-23 dB	-24 dB	—
Sidelobe outside ±20°	—			-27 dB	-30 dB	—

- 1.3 Polarization Horizontal
- 1.4 Rotation 24 rpm or 42 rpm (for high speed craft)
- 1.5 Wind load 100 kn relative

2 TRANSCEIVER

2.1 TX Frequency and modulation

- X-band (Magnetron) 9410 MHz ±30 MHz, P0N
- X-band (Solid state) CH1: 9403.75 MHz (P0N)/ 9423.75 MHz ±5 MHz (Q0N) or
CH2: 941.75 MHz (P0N)/ 9433.75 MHz ±5 MHz (Q0N)
- S-band (Magnetron) 3050 MHz ±30 MHz, P0N
- S-band (Solid state) CH1: 3043.75 MHz (P0N)/ 3063.75 MHz ±5 MHz (Q0N) or
CH2: 3053.75 MHz (P0N)/ 3073.75 MHz ±5 MHz (Q0N)

2.2 Output power

- FAR-3210/3310 12 kW
- FAR-3220/3320/3320W 25 kW
- FAR-3220-NXT/3320-NXT 600 W
- FAR-3230S/3330S/3330SW 30 kW
- FAR-3230S-SSD/3330S-SSD 250 W

2.3 Pulse Repetition Rate, Range scale and Pulselength, X/S-band Magnetron radar

PRR (Hz approx.)	Range scale (NM)																				
	0.125	0.25	0.5	0.75	1	1.5	2	3	4	6	8	12	16	24	32	48	72	96			
3000*	S1																				
3000*			S2																		
1500				M1																	
1200					M2																
1000						M3															
600**									L												

1/2/4/8/16/32/72 NM ranges: non-IMO radar only

*: 2200 Hz with TT range on 32 NM. **: 500 Hz on 96 NM range.

X-band Solid state radar

PRR (Hz approx.)	Range scale (NM)																		
	0.125	0.25	0.5	0.75	1	1.5	2	3	4	6	8	12	16	24	32	48	72	96	
1500	S1																		
1500		S2																	
1200			M1																
1000				M2															
1000					M3														
600								L											

1/2/4/8/16/32/72 NM ranges: non-IMO radar only

S-band Solid state radar

PRR (Hz approx.)	Range scale (NM)																		
	0.125	0.25	0.5	0.75	1	1.5	2	3	4	6	8	12	16	24	32	48	72	96	
2400*	S1																		
2000*		S2																	
1500			M1																
1060				M2															
1000					M3														
600								L											

1/2/4/8/16/32/72 NM ranges: non-IMO radar only

*: 1800 Hz (S1) and 1500 Hz (S2) with TT range on 32 NM.

3 PROCESSOR UNIT

- 3.1 Minimum range 22 m
- 3.2 Range discrimination 26 m
- 3.3 Range accuracy 1% of the maximum range of the scale in use or 10 m, whichever is the greater
- 3.4 Bearing discrimination
 X-band: 2.1° (XN12CF), 1.5° (XN20CF), 1.2° (XN24CF)
 S-band: 2.8° (SN24CF), 2.5° (SN30CF), 2.0° (SN36CF)
- 3.5 Bearing accuracy ±1°
- 3.6 Range scale and Range ring interval (RI)

Range (NM)	0.125	0.25	0.5	0.75	1	1.5	2	3	4	6	8	12	16	24	32	48	72	96
RI (NM)	0.025	0.05	0.1	0.25	0.25	0.25	0.5	0.5	1	1	2	2	4	4	8	8	12	16
Number of rings	5	5	5	3	4	6	4	6	4	6	4	6	4	6	4	6	6	6

- 3.7 Warm-up time 3 min. approx. (solid state radar excluded)
- 3.8 Orientation mode Head-up RM, STAB head-up RM, Course-up RM, North-up RM
North-up TM, Stern-up RM
- 3.9 Stabilization mode Ground or sea stabilization
- 3.10 Target tracking (TT) Auto or manual acquisition: 200 targets in 32 NM
Auto tracking on all acquired targets,
Past position: 5/10 pts on all activated targets
Vector time: Off, 30 s, 1-60 min
- 3.11 AIS Capacity: 2000 targets,
Past position: 5/10 pts on all activated targets
Vector time: Off, 30 s, 1-60 min
- 3.12 Radar map 10 maps, 4,000 pts per map
- 3.13 Acquisition zone 2 zones

4 MONITOR UNIT

- 4.1 Screen type
 - MU-190 19-inch color LCD, 1280 x 1024 (SXGA)
 - MU-231 23.1-inch color LCD, 1600 x 1200 (UXGA)
 - MU-270W 27-inch color LCD, 1920 x 1200 (WUXGA)
- 4.2 Brightness
 - MU-190 450 cd/m² typical
 - MU-231/270W 400 cd/m² typical
- 4.3 Visible distance
 - MU-190/270W 1.02 m nominal
 - MU-231 1.2 m nominal
- 4.4 Video interface DVI-D: DVI-standard, VESA-DDC2B
- 4.5 Brilliance control RS-485, serial data control (DDC sentence)

5 INTERFACE

- 5.1 Processor unit (EC-3000)
 - Number of port
 - Serial 7 ports (IEC61162-1/2: 4 ports, IEC61162-1: 3 ports)
 - Alarm output 6 ports: contact signal, load current 250mA
Normal close: 2, Normal open: 2,
System fail: 1 (n/c), Power fail: 1 (n/c)
 - DVI output 3 ports: DVI-D (2), DVI-I or RGB picture data (1 port for VDR)
 - USB 4 ports (3 ports for control units)
 - LAN 2 ports: Ethernet 1000Base-T for local communication
 - Digital input 1 port: contact signal, 100 ohm max. or 24VDC input
 - Data sentences (IEC61162-1/2)
 - Input ABK, ACK, ACN (ACM), ALR, CUR, DBT, DPT, DTM, GGA, GLL, GNS, HBT, HDT, MTW, MWV, NRX, NSR, RMC, RRT, THS, VBW, VDM, VDO, VDR, VHW, VSD, VTG, ZDA
 - Output ABM, ACK, ALC, ALF, ALR, ARC, BBM, EVE, HBT, OSD, RRT, RSD, TLB, TTD, TTM, VSD
- 5.2 Sensor adapter (option)
 - MC-3000S (serial) 8 ports: I/O, IEC61162-1/2: 4 ports, IEC61162-1: 4 ports
 - MC-3010A (analog) 3 ports: Input, -10 to +10 V, 0 to 10 V or 4 to 20 mA
 - MC-3020D (digital-in) 8 ports: relay contact, logics set from program
 - MC-3030D (digital-out) 8 ports: relay contact, normal open and normal close available
- 5.3 Ethernet interface for IEC61162-450 (EC-3000)
 - Port (LAN2) 1000Base-T, IPv4, 8P8C connector
 - Data sentences Same as 5.1 sentences
 - IEC61162-450 transmission group
 - Input MISC, TGTD, SATD, NAVD, VDRD, RCOM, TIME, PROP, USR1 to USR8
 - Output Arbitrary (default: TGTD)
 - Multicast address 239.192.0.1 to 239.192.0.16
 - Destination port 60001 to 60016
 - Re-transmittable binary image transfer
 - Multicast address 239.192.0.26 to 239.192.0.30

- Destination port 60026 to 60030
- Other network function excepted IEC61162-450
 - HTTP: *.*.*: 80, XML-RPC: *.*.*: 6403
 - Syslog: 239.192.0.254: 514
- 5.4 Ethernet interface for IEC61162-450 (MC-3000S)
 - Port 100Base-TX, IPv4, 8P8C connector
 - Maximum data rate 800 sps
 - Data sentences Output: XDR
 - IEC61162-450 transmission group
 - Input MISC, TGTD, SATD, NAVD, VDRD, RCOM, TIME, PROP, USR1 to USR8
 - Output Arbitrary (default: MISC)
 - Multicast address 239.192.0.1 to 239.192.0.16
 - Destination port 60001 to 60016
 - Other network function excepted IEC61162-450
 - HTTP: *.*.*: 80, XML-RPC: *.*.*: 6403
 - Syslog: 239.192.0.254: 514
- 6 POWER SUPPLY**
 - 6.1 Power supply unit (w/ antenna and transceiver unit)
 - FAR-3210/3310 (X-band, 12 kW)
 - PSU-014 (24rpm) 100-230 VAC: 1.8-0.9 A, 1 phase, 50-60 Hz
 - PSU-014 (42rpm) 100-230 VAC: 2.5-1.2 A, 1 phase, 50-60 Hz
 - FAR-3220/3320/3320W (X-band, 25 kW)
 - PSU-014 (24rpm) 100-230 VAC: 2.0-1.0 A, 1 phase, 50-60 Hz
 - PSU-014 (42rpm) 100-230 VAC: 2.8-1.3 A, 1 phase, 50-60 Hz
 - FAR-3220-NXT/3320-NXT (X-band, SSD)
 - PSU-014 (24rpm) 100-230 VAC: 1.8-0.9 A, 1 phase, 50-60 Hz
 - PSU-014 (42rpm) 100-230 VAC: 2.5-1.2 A, 1 phase, 50-60 Hz
 - FAR-3230S/3330S/3330SW (S-band, magnetron)
 - PSU-014 (24rpm) 100-230 VAC: 2.8-1.3 A, 1 phase, 50-60 Hz
 - PSU-015 (42rpm) 100-230 VAC: 5.1-2.3 A, 1 phase, 50-60 Hz
 - FAR-3230S-SSD/3330S-SSD (S-band, SSD)
 - PSU-016 (24rpm) 100-230 VAC: 2.3-1.1 A, 1 phase, 50-60 Hz
 - PSU-018 (42rpm) 100-230 VAC: 4.7-2.1 A, 1 phase, 50-60 Hz
 - 6.2 Processor unit (EC-3000) 100-115/220-230 VAC: 1.5/0.7 A, 1 phase, 50-60 Hz
 - 6.3 Monitor unit
 - MU-190 100-230 VAC: 0.7-0.4 A, 1 phase, 50-60 Hz
 - MU-231 100-230 VAC: 1.0-0.6 A, 1 phase, 50-60 Hz
 - MU-270W 100-230 VAC: 0.7-0.4 A, 1 phase, 50-60 Hz
 - 6.4 Sensor adapter (option) 24 VDC: 1.4 A (for 11 units), input to MC-3000S, the sources of other sensor adapters are fed from MC-3000S
 - 6.5 Switching HUB (option)
 - HUB-3000 100-230 VAC: 0.1 A max. 1 phase, 50/60 Hz
 - HUB-100 100-230 VAC: 0.1 A max. 1 phase, 50/60 Hz
 - 6.6 Transformer (option) 440 VAC: 1 phase, 50/60 Hz
 - 6.7 De-icer (option) 100-115/220-230 VAC: 2.6/1.3 A, 1 phase, 50-60 Hz

7 ENVIRONMENTAL CONDITIONS

7.1	Ambient temperature	
	Antenna unit	-25°C to +55°C (storage: -25°C to +70°C)
	Indoor units	-15°C to +55°C
7.2	Relative humidity	95% or less at +40°C
7.3	Degree of protection	
	Antenna unit	IP56
	Processor unit	IP20 (IP22: option)
	Sensor adapter	IP20 (IP22: option)
	Transceiver unit	IP20
	HUB	HUB-100: IP20, HUB-3000: IP22
	Control/ monitor/ power supply unit	IP22
7.4	Vibration	IEC 60945 Ed.4

8 UNIT COLOR

8.1	Antenna unit	N9.5
8.2	Power supply unit	N2.5
8.3	Processor unit	N2.5
8.4	Control/ monitor unit	N2.5
8.5	Transceiver unit	N2.5
8.6	HUB	HUB-100: N3.0, HUB-3000: N2.5
8.7	Radar console	2.5GY5/1.5 (standard), 7.5BG7/2, 2.5G7/2, N7.5

9 PERFORMANCE MONITOR

9.1	PM-32 (X-band, MAG)	
	Frequency range	9380 to 9440 MHz
	Input power	+18 dBm to +30 dBm
	Output power	-21 dBm (1 st pulse max. output), -41 dBm (1 st pulse min. output)
	Step level	8 to 12 dB (1 st pulse to last pulse)
9.2	PM-32B (X-band, SSD)	
	Frequency range	9423.75 ±1.6 MHz
	Input power	+6 dBm to +25 dBm
	Output power	-35 dBm (1 st pulse max. output), -66 dBm (1 st pulse min. output)
	Step level	8 to 12 dB (1 st pulse to last pulse)
9.3	PM-52A (S-band, MAG)	
	Frequency range	3040 to 3080 MHz
	Input power	+25 dBm to +40 dBm
	Output power	-38 dBm (1 st pulse max. output), -58 dBm (1 st pulse min. output)
	Step level	8 to 12 dB (1 st pulse to last pulse)
9.4	PM-52B (S-band, SSD)	
	Frequency range	3063.75 ±2 MHz
	Input power	+5 dBm to +25 dBm
	Output power	-52 dBm (1 st pulse max. output), -72 dBm (1 st pulse min. output)
	Step level	8 to 12 dB (1 st pulse to last pulse)

This page is intentionally left blank.

INDEX

A

A/C RAIN control 2-5
A/C SEA control 2-3
ACQ/ACT key 4-6
Acquisition zone
 acknowledging alarm for 3-5
 deactivating 3-5
 sleeping 3-5
 stabilization 3-5
AIO
 chart cells 9-10
 chart object information 9-10
 displaying 9-9
 information to display 9-11
 information to display (S57) 10-4
AIS
 association 4-15
 association, conditions for 4-14, 18-9
 automatic activation of targets 4-6
 automatic target activation
 (chart mode) 18-6
 CPA/TCPA alarm 4-11
 deleting received and sent
 safety messages 17-3
 filtering targets 4-6
 filtering targets (chart mode) 18-5
 function off 4-2
 hiding 4-3
 lost target 4-12
 lost target alert 4-12
 Lost target alert filter (chart mode) 18-7
 lost target filter 4-13
 messages, displaying 4-18
 messages, receiving 4-18
 messages, transmitting 4-16, 4-17
 own ship data (chart mode) 18-9
 past position display 4-13
 pop-up info 4-8
 received and sent safety
 messages 17-2, 17-3
 ROT tag limit 4-19
 scaled symbol 4-20
 sending safety messages 17-1
 showing 4-3
 sleeping activated targets (chart mode) 18-6
 sleeping targets 4-7
 symbol brilliance 4-11
 symbol color 4-12
 symbols 4-3
 symbols (chart mode) 18-4
 target data (basic) 4-8
 target data (chart mode) 18-7, 18-8
 target data (expanded) 4-10
 vectors 4-14

voyage data 4-15, 18-4
 voyage data (chart mode) 18-4
Alert box 2-62, 6-12, 20-2
Alert list 20-7
Alert log 20-10
Alert parameters page 12-8
Alert state icon 20-4
Alerts
 acknowledging 20-6
 alert list 20-7
 alert log 20-10
 alert state icons 20-4
 buzzer silencing 20-5
 buzzer stop button 20-5
 definition 20-1
 message format 20-3
Anchor watch 2-59, 15-10
Antenna marker 2-38
ARCS charts
 license restoring 7-12
Area report 13-16
Association 4-14, 18-9
Automatic Clutter Elimination (ACE)
 function 2-9

B

Barge marker 2-37
Basic setting page 8-3
Bearing measurement
 chart 6-21
 radar, chart radar 2-23
BRILL control 1-8
Brilliance
 AIS symbol 4-11
 AIS symbol brilliance 4-11
 backlight 1-8
 monitor 1-8
 screen data 2-40
 TT symbol 3-8
Buzzer stop button 20-5

C

CCRP 2-56
CCRP page 22-17
CCRS 16-1
Chart alerts
 introduction 11-1
 objects used in 11-3
 own ship check 11-4
 route planning 11-5
Chart cells
 catalog of 7-15
 deleting 7-18
 editing 7-18
 grouping 7-17

INDEX

- status.....7-19
- Chart database (chart radar).....2-68
- Chart database button8-12
- CHART DISP button2-65
- Chart display indications1-14
- Chart legend
 - C-MAP.....10-2
 - S57.....9-2
- Chart objects (chart radar)
 - custom sets of.....2-67
- CHART ON/OFF button2-65
- Chart radar display indications.....1-13
- Chart scale.....6-16
- Chart scale indication (chart radar).....2-69
- Chart synchronization
 - select units to synchronize.....7-28
 - synchronization status.....7-28
- Chart usage log.....19-8
- Charts
 - cell deleting.....7-18
 - cell editing.....7-18
- Check area page.....11-4, 15-7
- Check results page12-10
- Circle report13-16
- Clearing line report.....13-15
- C-MAP charts
 - cartographic services10-1
 - catalog of chart cells7-15
 - chart cell grouping.....7-17
 - chart cell status7-19
 - chart legend10-2
 - database deletion.....7-11
 - database installation7-7
 - deleting.....7-22
 - eToken registration7-7
 - export list of.....7-11
 - install/update history7-14
 - license installation.....7-9
 - opening7-19
 - permit status.....7-13
 - update file, applying7-10
 - update file, generating.....7-10
- COG/SOG page16-4
- Color differentiation test (S57 charts)25-10
- Context-sensitive menu
 - EBL, VRM on chart6-22
 - radar.....1-26
 - radar, chart radar1-24
- Context-sensitive menus
 - chart6-13
- Controls.....1-1
- Cost parameters21-3
- Course-up mode2-18
- CPA/TCPA alarm
 - AIS4-11
 - TT.....3-17
- Cursor attributes2-38
- Cursor position box
 - chart6-18
 - radar, chart radar1-27
- Curved EBL.....2-39
- Customize page22-10
- Customized echo
 - editing.....2-15
 - restoring to factory default settings2-16
 - restoring to saved settings2-16
 - selection2-14
- D**
- Danger targets log
 - viewing19-9
- Data sharing.....22-9
- Deep contour8-1
- Depth sensor.....16-15
- Details log19-5
- Display date9-4
- Display test page22-11
- Divider
 - activating15-14
 - characteristics15-15
 - limitations15-15
- Doppler feature2-61
- Drop mark
 - bearing reference.....2-58
 - erasing2-59
 - hiding.....2-58
 - inscribing2-58
 - showing2-58
- Dual radar2-50
- Dynamic trial maneuver3-20
- E**
- EBL
 - bearing measurement on chart6-21
 - bearing measurement on radar,
 - chart radar2-23
 - bearing reference on chart.....6-21
 - bearing reference on radar, chart radar 2-24
 - context-sensitive menu on chart6-22
 - hiding on chart.....6-21
 - offsetting on radar, chart radar.....2-24
 - showing on chart.....6-21
- EBL OFFSET key.....2-24, 2-26
- EBL, VRM boxes.....6-12
- Echo area.....2-63
- Echo averaging2-8
- Echo color2-63
- Echo stretch2-8
- Echo-referenced speed.....3-2
- ENC charts
 - AIO display.....9-9
 - catalog of chart cells7-15
 - chart cell grouping.....7-17
 - chart cell status7-19
 - chart installation7-3
 - clearing.....7-32

- deleting..... 7-22
 - ENC coverage indication..... 7-23
 - ENC list export 7-11
 - ENC permit display 7-12
 - export list of..... 7-11
 - install/update history 7-14
 - license backup 7-12
 - license deletion 7-5
 - license installation, automatic 7-2
 - license installation, manual 7-3
 - license restore..... 7-12
 - manual updates..... 7-23
 - opening 7-19
 - permit status..... 7-13
 - publishers notes 7-22
 - reconverting 7-30
- F**
- Fallback arrangements..... 25-11
 - File export page 22-2
 - Filter status..... 16-10
 - Full user chart report 13-14
 - Full WPT report 12-29
- G**
- GAIN control..... 2-3
 - Gate-1
 - chart selection (for installation) 7-30
 - charts,licenses installation 7-31
 - license installation 7-31
 - General page 8-6
- H**
- Heading input..... 1-30, 6-29
 - Heading line 2-36
 - Head-up mode 2-18
 - Head-up TB mode..... 2-18
 - HL OFF key..... 2-36
- I**
- INDEX LINE key..... 2-31
 - Indications
 - chart display 1-14
 - chart radar display..... 1-13
 - radar display..... 1-11
 - Information box
 - nav data 2-42
 - nav data selection 2-44
 - route information 2-43
 - Instant access bar
 - chart display 6-6
 - radar, chart radar 1-17
 - Instant Track
 - parameters 21-4
 - Instant track
 - back to track..... 14-9
 - button label..... 14-13
 - details..... 14-11
 - messages 14-10
 - monitoring 14-11
 - safe off track..... 14-8
 - stopping monitoring 14-12
- Interference rejector** 2-7
- Interswitch** 2-47
- K**
- Keyboard test page 22-12
- L**
- Label report 13-16
 - Line report 13-15
 - Lost target alert 3-19
 - AIS 4-13
- M**
- Magnetron reset 2-55
 - Mains switch..... 1-6
 - Manual updates
 - deleting update symbols..... 7-25
 - inserting new update symbols..... 7-24
 - modifying existing update symbols..... 7-26
 - Mariner page 8-10
 - Mini conning display..... 24-11
 - MOB position..... 1-31
- N**
- Navigation data 16-8
 - Navtex
 - deleting messages 17-5
 - receiving messages..... 17-4
 - Noise rejector 2-11
 - North marker 2-36
 - North-up mode 2-19
 - Notes on radar, chart radar 2-70
- O**
- odometer resetting 6-36
 - Off center display (radar) 2-27
 - OFF CENTER key..... 2-27
 - Offset EBL
 - origin point..... 2-25
 - usage 2-24
 - Operating mode 6-16
 - Operator's manual..... 1-37
 - Optimize page 12-8, 12-18
 - Other sensors page..... 16-5
 - Overlay/NAV Tools box
 - anchor watch 15-10
 - check area page..... 15-7
 - PI (parallel index) page 15-1
 - predictor 15-9
 - ring 15-8
 - UKC..... 15-11
 - Overlay/Nav Tools box..... 6-12
 - Own ship functions box 6-10
 - Own ship marker 2-36
- P**
- Palette button 1-7
 - Parallel index lines
 - activating, deactivating 15-5

INDEX

- bearing reference 2-32, 15-5
- displaying 2-31
- erasing 2-31
- interval 15-6
- length adjustment 2-34, 15-7
- line interval 2-32
- line orientation 2-31
- mode 2-33, 15-5
- number of lines to display 15-5
- number to show 2-32
- orientation 15-6
- resetting 2-33, 15-6
- Passage plan report 12-30
- Past position display
 - AIS 4-13
 - TT 3-15
- Performance monitor 2-53
- Permanent warning box 6-12
- Permanent warnings
 - C-MAP charts 10-3
 - S57 charts 9-3
- Permit status 7-13
- PI (parallel index) page 15-1
- Position
 - alignment 16-13
 - primary and secondary 16-7
 - source 16-6
- Position events 19-2
- Position offset (radar) 1-32
- POSN page 16-4
- Power switch 1-6
- Predictor 2-39, 15-9
- Presentation library 9-7
- Presentation mode
 - chart 6-17
 - radar, chart radar 2-17
- Printing
 - cell status list 7-21
 - chart list 7-20
 - S57 chart object information 9-8
- Processor Unit EC-3000 1-5
- Program nos. 1-37
- Public key (ENC charts) 7-1
- Publishers notes 7-22
- Pulse length
 - changing 2-3
 - selection 2-2
- R**
- Radar Control Unit RCU-025 1-1
- Radar display indications 1-11
- Radar map
 - copying individual marks and lines 5-7
 - copying marks and lines in an area 5-7
 - copying marks and lines to another map file 5-8
 - erasing all marks and lines in a map file .. 5-6
 - erasing individual marks and lines 5-5
 - erasing marks and lines in an area 5-5
 - exporting 5-9
 - features on/off 5-13
 - hiding 5-1
 - importing 5-10
 - line entry 5-2
 - map comment 5-4
 - map points used 5-3
 - mark entry 5-2
 - radar map no. 5-4
 - route display 5-14
 - showing 5-1
- Radar overlay
 - errors in 15-3, 15-4
- Rain clutter adjustment
 - automatic 2-5
 - manual 2-6
- Range and bearing between two targets 2-26
- Range measurement
 - chart 6-21
 - radar 2-21
 - radar, chart radar 2-21
- Range selection 2-20
- Range/Presentation mode box 2-17
- Recording
 - chart usage log 19-8
 - danger targets log 19-9
 - details log 19-5
 - position events 19-2
 - user events 19-1
 - voyage log 19-6
- Reports
 - area 13-16
 - circle 13-16
 - clearing line 13-15
 - full user chart 13-14
 - Full WPT 12-29
 - label 13-16
 - line 13-15
 - passage plan 12-30
 - tidal 13-14
 - WPT table 12-28
- Ring page 15-8
- Route bank 12-16
- Route information box 6-11
- Route page 8-9
- Route transfer log 19-11
- Routes
 - adding waypoints at end of route 12-11
 - changing waypoint position 12-10
 - creating new 12-4
 - deleting 12-23
 - deleting waypoints 12-11
 - exporting FAR-3xx0 data 12-22
 - exporting FEA-2x07, csv, ASCII data... 12-22
 - full WPT report 12-29
 - importing csv, ASCII data 12-21
 - importing FEA-2x07 data 12-20
 - importing FMD-3xx0, FCR-2xx9 data... 12-20

- inserting waypoint 12-11
 - optimizing 12-18
 - overview in planning 12-1
 - passage plan report 12-30
 - route bank 12-16
 - SAR 12-13
 - selecting for monitoring 14-1
 - selecting route components to display .. 14-4
 - stopping monitoring 14-4
 - switching monitored to planning 14-7
 - transfer 12-24
 - user chart page (route planning) 12-7
 - Waypoints page (monitoring) 14-5
 - waypoints page (route planning) 12-6
 - WPT table 12-28
- S**
- S57 charts
 - chart legend 9-2
 - chart object information 9-8
 - chart update approval 9-6
 - display date 9-4
 - permanent warnings 9-3
 - presentation library 9-7
 - symbols used in 9-7
 - update review date 9-4
 - Safety contour 8-1, 11-2
 - Safety depth 8-1
 - SAR route 12-13
 - SART
 - introduction 2-60
 - receiving 2-60
 - Screen scroll in true motion mode 2-20
 - Screenshots
 - capturing screen 1-33
 - deleting 22-15
 - exporting 22-15
 - Screenshots page 22-14
 - Sea clutter adjustment
 - automatic 2-4
 - manual 2-4
 - Second-trace echoes 2-16
 - Self test page 22-5
 - Sensor information box 1-20, 6-9
 - Sensor information, datum box 1-20
 - Sensor set (system, local) 1-27
 - Sensors menu 16-2
 - Set and drift 3-16
 - Settings menu 1-33
 - accessing 22-1
 - CCRP 22-17
 - customize page 22-10
 - display test page 22-11
 - file export page 22-2
 - file import page 22-3
 - file maintenance page 22-4
 - keyboard test page 22-12
 - screenshots page 22-14
 - self test page 22-5
 - user default page 22-16
 - Shallow contour 8-1
 - Ship and route parameters 21-1
 - Shuttle ferry mode 2-64
 - SPD page 16-3
 - Speed input 1-28, 6-27
 - Split screen 6-24
 - Standard page 8-4
 - Static trial maneuver 3-20
 - Status bar
 - chart display 6-4
 - radar, chart radar 1-15
 - STBY TX button 2-1
 - Stern marker 2-36
- T**
- TARGET DATA key 4-8
 - Target list (TT, AIS) 3-12
 - TARGET LIST key 3-12
 - Targets page 8-11
 - Tidal report 13-14
 - Time 1-32
 - Tips 1-38, 6-24
 - Track
 - erasing 5-14
 - setup 5-13
 - Trackball Control Unit RCU-026 1-4
 - Trackball maintenance 25-4
 - Tracking page 8-7
 - TRAIL key 2-29
 - Trails
 - color 2-30
 - indications 2-28
 - level of afterglow 2-30
 - own ship?s 2-30
 - resetting 2-29
 - suppressing trails around own ship 2-30
 - trail stabilization in true motion 2-29
 - trail time 2-29
 - true or relative 2-28
 - Trial maneuver
 - dynamic trial 3-20
 - procedure 3-21
 - static trial 3-20
 - terminating 3-24
 - trip meter resetting 6-36
 - True motion mode 2-19
 - True motion reset 6-19
- TT**
- acquisition zone 3-4, 3-5
 - alert list 3-26
 - association 4-15, 18-10
 - automatic acquisition 3-3
 - automatic acquisition zone 3-4
 - CPA/TCPA alarm 3-17
 - data display 3-10
 - hiding 3-1
 - lost target alert 3-19
 - lost target alert filter (chart mode) 18-3

INDEX

- manual acquisition3-5
- past position display.....3-15
- past positions, attributes (chart mode)... 18-3
- pop-up info3-11
- showing3-1
- simulation mode.....3-25
- static trial maneuver.....3-20
- symbol brilliance.....3-8
- symbol color.....3-9
- symbol color (chart mode).....18-1
- symbol size (chart mode).....18-1
- symbols3-7
- symbols (chart mode).....18-1
- target data (chart mode).....18-2
- target list.....3-12
- terminating a trial maneuver.....3-24
- terminating tracking on target.....3-7
- trial maneuver3-20
- trial maneuver procedure3-21
- vector3-15
- TUNE button2-1
- Tuning
 - automatic.....2-1
 - initializing.....2-1
 - manual2-2
- U**
- UKC page
 - setting.....15-11
 - UKC window.....15-12
- UKC window15-12
- Undo12-5, 13-7
- User chart page
 - route planning12-7
- User charts
 - area report.....13-16
 - circle report13-16
 - clearing line report.....13-15
 - creating13-4
 - deleting.....13-13
 - deleting objects from.....13-9
 - editing objects on13-8
 - full report13-14
 - importing13-11
 - information in route monitoring.....14-6
 - label report13-16
 - line report13-15
 - notes13-6
 - route monitoring13-17
 - selecting objects to display13-10
 - tidal report13-14
- User default page.....22-16
- User events19-1
- User profiles1-33, 1-34
- V**
- VECTOR MODE key.....3-15
- VECTOR TIME key.....3-15
- Vectors
 - own ship2-37
 - target2-37
- Voyage log
 - conditions for logging19-8
 - viewing19-7
- VRM
 - context-sensitive menu on chart6-22
 - hiding on chart.....6-21
 - range measurement on chart.....6-21
 - range measurement on radar,
 - chart radar2-21
 - showing on chart.....6-21
- W**
- Watch alert2-41
- Wave data2-43
- Wave mode2-46
- Wave stabilization2-45
- Waypoints page
 - route monitoring14-5
 - route planning12-6
- Wind sensor16-13
- Wiper2-11
- WPT table report.....12-28, 12-29, 12-30
- Z**
- Zoom2-35

Declaration of Conformity



0560

We **FURUNO ELECTRIC CO., LTD.**

(Manufacturer)

9-52 Ashihara-Cho, Nishinomiya City, 662-8580, Hyogo, Japan

(Address)

declare under our sole responsibility that the product

MARINE RADAR

FAR-3210, FAR-3210-BB, FAR-3220, FAR-3220-BB, FAR-3220-NXT, FAR-3220-NXT-BB,
FAR-3230S, FAR-3230S-BB, FAR-3230S-SSD, FAR-3230S-SSD-BB, FAR-3220W-BB,
FAR-3230SW-BB, FAR-3310, FAR-3320, FAR-3320-NXT, FAR-3330S, FAR-3330S-SSD,
FAR-3320W and FAR-3330SW

(Serial No.4395/6313-xxxx)

(Model name, type number)

to which this declaration relates conforms to the following standard(s) or normative document(s)

IMO Resolution A.278(VIII), A.694(17)
IMO Resolution MSC.36(63), MSC.97(73)
IMO Resolution MSC.191(79), MSC.192(79)
IMO Resolution MSC.302(87)
IMO Resolution MSC.232(82) Appendix 6
IMO MSC.1/Circ.1349
ITU-R M.1177-4

IEC 60945 Ed. 4.0: 2002 incl. Corr. 1, 2008
IEC 61162-1 Ed. 5.0: 2016
IEC 61162-2 Ed. 1.0: 1998
IEC 61162-450 Ed. 1.0 A1: 2016
IEC 62288 Ed. 2.0: 2014
IEC 62388 Ed. 2.0: 2013
IEC 61174 Ed. 4.0: 2015 Annex F

(title and/or number and date of issue of the standard(s) or other normative document(s))

For assessment, see

- EC Type Examination (Module B) certificate No. MEDB00001BE Rev.6 issued by DNV GL AS (0575), Norway.
- Product Quality System (Module D) certificate No. P 112 (Issue 46) issued by Telefication, The Netherlands.

This declaration is issued according to the Directive 2014/90/EU of the European Parliament and of the Council on marine equipment, and the Implementing Regulation (EU) 2019/1397.

On behalf of Furuno Electric Co., Ltd.

Nishinomiya City, Japan
July 29, 2020

(Place and date of issue)

Yoshitaka Shogaki
Department General Manager
Quality Assurance Department

(name and signature or equivalent marking of authorized person)