

FURUNO

OPERATOR'S MANUAL

MARINE RADAR

FR-10

Model

FR-12



ECF

(Elemental Chlorine Free)

The paper used in this manual
is elemental chlorine free.

FURUNO ELECTRIC CO., LTD.

9-52 Ashihara-cho,
Nishinomiya, 662-8580, JAPAN

• FURUNO Authorized Distributor/Dealer

All rights reserved. Printed in Japan

Pub. No. OME-36870-B

(TEHI) FR-10/12

A : FEB. 2022

B : AUG. 22, 2022



0 0 0 1 9 9 0 7 4 1 2

IMPORTANT NOTICES

General

- This manual has been authored with simplified grammar, to meet the needs of international users.
- The operator of this equipment must read and follow the descriptions in this manual. Wrong operation or maintenance can void the warranty or cause injury.
- Do not copy any part of this manual without written permission from FURUNO.
- If this manual is lost or worn, contact your dealer about replacement.
- The contents of this manual and equipment specifications can change without notice.
- The example screens (or illustrations) shown in this manual can be different from the screens you see on your display. The screens you see depend on your system configuration and equipment settings.
- Save this manual for future reference.
- Any modification of the equipment (including software) by persons not authorized by FURUNO will void the warranty.
- The following concern acts as our importer in Europe, as defined in DECISION No 768/2008/EC.
 - Name: FURUNO EUROPE B.V.
 - Address: Siriusstraat 86, 5015 BT, Tilburg, The Netherlands
- The following concern acts as our importer in UK, as defined in SI 2016/1025 as amended SI 2019/470.
 - Name: FURUNO (UK) LTD.
 - Address: West Building Penner Road Havant Hampshire PO9 1QY, U.K.
- All brand, product names, trademarks, registered trademarks, and service marks belong to their respective holders.

How to discard this product

Discard this product according to local regulations for the disposal of industrial waste. For disposal in the USA, see the homepage of the Electronics Industries Alliance (<http://www.eiae.org/>) for the correct method of disposal.

How to discard a used battery

Some FURUNO products have a battery(ies). To see if your product has a battery, see the chapter on Maintenance. If a battery is used, tape the + and - terminals of the battery before disposal to prevent fire, heat generation caused by short circuit.

In the European Union

The crossed-out trash can symbol indicates that all types of batteries must not be discarded in standard trash, or at a trash site. Take the used batteries to a battery collection site according to your national legislation and the Batteries Directive 2006/66/EU.

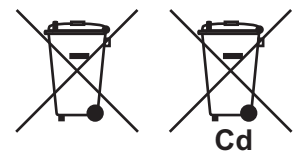

In the USA

The Mobius loop symbol (three chasing arrows) indicates that Ni-Cd and lead-acid rechargeable batteries must be recycled. Take the used batteries to a battery collection site according to local laws.

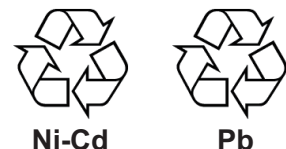

In the other countries

There are no international standards for the battery recycle symbol. The number of symbols can increase when the other countries make their own recycle symbols in the future.



SAFETY INSTRUCTIONS

Read these safety instructions before you operate or install the equipment.



WARNING

Indicates a condition that can cause death or serious injury if not avoided.



CAUTION

Indicates a condition that can cause minor or moderate injury if not avoided.



Warning, Caution



Prohibitive Action



Mandatory Action



WARNING



Do not open the equipment.

The equipment uses high voltage that can cause electrical shock. Refer any repair work to a qualified technician.



Before turning on the radar, be sure no one is near the antenna.

Prevent the potential risk of being struck by the rotating antenna, which can result in serious injury or death.



Do not disassemble or modify the equipment.

Fire, electrical shock or serious injury can result.



Do not place operate the equipment with wet hands.

Electrical shock can result.



Do not place liquid-filled containers on the equipment.

Fire or electrical shock can result if a liquid spills into the equipment.



If water leaks into the equipment or something is dropped into the equipment, immediately turn off the power at the switchboard.

Fire or electrical shock can result.



WARNING



Use the correct fuse.

Use of a wrong fuse can result in fire or damage to the equipment.



If the equipment is giving off smoke or fire, immediately turn off the power at the switchboard.

Fire or electrical shock can result.



CAUTION

Observe the following compass safe distances to prevent deviation of a magnetic compass.

Unit	Standard	Steering
FR-10	0.45 m	0.30 m
FR-12	0.65 m	0.40 m



Follow the instructions in this manual to ensure correct installation and connection with all related equipment.

CAUTION

 **The guard zone alarm and Risk Visualizer™ are effective aids to anti-collision.**

Using these functions does not relieve the operator of the responsibility to keep a vigilant watch on his or her surroundings.



CAUTION

 **The data presented by this equipment is intended as a source of navigation information.**

The prudent navigator never relies exclusively on any one source of navigation information, for safety of vessel and crew.

Target Tracking (TT) safety information

WARNING

 **The TT function is a valuable aid to navigation. However, the navigator must check all aids available to avoid collision.**

- The TT automatically tracks an automatically or manually acquired radar target and calculates its course and speed, indicating them with a vector. Since the data generated by the TT depends on the selected radar targets, the radar must be optimally tuned for use with the TT, to ensure required targets will not be lost or unnecessary targets, like sea returns and noise, will not be acquired and tracked.
- A target is not always a landmass, reef, ship, but can also be returns from the sea surface and from clutter. As the level of clutter changes with the environment, the operator must correctly adjust the sea and rain clutter controls and the gain control so that the target echoes do not disappear from the radar screen.

CAUTION

The plotting accuracy and response of this TT meets IMO standards. Tracking accuracy is affected by the following:

- Tracking accuracy is affected by course change. One to two minutes is required to restore vectors to full accuracy after an abrupt course change. (The actual amount depends on gyrocompass specifications.)
- The amount of tracking delay is inversely proportional to the relative speed of the target. Delay is approx. 15-30 seconds for the higher relative speed; approx. 30-60 seconds for the lower relative speed. The following factors can affect accuracy:
 - Echo intensity
 - Radar transmission pulse length
 - Radar bearing error
 - Heading sensor error
 - Course change (own ship and targets)

TFT display

The high quality TFT (Thin Film Transistor) LCD displays 99.99% of its picture elements. The remaining 0.01% may drop out or light. However, this is an inherent property of the TFT; it is not a sign of malfunction.

TABLE OF CONTENTS

FOREWORD	ix
SYSTEM CONFIGURATION	xi
EQUIPMENT LIST	xiii
1. INSTALLATION & WIRING	1-1
1.1 How to Install the Equipment	1-1
1.2 Wiring	1-4
1.2.1 Rear of the display unit	1-4
1.2.2 External buzzer connection	1-7
1.2.3 Operator fitness	1-8
1.3 Input Signal	1-8
1.3.1 NMEA I/O sentences	1-8
1.3.2 NMEA2000 PGN	1-8
1.4 Initial Settings	1-10
1.4.1 How to select language	1-10
1.4.2 Installation menu	1-12
1.4.3 How to set up main/sub radar displays	1-15
1.4.4 How to set up the File menu	1-17
1.4.5 How to change units of measurement	1-19
1.4.6 Advanced TT settings	1-19
1.4.7 SCX-20 settings	1-19
1.4.8 SCX-21 settings	1-20
2. OPERATION	2-1
2.1 Display Unit Controls	2-1
2.2 How to Turn the Radar On/Off	2-2
2.3 TX/Standby	2-2
2.4 Display Indications	2-3
2.5 How to Adjust Display Brilliance, Panel Dimmer	2-4
2.6 Menu Description	2-4
2.7 Display Modes	2-6
2.7.1 How to select the display mode	2-6
2.7.2 Description of display modes	2-7
2.8 How to Temporarily Erase the Heading Line	2-8
2.9 How to Select the Range Scale	2-9
2.10 How to Adjust the Gain (sensitivity)	2-9
2.11 How to Reduce the Sea Clutter	2-10
2.12 How to Reduce the Rain Clutter	2-11
2.13 Automatic Adjustments of Sea and Rain Clutters	2-13
2.14 Target Trails	2-14
2.14.1 Trail time	2-14
2.14.2 How to activate/deactivate target trail	2-14
2.14.3 Trail mode setting	2-15
2.14.4 Trail gradation	2-15
2.14.5 Trail color	2-16
2.14.6 Trail level	2-16
2.14.7 How to restart, stop the trails	2-16
2.14.8 Own ship trail	2-17
2.14.9 How to erase all trails	2-17
2.15 Cursor	2-18
2.16 How to Measure the Range to a Target	2-19

2.16.1	How to adjust range ring brilliance	2-20
2.16.2	How to measure the range with a VRM.....	2-20
2.16.3	How to select VRM unit.....	2-21
2.17	How to Measure the Bearing to a Target.....	2-21
2.17.1	How to measure the bearing with an EBL.....	2-21
2.17.2	EBL reference	2-22
2.18	How to Measure the Range and Bearing Between Two Targets	2-23
2.19	PI (Parallel Index) Lines	2-24
2.19.1	How to set the maximum number of lines to display	2-24
2.19.2	How to change the PI line orientation.....	2-24
2.19.3	How to change PI line bearing and interval.....	2-25
2.20	Tuning/Channel	2-25
2.20.1	Tuning mode (X-Class series, DRS4DL+).....	2-25
2.20.2	TX channel selection (Available only for the DRS-NXT series radar sensor)... 26	2-25
2.21	How to Select a Pulselength.....	2-26
2.22	Echo Stretch.....	2-27
2.23	Echo Average.....	2-28
2.24	Interference Rejector	2-29
2.25	Dynamic Range	2-29
2.26	Display-Curve	2-30
2.27	How to Erase the Low Level Echoes.....	2-30
2.28	Target Analyzer™	2-31
2.29	Target Analyzer™ Mode	2-32
2.30	RezBoost™	2-32
2.31	Custom Setup.....	2-33
2.31.1	About custom setup.....	2-33
2.31.2	Description of custom setup items	2-33
2.31.3	How to set custom setups	2-34
2.32	Target Alarm.....	2-35
2.32.1	How to set a target alarm zone	2-35
2.32.2	How to stop the audio alarm.....	2-36
2.32.3	How to select the alarm type	2-36
2.32.4	How to sleep a target alarm temporarily.....	2-37
2.32.5	How to deactivate a target alarm.....	2-37
2.32.6	How to select the target strength which triggers a target alarm	2-37
2.33	Watchman	2-38
2.34	How to Turn the Buzzer On/Off	2-39
2.35	Alert Status	2-39
2.36	Color Selections	2-40
2.36.1	Preset colors	2-40
2.36.2	Custom colors	2-40
2.36.3	Brill/Color menu	2-41
2.37	How to Off-center the Display.....	2-43
2.37.1	How to select the off-center mode.....	2-43
2.37.2	How to off-center the display	2-43
2.38	Zoom	2-44
2.38.1	Zoom reference	2-45
2.38.2	How to zoom	2-45
2.39	Echo Area.....	2-47
2.40	Display Menu.....	2-47
2.41	Navigation Data	2-48
2.42	How to Send the Target Position and Enter the Origin Mark.....	2-49
2.43	Waypoint Mark.....	2-50
2.44	Own Ship and Barge Mark	2-50
2.44.1	How to show the own ship mark.....	2-50

TABLE OF CONTENTS

2.44.2	How to show the barge mark	2-51
2.45	How to Program Function Keys (F1, F2 and F3 keys)	2-52
2.45.1	Function key operation.....	2-52
2.45.2	How to change a function key program.....	2-52
2.46	Initial Sub Menu	2-53
2.46.1	How to open the Initial sub menu.....	2-53
2.46.2	Description of Initial sub menu	2-54
2.47	Sector Blank.....	2-55
3.	HOW TO INTERPRET THE RADAR DISPLAY	3-1
3.1	General	3-1
3.1.1	Minimum and maximum ranges	3-1
3.1.2	Radar resolution.....	3-2
3.1.3	Bearing accuracy	3-3
3.1.4	Range measurement.....	3-3
3.2	False Echoes	3-3
3.2.1	Multiple echoes	3-3
3.2.2	Sidelobe echoes.....	3-4
3.2.3	Virtual image	3-4
3.2.4	Shadow sector	3-5
3.3	SART (Search and Rescue Transponder)	3-5
3.3.1	SART description	3-5
3.3.2	General remarks on receiving SART	3-6
3.4	RACON	3-6
4.	TT OPERATION	4-1
4.1	Precautions	4-1
4.2	Controls when Using TT Function.....	4-1
4.3	TT Display On/Off	4-2
4.4	TT Symbols.....	4-2
4.5	TT Symbol Color	4-3
4.6	How to Acquire and Track Targets.....	4-4
4.6.1	Manual acquisition	4-4
4.6.2	Automatic acquisition	4-5
4.7	How to Stop Tracking a TT	4-6
4.7.1	How to stop tracking a single target.....	4-6
4.7.2	How to stop tracking all targets	4-6
4.8	Lost Target.....	4-6
4.9	Vector Attributes.....	4-7
4.9.1	What is a vector?	4-7
4.9.2	Vector time and vector reference	4-7
4.9.3	Vector time link.....	4-8
4.9.4	Own ship vector	4-8
4.10	Past Position Display (target past position).....	4-9
4.11	TT Data	4-10
4.12	CPA/TCPA Alarm.....	4-11
4.13	Proximity Alarm	4-12
4.14	How to Use the Risk Visualizer™ Function	4-13
4.14.1	How to set up the Risk Visualizer™ display	4-14
4.14.2	Risk Visualizer™ alerts.....	4-16
5.	AIS OPERATION	5-1
5.1	AIS Display On/Off.....	5-1
5.2	AIS Symbols.....	5-2
5.3	Activating, Sleeping Targets	5-3
5.4	AIS Target Data	5-4

5.5	How to Sort Targets.....	5-4
5.6	Display Range	5-5
5.7	How to Display the Targets within a Specific Sector	5-5
5.8	Number of Targets to Display.....	5-6
5.9	Vector Attributes	5-6
5.9.1	What is a vector?.....	5-6
5.9.2	Vector time and vector reference	5-6
5.10	Past Position Display (target past position).....	5-7
5.11	CPA/TCPA Alarm	5-7
5.12	Proximity Alarm	5-8
5.13	Lost Target	5-8
5.14	Symbol Color	5-9
5.15	How to Ignore Slow Targets	5-9
5.16	How to Show, Hide the Ship Names	5-9
5.17	How to Customize AIS.....	5-9
5.18	How to Customize Fishing Vessel's Symbol	5-11
5.19	How to Use the Risk Visualizer™ function	5-11
6.	RADIO OPERATION	6-1
6.1	Radio Display On/Off.....	6-1
6.2	Symbol Color	6-1
6.3	Past Position Display.....	6-2
6.4	Past Position Interval.....	6-2
6.5	How to Erase Target Tracks.....	6-3
7.	CHART OVERLAY	7-1
7.1	How to Show, Hide the Chart Display	7-1
7.2	How to Emphasize Land.....	7-2
7.3	How to Select Chart Type.....	7-2
7.4	Chart Settings.....	7-3
7.5	Depth Line	7-4
7.6	Depth Line Range.....	7-5
7.7	Chart Align.....	7-5
7.8	Cursor L/L Align.....	7-6
7.9	L/L Grid.....	7-6
7.10	Display Scroll.....	7-7
7.11	Display Ext Marks.....	7-7
8.	MAINTENANCE, TROUBLESHOOTING	8-1
8.1	Preventive Maintenance	8-1
8.2	Fuse Replacement	8-2
8.3	Simple Troubleshooting.....	8-2
8.4	Advanced-level Troubleshooting	8-3
8.5	Diagnostic Tests	8-4
8.6	LCD Test	8-5
8.7	RP Unit Test	8-6
8.8	Radar Sensor Test	8-7
8.9	Chart Administration	8-8
8.9.1	How to install charts	8-8
8.9.2	How to update charts	8-10
APPX. 1	MENU TREE	AP-1
APPX. 2	GEODETIC CHART LIST	AP-7
APPX. 3	DIGITAL INTERFACE	AP-9
APPX. 4	RADIO REGULATORY INFORMATION	AP-16

TABLE OF CONTENTS

APPX. 5 ALERT LIST.....	AP-17
SPECIFICATIONS	SP-1
PACKING LISTS.....	A-1
OUTLINE DRAWINGS.....	D-1
INTERCONNECTION DIAGRAMS.....	S-1
INDEX.....	IN-1

FOREWORD

A Word to the Owner of the FR-10/FR-12 Marine Radar

Congratulations on your choice of the FURUNO FR-10/FR-12 Marine Radar. We are confident you will see why the FURUNO name has become synonymous with quality and reliability.

Since 1948, FURUNO Electric Company has enjoyed an enviable reputation for innovative and dependable marine electronics equipment. This dedication to excellence is furthered by our extensive global network of agents and dealers.

Your equipment is designed and constructed to meet the rigorous demands of the marine environment. However, no machine can perform its intended function unless properly installed and maintained. Please carefully read and follow the operation and maintenance procedures set forth in this manual.

We would appreciate feedback from you, the end-user, about whether we are achieving our purposes.

Thank you for considering and purchasing FURUNO equipment.

Features

The main features are as shown below.

- Easy operation with keys, knobs and cursorpad.
- Echo area display with full screen provides observation of a wider range around the vessel.
- User-programmable function keys.
- AIS data available with connection of FURUNO AIS Transponder/Receiver.
- Customize AIS symbol available.
- Fast Target Tracking™ feature.
- Risk Visualizer™ feature helps determine potential navigational risks and reduce human error.
- Target Analyzer™ feature helps distinguish targets from heavy rain or snow (available only the DRS-NXT series radar sensor is connected).
- Overlay of FR-12 radar echo and chart is available (only when the RP unit is connected).
- Supports connection of sub display via LAN (independent control of video settings and TT for main and sub display).
- Supports mark and line transfer display from GP-3700/F (optional feature for FR-12)..

Program numbers

MAIN Application: 0359522-01.**

RP Application: 0359530-01.**

**=Minor modification

About the programs used in FR-12 Chart radars (with RP board installed)

- Ubiquitous QuickBoot Copyright© 2015. Ubiquitous Corp. All right reserved.
- Portions of this software are copyright© 2016. The FreeType Project (www.freetype.org). All right reserved.
- This equipment includes GPL2.0, LGPL2.0, Apache, BSD, MIT or other licensed software. For further software information, please access the following URL: https://www.furuno.co.jp/en/contact/cnt_oss_e01.html

Conventions used in this manual

- Keys and controls are shown in boldface type. For example, the **MENU** key.
- Menu names and menu items are put in brackets. For example, the [Echo] menu.
- To select a menu, menu item or option, you press the ▲ or ▼ symbol on the cursorpad. For the sake of brevity, we substitute “select” when it is necessary to use those symbols on the cursorpad. For example, “Push ▲ or ▼ on the cursorpad to select [Echo Stretch]...” is written in the manual as “Select [Echo Stretch]...”.

Note on Chinese font

The Chinese font used in this equipment is China Electronics Standardization Institute (CESI) bit-map font.

CE declaration

With regards to CE declarations, please refer to our website (www.furuno.com) for further information about RoHS conformity declarations.

Disclosure of Information about China RoHS

With regards to China RoHS information for our products, please refer to our website (www.furuno.com).

SYSTEM CONFIGURATION

Basic configuration is shown below with solid line.

²: 12 VDC battery can be used with the following configurations only.

DRS4D-NXT/DRS4D XClass/DRS4DL+: Up to 10 m antenna cable.

DRS6A-NXT: Up to 10 m antenna cable and the antenna length is 3.4 ft or 4 ft.

DRS Series Antenna Unit^{*1}
 DRS4D/6A/12A/25A X-Class,
 DRS2D/4D/6A/12A/25A-NXT,
 DRS4DL+

^{*1}: Up to two antenna units can be connected to the same network.

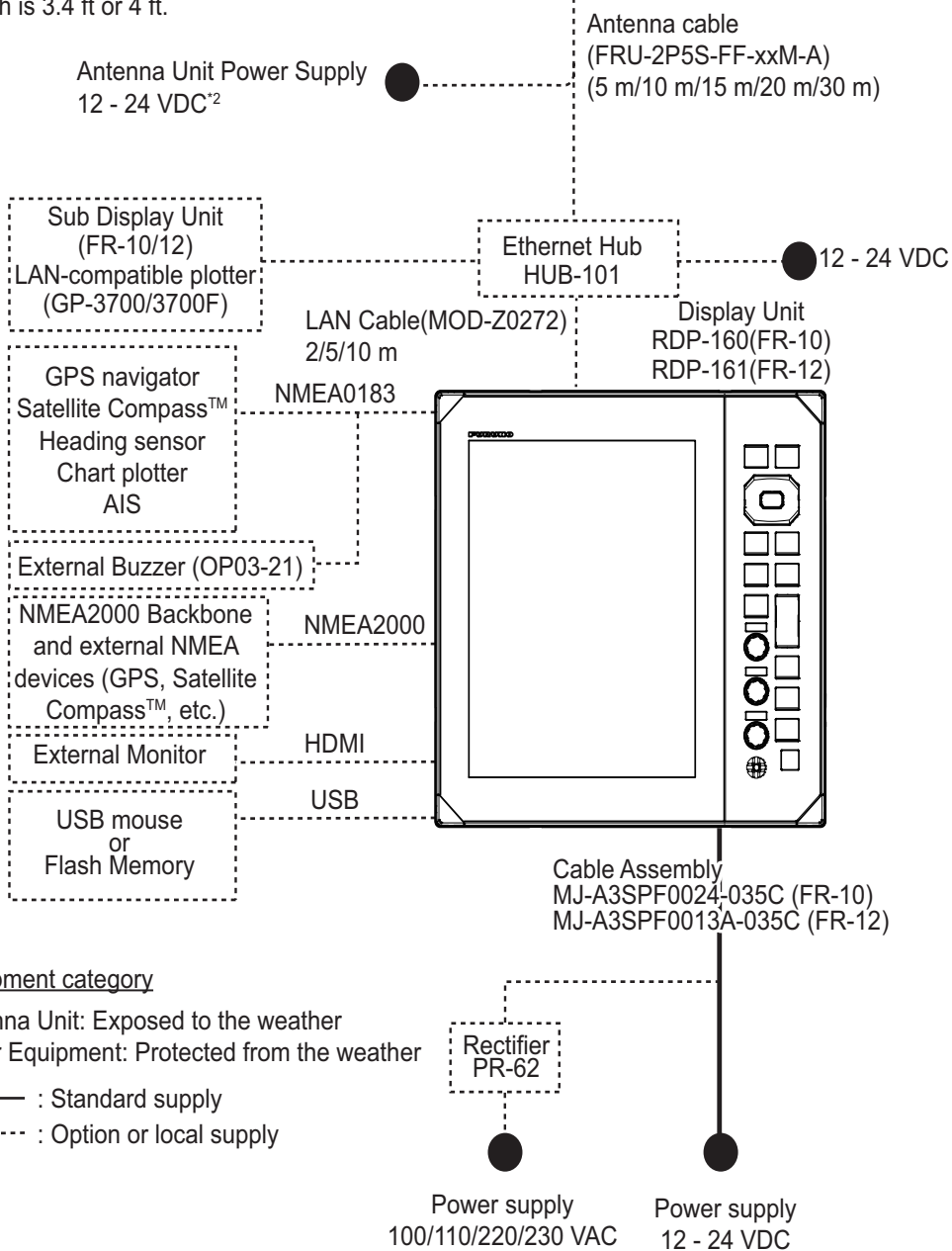

SYSTEM CONFIGURATION

²: 12 VDC battery can be used with the following configurations only.

DRS4D-NXT/DRS4D XClass/DRS4DL+: Up to 10 m antenna cable.
 DRS6A-NXT: Up to 10 m antenna cable and the antenna length is 3.4 ft or 4 ft.

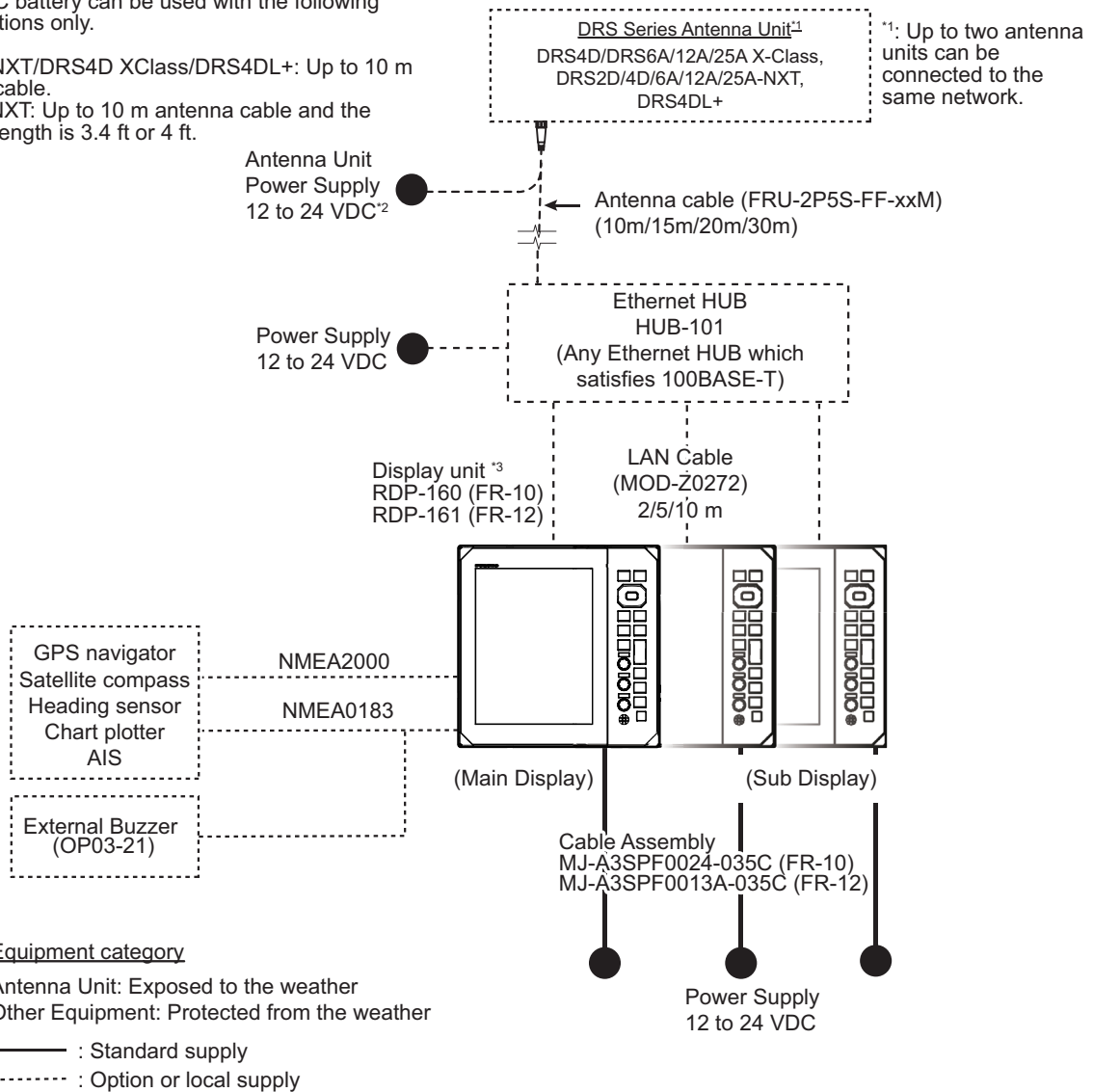

³: Up to three display units can be connected to an antenna unit.
 NMEA0183 signals from external sensors need to be input to main display unit and distributed to other display units.
 Connect one of the display units to output NMEA0183 sentence to the external sensors.

System Configuration for connecting sub display units

EQUIPMENT LIST

Standard supply (FR-10)

Name	Type	Code No.	Qty	Remarks
Display Unit	RDP-160	—	1	
Power Cable	MJ-A3SPF0024-035C	—	1	
Installation Materials	CP03-40300	000-038-470	1	
Spare Parts	SP03-20601	001-613-100	1	
Accessories	FP03-13001	001-613-160	1	

Standard supply (FR-12)

Name	Type	Code No.	Qty	Remarks
Display Unit	RDP-161	—	1	
Installation Materials	CP03-40400	000-038-472	1	
Spare Parts	SP03-20701	001-613-110	1	
Accessories	FP03-13101	001-613-170		

Optional supply (FR-10 & FR-12)

Name	Type	Code No.	Remarks
Chart Kit	OP03-266	001-613-190	For FR-12 with chart functionality only
Ethernet HUB	HUB-101	000-011-762	Required when connecting multiple display units to one antenna unit
External Alarm Buzzer	OP03-21	000-030-097	
6-pin Connector	OP03-221	001-184-670	
7-pin Connector	OP03-222	001-184-690	
Rectifier	PR-62	—	For 100/110/220/230 VAC
Cable Assembly (NMEA0183)	MJ-A6SPF0012-050C	000-154-053-10	5 m cable
	MJ-A6SPF0012-100C	001-596-070	10 m cable
	MJ-A6SPF0012-150C	000-161-513-10	15 m cable
	MJ-A6SPF0003-020C	000-154-029-10	2 m cable
	MJ-A6SPF0003-050C	000-154-054-10	5 m cable
	MJ-A6SPF0003-100C	000-168-924-10	10 m cable
	MJ-A6SPF0003-150C	001-596-080	15 m cable
	MJ-A7SPF0003-050C	000-159-688-10	5 m cable
Cable Assembly (NMEA2000)	FRU-NMEA-PMMFF-010	001-533-060	1 m cable
	FRU-NMEA-PMMFF-020	001-533-070	2 m cable
	FRU-NMEA-PMMFF-060	001-533-080	6 m cable
	FRU-NMEA-PFF-010	001-507-010	1 m cable
	FRU-NMEA-PFF-020	001-507-030	2 m cable
	FRU-NMEA-PFF-060	001-507-040	6 m cable
	CB-05PM+05BF-010	000-167-968-10	1 m cable
	CB-05PM+05BF-020	000-167-969-10	2 m cable
	CB-05PM+05BF-060	000-167-970-10	6 m cable

EQUIPMENT LIST

Name	Type	Code No.	Remarks
Cable Assembly (NMEA2000)	CB-05BFFM-010	000-167-971-10	1 m cable
	CB-05BFFM-020	000-167-972-10	2 m cable
	CB-05BFFM-060	000-167-973-10	6 m cable
NMEA2000 Connectors	FRUMM1MF1MF1001	001-507-050	Micro T connector
	NC-050505-FMF-TS001	000-160-507-10	Mini T connector
	FRU-MM1000000001	001-507-070	Micro termination resistor (M)
	FRU-MF00000001	001-507-060	Micro termination resistor (F)
	LTWMN-05AMMT-SL8001	000-160-508-10	Mini termination resistor (M)
	LTWMN-05AFFT-SL8001	000-160-509-10	Mini termination resistor (F)
	FRU-0505-FF-IS	001-077-830-10	Mini bulkhead feed-through
Front Fixing Panel Kit	OP03-269	001-630-420	For FR-10
	OP03-270	001-630-450	For FR-12

1. INSTALLATION & WIRING

1.1 How to Install the Equipment

Display unit

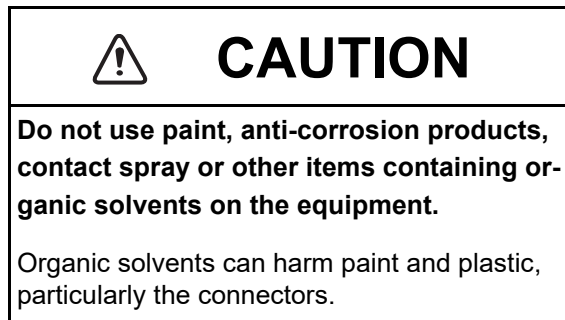

The display unit can be installed on a desktop or flush mounted in a console. Do not install the unit on the overhead or a bulkhead. Select a suitable location for the unit considering the following points:

- Select a location where the controls can be easily operated.
- Locate the unit away from the direct wind from air conditioners.
- The temperature range in the mounting location should be -15°C to 55°C (5°F to 55°F).
- Locate the unit away from devices that emit active gas.
- The mounting location must be well ventilated.
- Select a location where vibration and shock are minimal.
- A magnetic compass will be affected if the display unit is placed too close to the compass. Observe the compass safe distances in the safety instructions to prevent interference to the compass.
- Locate the unit away from direct sunlight to prevent heat build up inside the cabinet and condensation in the display.
- Keep the unit away from water and water splash. (The unit complies with the following waterproofing specifications. Front: IP55; Rear: IP22.)

1. INSTALLATION & WIRING

Desktop mount

The hanger is pre-attached to the display unit. For dimensions and required space for maintenance/service, see the outline drawing at the back of this manual.

1. Loosen the knob and remove the hanger.

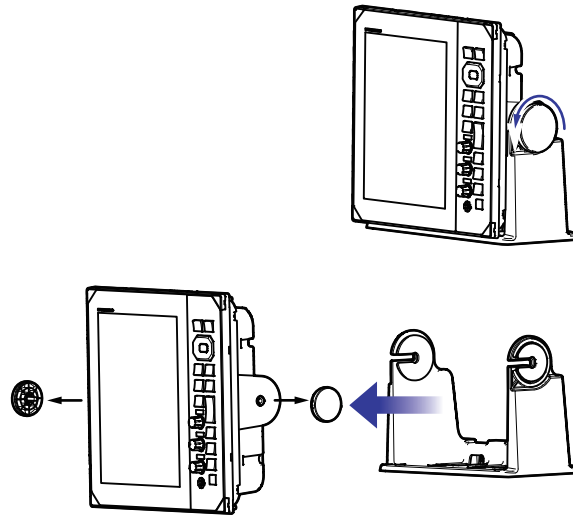

2. Fix the hanger assembly to a desktop with four self-tapping screws (5 × 20, supplied).

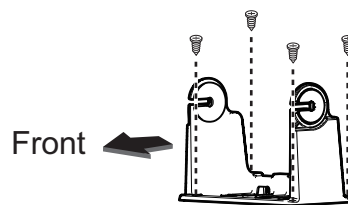

3. Set the display unit to the hanger assembly.

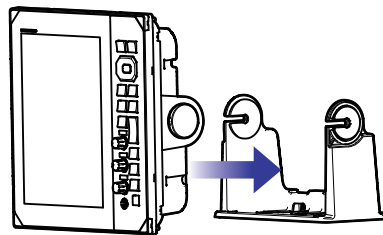

4. Loosely screw the knobs into either side of the hanger assembly.
5. Adjust the angle of the display unit for a comfortable viewing angle.
Note: Do not tilt the unit backward or forward for more than 65°. Cable connectors may be damaged if they contact the bracket.
6. Tighten the knobs on either side of the display unit.

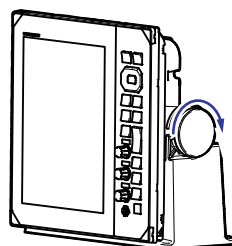

7. Attach the hard cover to the display unit.

Flush mount

The flush mount kit is required to mount the unit in a console/bulkhead. Select a flat mounting location, and install the unit as shown below.

Note 1: It is recommended to set up a dedicated breaker when flush mounting the unit, since it will be difficult to disconnect cables after the unit is installed.

Note 2: Wiring and connection before setting the unit into the mounting location is recommended.

1. Using the supplied template, make a cutout and drill four pilot holes in the mounting location.
2. Place the display unit on a flat, clean, soft area, then set the supplied flush mounting sponge to the display unit.

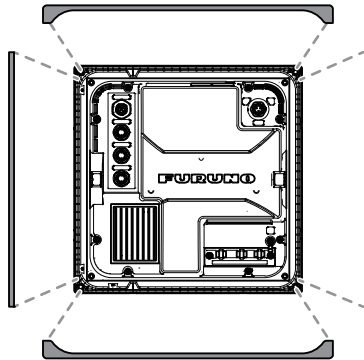

3. Set the display unit to the cutout.

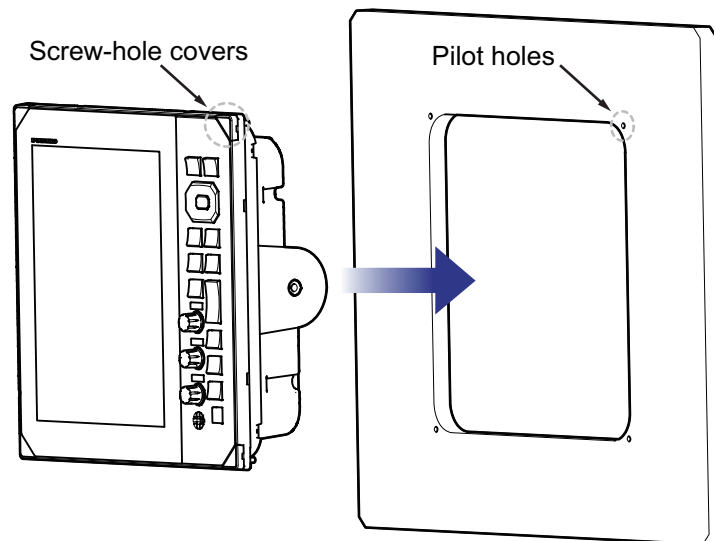

4. Open the four screw covers (on each corner of the unit face), then fasten the four supplied screws to secure the unit in place.
5. Attach the screw cover back into place.

Front Fixing

The optional front fixing panel kit (FR-10: OP03-269, FR-12: OP03-270) can be used to screw-fasten the display unit to the cutout from the front. Refer to the outline drawings and flush mounting template at the end of this manual.

1.2 Wiring

1.2.1 Rear of the display unit

All cables are connected at the rear of the display unit.

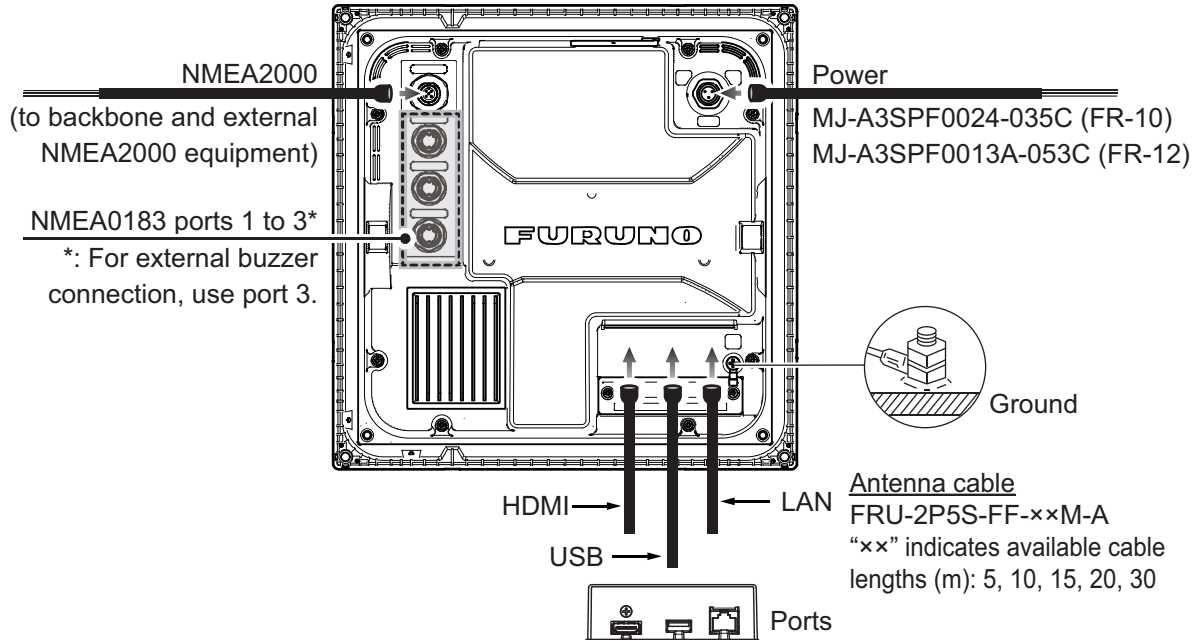

Note 1: Cut unused wires and wrap them with vinyl tape to keep them from touching one another.

Note 2: Use care when disconnecting cables to prevent damage to their connectors.

Note 3: Do not shorten the supplied cable.

Note 4: When connecting the HDMI, USB and LAN cable, use two cable ties to fix them to the fixing plate (see figure below).

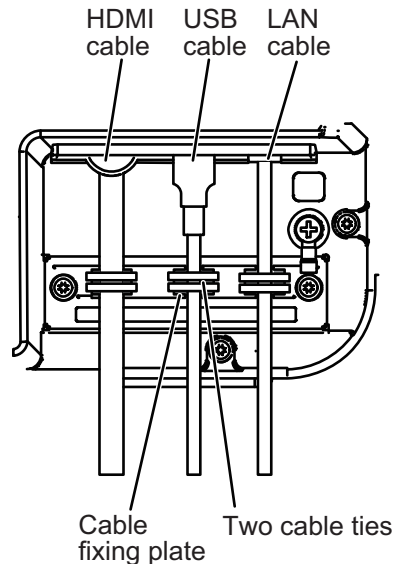

MJ-A6SPF pin assignments (NMEA0183-1/2)

Connector		Color	Remarks
1	TD1/2-A	White	NMEA0183
2	TD1/2-B	Black	
3	RD1/2-H	Yellow	
4	RD1/2-C	Green	
5	GND		
6	GND	Drain Wire	

MJ-A7SPF pin assignments (NMEA0183-3)

Connector		Color	Remarks
1	TD3-A	White	NMEA0183
2	TD3-B	Black	
3	RD3-H	Yellow	
4	RD3-C	Green	
5	EXT-BUZZER 12V	Red	Ext buzzer or Operator fitness
6	EXT-BUZZER	Blue	
7	GND	Drain Wire	

NMEA2000 pin assignments

Connector		Color	Remarks
1	SHIELD	Drain Wire	
2	NET_S	Red	
3	NET_C	Black	
4	NET_H	White	
5	NET_L	Blue	

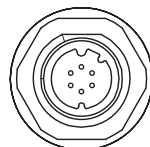

NMEA1/2

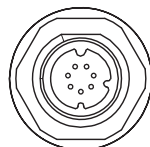

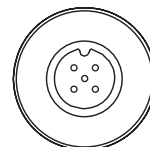

NMEA3



NMEA2000



Ground

	<h2>CAUTION</h2>
	<p>Do not fail to ground the display unit.</p> <p>If the ground is poor or there is no ground, the radar and other equipment may pick up interference.</p>

Grounding guidelines:

- The ground wire (local supply) should be 2sq or higher.
- The length of the ground wire should be as short as possible.

1. INSTALLATION & WIRING

- For an FRP vessel, fasten a 20 cm × 30 cm earthing plate to the outside of the boat's hull and attach the ground wire to a bolt on the plate.
- Attach a closed-end lug () to the ground wire. Do not use an open-end lug ().
- External equipment whose signal line is connected to ground cannot be directly connected to this equipment if the positive polarity of the vessel's DC power is connected to ground.

How to connect the display unit to the power supply

Connect the cable assembly to the power supply (12 - 24 VDC) as shown below.

- **White cable:** Connect to the positive (+) terminal.
- **Black cable:** Connect to the negative (-) terminal.
- **Drain wire:** Connect to distribution panel for grounding. Cover with heat shrink tubing and attach the crimp-on lug to connect.

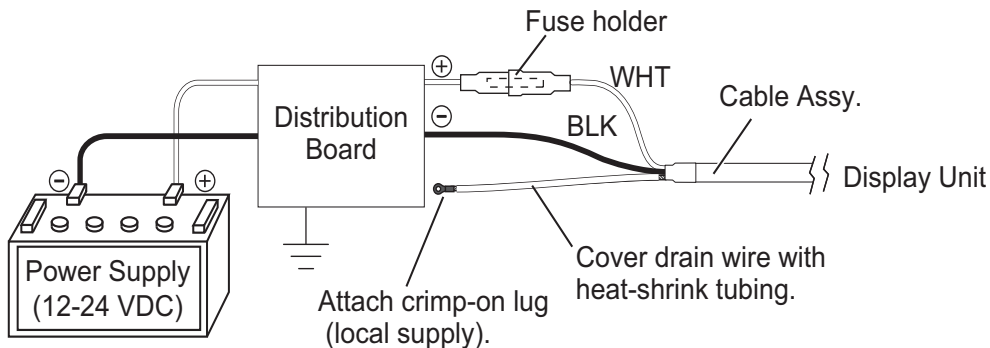

Note 1: This equipment cannot be used with a power supply whose voltage is greater than 24 VDC.

Note 2: If necessary change the fuse in cable assembly to match the power voltage.

For connecting sub display units

When connecting sub display units, refer to the "SYSTEM CONFIGURATION" on page xi and xi. Connect the LAN cable to the LAN port. See the interconnection diagram at the back of this manual for details. Leave slack in the cable to ease maintenance.

Check the following points when connecting other display units.

- Up to three display units can be connected to one radar sensor.
- One of the display unit must be set as the main display unit.
- NMEA2000/NMEA0183 signals need to be input to main display unit and distributed to other display units via HUB-101.
- The NMEA2000/NMEA0183 signal from the external sensor must be input to the main display. Data shared over LAN via the main display has priority over the NMEA2000/NMEA0183 signal input to the sub display.

Note: Do not connect FR-10/12 to the NavNet series network.

For connecting external display units

By connecting an external monitor to the HDMI port, you can view the same video as this unit from an external monitor. The orientation, resolution, and aspect ratio of the display screen are the same as the main unit (FR-10: SVGA, 800x600, 56Hz, FR-12: XGA, 1024x768, 60Hz).

Note: When a landscape monitor is connected, it is displayed rotated 90° counter-clockwise. Rotate the monitor 90° clockwise so that the left side of the screen is on top and fix it.

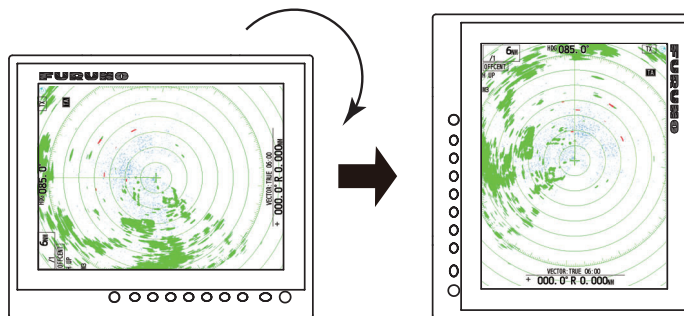

1.2.2 External buzzer connection

External buzzer

The external buzzer alerts you when targets violate the guard zone set. Connect the buzzer to the NMEA3 port as shown below, using the external buzzer installation kit.

External Buzzer Installation Kit

Type: OP03-21, Code No.: 000-030-097

	Name	Type	Code No.	Qty	Remarks
1	Buzzer	PKB42SWH2940	000-153-221-10	1	Connector at both ends
2	Cable Tie	CV-70N	000-162-185-10	5	
3	Heat Shrink Tube	3×0.25 BLK	—	1	
4	Double-sided Tape	25×25×T0.91MM	000-173-188-10	1	25 m×25 mm

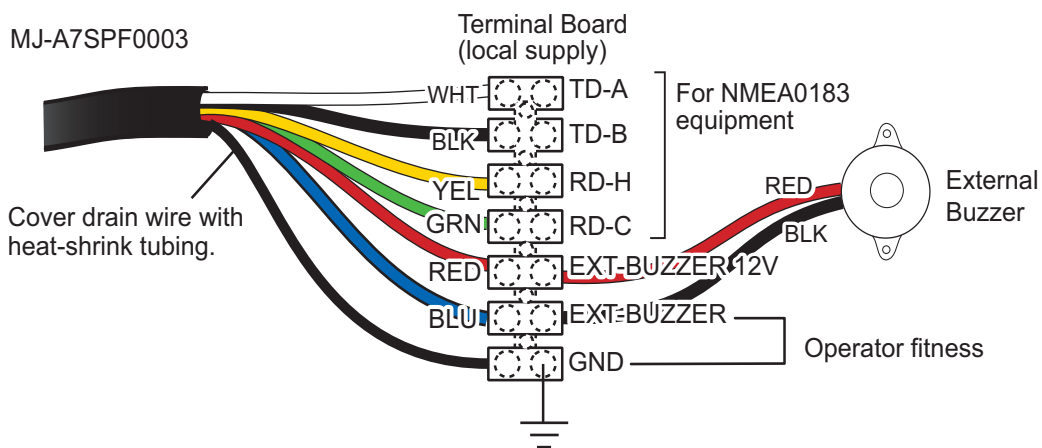

1. INSTALLATION & WIRING

1.2.3 Operator fitness

When outputting the operator fitness sentence, use the above port for the external buzzer. Select [System Installation]-[Alert Out Type]-[Operator Fitness] (See section 1.4.2).

1.3 Input Signal

This radar accepts input signals in NMEA format. Three NMEA ports are provided for input signals, and the method of sentence handling is common to all ports.

1.3.1 NMEA I/O sentences

NMEA1/NMEA2/NMEA3 Input Sentence

- Baud rate: 4800/38400
- NMEA 0183 (IEC 61162-2)

Sentence	Description
BWC	Bearing and distance to waypoint-Great Circle
BWR	Bearing and distance to waypoint - Rhumb Line
GGA	Global Positioning System Fix Data
GLL	Geographic Position
GNS	GNSS Fix Data
HDG	Heading, Deviation & Variation
HDM	Heading, Magnetic
HDT	Heading True
RMB	Recommended Minimum Specific Navigation Information
RMC	Recommended Minimum Specific GNSS Data
THS	True Heading and Status
TTM	Tracked Target Message
VDM	VHF Data-link Message
VDO	AIS VHF Data-link Message
VHW	Water Speed and Heading
VTG	Course Over Ground & Ground Speed
ZDA	Time & Date

NMEA1/NMEA2/NMEA3 Output Sentence

Sentence	Description
RSD	Radar System Data
TLL	Target Latitude and Longitude
TTM	Tracked Target Message

1.3.2 NMEA2000 PGN

Input PGN

PGN	Description
059392	ISO Acknowledgment
059904	ISO Request
060160	ISO Transport Protocol, Data Transfer

PGN	Description
060416	ISO Transport Protocol, ConnectionManagement -BAM group function
060928	ISO Address Claim
061184	Self test Group Function
065240	ISO Commanded Address
126208	NMEA-Request Group Function
	NMEA-Command Group Function
	NMEA-Acknowledge Group Function
126720	Memory Clear Group Function
	Reset Group Function
	GMM Message
126992	System Time
126996	Product Information
127250	Vessel Heading
127258	Magnetic Variation
128259	Speed
129025	Position, Rapid Update
129026	COG & SOG, Rapid Update
129029	GNSS Position Data
129033	Local Time Offset
129538	GNSS Control Status
130577	Direction Data
130816	Self Test Report
130818	Heading and Attitude Sensor Control status
130822	Unit Division Code

Output PGN

PGN	Description	Remarks
059392	ISO Acknowledgment	For refusing output requirement
059904	ISO Request	For requiring output
060160	ISO Transport Protocol, Data Transfer	
060416	ISO Transport Protocol, ConnectionManagement -BAM group function	
060928	ISO Address Claim	<ul style="list-style-type: none"> • Address autonomy • Receiving output requirement
061184	Self Test Group Function	
126208	NMEA-Request group function	<ul style="list-style-type: none"> • Address autonomy • Receiving output requirement
	NMEA-Command group function	Changing the setting of other equipment
	NMEA-Acknowledge group function	Sending the confirmation for NMEA-Request group function and NMEA-Command group function
126464	PGN List-Transmit PGN's group function	Receiving output requirement
	PGN List-Received PGN's group function	Receiving output requirement
126720	Memory Clear Group Function	
	Reset Group Function	
	GMM Message	

PGN	Description	Remarks
126993	Heartbeat	
126996	Product Information	Receiving output requirement

1.4 Initial Settings

Many of the procedures covered in this section require access to the following protected menus.

- Units menu
- SCX-21 menu
- TT Advanced menu
- Installation menu
- SCX-20 menu
- Factory menu

To operate the menus, Press the MENU key to show menu window, and then press the MENU key five times while pressing down the **CANCEL/HL OFF** key. Further, to prevent unintended changes to these settings, always restart the system after changes are made. Restarting the system will re-apply the menu protection.

1.4.1 How to select language

Language selection at initial start up

At the first power on after installation or whenever the memory is cleared, the language selection screen appears. Select your language as shown below. The default language is English.

1. Press the (ϕ /BRILL) key on the display unit to turn on the power. The splash screen appears followed by the language selection screen.

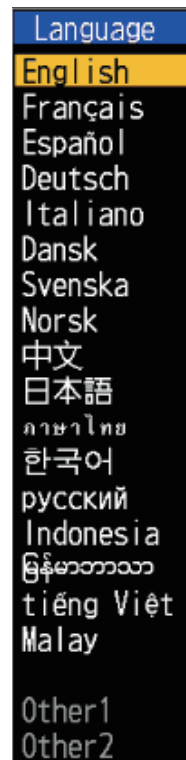
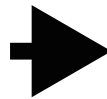

2. Operate the cursorpad (▲ or ▼) to select the language of your choice then press the **ENTER** key. A confirmation message appears.
3. Push ▲ on the cursorpad to select [Yes] then press the **ENTER** key.
Initializing screen appears.

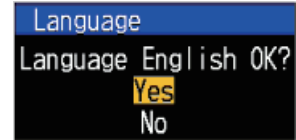

Language selection from the menu

1. Press the (⏻ /BRILL) key on the display unit to turn on the power.
2. Press the **MENU** key to show the menu.
3. Access the [Factory] menu.

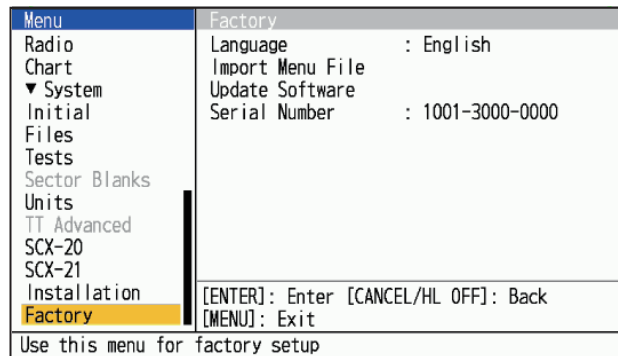

4. Select [Language], then press the **ENTER** key.



5. Select your language, then press the **ENTER** key.
6. Press the **MENU** key to close the menu.
Display unit automatically reboots.

1.4.2 Installation menu

1. Press the **MENU** key to show the menu.
2. Access the [Installation] menu.

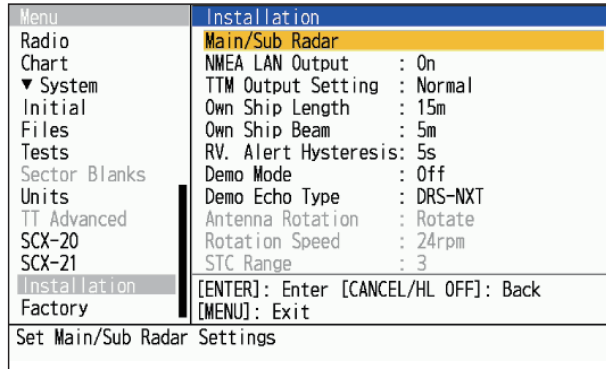

3. Select the menu item to set, then press the **ENTER** key.
4. Select the option required, then press the **ENTER** key.
5. After setting all menu items, press the **MENU** key to close the menu.

Description of Installation menu items

Note: For details regarding connection and cables required for connection with the radar sensor, see the radar sensor’s installation manual.

- **[Main/Sub Radar]:** Set up the FR-10/12 display units as main or sub. See section 1.4.3 for details.
- **[NMEA LAN Output]:** Enable/disable the output of NMEA sentences to the LAN network (only for main display). When there are two antennas, set the LAN output of the second main display unit to Off.
- **[TTM Output Setting]:** Set the output format for TTM sentences. Select [Normal] for output to external equipment using NMEA0183 V4.1 or later. Select [Legacy] for external equipment using serial input.
 [Normal]: Output "TT number: 01-99, 100" as "TTM: 01-99, 00".
 [Legacy]: Output "TT number: 01-99, 100" as "TTM: 01-99, 100".
- **[Own Ship Length]:** Set the length of your vessel. This is normally completed at installation.
- **[Own Ship Beam]:** Set the beam (width) of your vessel. This is normally completed at installation.
- **[RV. Alert Hysteresis]:** Sets the history effect duration of the Risk Visualizer.
- **[Demo Mode]:** Normally, set to [Off]. To view simulated radar data, select [Internal]. If a USB flash memory containing compatible radar data is connected, the USB data is automatically selected for demonstration.
- **[Demo Echo Type]:** Select the type of radar antenna to use for the simulation. This selection is only applied if [Demo Mode] is set to [On] and only affects the demonstration.

Note: When [DRS X-Class] is selected, the demo echo (normal echo) of DRS X-Class is displayed. When [DRS-NXT] is selected, the demo echo of the DRS-NXT target analyzer is shown (For NXT, the Target Analyzer echo is fixed instead of the normal echo).

- **[Antenna Rotation]:** Select [Rotate] to rotate the antenna and transmit radar pulses. The [Stop] setting, which transmits radar pulses without rotating the antenna, is for use by the service technician.
- **[Rotation Speed]:** Set the rotation speed of the antenna unit. Unavailable with the DRS4DL+.
- **[STC Range]:** Set the range from which Near STC (Sensitivity Time Control) is applied. Unavailable with the DRS4DL+.
- **[Near STC Level]:** Set the STC level. Sets the slope of the STC curve for short distances, from 1 to 4, where the slope becomes steeper and closer clutter is suppressed to a greater extent.
- **[A/C Auto Adjust]:** Set the amount of adjustment to be automatically applied to the anti-clutter features (A/C Rain and A/C Sea). This adjustment is applied before the operator's adjustments. Unavailable with the DRS4DL+/DRS-NXT series.
- **[Heading Alignment]:** Ensure you have installed the antenna unit correctly, so that the unit faces towards the bow of the ship. A target at the front of the ship, aligned with the bow, must appear on the heading line (zero degrees). If the target does not appear on the heading line, follow the procedure below to adjust the heading.
 1. Set ship heading toward an acceptable target (for example, ship at anchor or buoy) at a range between 0.125 and 0.25 nautical mile.
 2. Transmit the radar at the range of 0.25 nautical mile and measure the bearing of that target relative to ship heading with an EBL.
 3. Open the [Installation] menu and select [Heading Alignment].
 4. Press the **ENTER** key to show the heading adjustment window.
 5. Press **▲** or **▼** to set the value measured at the above step 2. Check that the target appears on the heading line.

Note: Increasing the value causes the echo to move counterclockwise. Decreasing the value causes the echo to move clockwise.
 6. Press the **ENTER** key to finish.
- **[Sweep Timing]:** Although the radar sensor connected to the unit does not generally require timing adjustments, fine adjustments can be made if a target that should be displayed as a straight line is displayed as shown below.

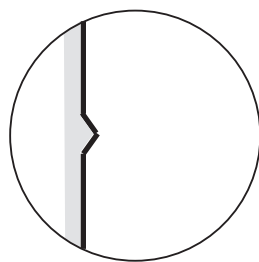

(1) Target pulled

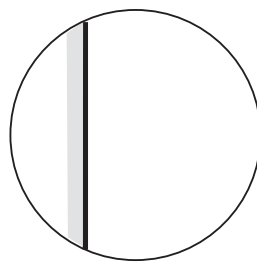

(2) Correct

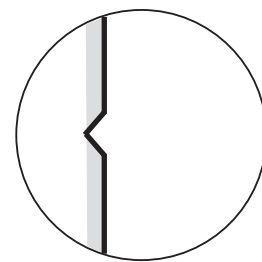

(3) Target pushed outward

1. Transmit on the shortest range, then adjust the gain and the A/C SEA.
2. Visibly select a target that creates a straight line (harbor wall, straight piers).
3. Open the [Installation] menu and select [Timing Adjust].
4. Press the **ENTER** key to show the timing adjustment window.
5. Press **▲** or **▼** to make straight the target selected at step 2, then press the **ENTER** key to finish.

1. INSTALLATION & WIRING

- **[MBS Adjustment]:** Suppress the main bang (black hole at center of screen), which appears at the display center on short ranges, as follows.
Note: Before doing this procedure, adjust the STC moderately.
 1. Set the radar to transmit mode.
 2. Open the [Installation] menu and select [MBS Adjustment].
 3. Press the **ENTER** key to show the MBS adjustment window.
 4. Press **▲** or **▼** on the cursorpad so that the main bang is reduced.
 5. Press the **ENTER** key to finish.
- **[Magnetron Readjust]:** Readjust the output power after magnetron replacement as follows:
Note 1: Before doing this procedure, transmit the radar more than 10 minutes on a long range and check that [Sector Blanks] are both set to [Off].
Note 2: This menu is not available when DRS4DL+, DRS4D X-Class and DRS2D/4D/6A/12A/25A-NXT.
 1. Transmit on the maximum range.
 2. Open the [Installation] menu and select [Magnetron Readjust], then press the **ENTER** key.
 3. Press **▲** on the cursorpad to select [Yes], then press the **ENTER** key.
The tuning adjustment begins automatically, and the message "Magnetron Readjusting" appears during tuning adjustment. After the tuning adjustment is completed, the timing and video are adjusted in that order, showing appropriate status messages. After all adjustments are completed, the window disappears. If the result for any item is not best for your conditions, manually adjust the item according to the procedure in this section.
- **[Total On Time]:** You can set the total on time as shown below.
Note: This item is intended for the serviceman; do not change the setting.
 1. Open the [Installation] menu and select [Total On Time].
 2. Press the **ENTER** key.
 3. Press **▲** or **▼** on the cursorpad to set value. The range is 000000.0H to 999999.9 H.
 4. Press the **ENTER** key to finish.
- **[Total TX Time]:** You can set the total TX time as shown below.
Note: Send an operator fitness sentence to devices on the same network when something is done at with FR-10/12.
 1. Open the [Installation] menu and select [Total TX Time].
 2. Press the **ENTER** key.
 3. Press **▲** or **▼** on the cursorpad to set value. The range is 000000.0H to 999999.9 H.
 4. Press the **ENTER** key to finish.
- **[Alert Out Type]:** Select the method of alert output.
 - [External Buzzer]: An external buzzer sounds in conjunction with the alert status.
 - [AlarmOut]: The contact signal output is switched in conjunction with the alert status.

- [Operator Fitness]: Outputs user operation status as a contact signal, for operator fitness equipment.
Note: To prevent erroneous recognition due to vibration, etc., the contact signal is not output when the cursor is moved by the USB mouse or trackball. Click left or right or operate the panel keys on the main unit.
- [Input Datum]: Select the geodetic data to use for positioning data input from external equipment ([WGS84] or [Tokyo]). The default setting is [WGS84].
- [Geodetic Datum]: Select the datum to use for the display of positioning data.
Note: AIS target data uses the WGS84 datum regardless of the setting selected here.
- [Memory Reset]: The memory reset feature restores all settings to default. This also affects antennas connected via LAN and FR-12 units with RP (chart) functionality connected via serial.
 1. Open the [Installation] menu and select [Memory Clear].
 2. Press the **ENTER** key.
 3. Press **▲** or **▼** on the cursorpad to select [Yes], then press the **ENTER** key.
 4. Press the **ENTER** key to finish. The system reboots and default settings are restored.

1.4.3 How to set up main/sub radar displays

Set [Main/Sub Radar] to [Sub 1/2] in [System Installation] to operate as a sub display and the menu and screen display will change accordingly. To display radar images on the second display, the main display must be transmitting.

Note 1: Make sure that [Sub 1] and [Sub 2] do not overlap in the same system.

Note 2: The [Main/Sub Radar] setting cannot be changed during transmission.

Screen display

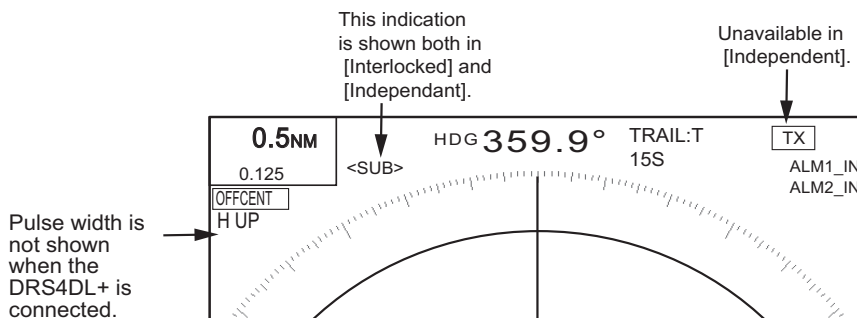

Set up main/sub radar display

Up to three display units can be connected to one radar sensor. One of the display units is configured as the main display (for rigging and transmitting/preparing the radar sensor) and the rest are configured as sub display units. Up to two radar sensors can be configured in a network. The maximum number of display units in a network is six.

1. INSTALLATION & WIRING

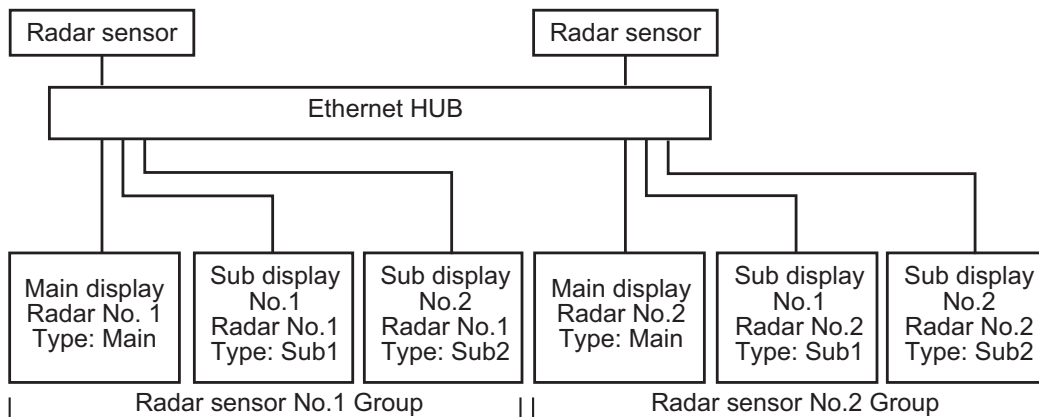

Max configuration of radar sensor and display

Note 1: When setting the radar number of the main display, set the antenna unit on the network to the same number. Before setting, make sure that only one display unit and one antenna unit is connected.

Note 2: The sub display must be configured independently before connecting to the network.

Note 3: If there is only one antenna unit, changing the radar number is not required. Set up the main and sub display only.

1. Open the [Installation] menu and select [Main/Sub Radar].
2. Select [Radar No.], then press the **ENTER** key. A drop-down selection menu appears.

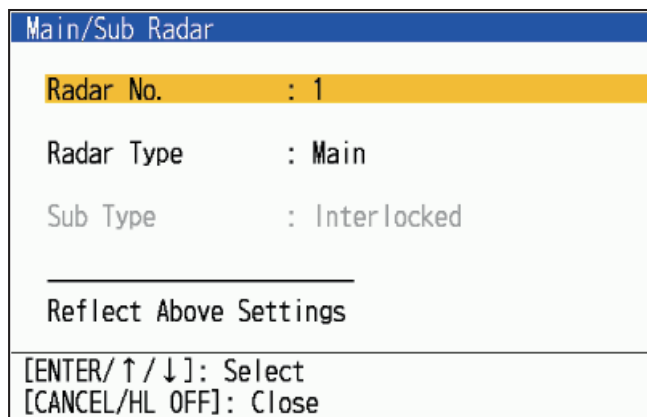

3. Press **▲** or **▼** on the cursorpad to select [1] or [2], then press the **ENTER** key. When the DRS4DL+ is connected, available radar number is [1] only.
4. Select [Radar Type], then press the **ENTER** key. A drop-down selection menu appears.
5. Select the type you want to assign, then press the **ENTER** key. A screen to confirm appears.
6. Select [Yes] to apply the settings.
7. Select [Sub Type], then press the **ENTER** key.
8. Select the desired type, then press the **ENTER** key.
9. Press the **MENU** key to finish.
10. Select [Reflect Above Settings], then press the **ENTER** key. A confirmation message appears.

11. Select [Yes] to apply the settings and reboot the system.
Select [No] to go back to the menu and cancel changes/make further changes.

Operation restrictions of the sub display

The radar function related to the antenna unit can be controlled independently by the main display and the sub display. Refer to the table shown below to find the availability of radar functions on sub display units.

- **[Independent]:** Settings changed on this unit are only applied to this unit. This setting also activates the dual-range mode on antenna units all compatible antenna units (excluding DRS4DL+. For DRS4DL+, type is automatically set to [Interlocked] and cannot be changed).
- **[Interlocked]:** Settings changed on the main display are reflected to this display unit.
Radar functions are controlled independently, interlocked or commonly depending on selection as Master or Slave (see the table below).

Radar Functions	Sub display setting [Interlocked]	Sub display setting [Independent]
[Brill/Color], [Display], [Cursor], [Marker], EBL, VRM TT, AIS, Watchman, Chart, Echo Stretch, Echo Average, [Low Level Echo], [Trails], [Target Alarm]	The desired value can be set.	
Range, Sensitivity, Sea clutter*, Rain/Snow clutter/Int Rejector, Target Analyzer™*, Rez Boost™, TT acquire*, [AC/Auto], [Display-Dynamic], [Display -Curve]	Interlock with main display unit.	Independent from the main display unit.
Watchman, Pulse Width, [Tuning/Channel]		Unavailable
[Scan Timing], [Heading Alignment], [MBS Adjust], [STC Range], [Near STC Level], A/C Auto Adjust Range, [Heading Alignment], Near STC Level, A/C Auto Adjust	Unavailable	

*: When using the NXT series radar in the [Independent] mode, interference suppression, Target Analyzer mode and all display units are interlocked.

1.4.4 How to set up the File menu

When a USB memory is connected, you can write/read/delete the setting data and installation data. You can also write/overwrite log data.

1. Insert a USB memory into the slot.
2. Press the **MENU** key to open the menu.

1. INSTALLATION & WIRING

3. Open the [File] menu and press the ENTER key.

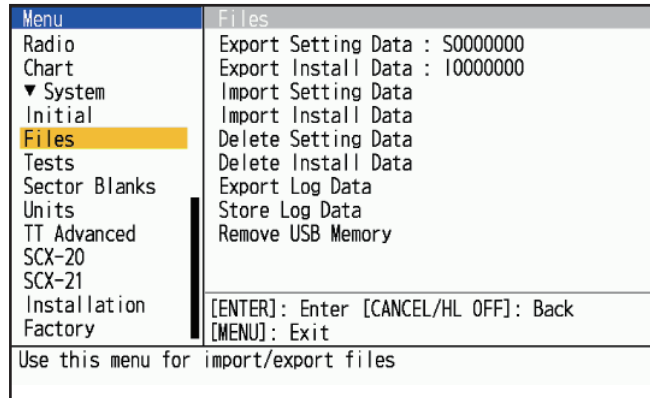

4. Press ▲ or ▼ on the cursorpad to select the menu referring to below table, then press the ENTER key.

Menu	Description
Export Setting Data	Exports setting data (upper than [Tests]) to USB memory. Cannot set same file name.
Export Installation Data	Exports installation data (lower than [Tests]) to USB memory. Cannot set same file name.
Import Setting Data	Imports setting data (upper than [Tests]) from USB memory. Popup window to select file name will appear.
Import Installation Data	Imports installation data (lower than [Tests]) from USB memory. Popup window to select file name will appear.
Delete Setting Data	Deletes setting data (upper than [Tests]) from USB memory.
Delete Installation Data	Deletes installation data (lower than [Tests]) from USB memory.
Export Log Data	Log data stored in the save area of internal memory is exported to USB memory. Popup window for confirmation appears.
Store Log Data	Log data is stored in the save area of internal memory. To confirm overwriting the existing data appears.
Remove USB Memory	Prepares to remove attached USB memory from the FR-10/12 safely. Popup window will appear.

5. Press ▲ or ▼ on the cursorpad to select [Yes], then press the ENTER key.
6. Press ▲ or ▼ on the cursorpad to select [Remove USB Memory], then press the ENTER key.
 Check the message and remove the USB flash memory.
Note: Failure to follow the steps to remove the USB memory may damage the data in the USB memory.
7. Press the CANCEL/HL OFF key to close the window.

1.4.5 How to change units of measurement

You can change the units of measurement for range and speed with the following procedure.

Menu	Units
Radio	Range Unit : NM
Chart	Ship Speed Unit : kn
▼ System	
Initial	
Files	
Tests	
Sector Blanks	
Units	
TT Advanced	
SCX-20	
SCX-21	
Installation	[ENTER]: Enter [CANCEL/HL OFF]: Back
Factory	[MENU]: Exit
Set up units of measurement	

1. Open the [Units] menu.
2. Set the range and speed units as desired.

Menu item	Available options
[Range Unit]	NM, km, SM
[Ship Speed Unit]	kn, km/h, mph

3. Close the menu.

1.4.6 Advanced TT settings

The [TT Advanced] menu contains settings for the TT feature. This menu is protected and adjustments/changes should only be made by a qualified FURUNO technician.

1.4.7 SCX-20 settings

The items described in this section assume that your FR-10/12 is connected with an SCX-20 on the same NMEA2000 network. If a SCX-20 is not connected, the menu items cannot be changed. For detailed instructions on these settings, see the operator's manual for the SCX-20.

- **[SBAS Mode]**: Set to [On] to use the SCX-20 for SBAS (Satellite Based Augmentation System). Set to [Off] to ignore SBAS on SCX-20.
- **[Offset Heading]**: Apply an offset to the heading data sends from the SCX-20.
- **[Offset Pitch]**: Apply an offset to the pitch data sends from the SCX-20.
- **[Offset Roll]**: Apply an offset to the roll data sends from the SCX-20.
- **[Smoothing SOG/COG]**: Sets the time for smoothing (averaging) ground speed data.
- **[Smoothing ROT]**: Apply time-based "buffer" to ROT data received from the SCX-20.
- **[PGN Settings]**: View and adjust the baudrate for the PGN output from the SCX-20.
- **[Factory Reset]**: Restore the SCX-20 to factory default settings.

1.4.8 SCX-21 settings

The items described in this section assume that your FR-10/12 is connected with a SCX-21. If a SCX-21 is not connected, the menu items cannot be changed. For detailed instructions on these settings, see the operator's manual for the SCX-21.

Note: Connect to NMEA0183 port 1 when initializing the SCX-21.

- **[Datum]:** Select the datum to use for SCX-21 positioning. The default setting is [WGS84]. To manually select a datum other than [WGS84] or [WGS72], select [Other].
- **[Datum Number]:** Set the datum for the SCX-21 to use for positioning. This menu item is only available when [Datum] is set to [Other].
- **[SBAS Mode]:** Set to [On] to use the SCX-21 for SBAS (Satellite Based Augmentation System). Set to [Off] to ignore SCX-21's SBAS.
- **[Offset HDG]:** Apply an offset to the heading data sends from the SCX-21.
- **[Offset Pitch]:** Apply an offset to the pitch data sends from the SCX-21.
- **[Offset Roll]:** Apply an offset to the roll data sends from the SCX-21.
- **[Smoothing SOG/COG]:** Apply time-based "buffer" to SOG/COG data received from the SCX-21.
- **[Smoothing ROT]:** Apply time-based "buffer" to ROT data received from the SCX-21.
- **[Port1 Setting]:** Set the load rate and baudrate for output sentences from the SCX-21's Port1.
- **[Port2 Setting]:** Set the load rate and baudrate for output sentences from the SCX-21's Port2.
- **[Port3 Setting]:** Set the load rate and baudrate for output sentences from the SCX-21's Port3.
- **[Factory Reset]:** Restore the SCX-21 to factory default settings.

2. OPERATION

2.1 Display Unit Controls

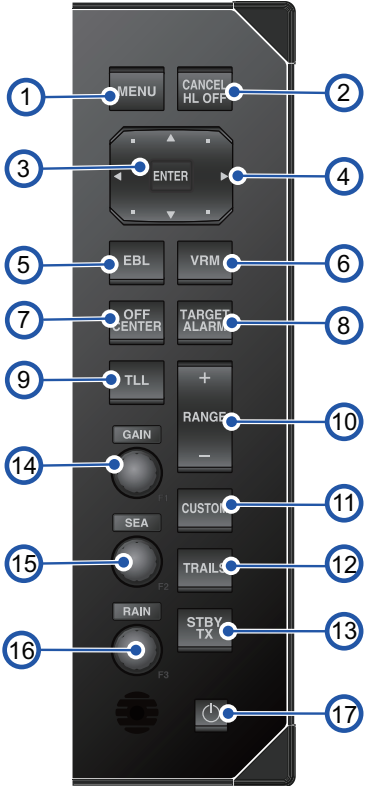
	Description
	1: MENU key. Press to open/close the menu.
	2: CANCEL/HL OFF key. During normal operation (press and hold): Hides the heading line.
	3: ENTER key. During normal operation (short press): Removes cursor selected marks/TT targets or sleep AIS targets. During menu operation: Go up one layer in the menu or cancel the current selection.
	4: CURSOR pad. During normal operation: Moves the cursor on the radar screen. During menu operation: Selects menu items or menu options.
	5: EBL key. Measure the bearing to a target.
	6: VRM key. Measure the range to a target.
	7: OFF CENTER key. Toggles the off-center setting between [Off] and [Manual]/[Custom].
	8: TARGET ALARM key. With no alarm areas set: Creates a start point for an alarm area. With alarm areas set: Toggles selection of the alarm areas.
	9: TLL key. With TLL output enabled: Outputs the cursor location (coordinates) to a chart plotter, etc. which is connected to the same network. Both HDG and Ship's position are required. With Fixed Marks mode active: Shows the fixed marks.
	10: RANGE keys. Adjusts the range.
	11: CUSTOM key. Recalls and applies custom presets.
	12: TRAILS key. Short press: Toggles the trail time settings. Press and hold: Erases the trail.
	13: STBY/TX key. Toggles the radar between standby and transmit modes.
	14: A/C SEA knob. Turn to adjust the [MANUAL SEA] setting. Press to activate the function for the F2 key.
	15: GAIN knob. Turn to adjust the gain. Press to activate the function for the F1 key.
	16: A/C RAIN knob. Turn to adjust the [MANUAL RAIN] setting. Press to activate the function for the F3 key.
	17: POWER/BRILL key. Short press: Shows the brilliance/contrast settings. Press and hold: Turns the power on/off.

2.2 How to Turn the Radar On/Off

Press the (\odot /BRILL) key to turn on the display unit. To turn off the display unit, press and hold down the key until the screen turns off (approx. 3 seconds). After turning on the power of the antenna sensor, "No Radar" is shown on the display unit until the communication with the display unit is established.

When you turn on the antenna unit, the initializing screen is shown, the preparation screen will appear after about 5 seconds, and the time to warm the magnetron will start counting on the screen. Its time is 90 seconds.

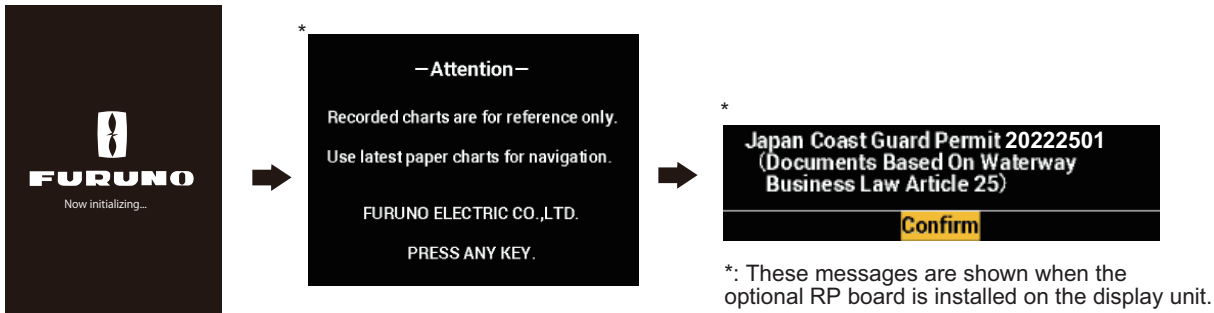

Note 1: When the DRS2D/4D/6A/12A/25A-NXT is connected, transmission can start soon after showing the initializing screen.

Note 2: When you turn off the power during the transmission, the antenna unit switches to STBY mode for safety. It is advised to turn off the antenna unit from the switchboard as soon as possible.

2.3 TX/Standby

After the magnetron has warmed (the time to warm the magnetron is not required on the NXT series radar), the indication [STBY] appears at the screen center. The radar is now ready to transmit radar pulses.

To switch between TX and standby, push the **STBY/TX** key.

The antenna rotates in transmit and is stopped in standby.

Note: The display unit supplies "standby power" to the antenna unit when the display unit is turned off. If use of the radar is not required for an extended period, shut off the radar at the breaker.

2.4 Display Indications

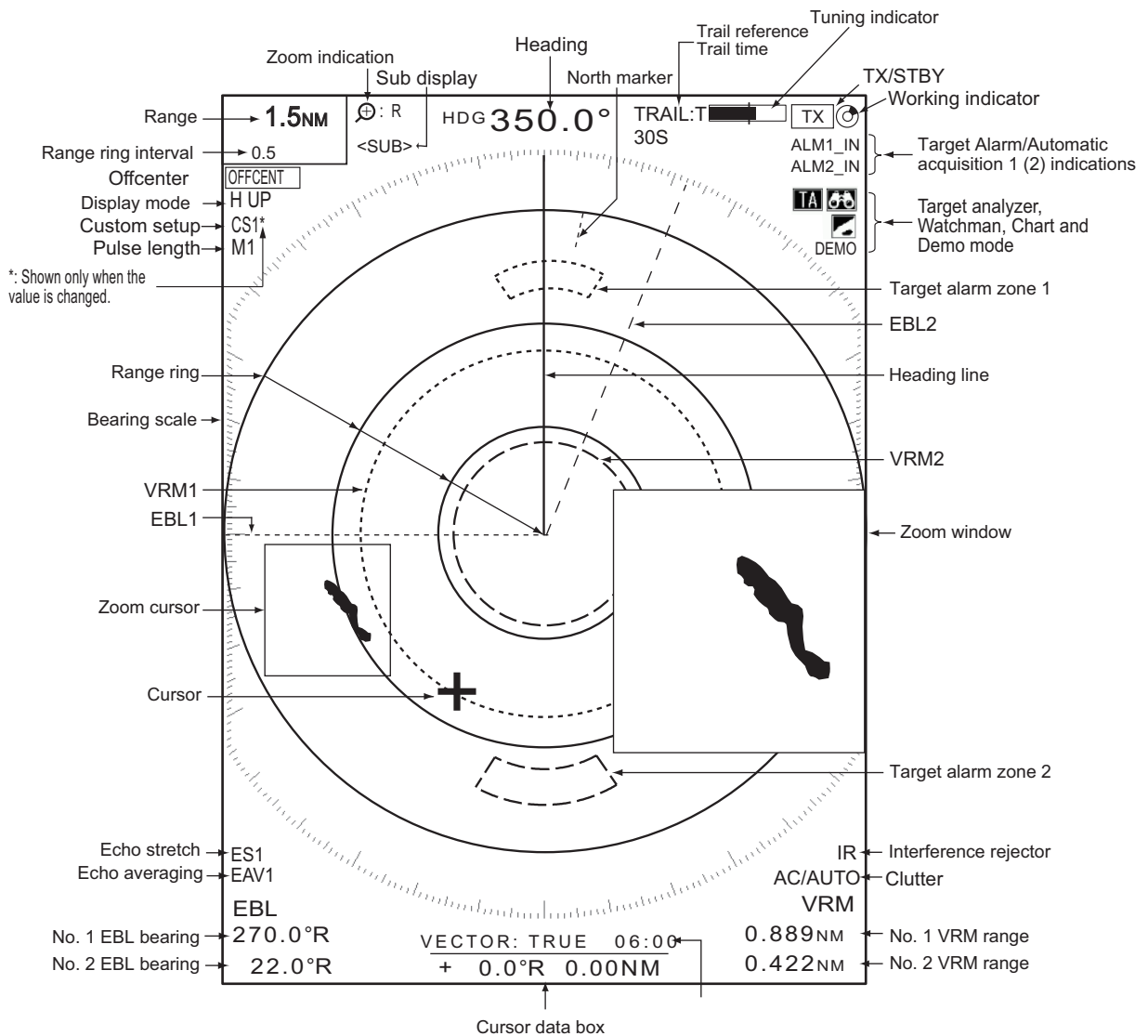

NAV data box

Various navigation data can be shown below the Vector time/Cursor data box. Use the DATA BOX knob to select a data display. The example below shows nav data (NAV position on DATA BOX knob).

34°56.123' N 135°34.567' E OS SPD 12.3KN	+ 34°56.123' N 135°34.567' E CURS TTG 00:00	BRG 14.8° RNG 0.876NM WPT TTG 00:00
--	---	---

2.5 How to Adjust Display Brilliance, Panel Dimmer

You can adjust the display screen brightness (brilliance) and keypad brightness (panel dimmer) as follows:

1. Press the (ϕ /BRILL) key to show the [Brill/Panel] window.

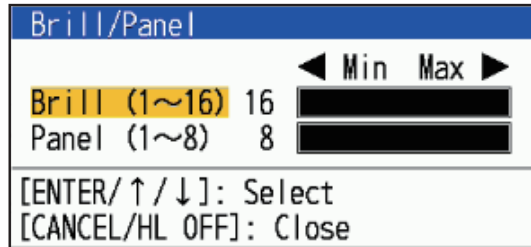

2. Use the cursorpad to select [Brill] or [Panel] as required.
3. Use the cursorpad to adjust.
For brilliance, you can also use the (ϕ /BRILL) key.
4. Press the CANCEL/HL OFF key to close the window.

2.6 Menu Description

This radar series has 16 menus and sub menus. Below is the basic procedure for menu operation.

1. Press the **MENU** key to open the menu.

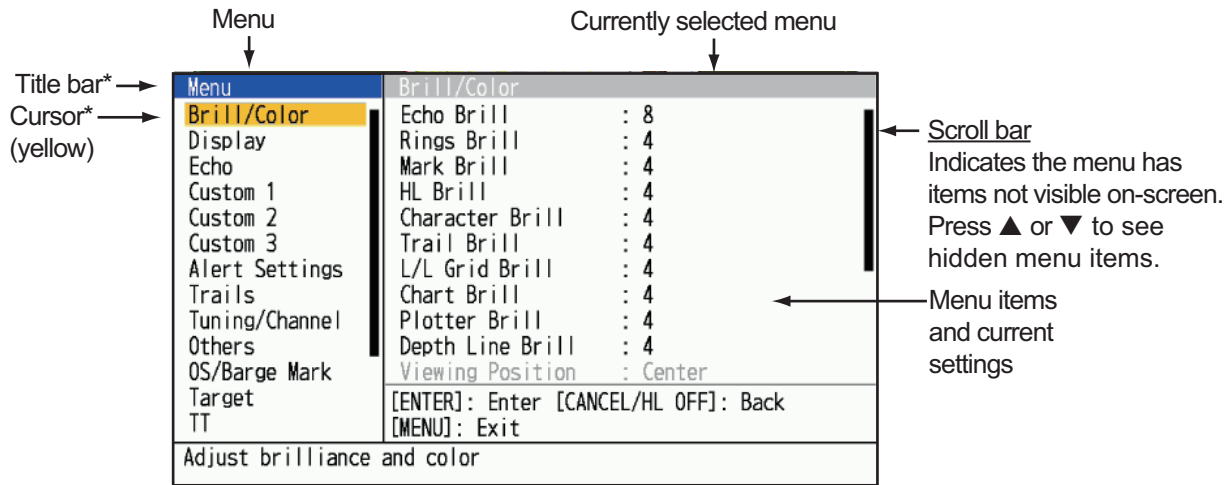

↑
Guidance message
Brief description for selected menu.

*: Title bar in currently controlled column is blue; cursor selection is yellow. Title bar of inactive column is gray.

2. Select a menu or a sub menu. The cursor (yellow) in the Menu column highlights the menu currently selected. The menu items in the right window change according to the menu selected.

Menu description

- [Brill/Color]: Adjust the brilliance and color.
- [Display]: Set up the display-related features.
- [Echo]: Adjust the echo features.
- [Custom 1/2/3]: Customize user settings.
- [Alert Settings]: Set up alerts.

[**Trails**]: Process trails of the radar targets.

[**Tuning/Channel**]: Adjust the radar tuning (magnetron radars), change the channel (solid-state radars).

[**Others**]: Set up other items.

- [**PI LINES**]: Set up the number of PI lines.

- [**PI Line Mode**]: Set up the mode of PI lines.

- [**Cursor Type**]: Set up the cursor type.

[**OS/Barge Mark**]: Set up the own ship mark and barge mark.

[**Target**]: Set up the targets configuration (for TT/AIS).

[**TT Advanced**]: Set up the TT (Target Tracking).

[**AIS**]: Set up the AIS.

[**Radio**]: Set up the other ships indication (see chapter 6).

[**Chart**]: Set up the chart (available only for FR-10 with RP board installed, see chapter 7).

[**System**]:

- [**Initial**]: Initial settings.

- [**Files**]: Set up the setting files.

- [**Tests**]: System diagnostic and LCD test.

- [**Sector Blanks**]: Prevent the transmission in a certain area.

- [**Units**]: Set up units of measurement.

- [**TT**]: Set up TT system. For the installer. Do not change the settings.

- [**SCX-20**]: Set up the SCX-20.

- [**SCX-21**]: Set up the SCX-21.

- [**Installation**]: For installation.

- [**Factory**]: Select the display language; update software.

3. Press the **ENTER** key to switch the control to the menu items column. The cursor in the menu column now turns gray and the cursor in the menu items column is yellow.

To switch control from the menu items column to the menu column, use the **MENU** key. The color of the title bar of the active column is blue and the inactive column is gray.

4. Select a menu item, then press the **ENTER** key. A window with options for the related menu item appears.



[Display Color]
menu

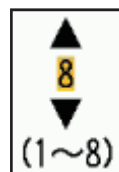

[Echo Brill]
menu

5. Press **▲** or **▼** on the cursorpad to select an option or set a numeric value.
6. Press the **ENTER** key to save your selection. To close the window without saving, press the **MENU** key.
7. Press the **MENU** key to close the menu.

2.7 Display Modes

This radar has the display modes shown below. All modes except head up and stern up require a heading signal. The true motion mode additionally requires position data.

Relative Motion (RM) displays

- [Head Up] ([H UP]): Heading is at the top of the screen. The picture is redrawn in realtime. The bearing scale fixes in true view.
- [Course Up] ([C UP]): The heading line positions to the course bearing at the moment the course up mode is selected. The bearing scale rotates accordingly.
- [North Up] ([N UP]): North is the reference direction; the bearing scale is fixed.
- [Stern Up] ([S UP]): Ship's stern is at the top of the screen.

True Motion (TM) displays

- [True Motion] ([TM]): Land objects and sea are stationary. Only the ship moves on the screen.

2.7.1 How to select the display mode

1. Press the **MENU** key to open the menu.
2. Select [Display], then press the **ENTER** key.

Menu	Display
Brill/Color	Display Mode : Head Up
Display	Zoom : Off
Echo	Zoom Reference : Relative
Custom 1	Off-center Mode : Custom
Custom 2	Save Off-center
Custom 3	Echo Area : Oval
Alert Settings	Text Display
Trails	Data Box : Off
Tuning/Channel	Gain/Sea/Rain Bar
Others	
OS/Barge Mark	
Target	[ENTER]: Enter [CANCEL/HL OFF]: Back
TT	[MENU]: Exit
Select an orientation mode	

3. Select [Display Mode], then press the **ENTER** key.

Head Up
Course Up
North Up
True Motion
Stern Up

4. Select a display mode, then press the **ENTER** key.
5. Press the **MENU** key to close the menu.

Note 1: The display mode is automatically switched to head up if the heading signal is lost.

Note 2: All modes except head up and stern up require a heading signal in AD-10 format or NMEA format. If the heading signal is lost, the mode is changed to head up and the north mark disappears. The display for heading becomes *****.*** and the alarm sounds. The message "GYRO" (AD-10 format data) or "NMEA_HDG" (NMEA format data) appears in the alarm message display. To stop the audio alarm, press any key.

When the heading signal is returned, check the heading. The numeric value is displayed at the heading indication when the heading signal is returned.

2.7.2 Description of display modes

Head up mode

A display without azimuth stabilization in which the line that connects the center with the top of the display indicates your heading. Targets are shown at their measured distances and their directions relative to your heading. The short dotted line on the bearing scale is the north mark. The echoes move in real time depending on the change of the heading of your ship.

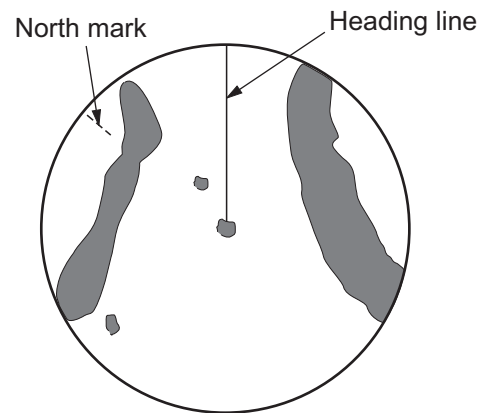

Course up mode

The radar picture is stabilized and displayed with the currently selected course at the top of the screen. When you change the heading, the heading line moves with the course selected. If you select a new course, select the course up mode again to display the new course at the top of the display.

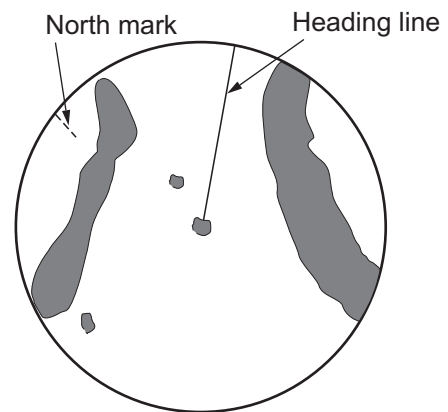

Targets are shown at their measured distances and their directions relative to the set course, which is at the 0-degree position.

The heading line moves according to the yawing and any course change.

North up mode

Targets are shown at their measured distances and their true (compass) directions from your ship. North is at the top of the screen. The heading line changes its direction according to your heading.

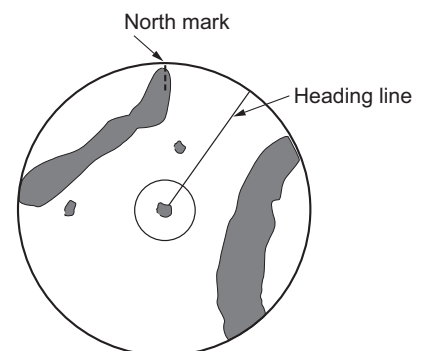

Stern up mode

The Stern up mode rotates the Head up mode picture, relative and true bearings and display graphics 180°. This mode is useful on dual-radar tugboats when backing up; one radar shows Head up and another shows Stern up. To enable the Stern up mode, turn on [Stern up] on the [OPERATION] menu.

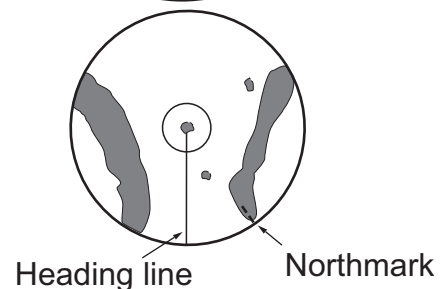

2. OPERATION

True motion mode

Your ship and other objects in motion move with their true courses and speed. All fixed targets, like landmasses, appear as fixed echoes in ground stabilized TM.

When your ship reaches a point that is 50% of the radius of the display, the position is reset. The ship appears at 75% radius opposite to the extension of the heading line on the display center. You can manually reset your ship symbol with the off-center feature.

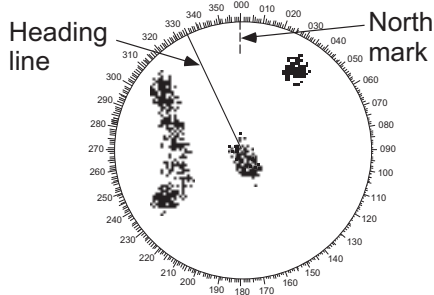
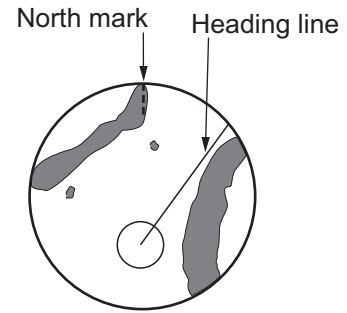

(a) True motion is selected

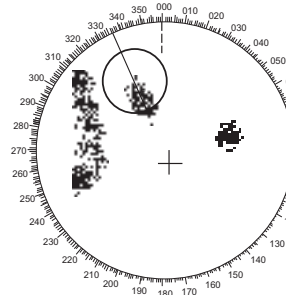

(b) Your ship has reached a point 50% of display radius

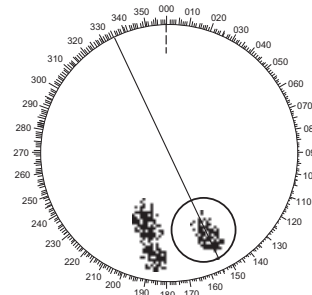

(c) Your ship is automatically reset to 75% of display radius

2.8 How to Temporarily Erase the Heading Line

The heading line is a line from your ship position to the outer edge of the radar display area, and indicates the heading of your ship in all display modes. The heading line appears at zero degrees on the bearing scale in head up mode. The heading line changes the orientation depending on the ship orientation in north up and true motion modes and when the course is changed in the course up mode.

In some cases, the heading line may hide a object. To erase the heading line to view an object hidden by the line, press the **CANCEL/HL OFF** key. The heading line, range rings, TT/AIS symbols, marks and chart overlay are temporarily erased. Release the key to show the line and rings again.

2.9 How to Select the Range Scale

The selected range scale, range ring interval and pulse length are shown at the top left corner on the screen. When an objective target comes closer, reduce the range scale so that the target appears in 50-90% of the display radius.

Press the **RANGE** button to select range. Press **[+]** to shrink the target, or **[-]** to enlarge the target.

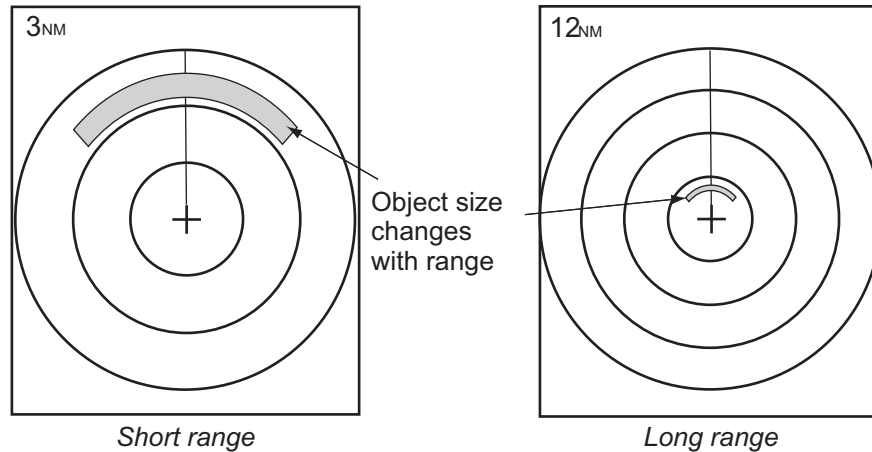

2.10 How to Adjust the Gain (sensitivity)

The gain control adjusts the sensitivity of the receiver for the best reception. The gain can be adjusted automatically or manually.

1. Press the **MENU** key to open the menu.
2. Press **▲** or **▼** to select [Echo].
3. Press **▲** or **▼** to select [Gain Mode] and press ENTER.



4. Press **▲** or **▼** to select [Auto] or [Manual] and press ENTER. The window for Gain/Sea/Rain indicator shown below appears. For [Auto], the window shown below appears. For [Manual] go to "Manual adjustment of gain" on the next page.

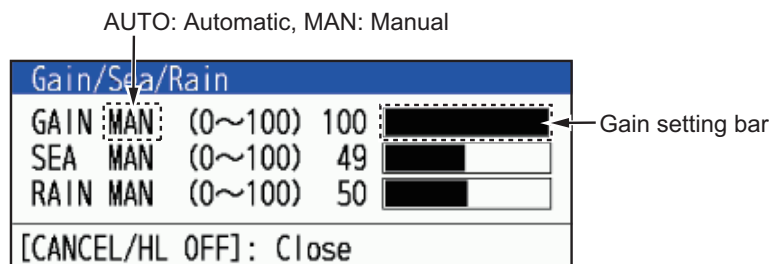

5. Press the **CANCEL/HL OFF** key to close the window.
6. Press the **MENU** key to close the menu.

Note: Rotate the GAIN knob while the [Gain Mode] is [Auto], The window shown below appears. Select [Yes] with the cursorpad and the Enter key to switch to the manual mode. Select [Yes] with the cursorpad and the Enter key to switch the

2. OPERATION

mode to [Manual]. Select [No] or press the **CANCEL/HL OFF** key, the screen will disappear with the mode [Auto].

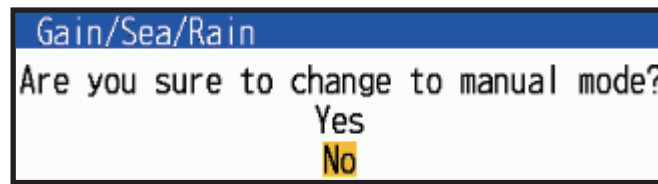

Manual adjustment of gain

1. Rotate the **GAIN** knob to adjust the gain so that weak noise appears on all of the screen. If the gain is too low, weak echoes are erased. If the gain is too high, the background noise hides weak targets.
2. Press the **CANCEL/HL OFF** key to close the window.

[Gais/Sea/Rain] window

The time to close the window for setting the above levels depends on the operation to open it.

Operations to open the window	Time to open the window
Select [Gain/Sea/Rain] bar on [Display].	10 sec
Rotate GAIN/SEA/RAIN knobs.	3 sec
Change settings of [Sea Mode], [Rain Mode] or [Gain] on [Echo].	

2.11 How to Reduce the Sea Clutter

The reflected echoes from the waves appear around your ship and have the name "sea clutter". The sea clutter extends according to the height of waves and antenna above the water. When the sea clutter hides the targets, use the sea clutter function to reduce the clutter, either manually or automatically.

How to select the sea clutter adjustment method

1. Press the **MENU** key to open the menu.
2. Press **▲** or **▼** to select [Echo].
3. Press **▲** or **▼** to select [Sea Mode] and press ENTER.
4. Press **▲** or **▼** to select [Auto] or [Manual] and press ENTER.
The window for Gain/Sea/Rain indicator shown below appears (see the figure on the step 4 of section 2.10). This window closes automatically when there is no menu operation for three seconds. [Auto] is for adjusting the sea clutter automatically. For [Manual] go to "Manual adjustment of rain clutter" below.
5. Press the **CANCEL/HL OFF** key to close the window.
If the sea clutter is strong while cruising along a coastline in the [Auto] mode, go to step 6. If not, go to step 9.
6. Press **▲** or **▼** to select [Auto Sea] and press ENTER.

7. Press ▲ or ▼ to select [Advanced], [Coastal] or [Channel] then press ENTER.

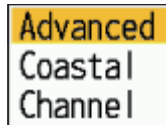

[Advanced]: Use this mode when sea surface reflections cannot be removed effectively in coastal areas.

[Coastal]: For general use. Distinguishes between sea surface reflections and land echoes and removes only sea surface reflections. The degree of removal of sea surface reflections is weaker than that of [Advanced].

[Channel]: Emphasizes land echoes where weak in coastal areas.

8. Press the **MENU** key to close the menu.

Note: Rotate the A/C SEA knob while the [Gain Mode] is [Auto], the window shown below appears. Select [Yes] with the cursorpad and the Enter key to switch the mode to [Manual]. Select [No] or press the **CANCEL/HL OFF** key, the screen will disappear with the mode [Auto].

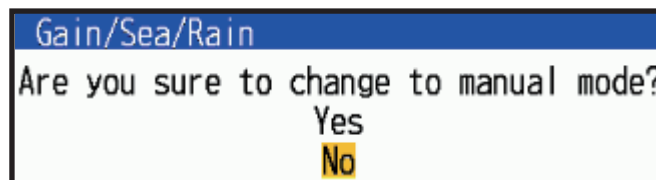

Manual adjustment of sea clutter

1. Rotate the **A/C SEA** knob to adjust the sea clutter.

Note: When the sea clutter is properly adjusted, the clutter is broken into small dots, and small targets become identified. If the setting is too low, targets are hidden in the clutter. If the setting is higher than necessary, both sea clutter and targets disappear from the display. Normally adjust the knob until the clutter has disappeared to leeward, but a small amount of the clutter is visible windward.

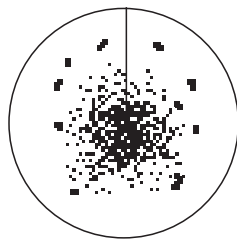

Sea clutter at screen center

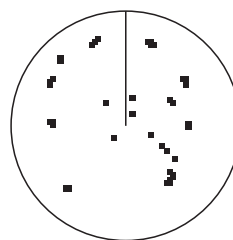

SEA control adjusted; sea clutter reduced

2. Press the **MENU** key to close the window.

2.12 How to Reduce the Rain Clutter

The reflections from the rain or snow appear on the screen. These reflections have the name "rain clutter". When the rain clutter is strong, targets in the rain clutter are hidden in the clutter. Reflections from the rain clutter are easily identified from true targets by their wool-like appearance.

The rain clutter function works like the sea clutter function, adjusting the receiver sensitivity, but in longer range. The higher the setting the more clutter is removed. The

2. OPERATION

rain control breaks the continuous display of rain or snow reflections into a random pattern. When the rain clutter hides the targets, adjust the rain clutter (automatic or manual) to reduce the clutter.

How to select the rain clutter adjustment method

1. Press the **MENU** key to open the menu.
2. Use ▲ or ▼ to select [Echo] and press **ENTER**.
3. Use ▲ or ▼ to select [Rain Mode] and press **ENTER**.
4. Use ▲ or ▼ to select [Auto] or [Manual] then press the ENTER key. The window for Gain/Sea/Rain indicator appears (see the figure on the step 4 of section 2.10). If you selected [Auto], go to step 5. For [Manual], go to "Manual adjustment of rain clutter" below.
5. Press the **CANCEL/HL OFF** key to close the window.
6. Use ▲ or ▼ to select [Auto Rain] and press **ENTER**.

Note: This item is not available with the DRS4DL+.

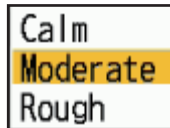

7. Use ▲ or ▼ to select [Calm], [Moderate] or [Rough] then press **ENTER**. The window for Gain/Sea/Rain indicator appears for confirmation (see the figure on the step 4 of section 2.10).

[Calm]: For light rain

[Moderate]: The system automatically determines and switches between a mode that suppresses unnecessary sea clutters and leaves strong echoes and a mode that makes it easier to see structures near land, such as piers and fish tanks based on echo conditions.

[Rough]: For heavy rain

8. Press the **CANCEL/HL OFF** key to close the window.
9. Press the **MENU** key to close the menu.

Note: When the DRS4DL+ and DRS-NXT series radar is connected, rotate the A/C RAIN knob while the [Gain Mode] is [Auto], below window is shown. Select [Yes] with the cursorpad and the Enter key to switch the mode to [Manual]. Select [No] or press the **CANCEL/HL OFF** key, the screen will disappear with the mode [Auto].

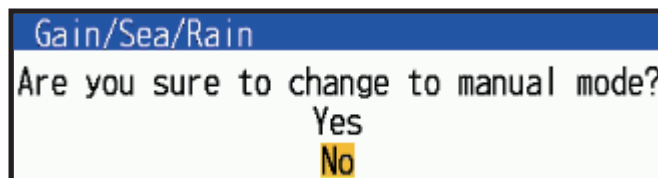

Manual adjustment of rain clutter

1. Rotate the **A/C RAIN** knob to adjust the rain clutter.
2. Press the **CANCEL/HL OFF** key to close the window.
3. Press the **MENU** key to close the menu

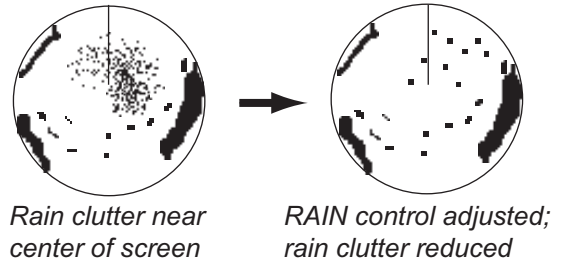

2.13 Automatic Adjustments of Sea and Rain Clutters

When you can not correctly reduce the sea clutter or rain clutter with the related control, turn on the automatic anti-clutter feature. When this feature is turned on, "A/C AUTO" appears at the lower-right corner.

Note: Not available with the DRS4DL+ and DRS-NXT series.

1. Press the **MENU** key to open the menu.
2. Use ▲ or ▼ to select [Echo] and press **ENTER**.
3. Use ▲ or ▼ to select [A/C Auto] and press **ENTER**.
4. Use ▲ or ▼ to select [Off] or [On] then press **ENTER**.
5. Press the **MENU** key to close the menu.

Caution on use

- Echoes that cover wide areas (like land and islands) can become smaller when the [A/C Auto] is used.
- When [A/C Auto] is active, the strength of a target in sea clutter or rain clutter can be lower than actual strength. In this case change to manual **A/C SEA** and manual **A/C RAIN** and adjust the picture.

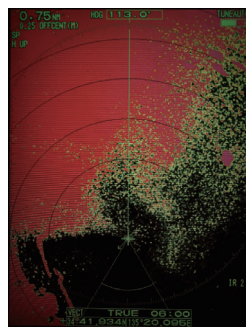

A/C Auto: Off

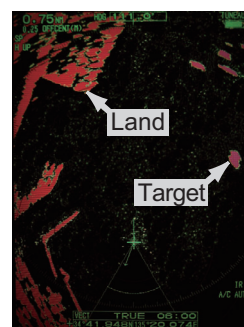

A/C Auto: On

2.14 Target Trails

The trails of the radar targets can be shown simulated in afterglow to check target movement. The target trails are selected for either relative or true. True motion trails require a heading signal and position data.

2.14.1 Trail time

1. Press the **MODE** key to open the [Mode] window.
2. Select [Trail Time], then press the **ENTER** key.

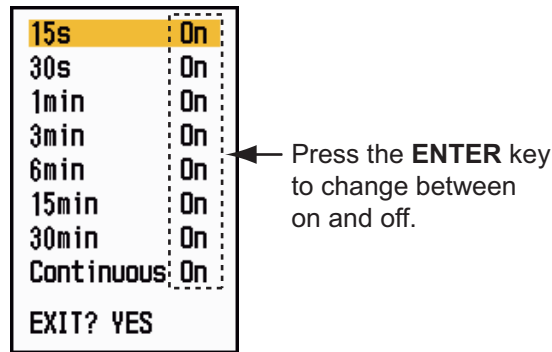

3. Select a time, then press the **ENTER** key.
 4. Press the **MENU/ESC** key to close the menu.
- The selected time appears at the top right corner.

2.14.2 How to activate/deactivate target trail

1. Press the **TRAILS** key to activate the target trail.
The selected trail mode and trail time appear at the top right corner. Depending on the trail time (see section 2.14.1), different trail times can be shown on the display with the **TRAILS** key.

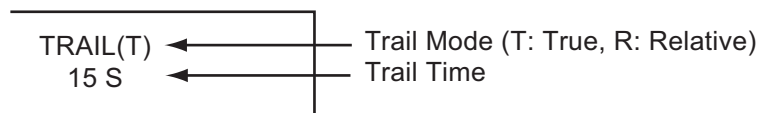

2. To change the trail time, press the **TRAILS** key several times until the desired time appears.

Note 1: Press and hold the **TRAILS** key until the buzzer sounds once to erase the track on the screen. You can also erase all tracks on the screen by selecting [Trail Erase] from the [Trails] menu.

Note 2: To deactivate the echo trail, press the **TRAILS** key several times until the trail time display on the upper right of the screen disappears.

2.14.3 Trail mode setting

You can display the echo trails in true or relative motion.

True mode

The true trails show true target movements according to their over-the-ground speeds and courses. The stationary targets do not show the trails. The true trails require a heading signal and position data.

Relative mode

The relative trails show other ships' movements relative to your ship. The stationary targets also show the trails.

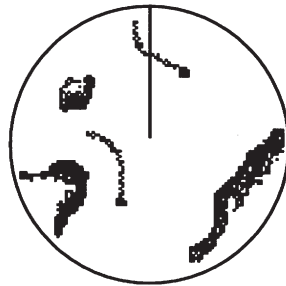

True target trails

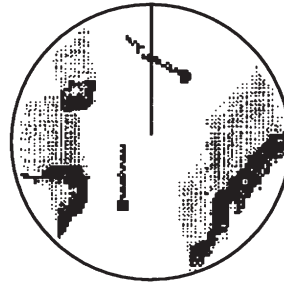

Relative target trails

To select the trail mode, do the following:

1. Press the **MENU/ESC** key to open the menu.
2. Select [Target Trails], then press the **ENTER** key.
3. Select [Mode], then press the **ENTER** key.
4. Select [Relative] or [True] then press the **ENTER** key.
5. Press the **MENU/ESC** key to close the menu.

Relative
True

2.14.4 Trail gradation

Trails can be shown in single or multiple gradation. Multiple gradation fades the gradation over time.

1. Press the **MENU** key to open the menu.
2. Select [Target Trails], then press the **ENTER** key.
3. Select [Gradation], then press the **ENTER** key.
4. Select [Single] or [Multi] then press the **ENTER** key.

Single
Multi

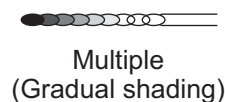
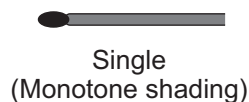

5. Press the **MENU** key to close the menu.

2.14.5 Trail color

You can select the color for trails as follows:

1. Press the **MENU** key to open the menu.
2. Select [Target Trails], then press the **ENTER** key.
3. Select [Color], then press the **ENTER** key.
4. Select a color, then press the **ENTER** key.
5. Press the **MENU** key to close the menu.

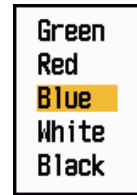

2.14.6 Trail level

You can select which target strength to display.

1. Press the **MENU/ESC** key to open the menu.
2. Select [Target Trails], then press the **ENTER** key.
3. Select [Level], then press the **ENTER** key.
4. Select [1], [2], [3] or [4] then press the **ENTER** key.
 - [1]: Display the trails for all targets (including weak targets).
 - [2]: Display the trails for slightly stronger than [1] targets.
 - [3]: Display the trails for slightly weaker than [4] targets.
 - [4]: Display the trails for only strong targets.
5. Press the **MENU/ESC** key to close the menu.

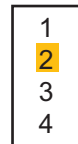

2.14.7 How to restart, stop the trails

When the range is changed while the trail feature is active, trails within the previous range scale can be stopped and restarted.

1. Press the **MENU** key to open the menu.
2. Select [Target Trails], then press the **ENTER** key.
3. Select [Restart], then press the **ENTER** key.
4. Select [Off] or [On] then press the **ENTER** key.
 - [Off]: When the range is changed, the trail is displayed according to the trail time set.
 - [On]: When the range is changed, the trail time is changed so that the apparent trail length is the same (The displayed trail time changes to yellow). The length of the trail can be changed by changing the trail time setting. When you change the trail length, reset the trail time according to the current range.

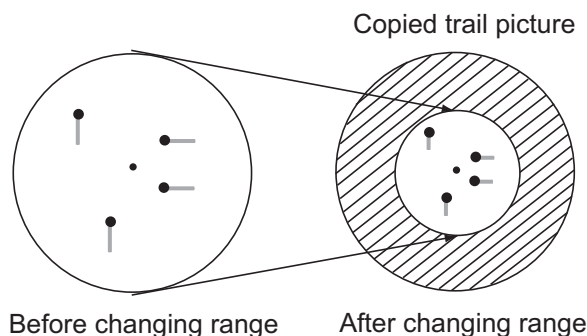

Note: If the newly selected range is less than or equal to 1/4 of the previous range, trails are erased. If the newly selected range is longer than the previous range, the previous trails are left to be displayed.

5. Press the **MENU** key to close the menu.

2.14.8 Own ship trail

You can show the trail of your ship as follows:

1. Press the **MENU/ESC** key to open the menu.
2. Select [Target Trails], then press the **ENTER** key.
3. Select [Own Ship], then press the **ENTER** key.
4. Select [Off], [1] or [2] then press the **ENTER** key.

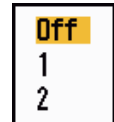

[Off]: Hide the trail of your ship.

[1]: Show the trail of your ship.

[2]: Show the trail of your ship, but hide the trail of sea clutter near your ship.

5. Press the **MENU/ESC** key to close the menu.

2.14.9 How to erase all trails

All trails can be erased by the methods shown below. A beep sounds upon completion of the erasure.

Erase all trails from the menu

1. Press the **MENU/ESC** key to open the menu.
2. Select [Trails], then press the **ENTER** key.
3. Select [Trail Erase], then press the **ENTER** key.
4. You are asked if you are sure to erase all trails. Press ▲ on the Cursorpad to select [Yes], then press the **ENTER** key.

Erase all trails with the MODE key

Press the **MODE** key to show the mode options. Select [Trail Erase], then press the **ENTER** key.

2.15 Cursor

The cursor functions to find the range and bearing to a target or the latitude and longitude position of a target. Use the cursorpad to position the cursor and read the cursor data. Cursor data appears at the bottom of the screen and by default shows the bearing to the cursor location, followed by the range to the cursor location.

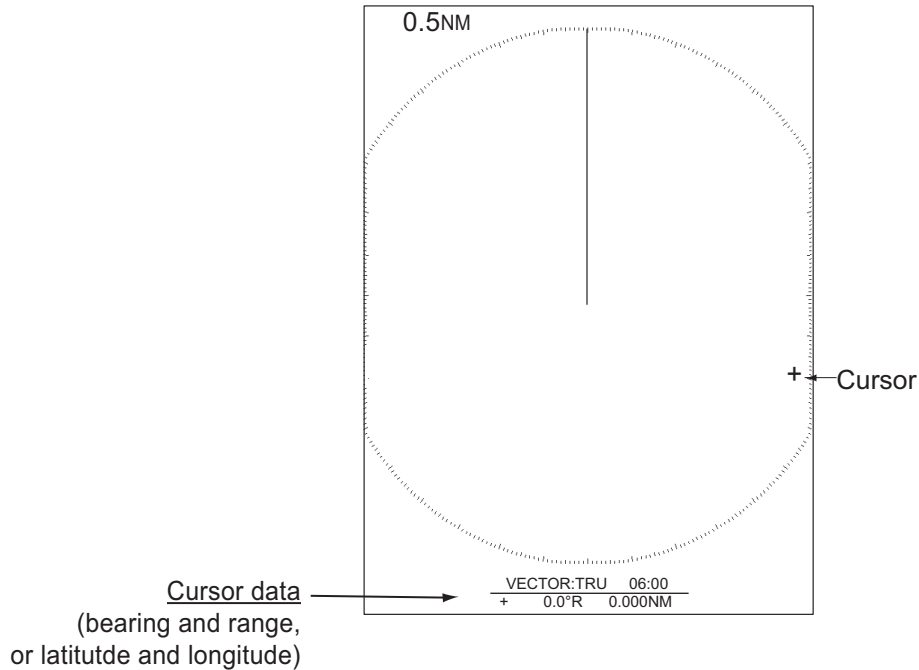

How to change the cursor data type

You can show the cursor data as range and bearing (from your ship to the cursor) or as latitude and longitude at the cursor location. Position and heading signal are required for either data type.

1. Press the **MENU** key to open the menu.
2. Press **▲** or **▼** to select [Others], then press the **ENTER** key.

Menu	Others
Brill/Color	F1 Setup : Gain Mode
Display	F2 Setup : Sea Mode
Echo	F3 Setup : Rain Mode
Custom 1	WPT Mark : Off
Custom 2	EBL Reference : Relative
Custom 3	VRM Unit : NM
Alert Settings	Cursor Data : Rng/Brg
Trails	TLL Mode : TLL Output
Tuning/Channel	PI Lines : Off
Others	PI Line Mode : Parallel
OS/Barge Mark	Cursor Type : 1
Target	[ENTER]: Enter [CANCEL/HL OFF]: Back
TT	[MENU]: Exit
Select the function assigned to [F1]	

3. Press **▲** or **▼** to select [Cursor Data], then press the **ENTER** key.

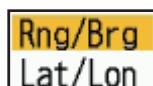

- Press ▲ or ▼ to select [RNG/BRG] or [LAT/LON] then press the **ENTER** key.
Note: When [Nav] or [All] is selected on [Data Box] menu, latitude and longitude of cursor is shown above data box. Therefore, the contents of data box is not changed when [Lat/Lon] is selected.
- Press the **MENU** key to close the menu.

Cursor type

Cursor type can be selected as follows:

- Press the **MENU** key to open the menu.
- Press ▲ or ▼ to select [Others], then press the **ENTER** key.

Menu	Others
Brill/Color	F1 Setup : Gain Mode
Display	F2 Setup : Sea Mode
Echo	F3 Setup : Rain Mode
Custom 1	WPT Mark : Off
Custom 2	EBL Reference : Relative
Custom 3	VRM Unit : NM
Alert Settings	Cursor Data : Rng/Brg
Trails	TLL Mode : TLL Output
Tuning/Channel	PI Lines : Off
Others	PI Line Mode : Parallel
OS/Barge Mark	Cursor Type : 1
Target	[ENTER]: Enter [CANCEL/HL OFF]: Back
TT	[MENU]: Exit
Select the function assigned to [F1]	

- Press ▲ or ▼ to select [Cursor Type], then press the **ENTER** key.
- Press ▲ or ▼ to select [1] to [4] then press the **ENTER** key.

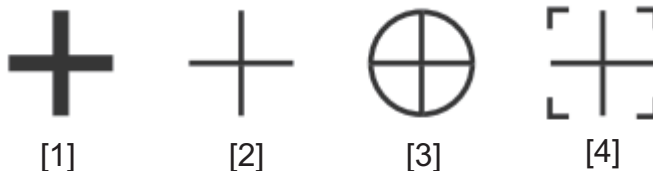

- Press the **MENU** key to close the menu.

2.16 How to Measure the Range to a Target

You can measure the range to a target in three methods. the fixed range rings, the cursor (if set to measure range and bearing), and the VRM (Variable Range Marker).

Use the fixed range rings to get a rough estimate of the range to a target. The fixed range rings are the concentric solid circles about your ship. The number of rings changes with the selected range scale. The interval of the range ring is displayed at the upper-left corner of the screen. Count the number of rings between the center of the display and the target. Check the range ring interval and measure the distance of the echo from the nearest ring.

2.16.1 How to adjust range ring brilliance

1. Press the **MENU** key to open the menu.
2. Press **▲** or **▼** to select [Brill/Color], then press the **ENTER** key.

Menu	Brill/Color
Brill/Color	Echo Brill : 8
Display	Rings Brill : 4
Echo	Mark Brill : 4
Custom 1	HL Brill : 4
Custom 2	Character Brill : 4
Custom 3	Trail Brill : 4
Alert Settings	L/L Grid Brill : 4
Trails	Chart Brill : 4
Tuning/Channel	Plotter Brill : 4
Others	Depth Line Brill : 4
OS/Barge Mark	Viewing Position : Center
Target	[ENTER]: Enter [CANCEL/HL OFF]: Back
TT	[MENU]: Exit
Adjust echo brilliance	

3. Press **▲** or **▼** to select [Rings Brill], then press the **ENTER** key.

Off
1
2
3
4

4. Press **▲** or **▼** to select an option, then press the **ENTER** key.
[4] is the brightest; [Off] turns off the range rings.
5. Press the **MENU** key to close the menu.

2.16.2 How to measure the range with a VRM

There are two VRMs, No. 1 and No. 2. The VRMs are dashed rings so that you can identify the rings from the fixed range rings. You can identify VRM 1 from VRM 2 by different lengths of dashes. The dashes of the No. 1 VRM are shorter than those of the No. 2 VRM.

1. Press the **VRM** key to select [VRM 1] or [VRM 2] as required. The corresponding VRM indication appears at the bottom right corner, inside a rectangle.
2. Use the cursorpad to align the VRM with the inner edge of the target. Read the distance at the lower-right corner of the screen. The size of the VRM ring changes in proportion to the selected range scale.
3. To anchor the VRM, press the **ENTER** key. To reactivate the VRM, press the **VRM** key again.
Note: To cancel the VRM, press the **CANCEL/HL OFF** key.
4. To erase a VRM, press the **VRM** key to select the VRM to erase. Press the **CANCEL/HL OFF** key to erase the VRM and its indication.

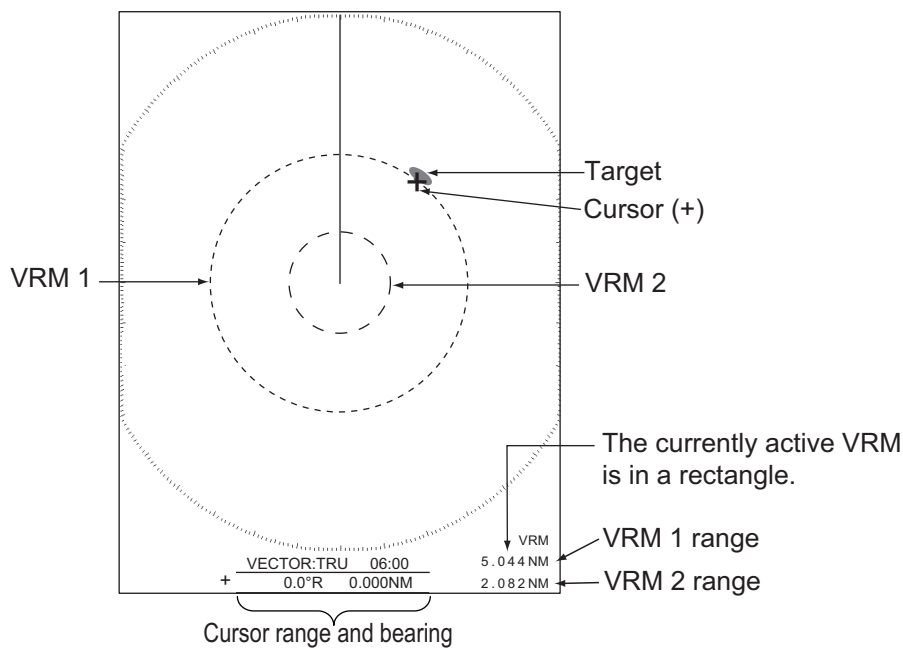

2.16.3 How to select VRM unit

You can select the unit of measurement used by the VRM. The selections are nautical miles (NM), kilometers (KM), statute miles (SM) or kiloyard (KYD). The cursor range unit is also changed when the VRM unit is changed.

1. Press the **MENU** key to open the menu.
2. Press **▲** or **▼** to select [Others], then press the **ENTER** key.
3. Press **▲** or **▼** to select [VRM Unit], then press the **ENTER** key.

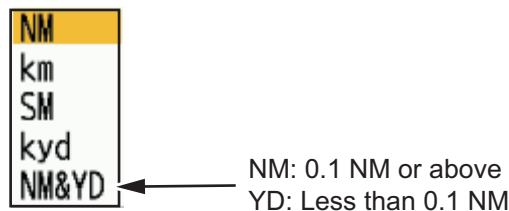

4. Select the unit, then press the **ENTER** key.
5. Press the **MENU** key to close the menu.

2.17 How to Measure the Bearing to a Target

Use the Electronic Bearing Line (EBL) to take a bearing of a target. There are two EBLs, No. 1 and No. 2. Each EBL is a straight dashed line from the center of the screen to the edge. The dashes of the No. 1 EBL are shorter than those of the No. 2 EBL.

2.17.1 How to measure the bearing with an EBL

1. Press the **EBL** key to select [EBL 1] or [EBL 2] as required.
The EBL indication appears at the bottom left corner with light blue. the ithe

2. OPERATION

2. Use the cursorpad to place the EBL through the center of the target. Read the distance at the bottom left corner of the screen. The cursor on the EBL provides an estimate of the range to a target.
3. To anchor the EBL, press the **ENTER** key. To reactivate the EBL, press the **EBL** key again.
Note: To cancel the EBL, press the **CANCEL/HL OFF** key.
4. To erase a EBL, press the **EBL** key to select the EBL to erase. Press the **CANCEL/HL OFF** key to erase the EBL and its indication.

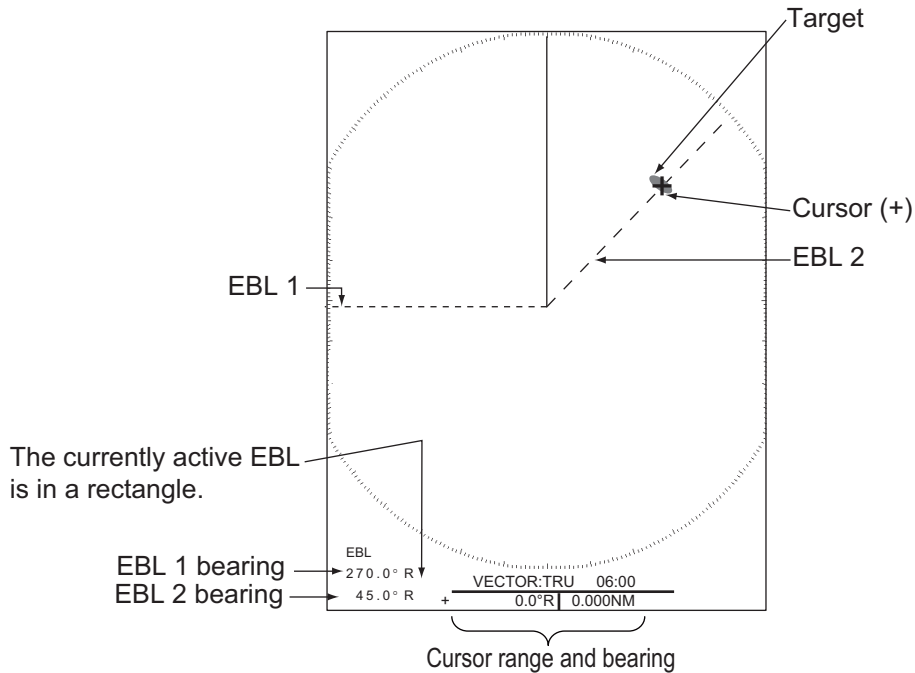

2.17.2 EBL reference

"R" (relative) follows the EBL indication if the bearing is relative to the heading of your ship. "T" (true) follows the EBL indication if the bearing is in reference to the north. You can select relative or true in the head up mode. The bearing indication is true in all other modes. True bearing requires a heading sensor.

1. Press the **MENU** key to open the menu.
2. Press **▲** or **▼** to select [Others], then press the **ENTER** key.
3. Press **▲** or **▼** to select [EBL Reference], then press the **ENTER** key.

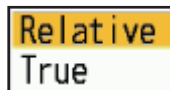

4. Press **▲** or **▼** to select [Relative] or [True] then press the **ENTER** key.
5. Press the **MENU** key to close the menu.

2.18 How to Measure the Range and Bearing Between Two Targets

You can move the origin of the EBL to measure the range and bearing between two targets.

1. Press the **EBL** key to select [EBL 1].
2. Use the cursorpad to put the cursor on the center of the target A, then press the **ENTER** key.
3. Press the **EBL** key again. The origin of the EBL moves to the cursor position.
4. Use the cursorpad to put the cursor on the center of the target B, then press the **ENTER** key.
5. Press the **VRM** key to select [VRM 1].
6. Use the cursorpad to set the VRM on the inner edge of the target B.
7. Read the bearing and range indications at the bottom of the screen.

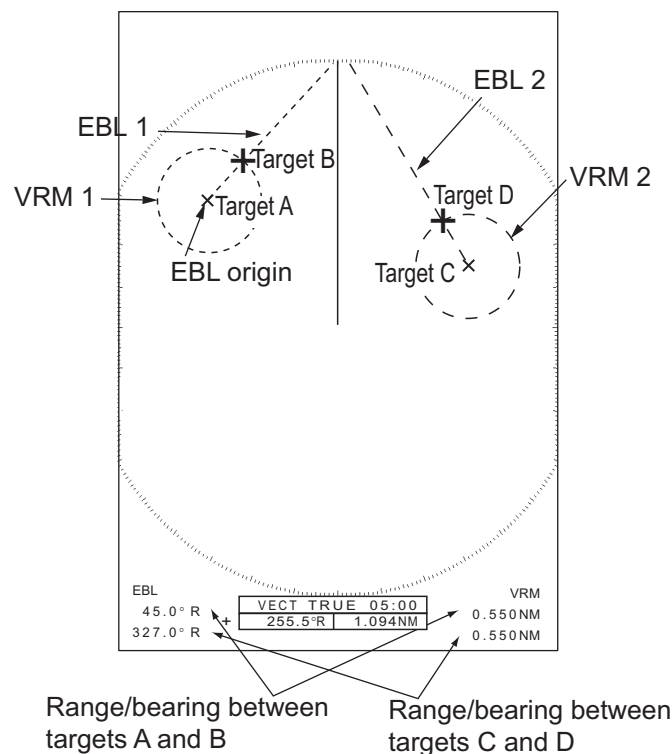

The range and bearing to another target (C and D in the figure above) can be measured using [EBL 2] and [VRM 2].

To cancel this function, turn off the EBL and VRM.

2.19 PI (Parallel Index) Lines

PI lines are useful for keeping a constant distance between own ship and a coastline or a partner ship when navigating. Up to six PI lines are available depending on the maximum number of PI lines selected on the menu.

You can control the presentation and interval of the PI lines from the [PI Lines] and [PI Line Mode] menu.

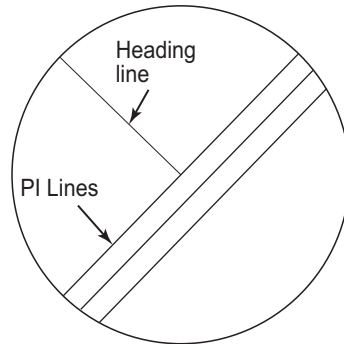

2.19.1 How to set the maximum number of lines to display

The maximum number of PI lines to display can be selected from [Off], [2], [3] or [6] lines. The number of visible lines on display can be less depending on the line interval and selected display range.

1. Press the **MENU** key to open the menu.
2. Press **▲** or **▼** to select [Others], then press the **ENTER** key.
3. Press **▲** or **▼** to select [PI LINES], then press the **ENTER** key.
4. Press **▲** or **▼** to select [Off], [2], [3] or [6] then press the **ENTER** key.
When
5. Press the **MENU** key to close the menu.

2.19.2 How to change the PI line orientation

PI lines orientation can be selected from parallel or perpendicular. This function is available when [PI LINES] menu is set to other than [1].

1. Press the **MENU** key to open the menu.
2. Press **▲** or **▼** to select [Others], then press the **ENTER** key.
3. Press **▲** or **▼** to select [PI LINES], then press the **ENTER** key.
4. Press **▲** or **▼** to select [Parallel], [Perpendicular] or [Both] then press the **ENTER** key.

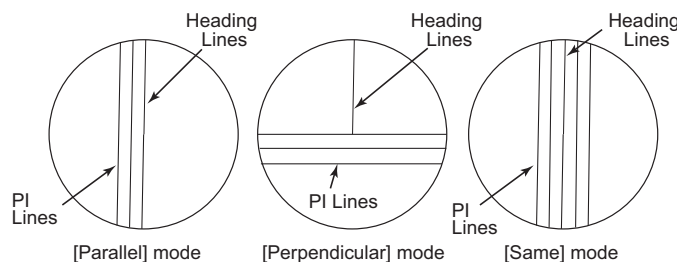

5. Press the **MENU** key to close the menu.

2.19.3 How to change PI line bearing and interval

1. Press the **EBL** to show [EBL2].
2. Adjust the PI line bearing with the cursorpad.
3. Press the **VRM** to show [VRM2].
4. Adjust the PI line interval with the cursorpad.

2.20 Tuning/Channel

For magnetron radars, the radar receiver can be tuned automatically after turning the radar to TX. The default setting is auto-tune. However, if manual tuning is required, proceed as follows:

2.20.1 Tuning mode (X-Class series, DRS4DL+)

1. Set the radar in transmit state, then select the maximum range with the **RANGE** knob.
2. Press the **MENU** key to open the menu.
3. Select [Tuning/Channel], then press the **ENTER** key.

Menu	Tuning/Channel
Brill/Color	Tuning Mode : Auto
Display	Manual Tuning : 0
Echo	Tune Initialize
Custom 1	TX Channel : Auto
Custom 2	
Custom 3	
Alert Settings	
Trails	
Tuning/Channel	
Others	
OS/Barge Mark	
Target	[ENTER]: Enter [CANCEL/HL OFF]: Back
TT	[MENU]: Exit
Select the TX Channel where interference is smallest	

4. Select [Tuning Mode], then press the **ENTER** key.
Note: The factory default is [Auto]. Use the tuning mode as [Auto] normally. Change it only when setting to [Manual] is required.

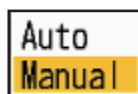

5. Select [Manual], then press the **ENTER** key.
6. Select [Manual Tuning], then press the **ENTER** key to show the manual tuning setting window.

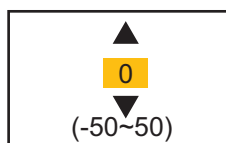

7. Use the cursorpad to adjust the tuning while you look at the tuning bar at the upper-right corner of the display. The best tuning point is where the tuning bar moves

2. OPERATION

to maximum value. The vertical bar on the tuning bar shows the tuning voltage. It is normal when the bar swings to a maximum of 80%.

8. Press the **ENTER** key.
9. Press the **MENU** key to close the menu.

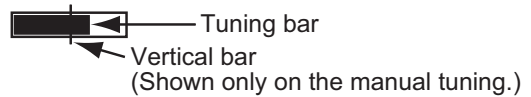

Note: If the automatic tuning does not give the correct tuning, select [Tune Initialize].

2.20.2 TX channel selection (Available only for the DRS-NXT series radar sensor)

In the default setting, the best TX channel is automatically selected at random among three channels. However, if interference is received from the radar of a nearby ship, select a different TX channel, the one least affected by outside interference.

1. Press the **MENU** key to open the menu.
2. Select [TX Channel], then press the **ENTER** key.
3. Select [Tuning Channel], then press the **ENTER** key.
4. Select [Auto], [1], [2] or [3], then press the **ENTER** key.
5. Press the **MENU** key to close the menu.

2.21 How to Select a Pulselength

The pulselength in use appears at the upper-left position on the screen. The pulselengths are set to each range scale and custom setup. You can change the pulselength on the several ranges with the following procedure. Pulselength cannot be changed on other ranges. (You can change the pulselength on the 2 nm or 4 nm range in the [Russian-River] mode.) Use a wider pulse when your purpose is long range detection. Use a narrower pulse when the resolution is important.

Note 1: When the DRS4DL+ is connected, this menu is not available.

Note 2: Press the **CUSTOM** key several times to activate the [Echo] menu until the [CS 1] (2, 3) indication (custom setting) disappears from the screen.

1. Press the **MENU** key to open the menu.
2. Use **▲** or **▼** to select [Echo] and press **ENTER**.

Menu	Echo
Brill/Color	Gain Mode : Manual
Display	Sea Mode : Manual
Echo	Auto Sea : Advanced
Custom 1	Rain Mode : Manual
Custom 2	Auto Rain : Moderate
Custom 3	A/C Auto : Off
Alert Settings	Pulse Width : Normal
Trails	Echo Stretch : 3
Tuning/Channel	Echo Average : 3
Others	
OS/Barge Mark	Int Rejector : On
Target	[ENTER]: Enter [CANCEL/HL OFF]: Back
TT	[MENU]: Exit
Select a pulse width	

- Use ▲ or ▼ to select [Pulse Length] and press **ENTER**.

Note: For DRS4DL+, this step is not available.

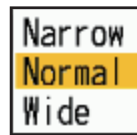

- Use ▲ or ▼ to select [Short] or [Long] then press **ENTER**. The pulselength indication at the upper-left corner changes according to your selection as shown below.

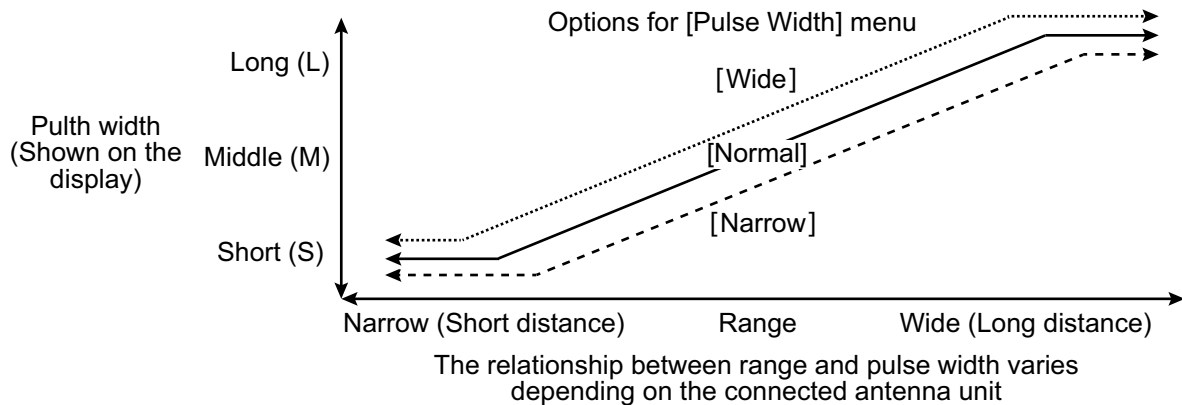

- Press the **MENU** key to close the menu.

2.22 Echo Stretch

The echo stretch feature enlarges the targets in the range and bearing directions to make the targets easier to see. This feature is available on any range. There are three levels of echo stretch, [1], [2] and [3]. [3] enlarges the targets the most.

Note: The echo stretch magnifies the targets, sea and rain clutters, and radar interference. Correctly adjust the sea clutter, rain clutter and radar interference before you activate the echo stretch.

- Press the **MENU** key to open the menu.
- Press ▲ or ▼ to select [Echo], then press the **ENTER** key.
- Press ▲ or ▼ to select [Echo Stretch], then press the **ENTER** key.

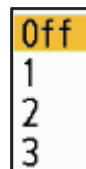

- Press ▲ or ▼ to select an echo stretch option, then press the **ENTER** key.
- Press the **MENU** key to close the menu. When the echo stretch is active, "ES 1 (2, or 3)" appears at the lower-left corner on the display.

2.23 Echo Average

To identify true target echoes from the sea clutter, echoes are averaged over successive picture frames. If an echo is solid and stable, the echo is shown in its normal intensity. The brilliance of sea clutter is reduced to easily identify true targets from the sea clutter.

Note 1: Do not use the echo average function under heavy pitching and rolling. You can lose a target.

Note 2: This feature requires a heading signal and position data. When either signal becomes lost, echo average is deactivated.

To correctly use the echo average function, first reduce the sea clutter:

1. Press the **MENU** key to open the menu.
2. Press ▲ or ▼ to select [Echo], then press the **ENTER** key.
3. Press ▲ or ▼ to select [Echo Average], then press the **ENTER** key.

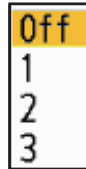

4. Press ▲ or ▼ to select an echo averaging option, then press the **ENTER** key.
[Off]: Deactivate the echo average.
[1]: Identify true targets from the sea clutter and reduce the brilliance of unstable echoes.
[2]: Identify true targets from the sea clutter that you cannot reduce the brilliance with setting 1.
[3]: Identify true targets from the sea clutter that you cannot reduce the brilliance with setting 1 or 2.
5. Press the **MENU** key to close the menu. The selected echo average ("EAV 1", "EAV 2" or "EAV 3") appears at the lower-left corner of the display.

2.24 Interference Rejector

Radar interference can occur when your ship is near the radar of another ship that operates on the same frequency band with your radar. The interference shows on the screen as many bright dots. The dots can be random or in the shape of dotted lines that run from the center to the edge of the display. You can identify the interference from the normal echoes, because the interference does not appear in the same location at the next antenna rotation. When this feature is turned on, "IR" appears at the lower-right corner.

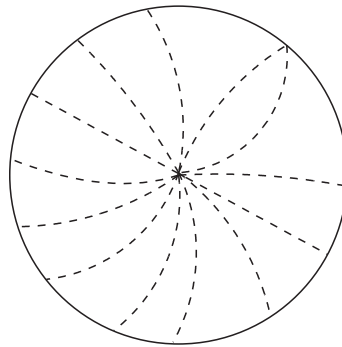

1. Press the **MENU** key to open the menu.
 2. Press **▲** or **▼** to select [Echo], then press the **ENTER** key.
 3. Press **▲** or **▼** to select [Int Rejector], then press the **ENTER** key.
 4. Press **▲** or **▼** to select [Off] or [On] then press the **ENTER** key.
 5. Press the **MENU** key to close the menu.
- Note:** Normally, [Int Rejector] should be set to [On] (Factory default).

2.25 Dynamic Range

You can change the dynamic range to erase unwanted weak echoes (sea reflections, etc.). Select [Narrow], [Normal] or [Wide] depending on conditions.

[Display-Dynamic] menu is not available when the DRS4DL+ is connected.

1. Press the **MENU** key to open the menu.
2. Use **▲** or **▼** to select [Echo] and press the **ENTER** key.
3. Use **▲** or **▼** to select [Display-Dynamic] and press the **ENTER** key.

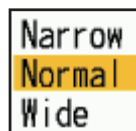

4. Use **▲** or **▼** to select [Narrow], [Normal] or [Wide] then press the **ENTER** key.
 - [Narrow]:** Erase weak echoes.
 - [Normal]:** Normal use
 - [Wide]:** Display weaker echoes.
5. Press the **MENU** key to close the menu.

2.26 Display-Curve

You can change the characteristics curve to reduce unwanted weak echoes (sea reflections, etc.). Select [1], [2] or [3] depending on conditions when unwanted weak echoes hide wanted targets.

1. Press the **MENU** key to open the menu.
2. Press ▲ or ▼ to select [Echo], then press the **ENTER** key.
3. Press ▲ or ▼ to select [Display-Curve], then press the **ENTER** key.



4. Press ▲ or ▼ to select [1], [2] or [3] then press the **ENTER** key.
 - [1]: Reduce weak echoes.
 - [2]: Normal use
 - [3]: Display weaker echoes in stronger color.

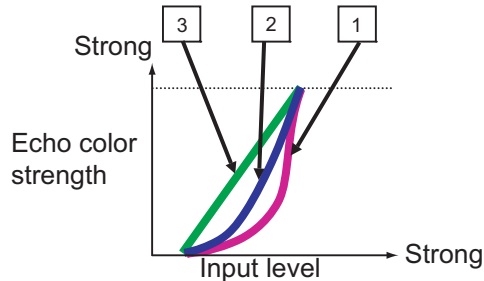

5. Press the **MENU** key to close the menu.

2.27 How to Erase the Low Level Echoes

You can erase low level echoes. The higher the setting the more low level echoes are erased.

1. Press the **MENU** key to open the menu.
2. Press ▲ or ▼ to select [Echo], then press the **ENTER** key.
3. Press ▲ or ▼ to select [Low Level Echo], then press the **ENTER** key.
4. Press ▲ or ▼ to select [1] to [8] then press the **ENTER** key.

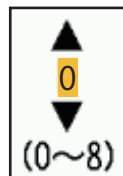

5. Press the **MENU** key to close the menu.

2.28 Target Analyzer™

The Target Analyzer™ analyzes echoes and displays targets in different colors to help you distinguish targets that are moving and approaching own ship. Use this function to distinguish targets from heavy rain or snow.

Note 1: Requires GPS position data and one of the following radar sensors. DRS2D-NXT/DRS4D-NXT/DRS6A-NXT/DRS12A-NXT/DRS25A-NXT

Note 2: [Radar Adjust] (Gain, Sea, Rain) and [Auto Sea Mode] cannot be adjusted when the Target Analyzer™ is active.

Note 3: The Target Analyzer™ works only against moving targets. Stationary targets, such as a buoy, are not identified as an approaching target.

Note 4: When the radial component* of target velocity (see below for description) is 50 kn or higher, the target may be painted in a wrong color. For example, an approaching target whose speed is 50 kn or higher should be painted in red, but is painted in green.

* **Radial component of target velocity:** The target velocity can be separated into two components, the radial and transverse components, as in the figure below. The radar is only able to sense the motion directly along the radial, either towards or away from the radar, because the transverse component has no effect on the phase of the returning electromagnetic wave.

1. Press the **MENU** key to open the menu.
2. Press **▲** or **▼** to select [Echo], then press the **ENTER** key.
3. Press **▲** or **▼** to select [Target Analyzer], then press the **ENTER** key.
4. Press **▲** or **▼** to select [On] then press the **ENTER** key. Select [Off] to disable the Target Analyzer™.
5. Press the **MENU** key to close the menu.

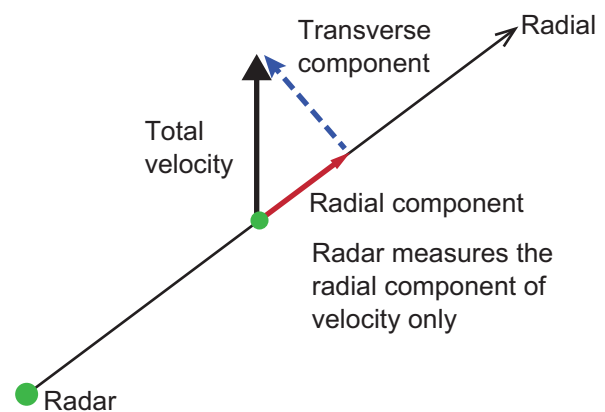

2.29 Target Analyzer™ Mode

The Target Analyzer mode sets how the Target Analyzer™ processes radar echoes, and the choices are [Target] and [Rain]. Use [Target] to remove echoes from rain or snow, or when you want to adjust the gain manually. Select [Rain] to display color-coded rain and snow echoes, to help distinguish them from actual targets. When the [Rain] is selected, Range, Sensitivity, Sea clutter, Rain/Snow clutter works as [Auto] regardless of the setting.

Settings	Echo Colors
Off	The color set on the [Brill/Color] (See section 2.36 for details.)
Target	Approaching target: RED/Other Echoes: GRN
Rain	Approaching target: RED/Rain/Snow clutter: BLU/Other Echoes: GRN

1. Press the **MENU** key to open the menu.
2. Press **▲** or **▼** to select [Echo], then press the **ENTER** key.
3. Press **▲** or **▼** to select [Target Analyzer Mode], then press the **ENTER** key.
4. Press **▲** or **▼** to select [Target] or [Rain] then press the **ENTER** key.

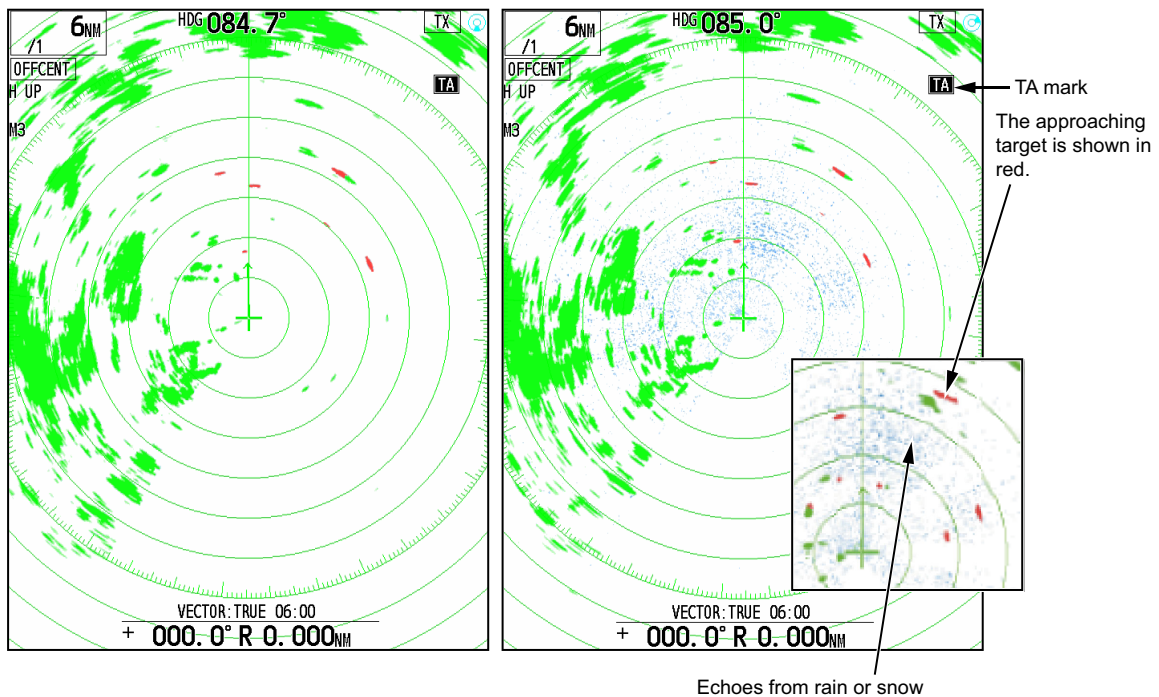

5. Press the **MENU** key to close the menu.

2.30 RezBoost™

RezBoost™ provides advanced signal processing to achieve higher resolution images. This feature sharpens the apparent beam width and improves azimuth resolution. Increasing the setting value makes the object boundaries sharper.

Note: For DRS4DL+, DRS X-class, this function is unavailable.

1. Press the **MENU** key to open the menu.
2. Press **▲** or **▼** to select [Echo], then press the **ENTER** key.

3. Press ▲ or ▼ to select [RezBoost], then press the **ENTER** key.
4. Press ▲ or ▼ to select [1], [2] or [3] then press the **ENTER** key.
When select [3], the apparent resolution is highest.
When select [Off], this function will not start.
5. Press the **MENU** key to close the menu.

2.31 Custom Setup

2.31.1 About custom setup

When your navigating environment or task changes, you must adjust the radar. Instead of changing radar settings case by case, you can assign the **CUSTOM** key to provide best settings for common conditions.

There are three default custom setups for the internal computer of the radar. You can adjust these settings on the [Custom 1], [Custom 2] and [Custom 3] menus to meet your navigation needs.

To activate a custom setup, press the **CUSTOM** key. The **CUSTOM** key switches between Custom 1, Custom 2 or Custom 3 each time you press the key (Custom setup numbers which are turned off are ignored). The selected custom setup name is shown at the upper-left corner. To escape from custom setup, operate any control.

Note 1: The [Echo] menu will be unavailable when displayed with the settings registered in [Custom1] to [Custom3]. The [Echo] menu will be available by continuously pressing the **CUSTOM** key to clear the setting displayed in the upper left corner of the screen.

Note 2: When you change the custom setup, "" is displayed at the end of the display of [Custom1] to [Custom1]. When the settings are saved, the "" mark disappears.

2.31.2 Description of custom setup items

Description of custom setup items

Menu item	Available settings	See section
[Custom1(2 or 3)]	Turn on/off each custom program.	section 2.31.3
[Copy]	Copy settings from the [Echo] menu. The message "Complete" appears after the copying is completed.	
[Save]	Save settings of [Custom1(2 or 3)].	
[Gain Mode]	[Auto]: Automatic gain adjustment according to noise level. [Manual]: Manual gain adjustment	section 2.10
[Manual Gain]	Copy the current position of the GAIN knob when you do [Copy]. This item is for read-only.	
[Sea Mode]	[Auto]: Automatic sea clutter adjustment according to sea state. [Manual]: Manual sea clutter adjustment.	section 2.11

2. OPERATION

Menu item	Available settings	See section
[Auto Sea]	[Coastal] : Suppress both land and sea clutter. [Advanced] : Automatically discriminate land echoes from sea clutter to suppress only sea clutter. [Channel] : Provides milder suppression of sea clutter than other modes, however, this mode emphasize the land.	section 2.11
[Manual Sea]	Copy the current position of the A/C SEA knob when you do [Copy]. This item is for read-only.	
[Rain Mode]	[Auto] : Automatic rain clutter adjustment according to rain cloud density. [Manual] : Manual rain clutter adjustment.	section 2.12
[Auto Rain]	[Calm] : For light rain. [Moderate] : When you can not reduce the rain clutter with [Calm] mode. [Rough] : For heavy rain.	section 2.12
[Manual Rain]	Copy the current position of the A/C RAIN knob when you do [Copy]. This item is for read-only.	
[A/C Auto]	[Off], [On]	section 2.13
[Pulse Length]	[Short] or [Long], you can select on 1.5 and 3.0 nm ranges.	section 2.21
[Echo Stretch]	[Off], [1], [2], [3]	section 2.22
[Echo Average]	[Off], [1], [2], [Auto]	section 2.23
[Int Rejector]	[Off], [1], [2], [3]	section 2.24
[Display-Dynamic]	[Narrow] : Erase weak echoes. [Normal] : Normal use. [Wide] : Display weaker echoes compared to [Narrow].	section 2.25
[Display-Curve]	[1] : Reduce weak echoes. [2] : Normal use. [3] : Display weaker echoes in stronger color compared to [1].	section 2.26
[Color Erase]	Erases colors from the weakest colors in the radar image. The higher the value, the more only strong echoes are displayed. [0] to [8].	section 2.27
[Target Analyzer]	Set Target Analyzer™ to [Off] or [On].	section 2.28
[T.A. Mode]	[Target] : Approaching targets are displayed in red, and other targets are displayed in green. [Rain] : Approaching targets are displayed in red, rain is displayed in blue, and other targets are displayed in green.	
[RezBoost]	Set RezBoost effect from [Off], [1], [2] or [3].	section 2.30

2.31.3 How to set custom setups

1. Press the **MENU** key to open the menu.
2. Use ▲ or ▼ to select [Custom 1 (2 or 3)] and press the **ENTER** key.
Note: Match the type displayed in the upper left of the screen.

Menu	Custom 1
Brill/Color	Custom 1 : Off
Display	Copy
Echo	Save
Custom 1	Gain Mode : Manual
Custom 2	Manual Gain : 80
Custom 3	Sea Mode : Manual
Alert Settings	Auto Sea : Advanced
Trails	Manual Sea : 0
Tuning/Channel	Rain Mode : Manual
Others	Auto Rain : Moderate
OS/Barge Mark	Manual Rain : 0
Target	[ENTER]: Enter [CANCEL/HL OFF]: Back
TT	[MENU]: Exit
Enable/Disable the custom settings	

- Set menu items.



Note 1: For easy set up, you can copy the settings of the [Echo] menu (to [Custom 1], [Custom 2] or [Custom 3]). Select [Copy] and press the **ENTER** key. When finished copying the settings, the message "Complete" appears. To erase this message, press any key.

Note 2: To save the settings of the [Echo] menu (to [Custom 1], [Custom 2], [Custom 3]). Select [Save] and press the **ENTER** key. When the saving is completed, the message "Complete" appears. To erase this message, press any key.

- Press the **MENU** key to close the menu.

2.32 Target Alarm

The target alarm looks for targets (ship, landmass, etc.) in the area you set. Audiovisual alarms are released when a target enters (or exits) the alarm area.

 CAUTION
 Do not depend on the alarm as the only means to detect possible collision situations.
 Adjust the A/C SEA, A/C RAIN and GAIN controls correctly so that the alarm system does not miss the target echoes.

2.32.1 How to set a target alarm zone

The following procedure shows you how to set a target alarm zone.

- Press the **TARGET ALARM** key to activate ALARM 1 or ALARM 2. Press the **TARGET ALARM** key again to change the active ALARM between No. 1 and No. 2. The currently active ALARM is indicated in a rectangle at the upper-right corner of the screen.
- Use the cursorpad to move the cursor to the position A, then press the **ENTER** key.

2. OPERATION

3. Move the cursor to the position B, then press the **ENTER** key. The rectangle that shows alarm status indication at the upper-right corner of the screen disappears.

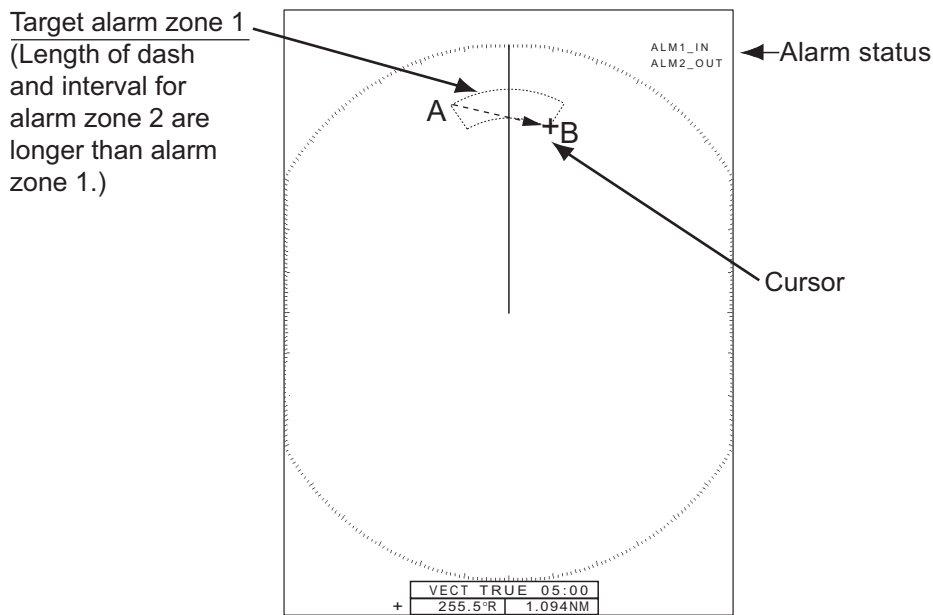

Note 1: To set a 360-degree guard zone, set the position B in the same bearing as the position A.

Note 2: If the alarm range is out of the display range of the screen by reducing the distance range, the "ALM 1 (or 2)_IN (or OUT)" display at the upper right of the screen changes to "ALM 1 (or 2)_RNG". In this case, press the [+] key in the distance range to increase the distance range. Even if the alarm range is outside the display range of the screen, when the alarm range is displayed on the screen and move the maximum distance with the off-center function, the alarm range will not be out of range.

2.32.2 How to stop the audio alarm

When a target enters (or exits) the target alarm zone, the target flashes and the alarm sounds. The alarm message appears at the bottom of the screen. To stop the audio alarm, press any key. When the target enters (or exits) the target alarm zone again, the audio alarm sounds.

2.32.3 How to select the alarm type

You can set the target alarm to activate against targets entering or exiting the alarm zone.

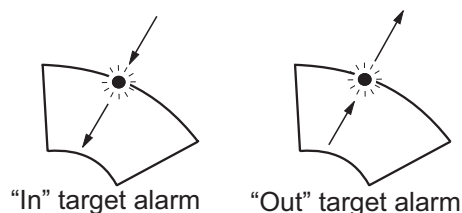

[In]: The alarm sounds against targets entering a target alarm zone.

[Out]: The alarm sounds against targets exiting a target alarm zone.

1. Press the **MENU** key to open the menu.

- Press ▲ or ▼ to select [Alert Settings], then press the **ENTER** key.

Menu	Alert Settings
Brill/Color	Target Alarm 1 : In
Display	Target Alarm 2 : In
Echo	Target Alarm Level : Middle
Custom 1	Watchman : Off
Custom 2	Panel Buzzer : Off
Custom 3	Alert Ext Output : Off
Alert Settings	Alert Status
Trails	
Tuning/Channel	
Others	
OS/Barge Mark	
Target	[ENTER]: Enter [CANCEL/HL OFF]: Back
TT	[MENU]: Exit

Select the target alarm type (inbound/outbound)

- Press ▲ or ▼ to select [Target Alarm 1] or [Target Alarm 2] then press the **ENTER** key.
- Press ▲ or ▼ to select [In] or [Out], then press the **ENTER** key.
- Press the **MENU** key to close the menu.

2.32.4 How to sleep a target alarm temporarily

When you do not require a target alarm temporarily, you can sleep the target alarm. The alarm zone remains on the screen, but any targets that enter (or exit) the alarm zone do not trigger the audio and visual alarms.

- Press the **TARGET ALARM** key to select the ALARM 1 or ALARM 2 indication at the upper-right corner on the screen. The selected indication is in a rectangle.
- Press the **CANCEL/HL OFF** key. The alarm zone is now slept.

Note: To reactivate a sleeping target alarm zone, press the **TARGET ALARM** key to select the required alarm, then press the **ENTER** key. "ALM 1 (or 2)_IN (or OUT)" display at the upper right of the screen.

2.32.5 How to deactivate a target alarm

- Press the **TARGET ALARM** key to select the ALARM 1 or ALARM 2 indication at the upper-right corner on the screen. The selected indication is in a rectangle.
- Press the **MENU** key.
- Press the **TARGET ALARM** key. The alarm indication is shown in a blue.
- Press the **MENU** key. The target alarm zone and the alarm indication are erased from the screen.

2.32.6 How to select the target strength which triggers a target alarm

You can select the target strength which triggers the target alarm as follows:

- Press the **MENU** key to open the menu.
- Press ▲ or ▼ to select [Alert Settings], then press the **ENTER** key.

2. OPERATION

- Press ▲ or ▼ to select [Alarm Level], then press the **ENTER** key.
When the alarm level is set to "Low", the alarm is likely to occur, and when it is set to "High", the alarm is less likely to occur.

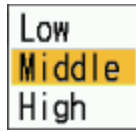

- Press ▲ or ▼ to select the echo strength level, among [Low], [Middle] and [High].
- Press the **ENTER** key followed by the **MENU** key.

2.33 Watchman

The Watchman sounds the buzzer to tell the operator to check the radar display. The radar transmits for one minute and then goes into standby for the selected time interval. If the target alarm is active and a target is found in the alarm zone, Watchman is canceled, and the radar transmits continuously.

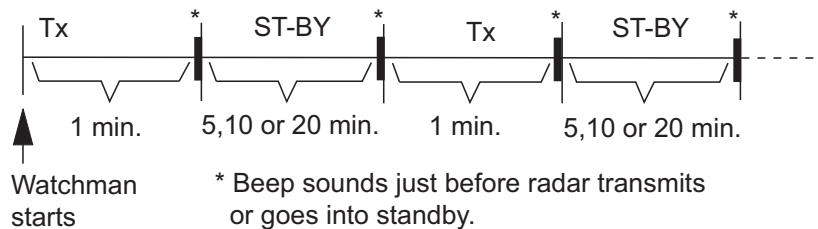

When this function is set, after approximately one minute of transmission, the unit will be in standby, an alarm sounds, and the Watchman symbol (shown at right) appears.



In standby, the timer near the <WATCH> label at the center of the screen counts down the remaining time until the transmission. When the set time interval has passed, the audio alarm sounds, the timer disappears and the radar transmits for one minute. After one minute, the audio alarm sounds and the watch alarm timer again begins the count-down sequence.

If you press the **STBY/TX** key before the set time interval comes, the radar goes into transmission.

Note 1: If an echo is detected entering the watch alarm area or the automatic acquisition area echoes entering the watch alarm area or the automatic acquisition area, the watchman will automatically turn off and the radar will transmit continuously.

Note 2: This function is not available when sub display (independent) is connected to the antenna unit.

Do the following to activate the Watchman:

- Press the **MENU** key to open the menu.
- Press ▲ or ▼ to select [Alarm], then press the **ENTER** key.
- Press ▲ or ▼ to select [Watchman], then press the **ENTER** key.
- Press ▲ or ▼ to select [Off] or a time ([5min], [10min] or [20min]) then press the **ENTER** key.
- Press the **MENU** key to close the menu.

To turn the watchman feature off, select [Off] at step 4.

2.34 How to Turn the Buzzer On/Off

You can turn on/off the panel buzzer or external buzzer for target alarms. The panel buzzer is for this equipment. The external buzzer is for the optional buzzer, which is connected to this equipment to give the target alarm at a remote location.

1. Press the **MENU/ESC** key to open the menu.
2. Select [Alarm], then press the **ENTER** key.
3. Select [Panel Buzzer] (or [External Buzzer] for optional buzzer), then press the **ENTER** key.
4. Select [On] or [Off] then press the **ENTER** key.
5. Press the **MENU/ESC** key to close the menu.



2.35 Alert Status

The alert status window shows all currently violated alarms and system messages.

Note: The alert status window is not automatically displayed when an alarm occurs.

1. Press the **MENU/ESC** key to open the menu.
2. Select [Alert Settings], then press the **ENTER** key.
3. Select [Alert Status], then press the **ENTER** key.

Alert Status	
[SIGNAL MISSING]	[101] HEADING
	[102] BEARING
	[103] TRIGGER
	[104] VIDEO
	[105] ANT_COM_ERROR
	[106] HDG
	[107] POSITION
	[108] COG/SOG
	[109] RP_COM_ERROR
	[110] HDG_ON_LAN
[TARGET ALARM 1]	[201] IN
	[202] OUT
[TARGET ALARM 2]	[301] IN
	[302] OUT
[TT ALERT]	[401] PROXIMITY
	[402] RISK VISUALIZER
[↑/↓]: Scroll [CANCEL/HL OFF]: Close	

Alert Status display

4. Press the **MENU/ESC** key to close the [Alert Status] display.
5. Press the **MENU/ESC** key to close the menu.

2.36 Color Selections

2.36.1 Preset colors

This radar is preset with color combinations that provide best viewing in daytime, nighttime and twilight. The table below shows the default color settings

Display item	Day	Night	Twilight	Custom
Characters	Black	Red	Green	Green
Range rings, marks	Green	Red	Green	Green
Echo	Yellow	Green	Green	Yellow
Background	White	Black	Blue	Black

1. Press the **MENU** key to open the menu.
2. Press ▲ or ▼ to select [Brill/Color], then press the **ENTER** key.
3. Press ▲ or ▼ to select [Display Color], then press the **ENTER** key.



4. Press ▲ or ▼ to select the color design, then press the **ENTER** key.
5. Press the **MENU** key to close the menu.

2.36.2 Custom colors

The custom color design lets you select preferred echo, background, characters, range rings and marks colors. Select [Custom] in the [Display Color] menu item (see subsection 2.36.1) to use the user selected echo, background, characters, range rings and marks colors.

1. Press the **MENU** key to open the menu.
2. Press ▲ or ▼ to select [Brill/Color], then press the **ENTER** key.
3. Press ▲ or ▼ to select [Echo Color], then press the **ENTER** key.



4. Press ▲ or ▼ to select an echo color, then press the **ENTER** key. [Multi] displays echoes in colors of red, yellow and green according to descending echo strength.
5. Press ▲ or ▼ to select [Background Color], then press the **ENTER** key.

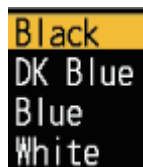

6. Press ▲ or ▼ to select a background color, then press the **ENTER** key.

7. Press ▲ or ▼ to select [Character Color], then press the **ENTER** key.



8. Press ▲ or ▼ to select a character color (including range rings and marks), then press the **ENTER** key.
9. Press the **MENU** key to close the menu.

2.36.3 Brill/Color menu

You can customize the display mark, character or display colors.

Brill/Color menu

Menu item	Descriptions
[Echo Brill]	Adjust the brilliance of echoes.
[Rings Brill]	Adjust the brilliance of the range rings.
[Mark Brill]	Adjust the brilliance of all marks.
[HL Brill]	Adjust the brilliance of the heading line.
[Character Brill]	Adjust the brilliance of all characters.
[Trail Brill]	Adjust the brilliance of trails.
[L/L Grid Brill] ^{*1}	Adjust the brilliance of L/L grid.
[Chart Brill] ^{*1} :	Adjust the brilliance of chart.
[Plotter Brill] ^{*1}	Adjust the brilliance of plotter.
[Depth Line Brill] ^{*1}	Adjust the brilliance of depth lines.
[Viewing Position]	Adjust the viewing position between the installation position and user. Note 1: When the [Echo Color Mode] is set to [System], not changes the echo color but changes the trail color. Note 2: Available only for FR-10 (not required for FR-12).
[Display Color]	Adjust the display color (Setting range: [Day], [Night], [Twilight], [Custom]).
[Echo Color] ^{*2*3}	Adjust the echo color (Setting range: [Yellow], [Green], [Orange], [Multi]).
[Background Color] ^{*2}	Adjust the background color (Setting range: [Black], [DK Blue], [Blue], [White]).
[Character Color] ^{*2} :	Adjust the character color (Setting range: [Green], [Red], [White]).
[Menu Transparency]	You can select the degree of transparency of the menu window so the menu window does not hide the echo display.
[Echo Color Mode] ^{*3}	You can select the color palette from [System] or [Custom].

2. OPERATION

Menu item	Descriptions
[Custom Echo Color] ^{*3}	You can customize the echo color.

*1: Available only for FR-12 (When the optional RP board is in use).

*2: Available only when the [Display Color] sets to [Custom].

*3: Unavailable when the [Target Analyzer] sets to [On] in DRS-NXT series radar.

[Viewing Position]

Adjust the viewing position between the installation position and user. See below figure.

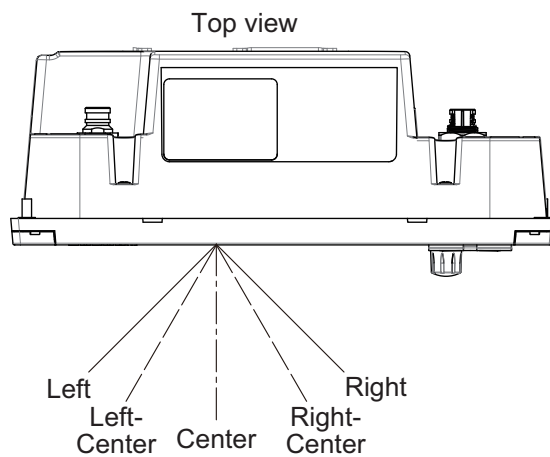

[Menu Transparency]

You can select the degree of transparency of the menu window so the menu window does not hide the echo display. [4] is the greatest degree of transparency. [Off] functions to hide the echo display behind the menu window completely.

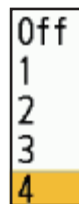

[Echo Color Mode]

You can select the color palette from [System] or [Custom]. [System] is the preset color palette and [Custom] is the color palette you can set yourself. This function is not available in the [IEC] or [Russian-River] mode.

[Custom Echo Color]

You can customize the echo color with the following two methods.

- **Method 1:**

- 1) Select the echo rank to change on the [Rank] (setting range: 1 - 31).
- 2) Set the RGB values for selected echo rank on the [Red], [Green] and [Blue] (setting range: 0 - 255).

- **Method 2:**

- 1) Select [31] on the [Rank].
- 2) Set the RGB values for 31 echo rank on the [Red], [Green] and [Blue] (setting range: 0 - 255).
- 3) Interpolate the RGB values between the maximum rank and minimum rank on the [Fitting To Curve] with the following curves (setting range: -20 to 20).
 - Setting range > 0: Logarithmic curve, useful to emphasize the weak echoes.
 - Setting range = 0: Straight line
 - Setting range < 0: Exponential curve, useful to emphasize the strong echoes.

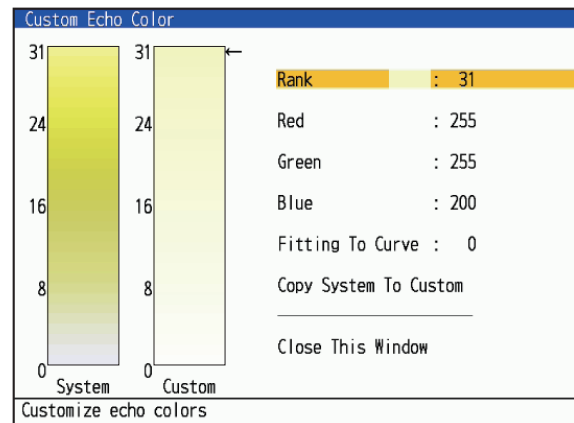

[Copy To Custom]: Copy the color palette from [System] to [Custom].

2.37 How to Off-center the Display

You can off-center your ship position to expand the view field without selecting a larger range scale. The display can be off-centered manually, or user settings according to speed of the ship.

Note: Off-centering is not available in the true motion mode.

2.37.1 How to select the off-center mode

1. Press the **MENU** key to open the menu.
2. Press **▲** or **▼** to select [Display], then press the **ENTER** key.
3. Press **▲** or **▼** to select [Off-center mode], then press the **ENTER** key.



4. Press **▲** or **▼** to select [Manual] or [Custom] then press the **ENTER** key. Press the **ENTER** key again to change between on and off.
5. Press the **MENU** key to close the menu.

2.37.2 How to off-center the display

Manual off-center

You can move your ship position to the current cursor position on all modes except true motion, within 75% of the available display area.

1. Put the cursor on the position where to off-center the display.

2. OPERATION

2. Press the **OFF CENTER** key.
Your ship position moves to the current cursor position.
3. Press the **OFF CENTER** key again to deactivate the function.

Custom off-center

You can move your ship position to the position which you preset. Follow the procedure shown below to register the cursor position.

1. Turn off the off-center display and put the radar in transmit (TX) mode.
2. Put the cursor on the position where to off-center the display.
3. Press the **MENU** key to open the menu.
The menu window automatically closes.
Note: When the [Off-center mode] is set to [Manual], this setting is not available.
4. Press **▲** or **▼** to select [Display], then press the **ENTER** key.

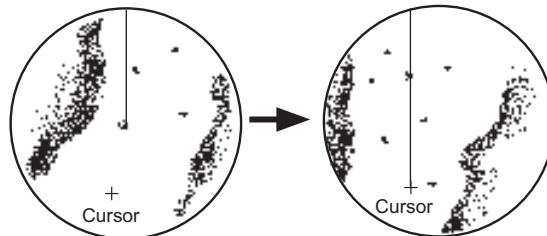

Put cursor where desired
and do appropriate
off-center procedure.

Off-centered display

5. Press **▲** or **▼** to select [Save Offcenter] and select [Yes] or [No], then press the **ENTER** key.
When selecting [Yes], the cursor position is confirmed as the off-center position.
Select [No] to return to the state of setting the off-center position (step 4).

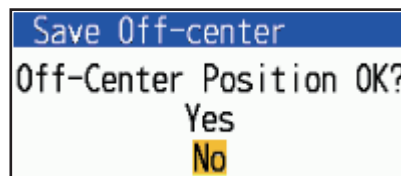

6. Press any key to close the message window.
7. Press the **MENU** key to close the menu.

2.38 Zoom

The zoom function expands the length and width of a selected target as much as twice its normal size, in the zoom window. You select the target to zoom with the zoom cursor. The selected target is zoomed in the zoom window.

TT and AIS symbols can be displayed in the zoom window, but are not zoomed. You can process TT and AIS targets that are in the zoom window, in the same method as on the normal radar display.

2.38.1 Zoom reference

There are three types of zoom.

- [Relative]: The zoom cursor is fixed to the range and bearing from your ship. Shown as “(R)” on the top left of the screen.
 - [True]: The zoom cursor is fixed to set geographical position. Shown as “(T)” on the top left of the screen.
 - [Target]: The zoom cursor is fixed to the zoomed AIS or TT target. Shown as “(A)” on the top left of the screen.
1. Press the **MENU** key to open the menu.
 2. Press **▲** or **▼** to select [Display], then press the **ENTER** key.
 3. Press **▲** or **▼** to select [Zoom Reference], then press the **ENTER** key.

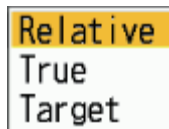

4. Press **▲** or **▼** to select [Relative], [True] or [Target] then press the **ENTER** key.
Note: True zoom mode requires a heading signal and position data.
5. Press the **MENU** key to close the menu.

2.38.2 How to zoom

Relative or True zoom mode

1. Use the cursorpad to put the cursor on the position desired.
2. Press the **MENU** key to open the menu.
3. Select [Display], then press the **ENTER** key.
4. Select [Zoom], then press the **ENTER** key.



5. Select [On], then press the **ENTER** key.
The ZOOM indication appears at the upper-left corner on the screen. The zoom window and the zoom cursor also appear (see the illustration on the next page).
To quit the zoom, select [Off] instead of [On], then press the **ENTER** key.

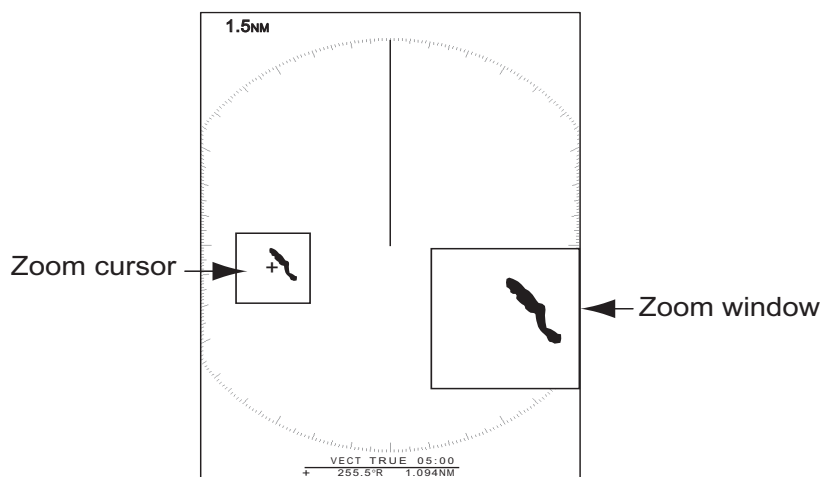

2. OPERATION

6. Press the **MENU** key to close the menu.

Target (AIS, TT) zoom mode

The TT or AIS target as below can be displayed in the zoom window:

- TT: The symbol is enlarged twice its normal size.
- AIS: The symbol is enclosed in a broken square. (The symbol is not enlarged.)

The zoom cursor moves with the TT or AIS target.

Note: If neither TT nor AIS targets are selected, the message "NO TARGET." appears. Press any key to erase the message.

1. Press the **MENU** key to open the menu.
2. Press **▲** or **▼** to select [Display], then press the **ENTER** key.
3. Press **▲** or **▼** to select [Zoom], then press the **ENTER** key.
4. Press **▲** or **▼** to select [On], then press the **ENTER** key.

The ZOOM indication appears at the upper-left corner on the screen. The zoom window and the zoom cursor also appear (see the following illustration). To quit the zoom, select [Off] instead of [On], then press the **ENTER** key.

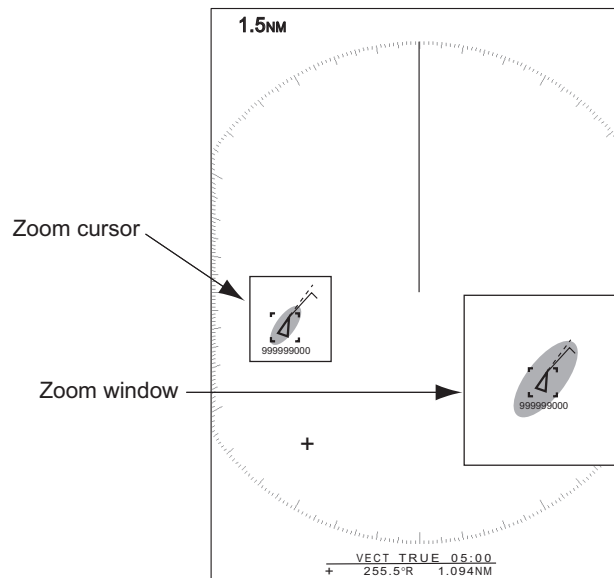

Target zoom mode
(example: AIS)

5. Press the **MENU** key to close the menu.

2.39 Echo Area

You can select the display area from [Normal] or [Full Screen].

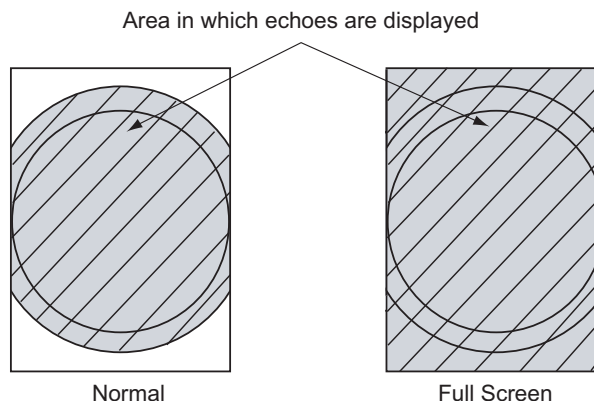

1. Press the **MENU** key to open the menu.
2. Press **▲** or **▼** to select [Display], then press the **ENTER** key.
3. Press **▲** or **▼** to select [Echo Area], then press the **ENTER** key.



4. Press **▲** or **▼** to select [Oval] or [Full Screen] then press the **ENTER** key.
5. Press the **MENU** key to close the menu.

2.40 Display Menu

[Text Display]: You can select on/off for the text indications of the following items on the display. The settings on this function are used when you set [Echo Area] to [Full Screen] on the [Display] menu.

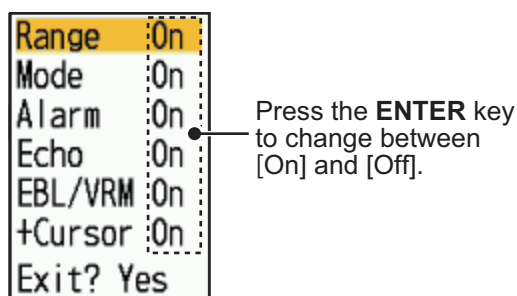

The text indications set to off appear when you operate any key. The indications disappear when there is no key operation for ten seconds.

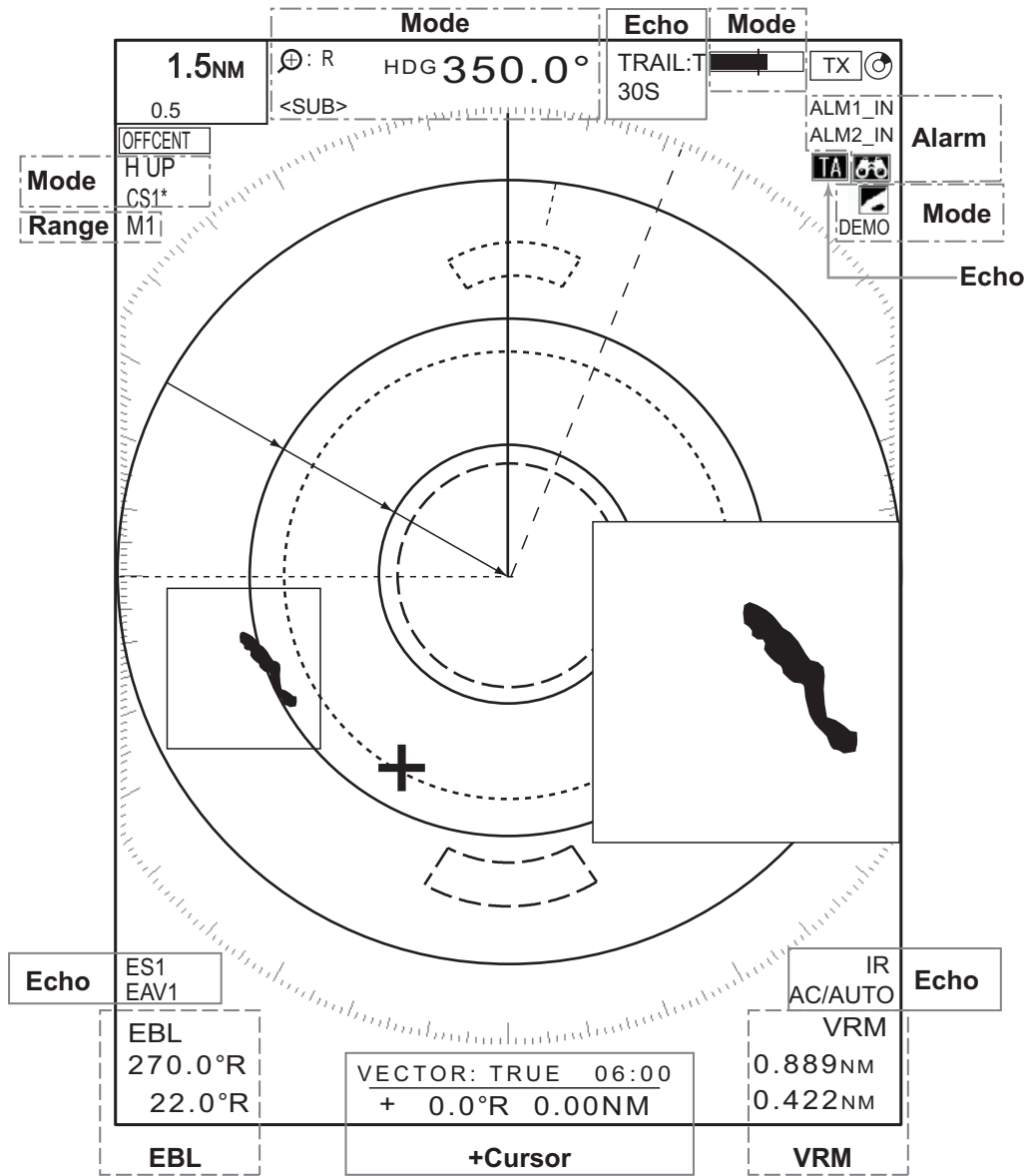

2.41 Navigation Data

Navigation data can be displayed at the bottom of the screen. The figure below shows the navigation data display

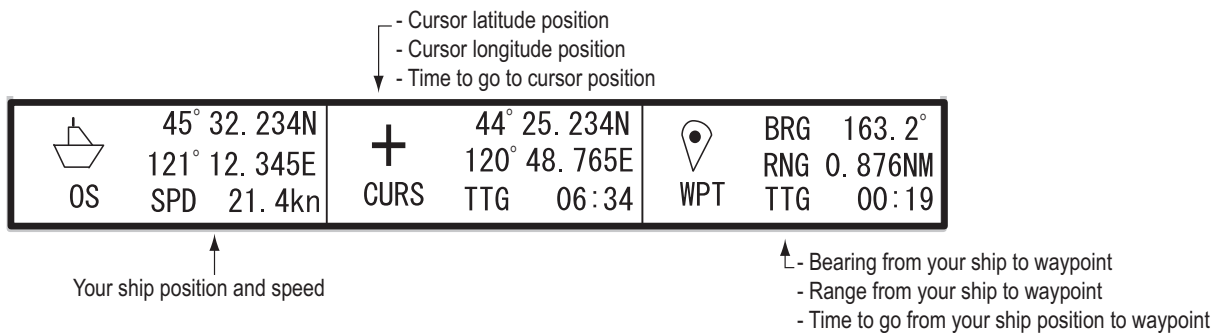

1. Press the **MENU** key to open the menu
2. Press **▲** or **▼** to select [Display], then press the **ENTER** key.

3. Press ▲ or ▼ to select [Data Box], then press the **ENTER** key.

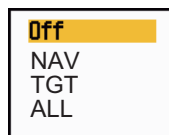

4. To show or hide the navigation data at the bottom of the screen, operate the **DATA BOX** knob to select [OFF], [NAV], [TGT] or [ALL].
 [OFF]: Turn off the data box display.
 [NAV]: Navigation data
 [TGT]: TT, AIS and other ship's data (see section 4.11, section 5.4.)
 [ALL]: Navigation data plus TT and AIS target data
5. Press the **MENU** key to close the menu.

2.42 How to Send the Target Position and Enter the Origin Mark

The **TLL** function sends the cursor position to a chart plotter and put an origin mark () at the cursor position on the radar. Use the cursorpad to put the cursor on a target. Press the **MODE** key to open the [Mode] window, select [TLL] then press the **ENTER** key. You can enter up to 20 origin marks on the radar display. When the capacity for origin marks is reached, the oldest mark is erased to make room for the latest mark, to keep a maximum of 20 marks. To erase a mark, put the cursor on the mark, then press the **MENU** key.

TLL mode

You can select how to handle TLL position.

1. Press the **MENU** key to open the menu.
2. Press ▲ or ▼ to select [Others], then press the **ENTER** key.
3. Press ▲ or ▼ to select [TLL Mode], then press the **ENTER** key.

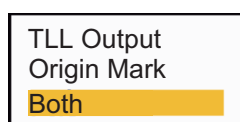

4. Press ▲ or ▼ to select [TLL Output], [Origin Mark] or [Both] then press the **ENTER** key.
 [TLL Output]: Send the latitude and longitude of the cursor position to a chart plotter. (Position and heading signal are required.)
 [Origin Mark]: Enter an origin mark at the cursor position on the radar display. (Position and heading signal are required.)
 [Both]: Send the target position to a chart plotter and enter an origin mark on the radar display.
5. Press the **MENU** key to close the menu.

Note: All origin marks are deleted and not saved when the power is turned off.

2.43 Waypoint Mark

The waypoint mark shows the location of the destination waypoint set on a navigation plotter. The heading signal or course data are required. You can turn on/off the waypoint mark as follows:

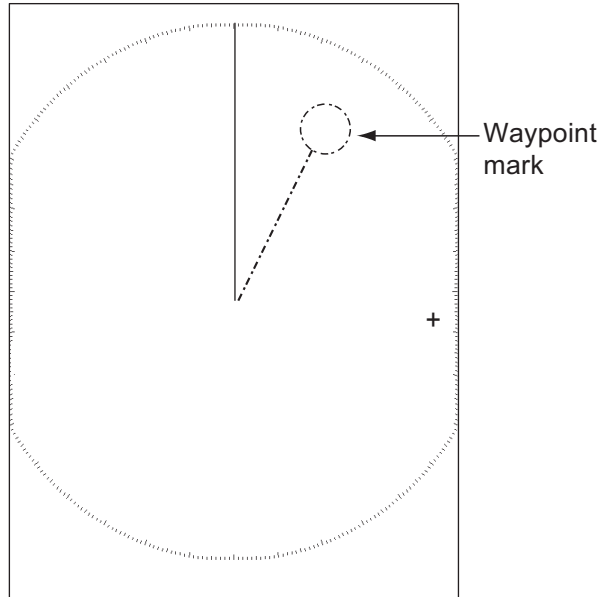

1. Press the **MENU** key to open the menu.
2. Press **▲** or **▼** to select [Others], then press the **ENTER** key.
3. Press **▲** or **▼** to select [WPT Mark], then press the **ENTER** key.
4. Press **▲** or **▼** to select [Off] or [On] then press the **ENTER** key.
5. Press the **MENU** key to close the menu.

2.44 Own Ship and Barge Mark

This section shows you how display and set up the own ship and barge marks.

2.44.1 How to show the own ship mark

1. Press the **MENU** key to open the menu.
2. Press **▲** or **▼** to select [OS/Barge Mark], then press the **ENTER** key.

Menu	OS/Barge Mark
Brill/Color	OS Mark : Off
Display	Barge Mark : Off
Echo	Barge Length : 0ft
Custom 1	Barge Beam : 0ft
Custom 2	Barge Arrangement
Custom 3	
Alert Settings	
Trails	
Tuning/Channel	
Others	
OS/Barge Mark	
Target	[ENTER]: Enter [CANCEL/HL OFF]: Back
TT	[MENU]: Exit
Turn own ship mark on/off	

- Press ▲ or ▼ to select [OS Mark], then press the **ENTER** key.



- Select [On], then press the **ENTER** key.
- Press the **MENU** key to close the menu.
The own ship mark appears on the display, scaled according to the length and width entered at installation.



2.44.2 How to show the barge mark

The length and breadth of the total barge size can be displayed as a simple rectangle on the radar display. Up to five rows of barges and nine barges per row can be shown.

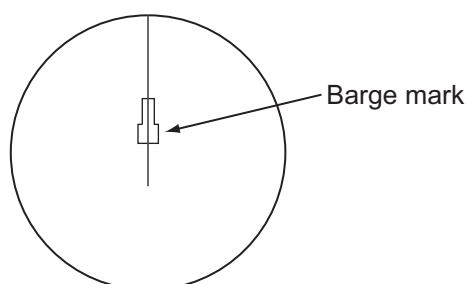

Note: Turn on [OS Mark] in the [OS/Barge Mark] menu to enable display of barge marks.

- Press the **MENU** key to open the menu.
- Press ▲ or ▼ to select [OS/Barge Mark], then press the **ENTER** key.
- Press ▲ or ▼ to select [Barge Mark], then press the **ENTER** key.



- Press ▲ or ▼ to select [On], then press the **ENTER** key.
- Select [Barge Length] then press the **ENTER** key.

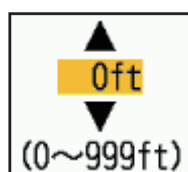

- Set the length of the barge, then press the **ENTER** key.
- Select [Barge Beam] then press the **ENTER** key.
- Set the width of the barge, then press the **ENTER** key.

2. OPERATION

9. Select [Barge Arrangement], then press the **ENTER** key.

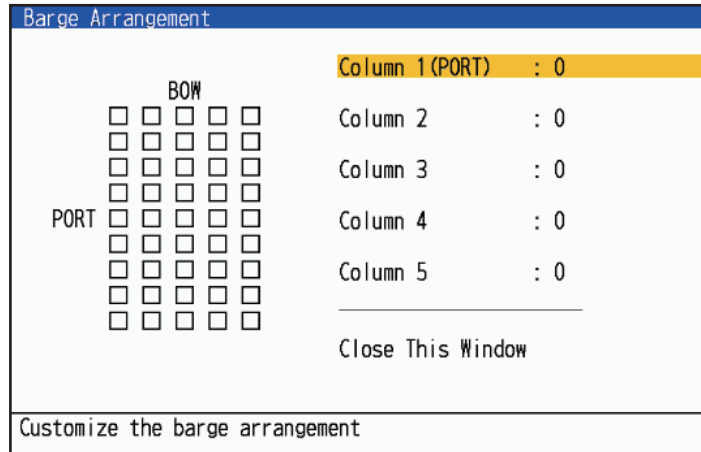

10. [Column1(PORT)] is highlighted by the cursor. Press the **ENTER** key.
 - 1) Set the number of barges in the port column.

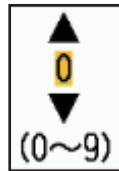

- 2) Set the quantities of barges in the selected column (max: 9), press the **ENTER** key.
The rectangles on the left side of the [Barge Arrangement] window will fill up according to the value you set.
 - 3) After setting all required columns, select [Close This Window], then press the **ENTER** key.
11. Press the **MENU** key to close the menu.

2.45 How to Program Function Keys (F1, F2 and F3 keys)

You can program function keys (F1, F2 and F3) to provide one-touch access to a required function.

2.45.1 Function key operation

To activate a function, press function key, **F1**, **F2** or **F3**. Press same key to change the setting.

In the default arrangement, [F1] key is set to [Gain mode], [F2] key is set to [Sea mode], and [Gain mode], [Sea mode] and [Rain mode] window is displayed (see section 2.10 and section 2.11 for details). [F3] key is set to [Rain Snow Reflection Mode].

2.45.2 How to change a function key program

1. Press the **MENU** key to open the menu.
2. Use ▲ or ▼ to select [Others] and press the **ENTER** key.

3. Use ▲ or ▼ to select [F1 (F2 or F3) Setup] and press the **ENTER** key.
4. Use ▲ or ▼ to select a function from the list and press the **ENTER** key. Below are the available functions.

Rings Brill	Echo Stretch	TCPA
Mark Brill	Echo Average	Proximity
HL Brill	Int Rejector	RV.-Target
Char. Brill (Character Brill)	Display-Dynamic	TT-Display
Trail Brill	Display-Curve	TT-Color
L/L Grid Brill	Target Analyzer	AZ/ALM Select
Chart Brill	T.A. Mode (Target Analyzer Mode)	ACQ by Doppler
Plotter Brill	Rez Boost	TT-Erase Lost
Dep. Line Brill (Depth Line Brill)	Target Alarm 1	AIS-Display
View Position	Target Alarm 2	AIS-Color
Display Color	Watchman	AIS-Erase Lost
Echo Color	Trails-Grad. (Trails - Gradation)	AIS-Ship Name
Back. Color (Background Color)	Trails-Color	AIS-Custom-Std.
Char. Color (Character Color)	Trails-Ref. (Trails Reference)	AIS-Custom-Red
Transparency	Trails-Level	AIS-Custom-Yel.
Echo Col. Mode (Echo Color Mode)	Trails-OwnShip	AIS-Custom-Cyan
Display Mode	WPT Mark	AIS-Custom-Mag. (Magenta)
Zoom	EBL Reference	AIS-Fish. Col. (Fish School Color)
Off-center Mode	VRM Unit	RC-Display
Echo Area	Cursor Data	RC-Color
Data Box	PI Lines	Disp. Chart
Gain Mode	PI Line Mode	Emphasize Land
Sea Mode	Cursor Type	Chart Type
Auto Sea	OS Mark	L/L Grid
Rain Mode	Barge Mark	Disp. Scroll
Auto Rain	Vector Ref.	Disp. Ext Marks
A/C Auto	CPA	Screen Shot
Pulse Width		

5. Press the **MENU** key to close the menu.

Unavailable function on the function keys ([F1], [F2] or [F3])

Below functions are not available when sub display (independent) is connected to the antenna unit.

- [Echo]/[Custom 1/2/3]: [Pulse width], [Risk Visualizer Mode], and [T.A. Mode].
- [Alert]: [Watchman].
- [TT]: [AZ/ALM Select], [ACQ by Doppler].

Screenshot

Insert a USB memory into the slot in the lower left corner of the unit before using the function. Press the function key with [Screenshot] registered to the function key will save the screenshot to the USB memory in PNG format. The working indicator will change to the camera icon when a screenshot is being created. Do not remove the USB memory while the working indicator is the camera icon.

2.46 Initial Sub Menu

The [Initial] sub menu in the [System] menu contains items that allow you to customize your radar to meet your needs.

2.46.1 How to open the Initial sub menu

1. Press the **MENU** key to open the menu.

2. OPERATION

2. Press ▲ or ▼ to select [Initial], then press the **ENTER** key.

Menu	Initial
Radio	Key Beep : Off
Chart	Compass Type : True
▼ System	Range Preset
Initial	NMEA Port 1 : 38400bps
Files	NMEA Port 2 : 38400bps
Tests	NMEA Port 3 : 38400bps
Sector Blanks	NMEA Mixing Out : Off
Units	Mouse Assignment : Target
TT Advanced	Mouse Speed : 3
SCX-20	Cursorpad Speed : 3
SCX-21	
Installation	[ENTER]: Enter [CANCEL/HL OFF]: Back
Factory	[MENU]: Exit
Turn the key beep on/off	

2.46.2 Description of Initial sub menu

[Key Beep]: When a key is pressed, a beep sounds. You can turn on or off this beep.

[Compass Type]: Select the type of bearing sensor connected to the radar; [True] (gyrocompass, satellite compass) or [Magnetic] (magnetic compass).

[Range Preset]: You can select the radar ranges to use. Select a range, then press the **ENTER** key to switch on or off. At least two ranges must be turned on. The maximum range available depends on the radar model.

[NMEA Port 1]: Set the baud rate of the equipment connected to Port 1 ([Auto], [4800], or [38400] (bps)). [Auto] provides automatic detection of baud rate from 4800, 9600, 19200 or 38400 (bps).

[NMEA Port 2]: Same function as Port 1 but for Port 2.

[NMEA Port 3]: Same function as Port 1 but for Port 3.

Note 1: For initial settings of the SCX-21, connect the SCX-21 to NMEA Port 1 in order to reflect the rules when the FR-10/12 and SCX-21 are connected.

Note 2: FR-10/12 does not use software to forcibly switch the communication speed when the SCX-21 is connected. When connecting the SCX-21, set the communication speed to 38400bps.

[NMEA Mixing Out]: Data input to Port 1 may be output from Port 2 mixed with data output to Port 2. Select [On] to use this feature.

[Mouse Assignment]: Select the operating mode for the button of a USB mouse, ([Range] or [Target]). See the table shown below for function in each setting.

[Mouse Assignment] setting

Mode/Function	[Range] setting	[Target] setting
Range	Regardless of the cursor position, left-click to decrease the range, and right-click to increase it. Continuous range change by pressing and holding left button. Right button is inoperative.	Left-click on the RANGE icon to decrease the range, and right-click to increase it. Continuous range change by pressing and holding left button. Right button is inoperative.
TX/STBY	Left-click on the TX/STBY icon to switch between transmitting (TX) and Stand-by (STBY).	
OFF Center	Left-click on the OFF CENTER icon to switch between off and custom.	
TT	No function.	<ul style="list-style-type: none"> • Left-click on the target symbol to acquire the target, and right-click to release the target. • Left-click on the target symbol to select the target, and right-click to release the target.
AIS	No function.	<ul style="list-style-type: none"> • Left-click on the target symbol to activate the target, and right-click to deactivate the target. • Left-click on the target symbol to select the target, and right-click to deselect the target.
Other vessels	No function.	Left-click on the target symbol to select the target, and right-click to deselect the target.
ALARM ACK	Left-click or right-click to acknowledge an alarm when an alarm pop-up appears.	

[Mouse Speed]: Select the speed ([1] to [5]) at which the mouse pointer of a USB mouse moves. The higher the setting, the faster the movement.

[Cursorpad Speed]: Select the speed ([1] to [5]) at which the cursor moves with cursorpad operation. The higher the setting, the faster the movement.

2.47 Sector Blank

You must prevent the transmission in some areas to protect passengers and crew from microwave radiation. Also, if the reflections of echoes from the mast appear on the screen, you must prevent the transmission in that area. You can set two sectors.

2. OPERATION

1. Press the **MENU** key to open the menu.
2. Press ▲ or ▼ to select [Sector Blanks], then press the **ENTER** key.
3. Press ▲ or ▼ to select [Sect-Blank 1 (or 2) Status], then press the **ENTER** key.
4. Press ▲ or ▼ to select [On], then press the **ENTER** key.
5. Press ▲ or ▼ to select [Sect-Blank 1 (or 2) Start], then press the **ENTER** key.

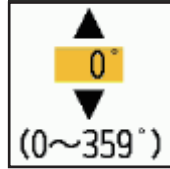

6. Set the start point of the sector, then press the **ENTER** key.
7. Press ▲ or ▼ to select [Sect-Blank 1 (or 2) End], then press the **ENTER** key.

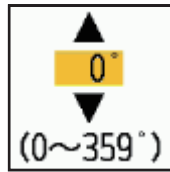

8. Set the end point of the sector, then press the **ENTER** key.
Note 1: You can not set the sector more than 180 degrees.
Note 2: You can not set the total width of sector 1 and sector 2 more than 270 degrees.
9. Press the **MENU** key to close the menu.

As shown in the following illustration, dashed lines mark the start and end points of the sector.

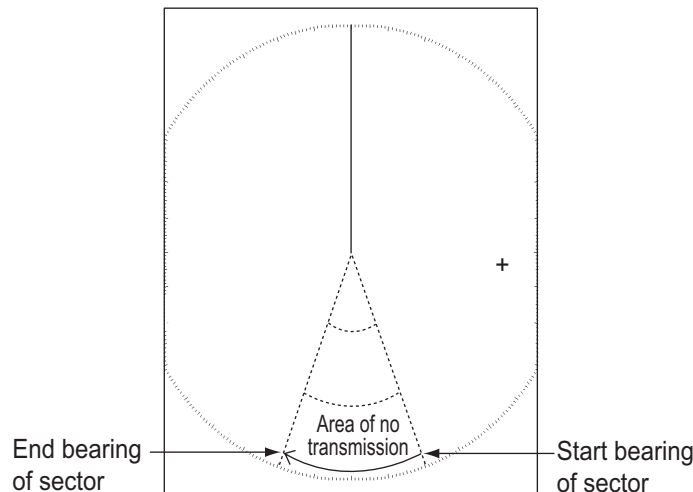

3. HOW TO INTERPRET THE RADAR DISPLAY

3.1 General

3.1.1 Minimum and maximum ranges

Minimum range

The minimum range is defined by the shortest distance at which, using a scale of 0.0625 or 0.125 nm, a target having an echoing area of 10 m² is shown separate from the point representing the antenna position.

The minimum range depends on the pulse length, antenna height, and signal processing (like main bang suppression and digital quantization). Use a shorter range scale as far as it gives favorable definition or clarity of picture.

Maximum range

The maximum detection range, R_{max}, varies depending on the height of the antenna, the height of the target above the sea, the size, shape and material of the target, and the atmospheric conditions.

Under normal atmospheric conditions, the maximum range is equal or a little shorter than the optical horizon. The radar horizon is longer than the optical one by approximately 6% because of the diffraction property of the radar signal. The R_{max} is shown in the following formula.

$$R_{\max} = 2.2 \times (\sqrt{h_1} + \sqrt{h_2})$$

where R_{max}: radar horizon (nautical miles)

h₁: antenna height (m)

h₂: target height (m)

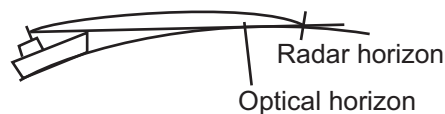

If the height of the antenna is 9 m and the height of the target is 16 m, the maximum radar range is;

$$R_{\max} = 2.2 \times (\sqrt{9} + \sqrt{16}) = 2.2 \times (3 + 4) = 15.4 \text{ nm}$$

Note: The detection range is reduced by precipitation (which absorbs the radar signal).

3.1.2 Radar resolution

The bearing resolution and range resolution are important in radar resolution.

Bearing resolution

The bearing resolution is the ability of the radar to display the echoes received from two targets at the same range as the separate echoes. The bearing resolution is proportional to the antenna length and the wavelength.

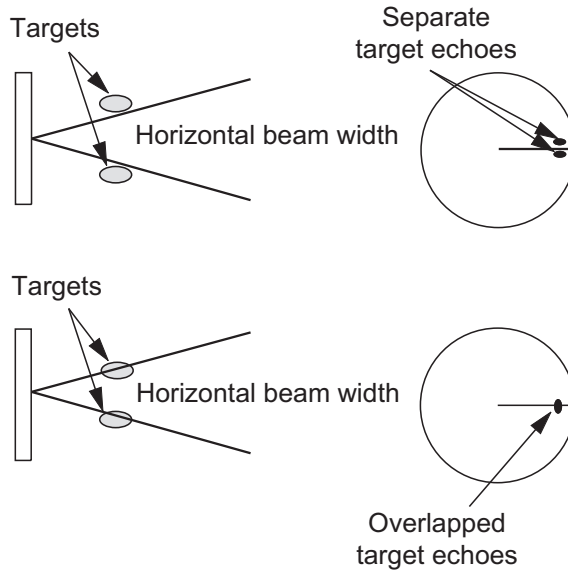

Range resolution

The range resolution is the ability to display the echoes received from two targets on the same bearing as separate echoes. The range resolution is determined by only pulse length.

The test targets used to determine the range and bearing resolution are radar reflectors that have an echoing area of 10 m².

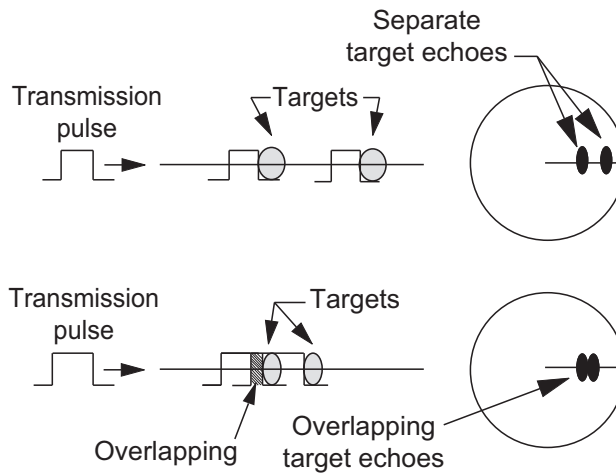

3.1.3 Bearing accuracy

One of the most important features of the radar is how accurately the bearing of a target can be measured. The accuracy of bearing measurement depends on the narrowness of the radar beam. The bearing is taken relative to the heading of the ship. Correct adjustment of the heading line at installation is important to get accurate bearings. To minimize the error when you measure the bearing of a target, put the target echo at the extreme position on the screen by selecting a suitable range.

3.1.4 Range measurement

Measurement of the range to a target is important function of the radar. There are three methods of measuring range: the fixed range rings, the Variable Range Marker (VRM), and the cursor (if set to measure range and bearing). The fixed range rings appear on the screen with a given interval and provide a rough estimate of the range to a target. The diameter of VRM is increased or decreased so that the marker touches the inner edge of the target. The VRM is a more accurate range measurement than the fixed range rings.

3.2 False Echoes

The echo signals can appear on the screen at positions where there is no target or disappear when there are targets. These false echoes are shown below.

3.2.1 Multiple echoes

Multiple echoes occur when a transmitted pulse returns from a solid object like a large ship, bridge, or breakwater. A second, a third or more echoes can be seen on the display at double, triple or other multiples of the actual range of the target as shown below. You can reduce and remove the multiple reflection echoes with the sea clutter function.

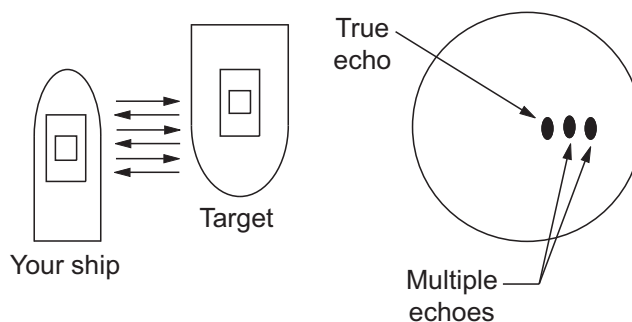

3.2.2 Sidelobe echoes

When the radar pulse is transmitted, some radiation escapes on each side of the beam, called "sidelobes". If a target is where a target can be detected by the sidelobes as well as the mainlobe, the side echoes can be shown on both sides of the true echo at the same range. Sidelobes show normally only on short ranges and from strong targets. You can reduce the sidelobes with the sea clutter function.

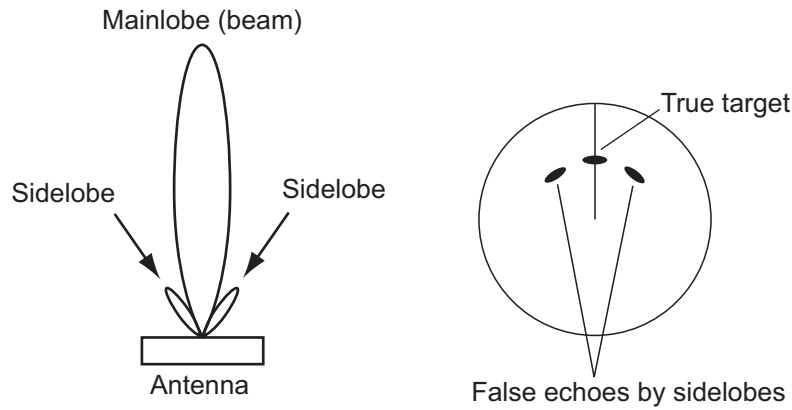

3.2.3 Virtual image

A large target close your ship can appear at two positions on the screen. One of them is the true echo reflected by the target. The other is a false echo which is caused by the mirror effect of a large object on or close your ship as shown in the following figure. If your ship comes close to a large metal bridge, for example, a false echo can temporarily appear on the screen.

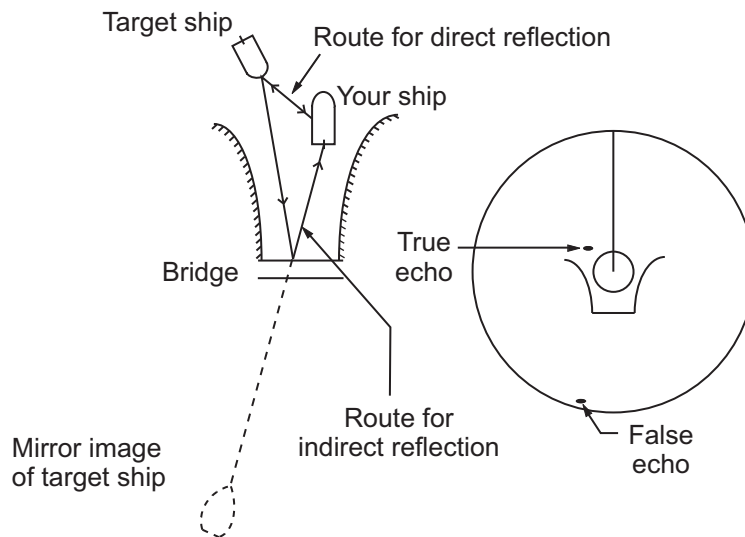

3.2.4 Shadow sector

Funnels, stacks, masts, or derricks near the antenna interrupt the radar beam, and a non-detecting sector can occur. Targets can not be detected within this sector.

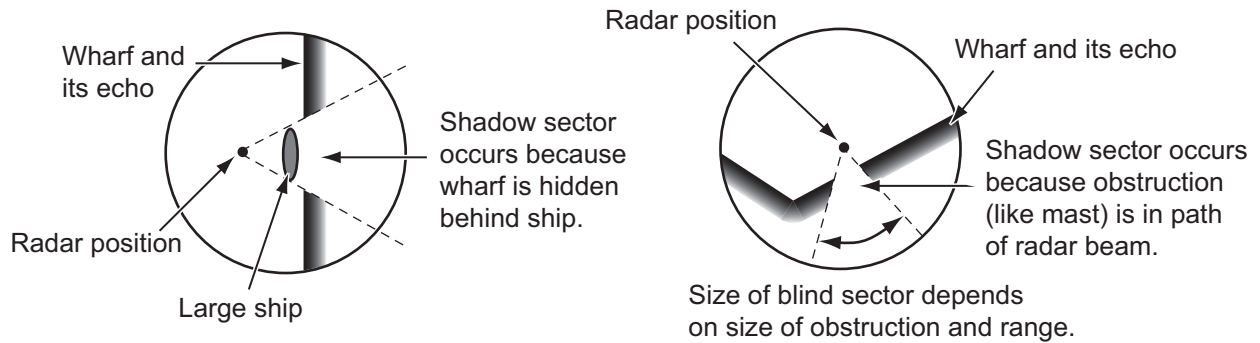

3.3 SART (Search and Rescue Transponder)

3.3.1 SART description

When any X-band radar reaches within a range of approximately 8 nm, a Search and Rescue Transponder (SART) sends a response to the radar signal. The transmitter signal of response is 12-sweeps signal between 9,500 MHz to 9,200 MHz. The time of slow sweep signal is 7.5 μ s and the time of fast sweep signal is 0.4 μ s. When the radar receives this SART signal, a line of 12 dots appears. When the position of SART is distant, the radar display shows only slow sweep signals like the illustration of screen A.

When the radar reaches the SART within approximately 1 nm, the radar display can also show the 12 responses of fast sweep signals like the illustration of screen B. The position of the SART is the closest position of the radar echoes.

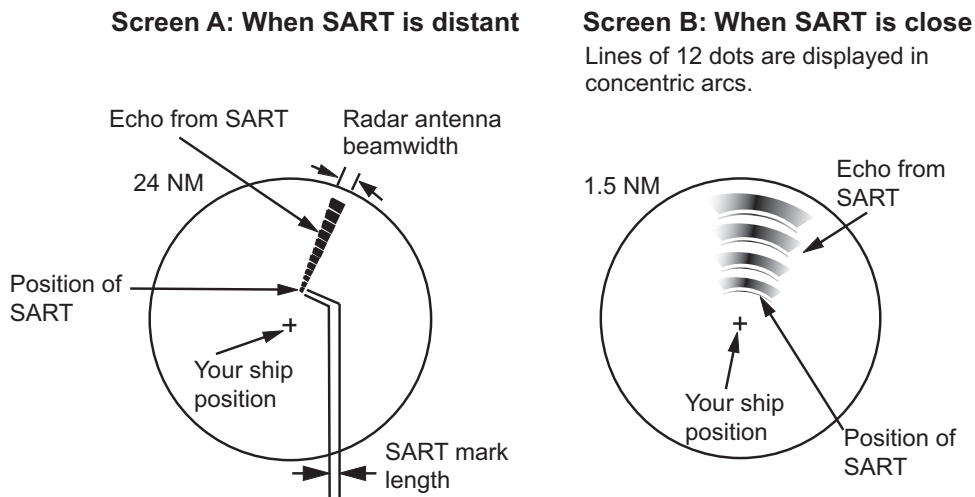

3.3.2 General remarks on receiving SART

SART range errors

When the SART is at a range greater than approximately 1 nm, the first dot is displayed at 0.64 nm beyond the true position of the SART. When the range closes so that the fast sweep responses are seen also, the first range echoes are displayed at 150 m beyond the true position.

Range scale

When you find the SART position, do as follows:

1. Use the **RANGE** key to set the range scale to 6 nm or 12 nm.
2. Turn off [Int Rejector].

SART display

To display only the SART echo clearly on the radar screen, reduce the tuning on manual mode. The normal radar echoes get weak, however, the SART echoes remain. Your ship comes close to the SART, the arc for the SART display becomes larger. Most of the radar screen becomes fuzzy. Adjust the sea clutter and gain to display the necessary screen.

3.4 RACON

A RACON is a radar beacon which emits radar-receivable signals in the radar frequency spectrum (X- or S-band). There are several signal formats; in general, the RACON signal appears on the radar screen as a rectangular echo originating at a point just beyond the position of the radar beacon. It has a Morse coded pattern. Note that the position on the radar display is not accurate.



Echoes on the radar screen

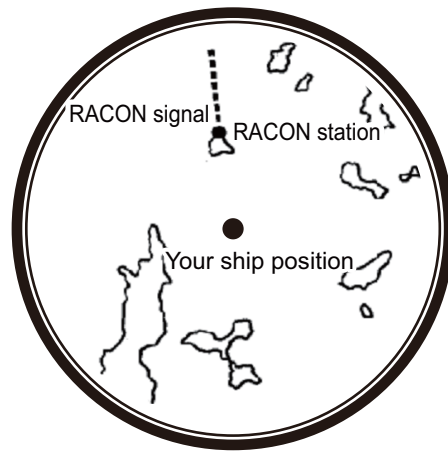

Echo description

4. TT OPERATION

The TT (Target Tracking) feature manually or automatically acquires and tracks (The maximum number of targets depend on the radar sensor). Once a target is acquired, a target is automatically tracked. The target tracking range varies depending on your antenna unit. Heading, positioning and ship's speed information are required to use this function.

4.1 Precautions

WARNING

Do not depend on one navigation device for the navigation of the ship. The navigator must check all aids available to confirm position. Electronic aids are not a replacement for basic navigation principles and common sense.

- The TT automatically tracks an automatically or manually acquired radar target and calculates its course and speed, indicating them by a vector. Since the data from the auto plotter depend on the selected radar targets, the radar must be optimally tuned for use with the auto plotter, to ensure required targets will not be lost or unnecessary targets like sea returns and noise will not be acquired and tracked.
- A target is not always a landmass, reef, ship, but can be returns from the sea surface and clutter. As the level of clutter changes with the environment, the operator must correctly adjust the rain clutter, sea clutter and gain controls so that the target echoes do not disappear from the radar screen.

CAUTION

The plotting accuracy and response of this TT meets IMO standards. The tracking accuracy is affected by the following:

- The tracking accuracy is affected by course change. One to two minutes is required to restore vectors to full accuracy after a sudden course change. (The actual amount depends on gyrocompass specifications.)
- The amount of tracking delay is inversely proportional to the relative speed of the target. Delay is on the order of 15-30 seconds for high relative speed; 30-60 seconds for low relative speed.

The display accuracy is affected by the following:

- Echo intensity
- Pulse width of radar transmission
- Radar bearing error
- Gyrocompass error
- Course change (your ship or target)

4.2 Controls when Using TT Function

ENTER key: Acquire cursor-selected target. Display data for tracked target (in the data box at the bottom of the screen).

CANCEL/HL OFF key: Remove data of cursor-selected tracked target from the data box. Stop tracking the cursor-selected target (when its data is not displayed in the databox).

MENU key: Access the [TT] and [Target] menus.

4. TT OPERATION

Cursorpad: Select a target to acquire (or cancel the tracking). Select a target to show (or remove) target data (controllable with USB mouse also).

4.3 TT Display On/Off

You can turn the TT display on or off. The system continuously tracks TT regardless of this setting.

Note: HDG data is required to use this menu (When HDG is not input, this menu is unavailable).





1. Press the **MENU** key to open the menu.
2. Select [TT], then press the **ENTER** key.
3. Select [Display], then press the **ENTER** key.



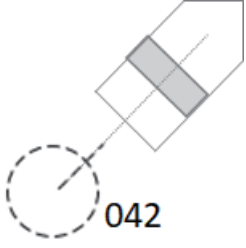

4. Select [Off] or [On], then press the **ENTER** key.
5. Press the **MENU** key to close the menu.

4.4 TT Symbols

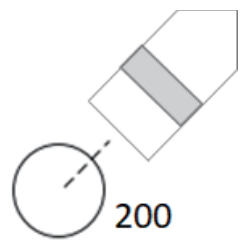
When the TT display is turned on, TT targets are displayed with TT symbols as shown below.

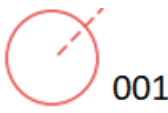
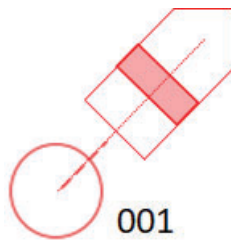
Target type	Symbol	Description	Risk Visualizer™ example
Start tracking		Shortly after acquisition (Common to Manual /Automatic).	-
One minute after acquisition		One minute after acquisition.	
Three minutes after acquisition		Three minutes after acquisition.	

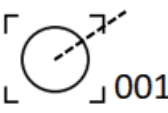
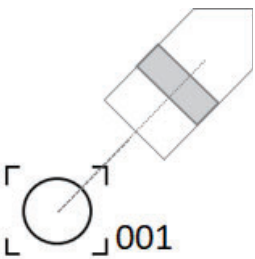
Target type	Symbol	Description	Risk Visualizer™ example
Dangerous target	 001	Dangerous target (flashing)	
Lost target	 001	Lost target	Not available.
Selected target	 001	Selected target (with frame)	

4.5 TT Symbol Color

You can select the TT symbol color from Green, Red, Blue, White or Black.

1. Press the **MENU** key to open the menu.
2. Select [TT], then press the **ENTER** key.
3. Select [Color], then press the **ENTER** key.
Below window appears to select the symbol color.

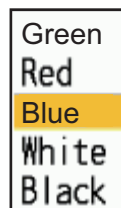

4. Select the color (Green, Red, Blue, White or Black), then press the **ENTER** key.
5. Press the **MENU** key to close the menu.

4.6 How to Acquire and Track Targets

Targets can be acquired and tracked manually or automatically.

The maximum number of acquirable targets varies depending on the antenna and other factors (either manually or automatically). Use the following table for reference.

Note: Heading data is required when you use this menu and TT function.

Antenna model	Single stand-alone configurations		Dual stand-alone configurations* ¹	
	DRS4D/6A/12A/ 25A X-Class	With AZ off	100 manual, no auto-acquire.	With AZ off
With AZ on		50 manual, 50 auto-acquire.	With AZ on	50 manual 50 auto-acquire (Main display only). 100 manual (Sub display only).
DRS2D/4D/6A/ 12A/25A-NXT	With AZ and Doppler off	30 manual, no auto-acquire.	With AZ and Doppler off	30 manual; no auto-acquire (Main display only). 100 manual; no auto-acquire (Sub display only).
	With AZ on, Doppler off	30 manual, 30 auto by AZ, 0 by Doppler	With AZ on, Doppler off	30 manual, 30 auto by AZ (Main display only). 100 manual (Sub display only).
	With AZ off, Doppler on	30 manual, 0 auto by AZ, 40 by Doppler.	With AZ off, Doppler on	30 manual, 40 auto by AZ (Main display only). 100 manual (Sub display only).
	With AZ on, Doppler on	30 manual, 30 auto by AZ, 40 by Doppler	With AZ on, Doppler on	30 manual, 30 auto by AZ 40 manual by doppler. 100 manual (Sub display only) Main display only).
DRS4DL+	With AZ off	30 manual, no auto-acquire.	Not available	
	With AZ on	15 manual, 15 auto-acquire.		

*¹: Display units must set as [Independent] at installation and must also be on the same network.

4.6.1 Manual acquisition

To manually acquire a target, do the following:

1. Use the cursorpad or USB mouse to put the cursor on the target to acquire.
2. Press the **ENTER** key.

The TT symbol changes over time as shown in the figure at top of the next page. A vector, which indicates the motion direction of the target, appears shortly after acquisition.

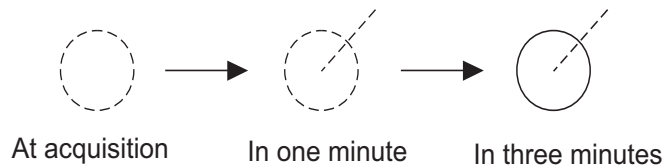

Target number

A maximum of ten targets can be acquired and tracked. When a target is lost and a new target is acquired and tracked, it is assigned the youngest empty target number.

4.6.2 Automatic acquisition

The FR-10/12 can provide multiple means of automatic acquisition, depending on the radar sensor connected.

How to set the Automatic Acquire Zone (AZ)

This function is available regardless of which radar sensor is connected. Set the auto acquire zone, and TT's entering the area will be automatically acquired. See section 2.32.1 for details on setting up the automatic acquisition area.

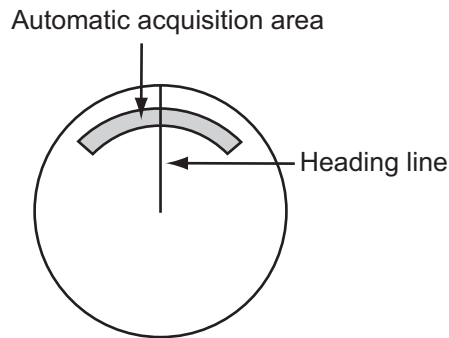

1. Press the **MENU** key to open the menu.
2. Select [TT], then press the **ENTER** key.
3. Select [AZ/ALM Select], then press the **ENTER** key.
4. Select [ACQ Zone], then press the **ENTER** key.
5. Press the **MENU** key to close the menu.

How to set the Automatic TT acquisition by Doppler

This function is available only for the DRS-NXT series radar sensor. The automatic acquisition area can be set without setting TT.

1. Press the **MENU** key to open the menu.
2. Select [TT], then press the **ENTER** key.
3. Select [ACQ by Doppler], then press the **ENTER** key.



4. Press [On] to activate.
5. Press the **MENU** key to close the menu.

4.7 How to Stop Tracking a TT

When the maximum number of targets have been acquired, no more acquisition occurs unless targets are canceled. If you need to acquire other targets, you must cancel one or more targets individually, or all targets at once time from menu. Use one of the following procedures.

4.7.1 How to stop tracking a single target

1. Use the cursorpad or USB mouse to put the cursor on the target to cancel the tracking.
2. Press the **CANCEL/HL OFF** key to cancel the tracking and erase the TT symbol. The unit beeps and the symbol is erased from the screen.

4.7.2 How to stop tracking all targets

1. Press the **MENU** key to open the menu.
2. Select [TT], then press the **ENTER** key.
3. Select [TT Erase], then press the **ENTER** key. A confirmation message appears.
4. Use the cursorpad to select [Yes], then press the **ENTER** key. All symbols are erased from the screen and the long beep sounds.
5. Press the **MENU** key to close the menu.

4.8 Lost Target

When the system detects a lost TT, the audio alarm sounds and the alarm message "LOST" appears. The target symbol becomes a flashing circle like the image to the right. When the system detects the target again, the target symbol becomes a normal symbol.

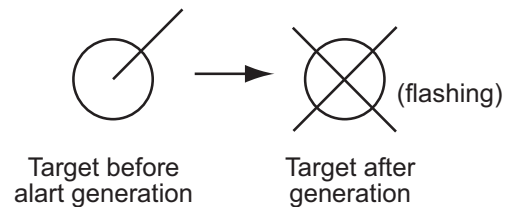

How to activate, deactivate the lost target alert

Follow the procedure shown below to activate or deactivate the lost target alert. The setting is shared with AIS.

1. Press the **MENU** key to open the menu.
2. Select [Target], then press the **ENTER** key.
3. Select [Lost Alert], then press the **ENTER** key. A confirmation message appears.
4. Use the cursorpad to select [On] or [Off], then press the **ENTER** key. [Off] disables the lost target alert.
5. Press the **MENU** key to close the menu.

How to erase the lost TT symbol

To manually erase a lost TT symbol, put the cursor on the symbol, then press the **CANCEL/HL OFF** key. The lost target symbol is automatically erased one minute after a TT becomes lost.

How to stop tracking all lost targets

You can stop tracking all lost targets.

1. Press the **MENU** key to open the menu.
2. Select [Target], then press the **ENTER** key.
3. Select [TT Erase], then press the **ENTER** key. A confirmation message appears.
4. Use the cursorpad (**▲**) to select [Yes], then press the **ENTER** key.
5. Press the **MENU** key to close the menu.

4.9 Vector Attributes

4.9.1 What is a vector?

A vector is a line extending from a tracked target. A vector shows speed and course of the target. The top of a vector shows estimated position of the target after the selected vector time elapses. If you extend the vector length (time), you can evaluate the risk of collision with any target.

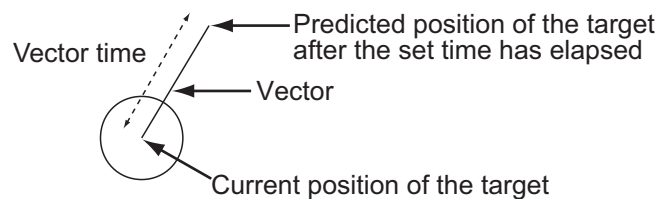

4.9.2 Vector time and vector reference

1. Press the **MENU** key to open the menu.
2. Select [Target], then press the **ENTER** key.

Menu	Target
Tuning/Channel	Vector Time : 6min
Others	Vector Time Link : No Link
OS/Barge Mark	Vector Reference : True
Target	Own Ship Vector : 0n
TT	Past Positions : 5
AIS	Past Posn Interval : 1min
Radio	CPA : Off
Chart	TCPA : 1min
► System	Proximity : Off
	Lost Alert : Off
	Risk Visualizer
	[ENTER]: Enter [CANCEL/HL OFF]: Back
	[MENU]: Exit
Set target vector time	

3. Select [Vector Time], then press the **ENTER** key.
4. Select time, then press the **ENTER** key.
5. Select [Vector Reference], then press the **ENTER** key.

4. TT OPERATION

6. Select [Relative] or [True] then press the **ENTER** key.

[Relative]: Other ships' vectors are displayed relative to your ship. This mode helps find targets on a collision course. If a ship is on a collision course with your ship, the vector of a ship points toward your ship position.

[True]: Your ship's and other ships' vectors are displayed at their true motions. This mode helps discriminate between moving and stationary targets.

Note: Heading data and own ship speed data are required for setting [True].

7. Press the **MENU** key to close the menu.

Note: The functions of the [Target] menu are shared by TT and AIS.

4.9.3 Vector time link

The vector time link feature sets how to determine vector length when the range is changed.

1. Press the **MENU** key to open the menu.
2. Select [Target], then press the **ENTER** key.
3. Select [Vector Time Link], then press the **ENTER** key.
4. Select [Range Link] or [No Link], then press the **ENTER** key.

[Range Link]: Vector time is automatically adjusted so that the length of vectors remains constant when the range is changed. Vector time is shown in yellow at the bottom-center of the screen.

[No Link]: Vector length changes proportionally with newly selected range..

5. Press the **MENU** key to close the menu.

4.9.4 Own ship vector

The vector of own ship is shown as an arrow from your ship position. The vector of own ship is shown on the following conditions:

- Select [True] on the menu item [Vector Reference] on the [Target] menu.
- Select [On] on the menu item [Own Ship Vector] on the [Target] menu.

Note 1: The vector of own ship is shown in the same color as the TT symbol color.

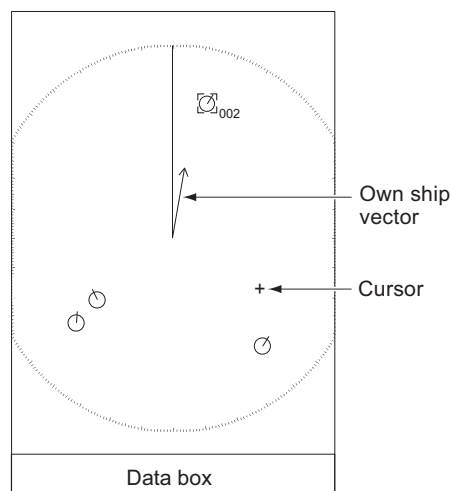

Note 2: Heading data and own ship speed data are required to set [Vector Reference].

1. Press the **MENU** key to open the menu.

2. Select [Target], then press the **ENTER** key.
3. Select [Own Ship Vector], then press the **ENTER** key.
4. Select [On], then press the **ENTER** key.
Own ship vector is displayed with arrow. Disappears when selects [Off].
5. Press the **MENU** key to close the menu.

4.10 Past Position Display (target past position)

This radar can display time-spaced dots (maximum ten dots) that mark the past positions of any TT. You can evaluate actions of a target by the spacing between dots. Below are examples of dot spacing and target movement.

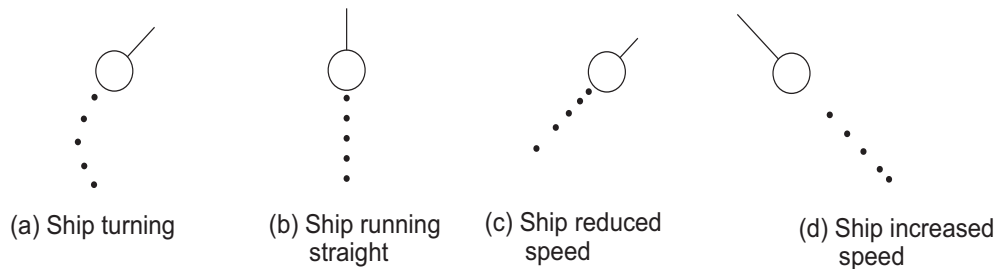

You can select the number of past position dots to display and the time interval to display the dots.

1. Press the **MENU** key to open the menu.
2. Select [Target], then press the **ENTER** key.
3. Select [Past Positions], then press the **ENTER** key.



4. Select number of past position dots to display (5 or 10) or select [Off] to turn off the past positions display.
5. Press the **ENTER** key.
6. Select [Past Posn Interval], then press the **ENTER** key.

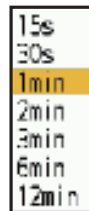

7. Select the time interval, then press the **ENTER** key.
8. Press the **MENU** key to close the menu.

4.11 TT Data

You can show TT data at the bottom of the screen. Press ▲ or ▼ to select [Display]-[Data Box], then press the [Target] (TT data) or [All] (TT data + nav data).

1. Use the cursorpad or USB mouse to put the cursor on an TT.
2. Press the **ENTER** key to show the data of the target.

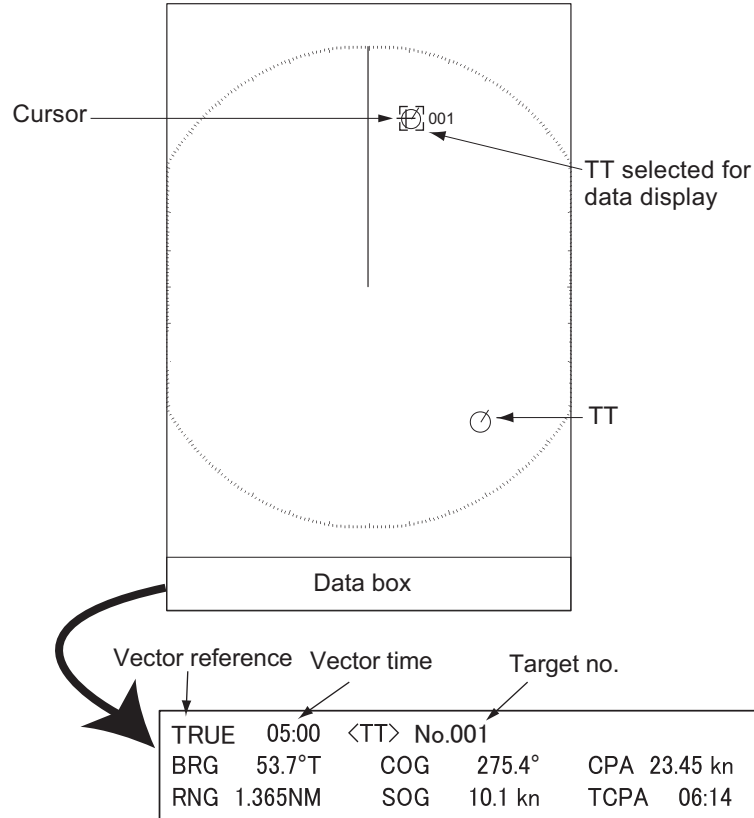

The symbol for the selected TT is displayed at two-times normal size.

To remove the data of a target from a data box, put the cursor on the corresponding target symbol, then press the **CANCEL HL OFF** key or USB mouse.

4.12 CPA/TCPA Alarm

Set CPA (Closest Point of Approach) alarm range and TCPA (predicted Time to CPA) alarm time to alert you when targets are on a collision course. When CPA and TCPA of any TT become less than the preset CPA and TCPA alarm settings, the audio alarm sounds. The alarm message "COLLISION" appears. The target symbol changes to a dangerous target symbol (triangle) and flashes with its vector. You can stop the audio alarm with any key.

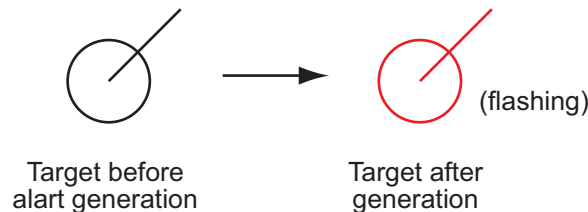

This feature helps identify targets which are on a collision course. Correctly adjust the gain, sea clutter and rain clutter.

	<h1>CAUTION</h1>
<p>Do not depend on the CPA/TCPA alarm as the only method to detect the risk of collision. The navigator is not released of the responsibility to keep visual caution for collision situations, whether or not the radar or other plotting aid is in use.</p>	

1. Press the **MENU** key to open the menu.
2. Select [Target], then press the **ENTER** key.
3. Select [CPA], then press the **ENTER** key.

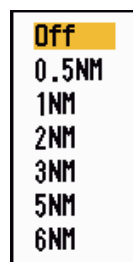

4. Set the CPA distance, then press the **ENTER** key.
5. Select [TCPA], then press the **ENTER** key.



6. Set the TCPA time, then press the **ENTER** key.
7. Press the **MENU** key to close the menu.

4.13 Proximity Alarm

The proximity alarm alerts you when a TT is within the range you set (The setting is commonly shared between TT and AIS. See section 5.12.). The audio alarm sounds and the alarm message "PROXIMITY" appears. The target symbol changes to a dangerous target symbol and flashes with its vector. Press any key to stop the audio alarm. The flashing continues until the target is not within the range set, the alarm range is changed to exclude the target, or the proximity alarm is deactivated.



1. Press the **MENU** key to open the menu.
2. Select [Target], then press the **ENTER** key.
3. Select [Proximity], then press the **ENTER** key.
4. Set the distance for the proximity alarm, then press the **ENTER** key.
5. Press the **MENU** key to close the menu.

Another TT menus

Menu	Function
Display	Activates/deactivates TT symbol.
Color	Selects the symbol color (Green, Red, Blue, White, Black)
AZ/ALM Select	Switches between Automatic Acquire Zone (AZ) and
ACQ by Doppler	Automatically acquires other vessels within 3 nm.
Erase Lost Targets	Deactivates lost target information.
TT Erase	Deactivates all target information.

4.14 How to Use the Risk Visualizer™ Function

The Risk Visualizer™ shows the "navigation paths/zones" of surrounding vessels and alerts mariners through the use of colors when there is a potential risk of approach or collision between your vessel and a tracked target (TT) or a AIS target. The color of the paths/zones depends on the degree of danger and the possibility of a collision. For details, see <https://www.furuno.com/en/technology/>

When the Risk Visualizer™ is turned on, the collision area of another approaching ship is displayed as shown below. Maneuver your vessel accordingly, to avoid collision.

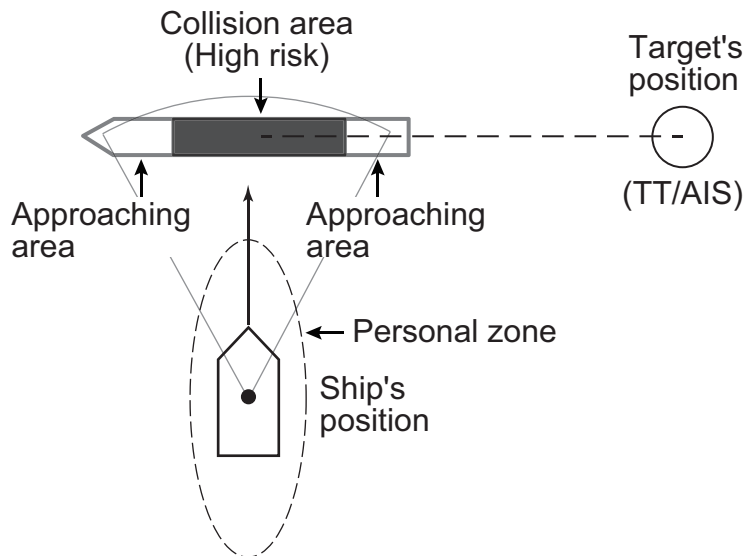



CAUTION



This function is a valuable anti-collision aid. However, in actual operations, follow the International Regulations for the Prevention of Collisions at Sea (IRPCS) and other applicable navigation rules, for safety of vessel and crew.

Basic specifications

- Display up to 20 targets (total of TT + AIS) that have a high risk of collision.

Notices

The following data are required for using each Risk Visualizer™.

Data	TT Risk Visualizer™	AIS Risk Visualizer™
HDG	Required	
SOG	Required	
COG	Required	
Ship's Position	Not required	Required

Change of icon shape in proximity area

The shape of the approach area, indicated by a rectangle with irregularities in the front and back, changes depending on the speed and position between the target and the ship.

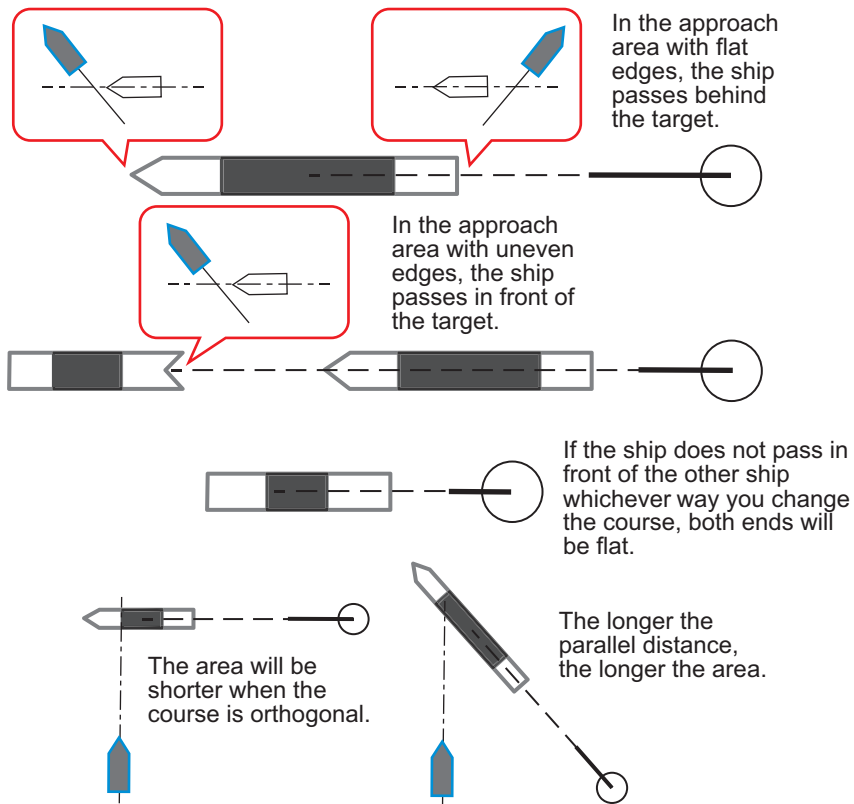

4.14.1 How to set up the Risk Visualizer™ display

1. Press the **MENU** key to open the menu.
2. Press **▲** or **▼** to select [Target], then press the **ENTER** key.

Menu	Target
Brill/Color	Vector Time : 6min
Display	Vector Time Link : No Link
Echo	Vector Reference : True
Custom 1	Own Ship Vector : On
Custom 2	Past Positions : 5
Custom 3	Past Posn Interval : 1min
Alert Settings	CPA : Off
Trails	TCPA : 1min
Tuning/Channel	Proximity : Off
Others	Lost Alert : Off
OS/Barge Mark	Risk Visualizer
Target	[ENTER]: Enter [CANCEL/HL OFF]: Back
TT	[MENU]: Exit

Set display conditions for the zone having a risk of target collision

3. Press ▲ or ▼ to select [Risk Visualizer], then press the **ENTER** key.
The [Risk Visualizer] settings window appears (The values shown in below are factory default).

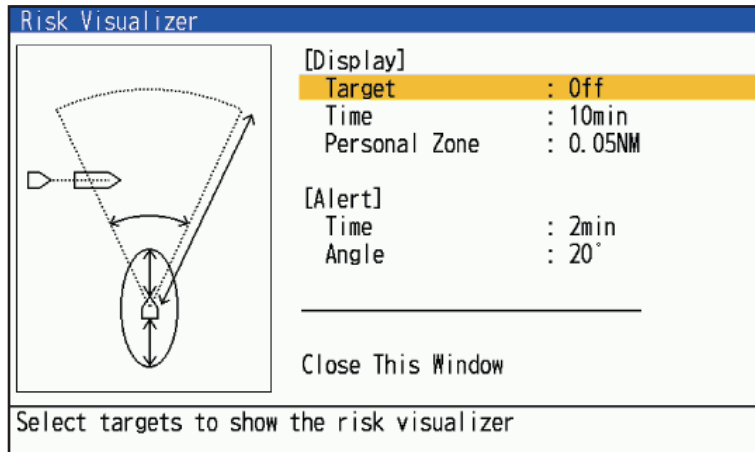

4. Press ▲ or ▼ to select [Display] - [Target], then press the **ENTER** key.



5. Press ▲ or ▼ to select which targets to apply the Risk Visualizer™ function to.
Then press the **ENTER** key.
- [Off]: Disables the function.
 - [TT]: Only shows TT targets for risk visualization.
 - [AIS]: Only shows AIS targets for risk visualization.
 - [TT+AIS]: Shows both TT and AIS targets for risk visualization.
6. Press ▲ or ▼ to select [Display] - [Time], then press the **ENTER** key.



7. Press ▲ or ▼ to select the required time, then press the **ENTER** key.
Only the approaching/collision areas of other vessels are displayed when the estimated time of approach/collision is within the time set here.
8. Press ▲ or ▼ to select [Display] - [Personal Zone], then press the **ENTER** key.

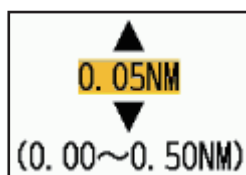

4. TT OPERATION

9. Press ▲ or ▼ to select the required distance, then press the **ENTER** key.
This distance is a fore and aft “buffer” around your vessel. Any targets which enter the bubble are displayed on-screen as potential risks. Risk Visualizer™ calculates the proximity area based on this value.
The smaller the personal zone, the fewer the number of approach/collision areas on the screen.
The larger the personal zone, the longer the approach/collision area.
The smaller the personal zone, the shorter the approach/collision area.
10. Press the **MENU** key to close the menu.

4.14.2 Risk Visualizer™ alerts

The Risk Visualizer™ calculates potential risks based on the time and angle of a vessel in relation to your vessel. When a target violates both settings, an audiovisual alert is released. To set these parameters, do the following:

1. Press the **MENU** key to open the menu.
2. Press ▲ or ▼ to select [Target], then press the **ENTER** key.
3. Press ▲ or ▼ to select [Risk Visualizer], then press the **ENTER** key. The [Risk Visualizer] settings window appears.
4. Press ▲ or ▼ to select [Alert] - [Time], then press the **ENTER** key.
Select the time in the area where the alarm will be triggered. For example, if set to 1 minute, an alarm will be triggered if the approaching area is reached within 1 minute, but no alarm will be triggered if it is farther away. If set to Off, no alarm will be triggered.



5. Press ▲ or ▼ to select the alert time, then press the **ENTER** key.
6. Press ▲ or ▼ to select [Alert] - [Angle], then press the **ENTER** key.
Select the angle of the area where the alarm will be triggered. A smaller angle is less likely to cause an alarm, while a larger angle is more likely to cause an alarm. 360° will cause an alarm when the approaching area is within 360° of the ship's bow (the entire circumference).
7. Press ▲ or ▼ to select the alert angle, then press the **ENTER** key.
8. Press the **MENU** key to close the menu.
Note 1: Risk Visualizer alerts and CPA/TCPA alerts cannot be used simultaneously. When the Risk Visualizer display setting is set to [TT+AIS], CPA/TCPA alarms are disabled when the risk visualizer display setting is set to [TT+AIS]. When the risk visualizer display setting is set to [TT], only CPA/TCPA alarms via AIS are enabled. When set to [AIS], only CPA/TCPA alarms by TT are enabled. When set to [AIS], only CPA/TCPA alarms by TT are enabled.

Note 2: When [Risk Visualizer] is assigned to a function key, each press of that function key toggles the display setting in the order of [Off], [TT], [AIS], and [TT+AIS]. [When using the [TT] setting, pressing the function key three times will set the setting to [Off].

Note 3: When the TT/AIS vector reference is set to [Relative], the target vector and the Risk Visualizer™ icon will appear in different directions. To display them in the same direction, set the TT/AIS vector reference to [true].

4. TT OPERATION

This page is intentionally left blank.

5. AIS OPERATION

Connected to the FURUNO AIS Transponders FA-170, FA-150, FA-100, FA-50, or the AIS Receiver FA-30, the FR-10/FR-12 can show the name, position and other navigation data of the nearest AIS transponder-equipped ships.

This radar accepts position data fixed by WGS-84 geodetic datum. Set the datum to WGS-84 on the GNSS navigator connected to this radar, if this radar is connected to the FURUNO GNSS equipment.

Controls for Use with AIS

ENTER key: (1) Activate the cursor-selected target, (2) Display data for selected active target (in the data box at the bottom of the screen).

CANCEL/HL OFF key: Remove data of cursor-selected AIS target from the data box. Sleep cursor-selected target (when its data is not displayed in the data box). Access the [Target] and [AIS] menu.

Cursorpad/USB mouse: Select a target to activate (or sleep). Select a target to show (or remove) target data.

5.1 AIS Display On/Off

You can turn the AIS display on or off. With the display turned off, the system continues processing AIS targets if the AIS transponder is turned on.

Note: Heading and positioning information are required to use this function

1. Press the **MENU** key to open the menu.
2. Select [AIS], then press the **ENTER** key.

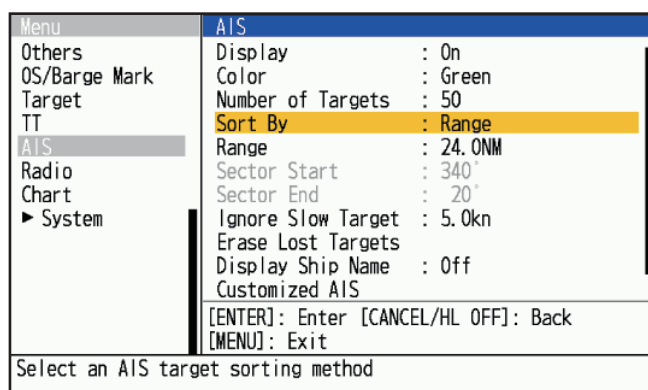









3. Select [Display], then press the **ENTER** key.

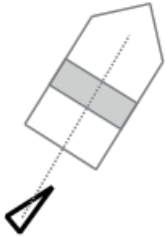

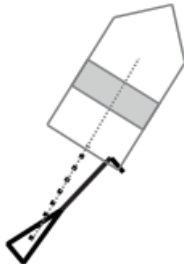

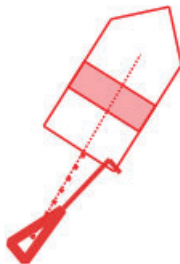

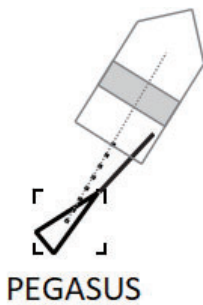
4. Select [Off] or [On] then press the **ENTER** key.
[Off]: All AIS symbols are erased from the screen.
[On]: AIS function is active, and a maximum of 100 target symbols are shown.
5. Press the **MENU** key to close the menu.

5.2 AIS Symbols

When the AIS is turned on, AIS targets are displayed with AIS symbol as below.

Target type	Symbol	Description	Risk Visualizer™ example
Sleeping target		Sleeping target	
Activated target		Activated target. Heading line and ROT are shown. Ground tracking speed and course are shown with vector.	
Dangerous target		The symbol will be activated and flashes red when the conditions for a CPA/TCPA alarm or Risk Visualizer™ alarm are met. The symbol will light in red upon acknowledgement.	
Lost target		A target for which no data has been received within a certain period. The symbol flashes.	Not available.
Selected target		A target selected to show its target data.	
Aid to navigation (AtoN)			Not available.

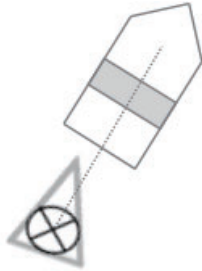
Target type	Symbol	Description	Risk Visualizer™ example
AIS base station		Always shown on the screen.	Not available.
SART aircraft		Always shown on the screen.	Not available.
AIS-SART		Always shown on the screen.	Not available.
AIS Search and Rescue (SAR) Vessel		Symbol for for AIS search and rescue vessel.	

5.3 Activating, Sleeping Targets

When you change a sleeping target to an activated target, a vector shows the course and speed of that target. You can easily judge the target movement by the length and pointing direction of the vector.

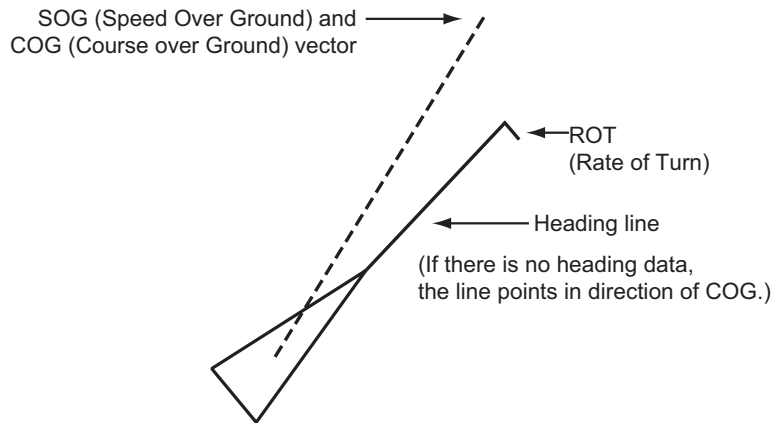

When there are many activated targets on the screen, an activated target may hide radar images or TT. You can sleep an activated target to unhide image or TT.

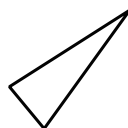

To activate a target: Put the cursor on the target, then press the **ENTER** key or USB mouse.

To sleep a target: Put the cursor on the target, then press the **CANCEL HL OFF** key or USB mouse.

5.4 AIS Target Data

You can show AIS target data at the bottom of the screen. Press ▲ or ▼ to select [Display]-[Data Box], then press [Target] (AIS data) or [All] (AIS data + nav data) position.

1. Use the cursorpad to put the cursor on an activated target.
2. Press the **ENTER** key to show the data of the target.

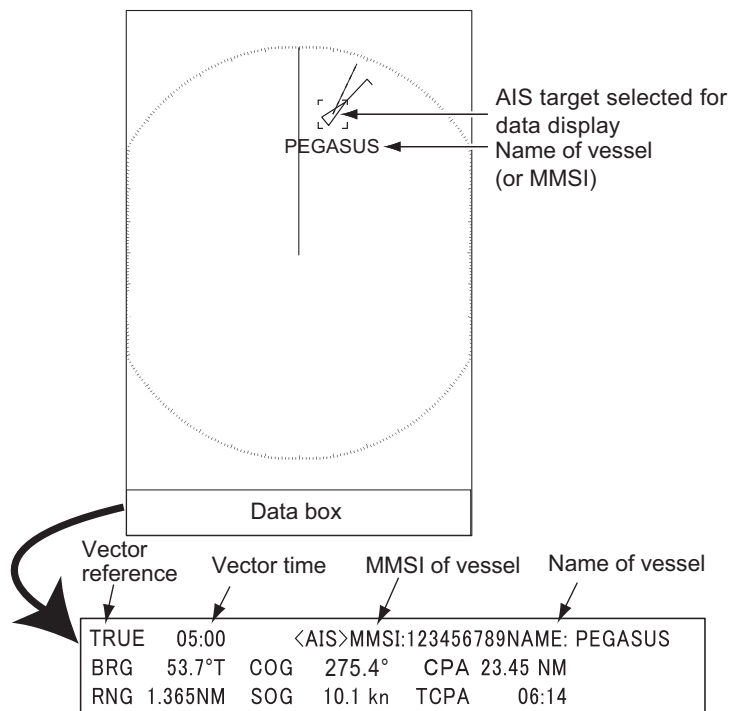

AIS target data

To remove the target data from a data box, put the cursor on the corresponding target symbol, then press the **CANCEL HL OFF** key or USB mouse.

5.5 How to Sort Targets

You can sort the AIS targets received from the AIS transponder by range from your ship, sector, CPA or TCPA.

1. Press the **MENU** key to open the menu.
2. Select [AIS], then press the **ENTER** key.
3. Select [Sort By], then press the **ENTER** key.
4. Select sorting method, then press the **ENTER** key.
 - [Range]: Sort targets within the display range set (see section 5.6), from the nearest to the furthest.
 - [Sector]: Sort targets within the display sector set (see section 5.7) and within 24 nm, from the nearest to the furthest.
 - [CPA]: Sort targets within 24 nm by CPA, from the closest to the furthest.
 - [TCPA]: Sort targets within 24 nm by TCPA, from the earliest time to the latest time.
5. Press the **MENU** key to close the menu.

5.6 Display Range

You can set the AIS system to show only those AIS targets within the range you set. The setting range differs depending on the connected radar sensor. Actual range depends on the AIS Transponder. If the target sorting method is selected to [Range], the target data within the range set here is transmitted to this radar.

1. Press the **MENU** key to open the menu.
2. Select [AIS], then press the **ENTER** key.
3. Select [Range], then press the **ENTER** key.

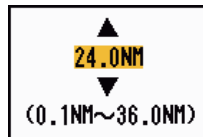

4. Set the display range, then press the **ENTER** key.
5. Press the **MENU** key to close the menu.

Note: The unit of measurement for range is NM.

5.7 How to Display the Targets within a Specific Sector

You can display AIS targets only within a specific sector. If the target sorting method is selected to [Sector], the target data within the sector are shown on the display unit.

1. Press the **MENU** key to open the menu.
2. Select [AIS], then press the **ENTER** key.
3. Select [Sector Start], then press the **ENTER** key.

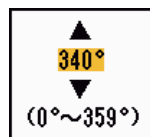

4. Set the start point for the sector, then press the **ENTER** key.
5. Select [Sector End], then press the **ENTER** key.

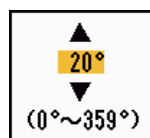

6. Set the end point for the sector, then press the **ENTER** key.
7. Press the **MENU** key to close the menu.

5.8 Number of Targets to Display

You can select the maximum number of AIS targets to display. The setting value is 10 to 100. When the screen becomes cluttered with AIS targets, you can limit the number of AIS targets to show. Targets are selected and displayed according to sort method. (see section 5.5).

1. Press the **MENU** key to open the menu.
2. Select [AIS], then press the **ENTER** key.
3. Select [Number of Targets], then press the **ENTER** key.
4. Select the number of targets to display, then press the **ENTER** key.
5. Press the **MENU** key to close the menu.

5.9 Vector Attributes

5.9.1 What is a vector?

A vector is a line extending from a tracked target. A vector shows speed and course of the target. The top of a vector shows estimated position of the target after the selected vector time elapses. If you extend the vector length (time), you can evaluate the risk of collision with any target.

5.9.2 Vector time and vector reference

1. Press the **MENU** key to open the menu.
2. Select [Target], then press the **ENTER** key.
3. Select [Vector Time], then press the **ENTER** key.
4. Select time, then press the **ENTER** key.
5. Select [Vector Reference], then press the **ENTER** key.
6. Select [Relative] or [True] then press the **ENTER** key.
[Relative]: Other ships' vectors are displayed relative to your ship. This mode helps find targets on a collision course. If a ship is on a collision course with your ship, the vector of a ship points toward your ship position.
[True]: Your ship's and other ships' vectors are displayed at their true motions. This mode helps discriminate between moving and stationary targets.
7. Press the **MENU** key to close the menu.

5.10 Past Position Display (target past position)

This radar can display time-spaced dots (maximum ten dots) that marks the past positions of any tracked AIS target. You can evaluate actions of a target by the spacing between dots. Below are examples of dot spacing and target movement.

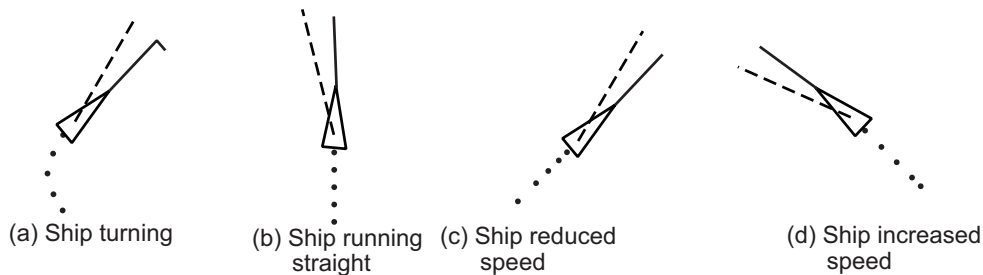

You can select the number of history dots to display and the time interval to display the history dots.

1. Press the **MENU** key to open the menu.
2. Select [Target], then press the **ENTER** key.
3. Select [Past Positions], then press the **ENTER** key.
4. Select number of past position dots to display (5 or 10) or select [Off] to turn off the past position display.
5. Press the **ENTER** key.
6. Select [Past Posn Interval], then press the **ENTER** key.
7. Select time interval, then press the **ENTER** key.
8. Press the **MENU** key to close the menu.

5.11 CPA/TCPA Alarm

Set CPA (Closest Point of Approach) alarm range and TCPA (predicted Time to CPA) alarm time to alert you when targets are on a collision course. When CPA and TCPA of any AIS target (including a sleeping target) become less than the preset CPA and TCPA alarm settings, the audio alarm sounds. The alarm message "COLLISION" appears. The target symbol changes to a dangerous target symbol (red) and flashes with its vector. You can stop the audio alarm and flashing with any key. The dangerous target symbol is displayed until the AIS target is not in the CPA and TCPA alarm setting range. The AIS continuously monitors CPA and TCPA of all AIS targets.

This feature helps identify targets that can be on a collision course.

1. Press the **MENU** key to open the menu.
2. Select [Target], then press the **ENTER** key.
3. Select [CPA], then press the **ENTER** key.
4. Select CPA distance, then press the **ENTER** key.
5. Select [TCPA], then press the **ENTER** key.
6. Select TCPA time, then press the **ENTER** key.
7. Press the **MENU** key to close the menu.

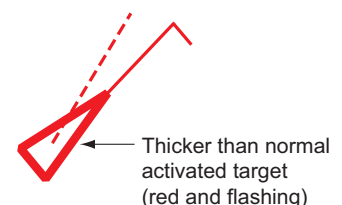

5.12 Proximity Alarm

The proximity alarm alerts you when an AIS target is within the range you set (The setting is commonly shared between TT and AIS. See section 4.13). When a target meets the conditions of the alarm, the audio alarm sounds and the alarm message "PROXIMITY" appears. The target symbol changes to a dangerous target symbol (red) and flashes with its vector. Press any key to stop the audio alarm and flashing. The dangerous target symbol is displayed until the target is not within the range set, the alarm range is changed to exclude the target, or the proximity alarm is deactivated.

1. Press the **MENU** key to open the menu.
2. Select [Target], then press the **ENTER** key.
3. Select [Proximity], then press the **ENTER** key.
4. Select the range, then press the **ENTER** key.
5. Press the **MENU** key to close the menu.

5.13 Lost Target

When AIS data is not received from a target at fixed interval (3 to 5* report intervals), the target symbol changes to the lost target symbol (flashing). No audio or visual alarm is given for a lost target.

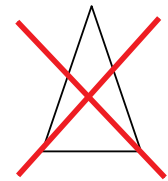

* The interval at which AIS data is sent depends on speed of the AIS transponder. For detailed information, refer to the Operator's Manual for the AIS transponder.

Lost AIS targets are automatically removed from the display one minute after they are determined as lost. You can also remove all lost AIS targets from the display as follows:

Lost target alarm on/off

Set on/off the lost target alert. Refer to section 4.8.

Erasing lost target mark

To erase the lost target mark, use the cursor pad to move the cursor over the lost target mark and press the **CANCEL/HL OFF** key. When you keep it blinking, it will disappear automatically after about one minute.

Erasing all lost target

1. Press the **MENU** key to open the menu.
2. Select [AIS], then press the **ENTER** key.
3. Select [Erase Lost Targets], then press the **ENTER** key. A confirmation message appears.
4. Use the cursorpad (**▲**) to select [Yes], then press the **ENTER** key. All lost targets symbols are erased from the screen and the long beep sounds.
5. Press the **MENU** key to close the menu.

5.14 Symbol Color

You can select the AIS symbol color among Green, Red, Blue, White or Black.

Note: Symbol colors are not available when [Background Color] (located in the [Brill/Color] menu) is set to the same color.

1. Press the **MENU** key to open the menu.
2. Select [AIS], then press the **ENTER** key.
3. Select [Color], then press the **ENTER** key.
4. Select the color, then press the **ENTER** key.
5. Press the **MENU** key to close the menu.

5.15 How to Ignore Slow Targets

You can prevent activation of the CPA/TCPA alarm against AIS targets that are traveling at a speed lower than set here. The AIS symbols are not affected by this setting.

1. Press the **MENU** key to open the menu.
2. Select [AIS], then press the **ENTER** key.
3. Select [Ignore Slow Targets], then press the **ENTER** key.
4. Set speed (0.0 to 9.9 kn), then press the **ENTER** key.
5. Press the **MENU** key to close the menu.

5.16 How to Show, Hide the Ship Names

Follow the steps below to show or hide the ship name of AIS targets.

1. Press the **MENU** key to open the menu.
2. Select [AIS], then press the **ENTER** key.
3. Select [Display Ship Name], then press the **ENTER** key.
4. Select [On] or [Off] and press the **ENTER** key.
 - [On]: Show the ship names.
 - [Off]: Hide the ship names.
5. Press the **MENU** key to close the menu.

5.17 How to Customize AIS

Follow the steps below to change an AIS target's symbol color..

1. Press the **MENU** key to open the menu.
2. Select [AIS], then press the **ENTER** key.

5. AIS OPERATION

3. Select [Customized AIS], then press the **ENTER** key.

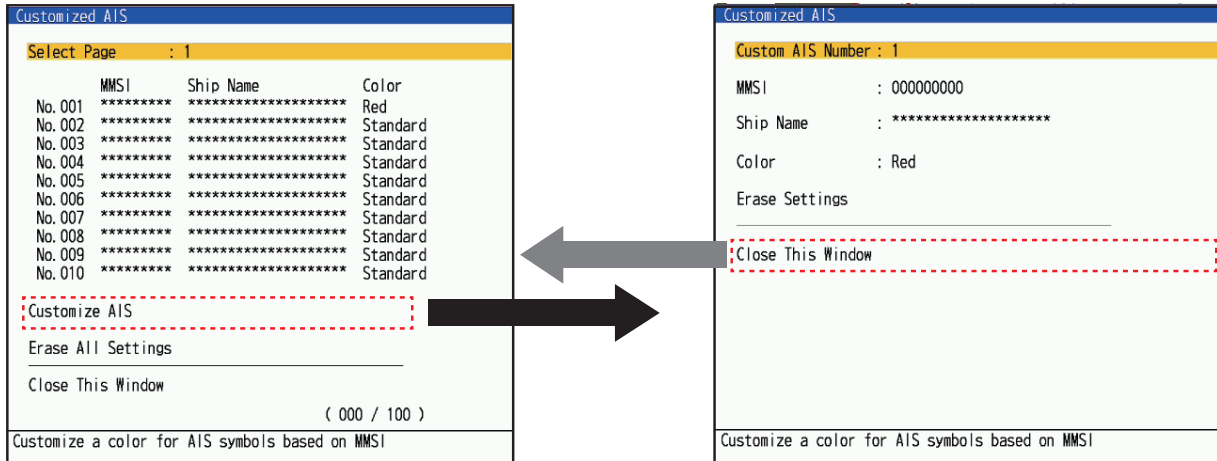

4. Select [Custom AIS] on the [Customized AIS] menu, and then press the **ENTER** key to move to the Setup window.
5. Select [Custom AIS Number], then press the **ENTER** key. Select AIS number for which to change its symbol color, then press the **ENTER** key.
6. Select [Color], and press the **ENTER** key

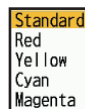

7. Press **▲** or **▼** on the cursor pad to select a color, then press the **ENTER** key.
8. Press the **MENU** key to close the menu.

Setting with [F1], [F2] or [F3] key

You can easily change the color of a displayed AIS symbol by customizing the function keys ([F1], [F2] or [F3]).

1. Press the **MENU** key to open the menu.
2. Press **▲** or **▼** on the cursor pad to select [Others] and press the **ENTER** key.
3. Press **▲** or **▼** on the cursor pad to select [F1 Setup] and press the **ENTER** key. [F2 Setup], [F3 Setup] is also available.
4. Press **▲** or **▼** on the cursor pad to select the color you want to set.
5. Press the **MENU** key to close the menu.
6. Move the cursor to select the symbol you want to change and press [F1](or [F2], [F3]).
The the symbol is painted in the color selected at step 4.

5.18 How to Customize Fishing Vessel's Symbol

You can change the symbol color of AIS targets identified as fishing vessels, to distinguish them from other AIS targets.

1. Press the **MENU** key to open the menu.
2. Select [AIS], then press the **ENTER** key.
3. Select [Fishing Vessel Col.], then press the **ENTER** key.
4. Set color, then press the **ENTER** key.
5. Press the **MENU** key to close the menu.

5.19 How to Use the Risk Visualizer™ function

The Risk Visualizer™ function identifies AIS targets (and TT) which may be on a collision course with own ship. See section 4.14 for details.

This page is intentionally left blank.

6. RADIO OPERATION

When the FURUNO DSB transceiver DR-100 (or DM-200) is connected to this radar, the tracks and marks of up to 51 vessels can be shown.

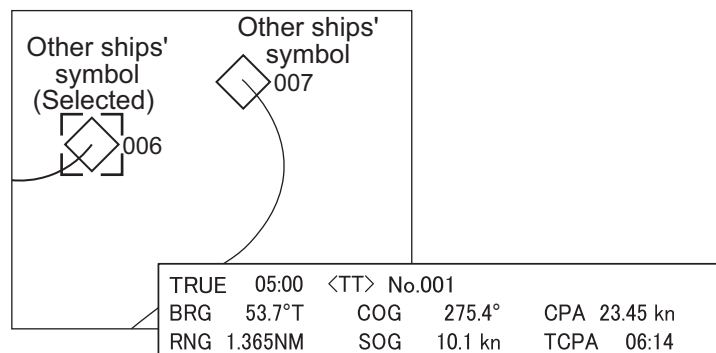

Note: The DR-100 and DM-200 are available in Japan only.

6.1 Radio Display On/Off

You can turn the radio display on or off as shown below.

1. Press the **MENU** key to open the menu.
2. Select [Radio], then press the **ENTER** key.
3. Select [Display], then press the **ENTER** key.

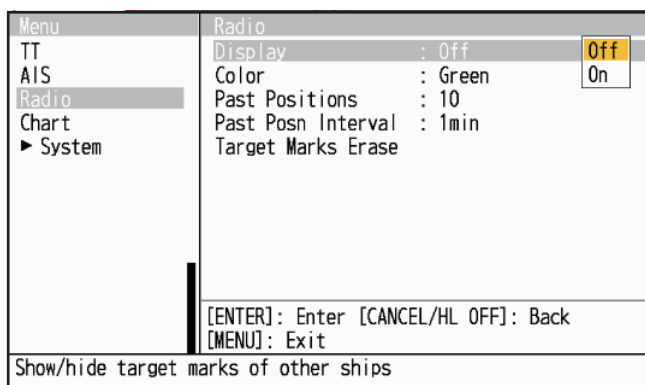

4. Select [Off] or [On], then press the **ENTER** key.
 - [Off]: Hide ship tracks and marks.
 - [On]: Show ships' tracks and marks (up to 51).
5. Press the **MENU** key to close the menu.

6.2 Symbol Color

You can select the other ships' symbol color among green, red, blue, white or black.

1. Press the **MENU** key to open the menu.
2. Select [Radio], then press the **ENTER** key.

6. RADIO OPERATION

3. Select [Color], then press the **ENTER** key.

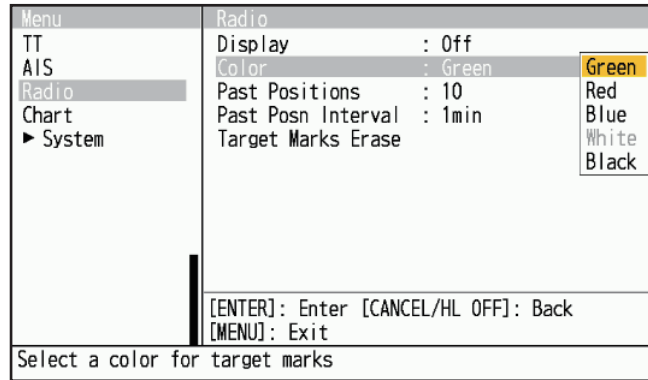

4. Select a color, then press the **ENTER** key.
5. Press the **MENU** key to close the menu.

Note: Symbols can not be shown in the same color as the background color.

6.3 Past Position Display

You can select the number of past position dots to display.

1. Press the **MENU** key to open the menu.
2. Select [Radio], then press the **ENTER** key.
3. Select [Past Positions], then press the **ENTER** key.

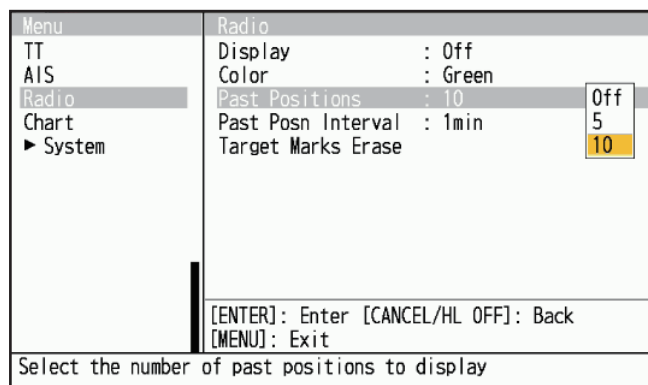

4. Select number of past position dots to display (5 or 10) or select [Off] to turn off the history display.
5. Press the **ENTER** key.
6. Press the **MENU** key to close the menu.

6.4 Past Position Interval

You can select the time interval to display the dots.

1. Press the **MENU** key to open the menu.
2. Select [Radio], then press the **ENTER** key.

3. Select [Past Posn Interval], then press the **ENTER** key.

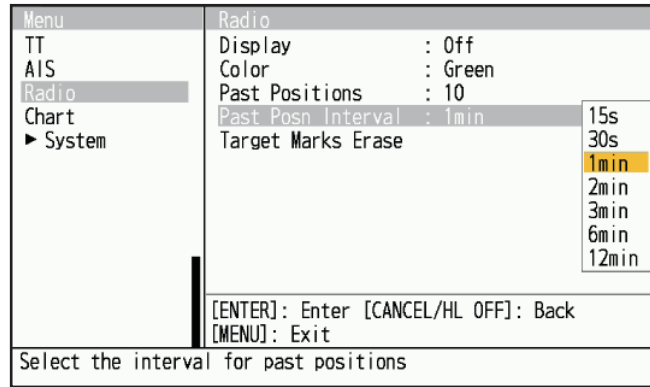

4. Select the time interval, then press the **ENTER** key.
5. Press the **ENTER** key.
6. Press the **MENU** key to close the menu.

6.5 How to Erase Target Tracks

You can erase target marks (trails) from the display. A buzzer sounds after marks are erased.

1. Press the **MENU** key to open the menu.
2. Select [Radio], then press the **ENTER** key.
3. Select [Target Marks Erase], then press the **ENTER** key.
4. A confirmation message appears.
5. Push ▲ on the cursorpad to select [Yes] then press the **ENTER** key.

6. RADIO OPERATION

This page is intentionally left blank.

7. CHART OVERLAY

Chart data can be overlaid by installing RP board on the FR-12.

Note: When [Display Chart] is set to [Off], this menu is unavailable.

7.1 How to Show, Hide the Chart Display

Chart display can be switched [On] or [Off] as shown below.



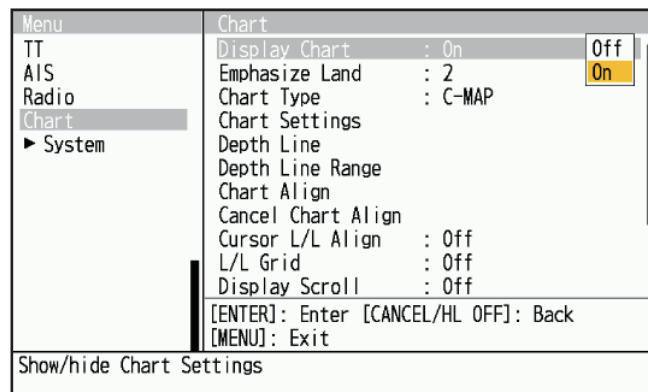

Note: LAT/LON data and HDG data are required to use the chart.

1. Press the **MENU** key to open the menu.
2. Select [Chart], then press the **ENTER** key.
3. Select [Display Chart], then press the **ENTER** key.



4. Select [Off] or [On], then press the **ENTER** key.
 - [Off]: Chart overlay is not displayed.
 - [On]: Chart overlay is displayed.
5. Press the **MENU** key to close the menu.

Chart icons

Icon	Meaning	After Correction
	The chart is displayed with an appropriate scale.	→ 
	The chart is displayed with an inappropriate scale. Adjust the scale with the [+] or [-] keys in the range.	→ 
	Chart file does not exist.	Not shown.

7.2 How to Emphasize Land

Select the level of landmass emphasis as shown below.

1. Press the **MENU** key to open the menu.
2. Select [Chart], then press the **ENTER** key.
3. Select [Emphasize Land], then press the **ENTER** key.

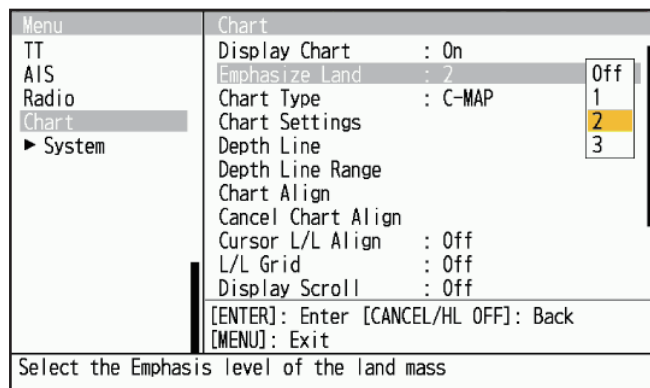

4. Select [Off], [1], [2] or [3] then press the **ENTER** key.
The higher the value, the more that land is emphasized.
5. Press the **MENU** key to close the menu.

7.3 How to Select Chart Type

Select the chart type as shown below.

1. Press the **MENU** key to open the menu.
2. Select [Chart], then press the **ENTER** key.
3. Select [Chart Type], then press the **ENTER** key.

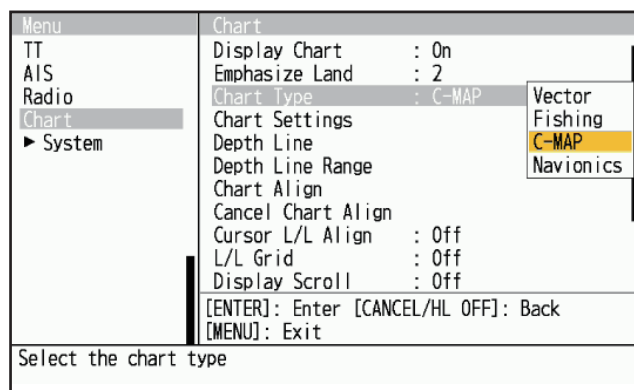

4. Select [Vector], [Fish], [C-MAP] or [Navionics] then press the **ENTER** key.
 - [Vector]: MapMedia vector chart.
 - [Fishing]: MapMedia fishing chart.
 - [C-MAP]: MapMedia navigational chart based on C-MAP data.
 - [Navionics]: MapMedia navigational chart based on Navionics data.
5. Press the **MENU** key to close the menu.

7.4 Chart Settings

The [Chart Settings] menu allows you to customize chart items as follows:

- Show or hide item.
 - Change color of item.
 - Change display method of item.
1. Press the **MENU** key to open the menu.
 2. Select [Chart], then press the **ENTER** key.
 3. Select [Chart Settings], then press the **ENTER** key..

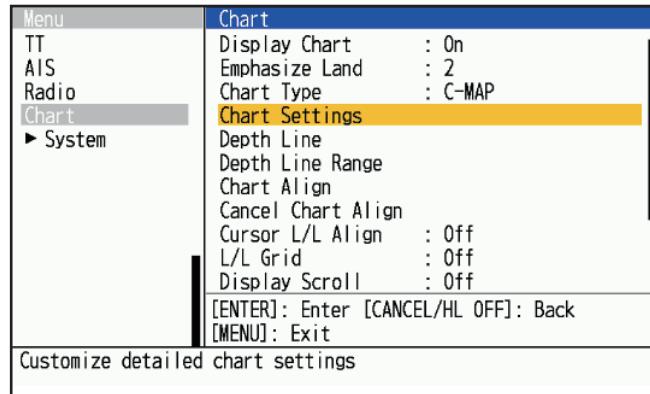

4. Select a menu item to change its settings, then press the **ENTER** key. Items not shown below can be shown or hidden as required.

Depth Lines				1/3▶
Water Depth	Line Type	Color	Disp Depth Line	
1m	—	■	No	
2m	—	■	No	
3m	—	■	No	
4m	—	■	No	
5m	—	■	No	
6m	—	■	No	
7m	—	■	No	
8m	—	■	No	
9m	—	■	No	
10m	—	■	No	
20m	—	■	Yes	
30m	—	■	Yes	
40m	—	■	Yes	
50m	—	■	Yes	
50m	—	■	Yes	

















[F1] : Show All [F2] : Hide All [F3] : Screen Shot
 [ENTER/ ↑/ ↓] : Select [CANCEL/HL OFF] : Close
 [←/→] : Move Page

- [Land Color]: Selects color for land among 9 colors.
 - [Land Contour Color]: Selects color for land edges among 15 colors.
 - [Background Color]: Selects color for background among six colors. Change the background color when targets and chart lines are hard to see.
 - [Marine Farm]: Select how to display a marine farm, by [Line] or [Line+Symbol].
5. Change the settings, then press the **ENTER** key.

7. CHART OVERLAY

- Press the **MENU** key to close the menu.

Mark examples

Name	Example	Name	Example	Name	Example
Light beacon/ buoy		Buoy		Bathymetry, Tidal current	
Fish bed		Obstacles		Obstacles under a safe area	
Fishing gear		Bottom discrimi- nation	Mud	Water quality	
Hazard area		Summits		Terrain	
Foghorn		Radio station		Service	
Harbor facilities		Small vessel service		Sounding	

7.5 Depth Line

You can turn the individual depth contour apart from chart depth contour.

- Press the **MENU** key to open the menu.
- Select [Chart], then press the **ENTER** key.
- Select [Depth Line], then press the **ENTER** key.
- Select a depth line to change the settings.
- Push **▲** or **▼** on the cursorpad to select depth line (1 to 4) then press the **ENTER** key.

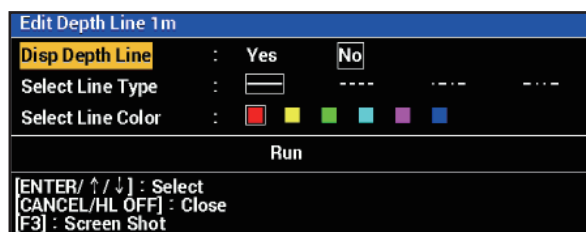

- After the setting is completed, press **CANCEL/HL OFF** key to close the setting menu.
- Press the **MENU** key to close the menu.

7.6 Depth Line Range

Up to 4 depth contour lines can be added to the selected range with the following procedures.

1. Press the **MENU** key to open the menu.
2. Select [Chart], then press the **ENTER** key.
3. Select [Depth Line Range], then press the **ENTER** key.

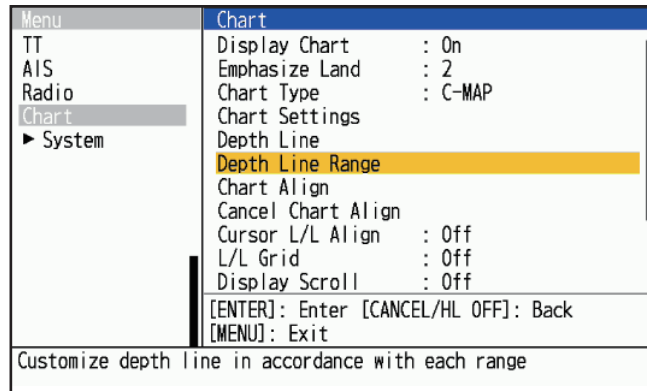

4. Select the range to display closely, then press the **ENTER** key.

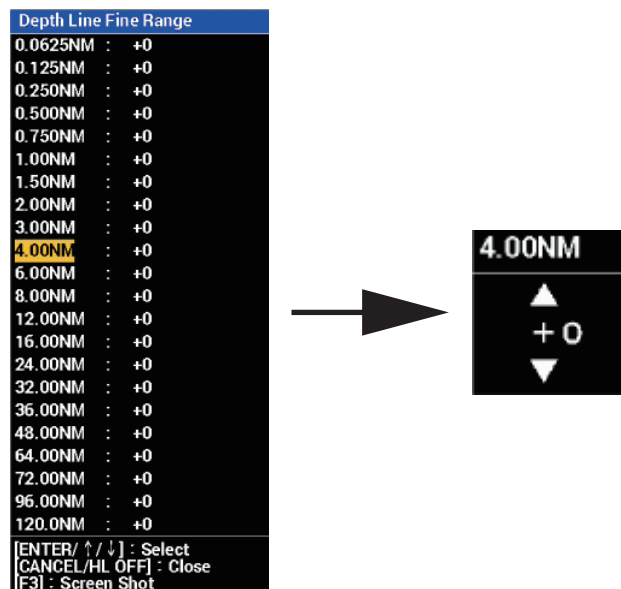

5. Push **▲** or **▼** on the cursorpad to select depth line (0 to +4) then press the **ENTER** key.
6. After the setting is completed, press **CANCEL/HL OFF** key to close the setting menu.
7. Press the **MENU** key to close the menu

7.7 Chart Align

You can correct the gap between the radar image and the chart by below procedure.

1. Press the **MENU** key to open the menu.
2. Select [Chart], then press the **ENTER** key.

7. CHART OVERLAY

3. Select [Chart Align], then press the **ENTER** key.
Show the radar image on the screen to close the menu.

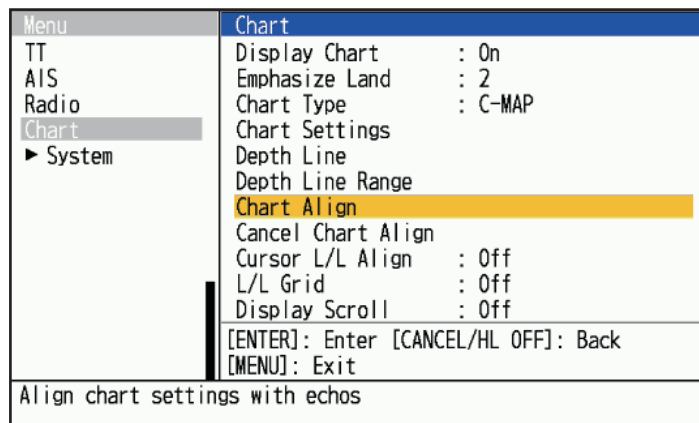

4. Push ▲ on the cursorpad to select [Yes] then press the **ENTER** key. Below confirmation window is shown.

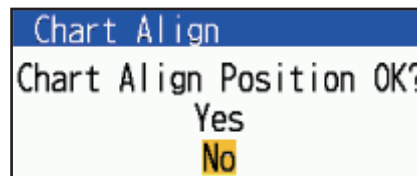

Note: When you cancel the chart alignment, select [Cancel Chart Align], then select [Yes] and press the **ENTER** key

5. Press the **MENU** key to close the menu

7.8 Cursor L/L Align

Select whether to align the Latitude/Longitude of the cursor. For the procedure, select [On] or [Off] from [Cursor L/L Align] on the [Chart] menu as in section 7.7. When "On" is selected in this menu and chart correction is done, the cursor position (latitude/longitude) will also change in conjunction with the chart correction. When [Off] is selected in this menu, the cursor position will not change regardless of whether chart correction is done or not.

7.9 L/L Grid

You can select the L/L grid to be shown or not.

1. Press the **MENU** key to open the menu.
2. Select [Chart], then press the **ENTER** key.
3. Select [L/L Grid], then press the **ENTER** key.
4. Select [On] or [Off], then press the **ENTER** key.
5. Press the **MENU** key to close the menu.

7.10 Display Scroll

When the cursor is placed over the edge of the radar screen in SYBY mode, the screen scrolls in the direction of the cursor.

Note: To return the screen moved by scrolling the screen to the center of the ship's position, press the **OFF CENTER** key.

1. Press the **MENU** key to open the menu.
2. Select [Chart], then press the **ENTER** key.
3. Select [Display Scroll], then press the **ENTER** key.
4. Select [On] or [Off], then press the **ENTER** key.
When [Off] is selected, display scroll is unavailable.
5. Press the **MENU** key to close the menu

7.11 Display Ext Marks

When the GP-3700/F is connected, GP-3700/F's marks can be shown (HUB is required). Also refer to the GP-3700/F manual for the mark transfer procedure.

- The maximum number of external marks can be displayed on the FR-12 screen is 30,000.
 - FR-12 can back up external marks transferred from GP-3700/F.
 - Refer to check the number of external mark points transferred from GP-3700 on FR-12.
1. Press the **MENU** key to open the menu.
 2. Use ▲ or ▼ to select [Chart], then press the **ENTER** key.
 3. Select [Display Ext Marks], then press the **ENTER** key.
 4. Push ▲ on the cursorpad to select [Yes] then press the **ENTER** key.
 5. Press the **MENU** key to close the menu.

Note 1: When you cancel to show the external marks, press **CANCEL/HL OFF** key and select [Yes] on the message window. A long buzzer sounds upon the erasing.

Note 2: When the displayed marks between FR-12 and GP-3700/F do not match, check the filter for mark transfer on GP-3700/F is not set.

Note 3: When the filter for mark transfer on GP-3700/F is not set and the displayed marks do not match, do the [Erase Ext Marks] on FR-12 and after then, transfer the marks from GP-3700/F again.





Note 4: When transferring marks from GP-3700/F, set the [Ext Mark Display] of FR-12 to [On]. Do not turn the [Ext Mark Display] menu [Off] during transferring the mark. While set to [Off], the FR-12 will not receive the external mark being transferred from the GP-3700 / F.

7. CHART OVERLAY

This page is intentionally left blank.

8. MAINTENANCE, TROUBLE-SHOOTING

This chapter has information about maintenance and troubleshooting that the user can follow to care for the equipment.

 WARNING	
	ELECTRICAL SHOCK HAZARD Do not open the equipment. Only qualified personnel can work inside the equipment.
	Turn off the power before you service the antenna unit. Post a warning sign near the power switch indicating that the power should be left off while you are servicing the antenna unit.
	Prevent the potential risk of being struck by the rotating antenna and exposure to RF radiation hazard.
	When you work on the antenna unit, wear a safety belt and hard hat. Serious injury or death can result if a person falls from the radar antenna mast.

NOTICE
Do not apply paint, anti-corrosive sealant or contact spray to plastic parts or equipment coating. Those items contain products that can damage plastic parts and equipment coating.

8.1 Preventive Maintenance

Regular maintenance helps keep your equipment in good condition and prevents future problems. Check the items shown in the table below to help keep your equipment in good condition for years to come.

Interval	Item	Check point	Remedy
When necessary	LCD	Dust on the LCD	Remove the dust from the LCD with the tissue paper and an LCD cleaner. To remove dirt or salt, use the LCD cleaner. Change the tissue paper often so as not to scratch the LCD.
3 to 6 months	Ground terminal on display unit	Check for tight connection and rust.	Tighten or replace as necessary.
	Display unit connectors	Check for tight connection.	Tighten if the connectors are loosened.
	Exposed nuts and bolts on the antenna unit	Check for corroded or loosened bolts.	Clean and repaint as necessary. Use sealing compound instead of paint.
	Antenna radiator	Check for dirt and cracks on the radiator surface.	Clean radiator surface with freshwater-moistened cloth. Do not use plastic solvents to clean.

8.2 Fuse Replacement

The fuse on the power cable protects the equipment from overcurrent and equipment fault. If the fuse blows, find the cause before you replace the fuse. Use the correct fuse. A wrong fuse can damage the equipment. If the fuse blows again, contact your dealer for advice.

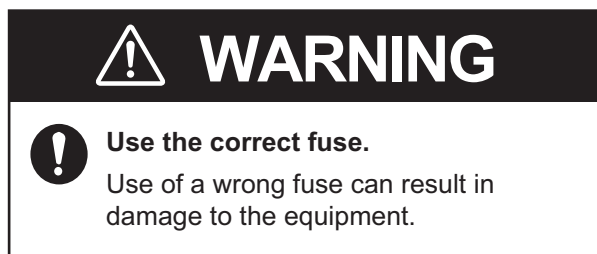

Model	Type	Code No.	Remarks
FR-10	FGBO-A 250V 2A PBF	000-155-829-10	For 24 VDC, Supplied as spare parts.*
	FGBO-A 125V 2A PBF	000-155-849-10	For 12 VDC, Pre-installed in power cable.
FR-12	FGBO-A 250V 3A PBF	000-155-841-10	For 24 VDC, Supplied as spare parts.*
	FGBO-A 125V 3A PBF	000-155-850-10	For 12 VDC, Pre-installed in power cable.

*: The supplied spare fuse is compatible with the pre-installed fuse.

8.3 Simple Troubleshooting

This section provides simple troubleshooting procedures which the user can follow to restore normal operation. If you cannot restore normal operation, do not check inside the unit. Have a qualified technician check the equipment.

Simple troubleshooting

Problem	Remedy
You cannot turn on the power.	<ul style="list-style-type: none"> • Check for blown fuse. • Check that the power connector is fastened. • Check for corrosion on the power cable connector. • Check for damaged power cable. • Check battery for correct voltage output.
There is no response when a key is pressed.	Turn the power off and on, then try operating the key again. If you do not get a response, the key is damaged. Contact your dealer for instructions.
Nothing displayed after pressing ϕ key.	Check that the signal cable between the display unit and the antenna unit is securely connected. Make sure the antenna is turned on.
The power is on and you operated the power key to transmit. The marks and characters appear, but no echoes appear.	Check that the antenna cable is fastened.
Tuning is correctly adjusted, but sensitivity is poor.	The magnetron may be faulty. Contact your dealer about replacement of the magnetron.

Problem	Remedy
Displayed image stops and does not update.	<ul style="list-style-type: none"> • Check that the antenna cable is fastened. • Reboot the display unit.
You can change the range, but the radar picture does not change.	Reset the power.
Poor discrimination in range because of many echoes from waves.	Adjust the sea clutter.
The true motion presentation is not working correctly.	<ul style="list-style-type: none"> • Check that the setting of [Display Mode] in the [Display] menu is set to [True Motion]. • Check if the heading and position data are input and correct.
The range rings are not displayed.	Check that the setting of [Rings Brill] in the [Brill/Color] menu is set to other than [Off].
Target is not tracked correctly because of sea clutter.	Adjust the sea clutter and rain clutter.
After switching to transmit (TX), the system switches back to stand-by (STBY).	<ul style="list-style-type: none"> • Check that the antenna cable is fastened. • Turn off the power, wait for a few seconds and reboot.

8.4 Advanced-level Troubleshooting

This section provides hardware and software troubleshooting procedures for the qualified serviceman.

Advanced-level troubleshooting

Problem	Probable cause or check points	Remedy
Power cannot be turned on.	<ol style="list-style-type: none"> 1) Mains voltage/polarity 2) MAIN board 	<ol style="list-style-type: none"> 1) Correct the wiring and input voltage. 2) MAIN supply board.
Brilliance adjusted but no picture, characters or marks.	<ol style="list-style-type: none"> 1) MAIN Board 	<ol style="list-style-type: none"> 1) Replace the MAIN board.
Antenna not rotating.	<ol style="list-style-type: none"> 1) Antenna drive mechanism 	<ol style="list-style-type: none"> 1) Replace the antenna drive mechanism.
The picture has "frozen".	<ol style="list-style-type: none"> 1) Heading sensor inside antenna unit 2) MAIN board 	<ol style="list-style-type: none"> 1) Replace SPU/IF-SPU board. 2) Replace MAIN board. 3) Turn radar off and on.
Radar is correctly tuned but sensitivity is poor.	<ol style="list-style-type: none"> 1) Dirt on radiator face 2) Deteriorated magnetron 3) Detuned MIC 	<ol style="list-style-type: none"> 1) Clean the radiator. 2) Check the magnetron current with radar on max. range. If the current is below normal, magnetron may be defective. Replace the magnetron. 3) Restore default tuning. Replace MIC.
Range picture does not change when range is changed.	<ol style="list-style-type: none"> 1) MAIN Board 2) SPU board 	<ol style="list-style-type: none"> 1) Replace MAIN Board. 2) Turn radar off and on.
Range rings are not displayed.	<ol style="list-style-type: none"> 1) Adjust their brilliance on the [Brill/Color] menu. 2) MAIN Board 	<ol style="list-style-type: none"> 1) Replace associated circuit board if unsuccessful. 2) Replace MAIN Board.

Problem	Probable cause or check points	Remedy
TT / AIS, marks, or charts are not displayed. TT and signal processing do not work properly.	1) Navigation data is not input correctly.	1) Check the cable connection. 2) Check the baud rate settings. 3) Check the correct values are displayed on the device from which the data is output. 4) Check the required sentences or PGNs are output. 5) Check the device connected to the LAN outputs unnecessary sentences.

8.5 Diagnostic Tests

You can run diagnostic tests for several components of your radar system. These tests require access to the [System] menu, which is locked by default. To access the [System] menu, consult your local dealer or qualified technician.

1. Press the **MENU** key to open the menu.
2. Access the [System] menu.
3. Select [Tests], then press the **ENTER** key.
4. Select [Self Test], then press the **ENTER** key.

Key, buzzer, knob control and Cursorpad check

MAIN Unit Test	
MODEL NAME	:FR-12
BOOTER VERSION	:0359521-XX.XX
APPLICATION VERSION	:0359522-XX.XX
FPGA VERSION	:0359523-XX.XX
IP ADDRESS	:172.031.003.036
MAC ADDRESS	:00-D0-1D-5A-5B-4C
ROM	:OK
RAM	:OK
5V	:4.9 V
12V	:12.0 V
BACKLIGHT VOLTAGE	:28.5 V
MAIN TEMPERATURE	:46.0 °C
USB MEMORY	:OK
CAN UNIQUE NUMBER	:0055000
SERIAL NUMBER	:1001-3000-0000
FONT VERSION	:0359524-XX.XX
LANGUAGE VERSION	:0359525-XX.XX
LANGUAGE OTHER1	:
LANGUAGE OTHER2	:

[MENU]×3 : Exit
 [F1] : Alarm Test
 [F2]×3 : Save
 [F3]×3 : Screen Shot

Start the main unit test

XX.XX: Program version no.

5. Press the **MENU** key three times to close the test results.
6. Press the **MENU** key to close the menu.

8.6 LCD Test

1. Press the **MENU** key to open the menu.
2. Access the [System] menu.
3. Select [Tests], then press the **ENTER** key.
4. Select [LCD Test], then press the **ENTER** key.

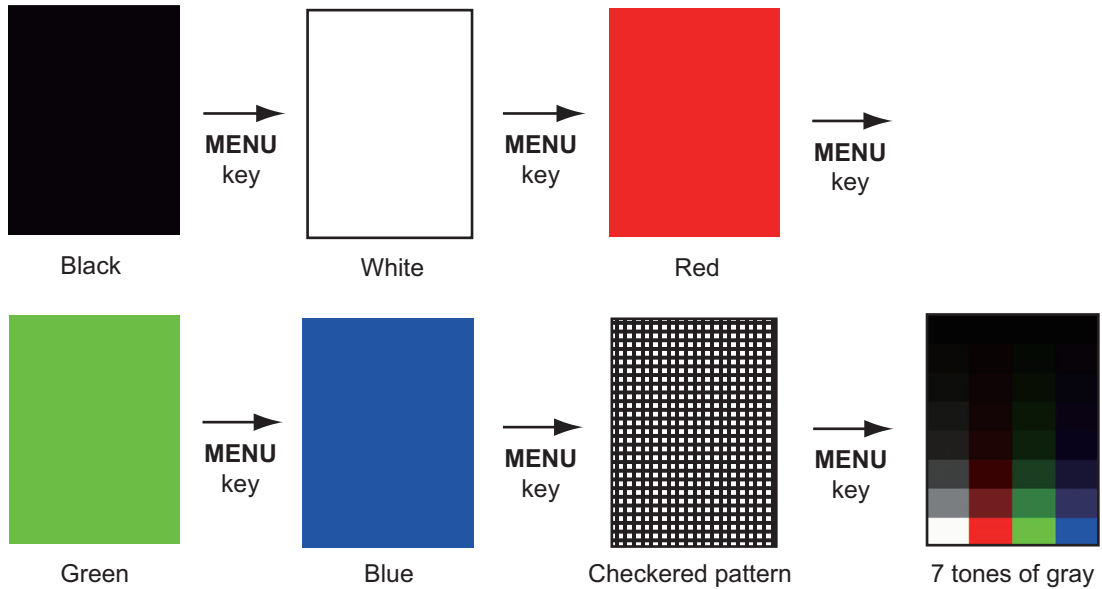

5. Press the **MENU** key several times to close the menu.

Note: You can adjust the screen brilliance with the ϕ key during the test.

8.7 RP Unit Test

RP unit can be checked for proper operation as follows..

1. Press the **MENU** key to open the menu.
2. Access the [System] menu.
3. Select [Tests], then press the **ENTER** key.
4. Select [RP Unit Test], then press the **ENTER** key.

RP Unit Test	
1st BOOTER VERSION	:0359527-XX.XX
2nd BOOTER VERSION	:0359528-XX.XX
APPLICATION VERSION	:0359530-XX.XX
OS VERSION	:0359529-XX.XX
5V	:4.94 V
3.3V	:3.30 V
RP TEMPERATURE	:32.0 °C
CHART MEMORY	:OK
USB MEMORY	:**
NUMBER OF EXT MARKS	:0

[MENU]: Exit [F2]: Save [F3]: Screen Shot

5. Press the **MENU** key several times to close the menu.

8.8 Radar Sensor Test

This test checks the connected antenna unit for proper operation.

1. Press the **MENU** key to open the menu.
2. Access the [System] menu.
3. Select [Tests], then press the **ENTER** key.
4. Select [Radar Sensor Test], then press the **ENTER** key. The test results appear in a similar manner as the following figure.

```

Radar Sensor Test
MODEL NAME          .***
BOOTER VERSION      .*****_** **
APPLICATION VERSION .*****_** **
FPGA VERSION        .*****_** **
IP ADDRESS          .*** ** ** **
MAC ADDRESS         .**_**_**_**_**_**
ROM                 .**
RAM                 .**
HEADING PULSE       .**
BEARING PULSE       .**
VIDEO STATUS        .**
TUNING VOLTAGE      .**.* V
TUNE INDICATOR      .***
TOTAL ON TIME       .*****.* H
TOTAL TX TIME       .*****.* H
ANTENNA ROTATION    .**.* rpm
TX-HV               .***.* V
MAGNETRON MONITOR   .**.* V
MAGNETRON HEATER    .**.* V
5V                  .**.* V
12V                 .**.* V
PULSE VOLTAGE CONTROL .**.* V
A3.3V               .**.* V

[MENU]: Exit [F2]: Save [F3]: Screen Shot

```

Note 1: Below menus are unavailable when the DRS-NXT series radar is connected.

- TUNING VOLTAGE, TUNE INDICATOR, ANTENNA ROTATION, TX-HV, MAGNETRON MONITOR, MAGNETRON HEATER, PULSE VOLTAGE CONTROL and A3.3V.

Note 2: Below menus are unavailable when the DRS4DL+ is connected.

- MAGNETRON HEATER, PULSE VOLTAGE CONTROL, A3.3V

Note 3: Below menu is unavailable when the DRS4DX is connected.

- PULSE VOLTAGE CONTROL

Note 4: Below menu is unavailable when the DRS6A/12A/25A-NXT is connected.

8. MAINTENANCE, TROUBLESHOOTING

- 12V

Note 5: The description of MAGNETRON HEATER differs depending on the radar sensor type.

- DRS4DX: Display result as OK / NG.
- DRS6A / 12A / 25AX: Display result as voltage value.

5. Press the **MENU** key to close the test screen.

8.9 Chart Administration

Charts can be installed and updated on the FR12 when it is equipped with the RP board.

8.9.1 How to install charts

Save chart data to a USB flash memory, then do as follows to install the chart. (It is not necessary to create a folder in the flash memory).

1. Insert the USB flash memory containing the chart data into the insertion slot at the bottom left of the unit.
2. Press the **MENU** key to open the menu.
3. Use ▲ or ▼ to select [Chart], then press the **ENTER** key.
4. Use ▲ or ▼ to select [Update Chart], then press the **ENTER** key.
5. Use ▲ or ▼ to select [Yes], then press the **ENTER** key.
After the processing message disappears, the [Chart Administration] menu opens.

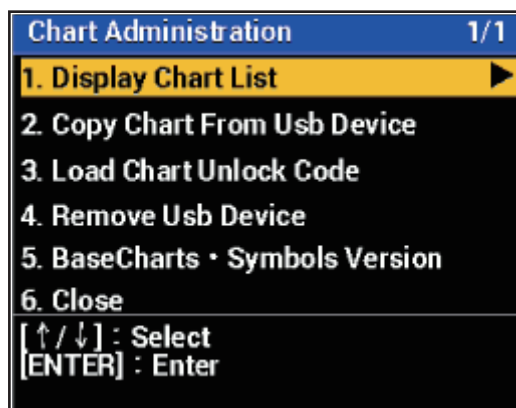

6. Select [Copy Chart From Usb device].
A confirmation message appears.
7. Select [Yes], then press the **ENTER** key.
If the chart was successfully copied, a message indicating copy completion appears.
8. Unlock the chart.
There are two unlocking methods, automatic and manual.

8. MAINTENANCE, TROUBLESHOOTING

10. Press **ENTER** key to remove the USB memory.
11. Select [Close], then press **ENTER** key.

8.9.2 How to update charts

To update a chart, you must delete the old chart, then install the new chart. Save chart data to a USB flash memory beforehand, then follow the procedure below. (It is not necessary to create a folder in the flash memory.) Save the unlock code as needed for backup.

1. Insert the USB flash memory containing the chart data into the insertion slot at the bottom left of the unit.
2. Press the **MENU** key to open the menu.
3. Use ▲ or ▼ to select [Chart], then press the **ENTER** key.
4. Use ▲ or ▼ to select [Update Chart], then press the **ENTER** key.
A message to restart the system appears.
5. Use ▲ or ▼ to select [Yes], then press the **ENTER** key.
After the “processing” message disappears, the [Chart Administration] menu opens.
6. Select [Display Chart List], then press the **ENTER** key.
7. Select the chart to delete, then press the **ENTER** key.
A confirmation message appears.
8. Select [Yes], then press the **ENTER** key.
9. Go to step 6 in section 8.9.1, to install the new chart.

APPX. 1 MENU TREE

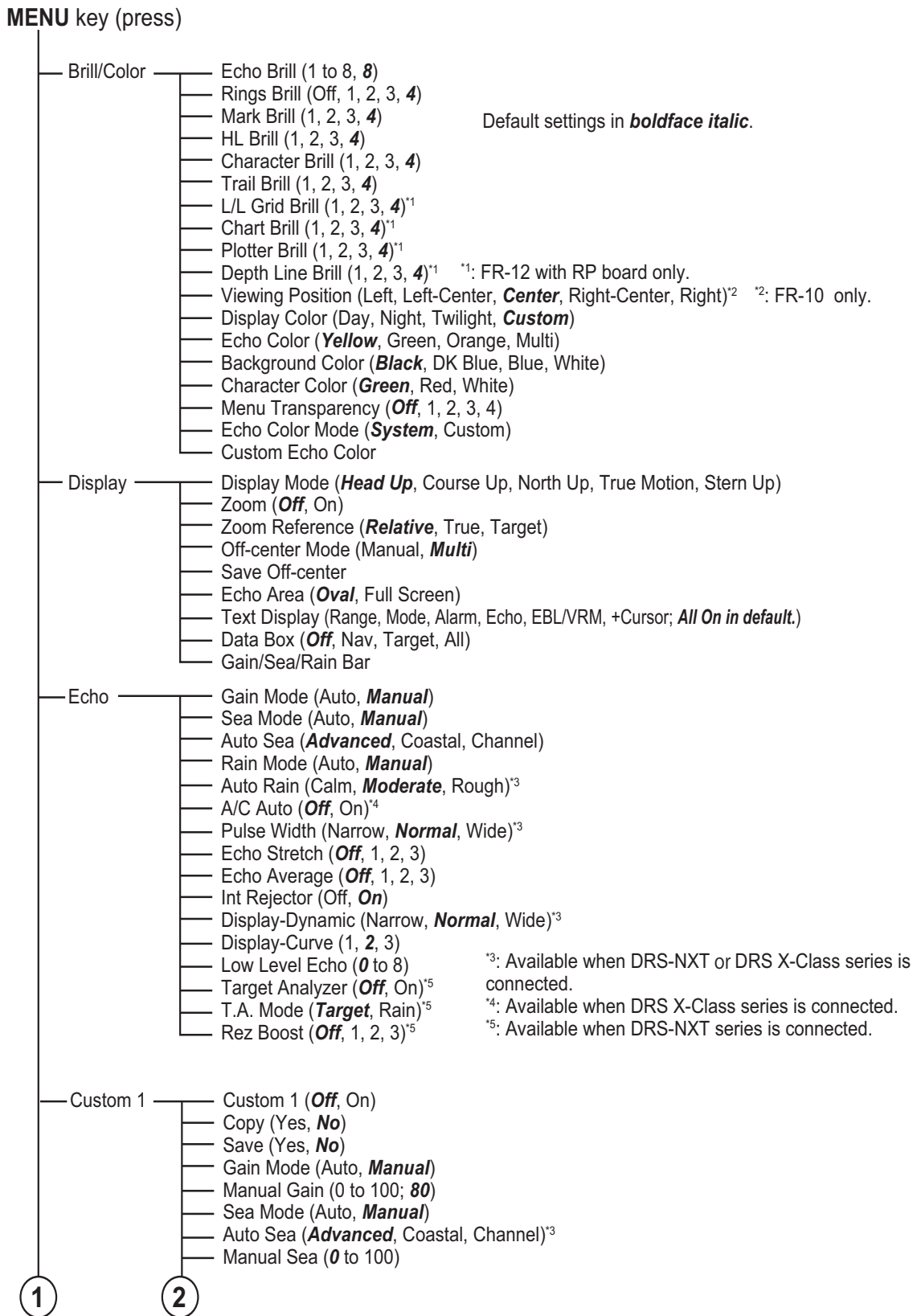

(Continued on following page)

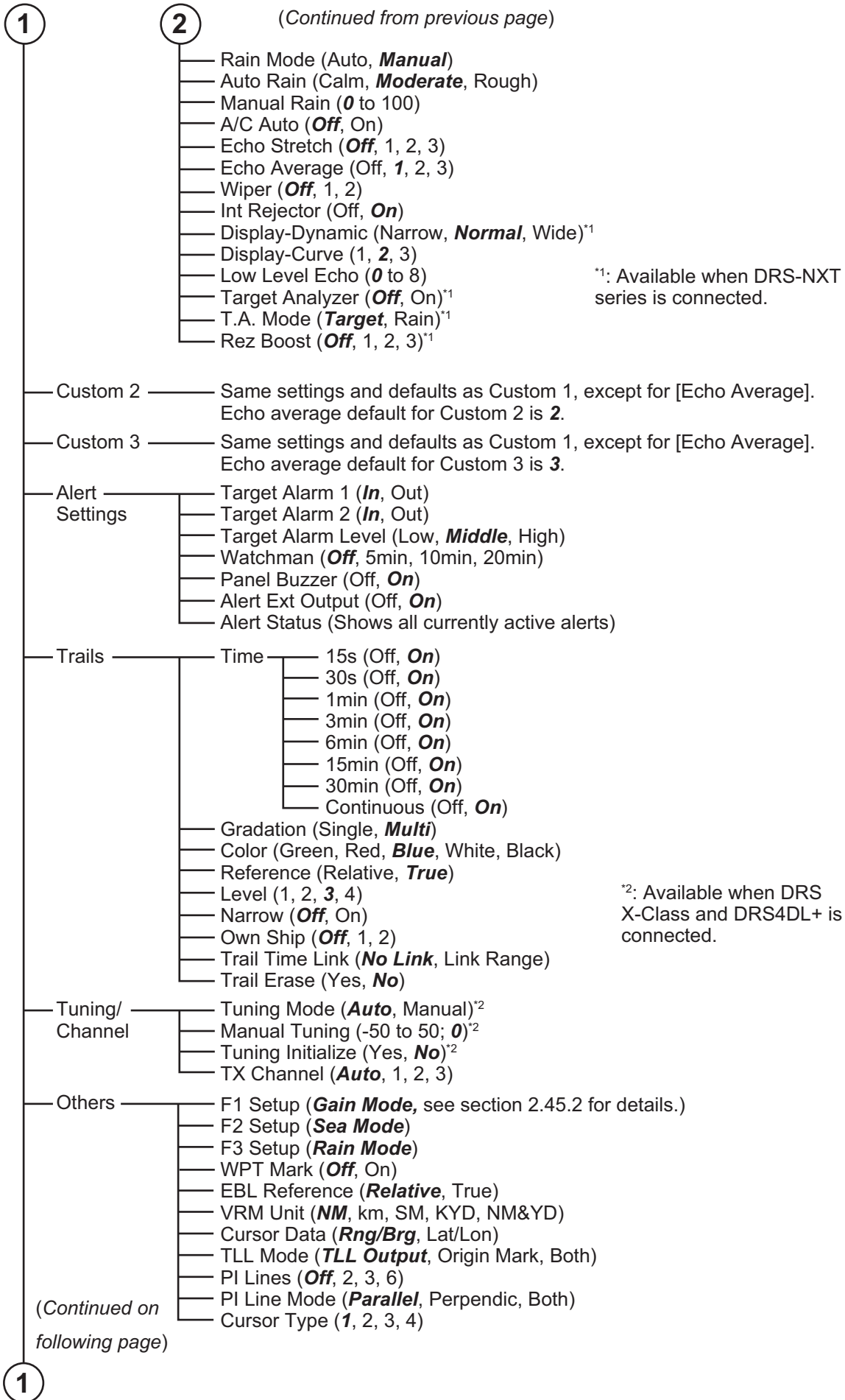

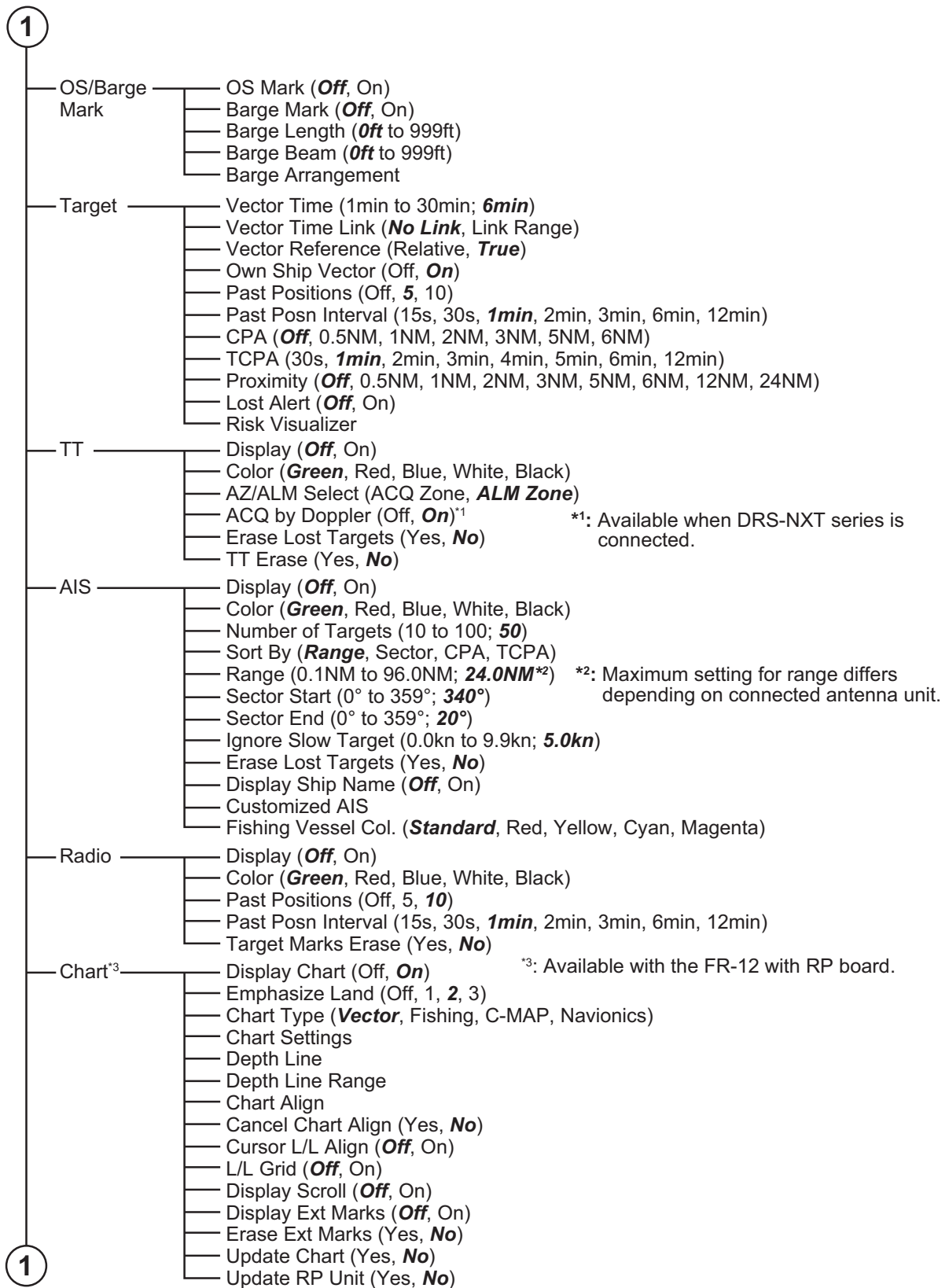

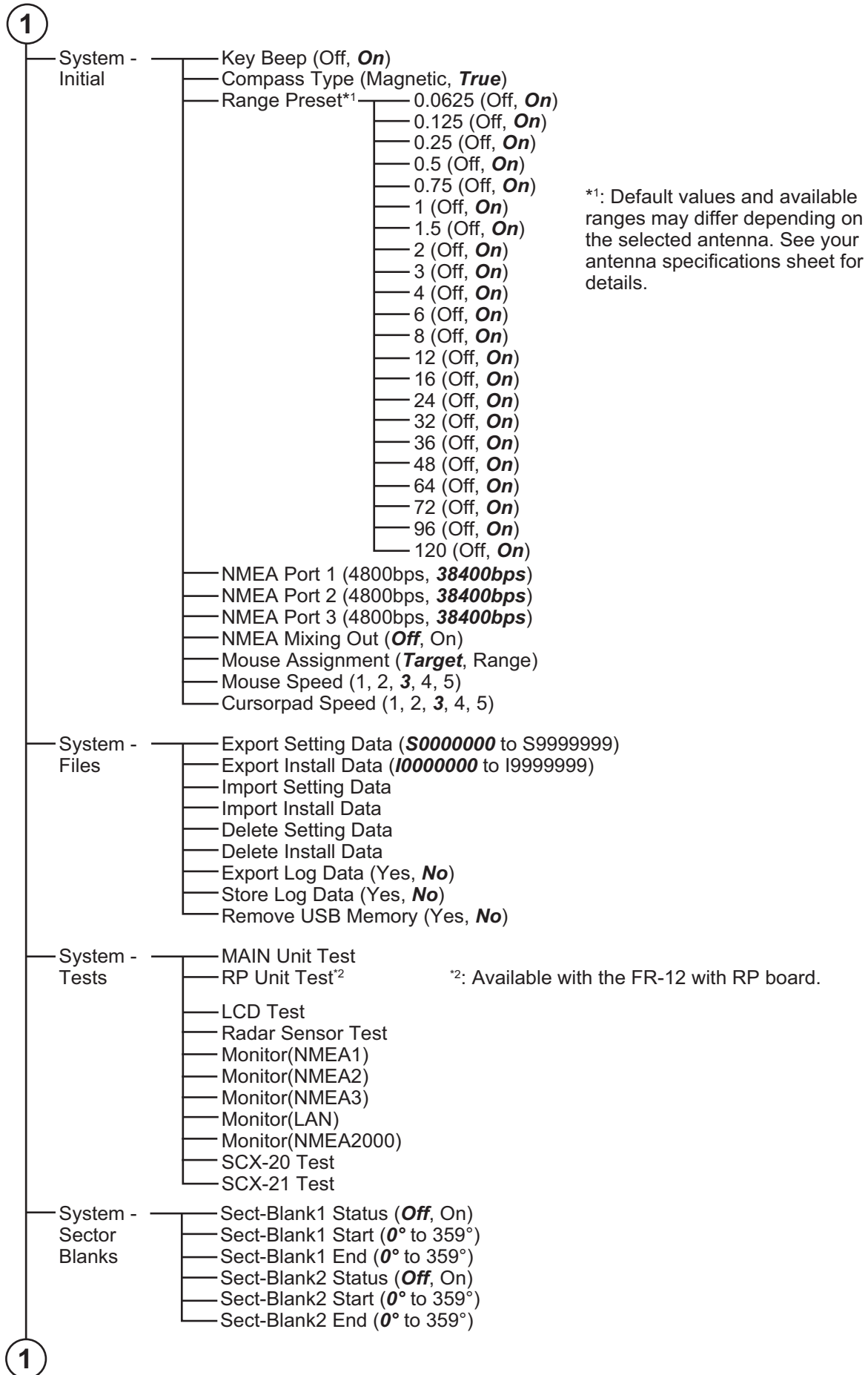

1

- System - Units*1
 - Range Unit (**NM**, km, SM)
 - Ship Speed Unit (**kn**, km/h, mph)
- System - TT Advanced*1
 - QV Display (**Off**, On)
 - Echo Level (**1** to 31)
 - Echo Size (**1** to 10)
 - Land Size (**100m** to 2000m)
 - Auto Acq. Corr. (**1** to 10)
 - Auto Acq. Erase (**1** to 10)
 - Gate Size (**1** to 10)
 - Filter Response (**1** to 10)
 - Lost Count (**1** to 20)
 - Target Vect Start (**Time**, Scan)
 - Start Time*2 (**0s**, 20s to 60s)
 - Start Scan*3 (**0**, 8 to 25)
 - Antenna Length (**1.0m**, 1.2m, 1.8m)
 - TT Default (Yes, **No**)

*1: Accessible only by qualified technician.
Do not change these settings.

*2: Available when [Target Vec Scan] is set to [Time].

*3: Available when [Target Vec Scan] is set to [Scan].

- System - SCX-20*1
 - SBAS Mode (Off, **On**)
 - Offset HDG (-180.0° to 180.0°; **0.0°**)
 - Offset Pitch (-10.0° to 10.0°; **0.0°**)
 - Offset Roll (-10.0° to 10.0°; **0.0°**)
 - Smoothing SOG/COG (0000s to 9999s; **0000s**)
 - Smoothing ROT (0s to 30s; **0s**)
 - PGN Settings
 - Factory Reset (Yes, **No**)

- System - SCX-21*1
 - Datum (**WG84**, WG72, Other)
 - Datum Number (**003** to 173)
 - SBAS Mode (Off, **On**)
 - Offset HDG (-180.0° to 180.0°; **0.0°**)
 - Offset Pitch (-10.0° to 10.0°; **0.0°**)
 - Offset Roll (-10.0° to 10.0°; **0.0°**)
 - Smoothing SOG/COG (0000s to 9999s; **0005s**)
 - Smoothing ROT (0s to 30s; **5s**)
 - Port1 Setting
 - Port2 Setting
 - Port3 Setting
 - Factory Reset

- System - Installation*1
 - Main/Sub Radar
 - NMEA LAN Output (Off, **On**)
 - TTM Output Setting (**Normal**, Legacy)
 - Own Ship Length (**15m** to 999m)
 - Own Ship Beam (**5m** to 999m)
 - RV.Alert Hysteresis (10min, 15min, 20min, 25min, **30min**, 60min, 100min)
 - Demo Mode (**Off**, Internal)
 - Demo Echo Type (**DRSX-Class**, DRS-NXT)
 - Antenna Rotation (**Rotate**, Stop)
 - Rotation Speed (**24rpm**, Auto)*4
 - STC Range (0 to 10; **3**)*4
 - Near STC Level (1 to 4; **2**)*4
 - A/C Auto Adjust (-10 to 10; **0**)*4
 - Heading Allignment (0.0° to 359.9; **0°**)
 - Sweep Timing (-10 to 10; **1**)
 - MBS Adjustment (**0** to 255)
 - Magnetron Readjust (Yes, **No**)*5
 - Total On Time (**000000.0H** to 999999.9H)
 - Total TX Time (**000000.0H** to 999999.9H)
 - Alert Out Type (**ExternalBuzzer**, AlarmOut, OperatorFitness)
 - Input Datum (**WGS-84**, Tokyo)
 - Geodetic Datum (**WGS-84**, Tokyo)
 - Memory Reset (Yes, **No**)

*4: Available when DRS-NXT, DRS X-Class series is connected.

*5: Available when DRS X-Class series is connected.

1

APPX. 1 MENU TREE

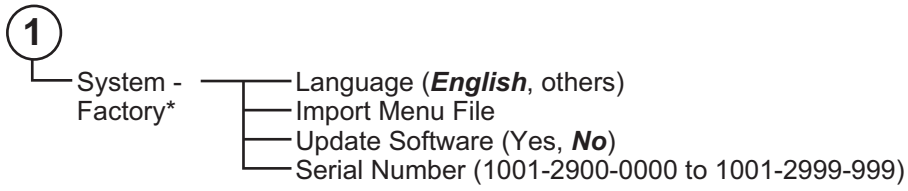

*: Accessible only by qualified technician.
Do not change these settings.

APPX. 2 GEODETIC CHART LIST

001: WGS84		
002: WGS72		
003: TOKYO	: Mean Value (Japan, Korea & Okinawa)	
004: NORTH AMERICAN 1927	: Mean Value (CONUS)	
005: EUROPEAN 1950	: Mean Value	
006: AUSTRALIAN GEODETIC 1984	: Australia & Tasmania	
007: ADINDAN-MN	: Mean Value (Ethiopia & Sudan)	
008: ADINDAN-E	: Ethiopia	
009: ADINDAN-MA	: Mali	
010: ADINDAN-SE	: Senegal	
011: ADINDAN-SU	: Sudan	
012: AFG	: Somalia	
013: AIN EL ABD 1970	: Bahrain Is.	
014: ANNA 1 ASTRO 1965	: Cocos Is.	
015: ARC 1950-MN	: Mean Value	
016: ARC 1950-B	: Botswana	
017: ARC 1950-L	: Lesotho	
018: ARC 1950-M	: Malawi	
019: ARC 1950-S	: Swaziland	
020: ARC 1950-ZR	: Zaire	
021: ARC 1950-ZM	: Zambia	
022: ARC 1950-ZB	: Zimbabwe	
023: ARC 1960-MN	: Mean Value (Kenya & Tanzania)	
024: ARC 1960-K	: Kenya	
025: ARC 1960-T	: Tanzania	
026: ASCENSION IS. 1958	: Ascension Is.	
027: ASTRO BEACON "E"	: Iwo Jima Is.	
028: ASTRO B4 SOR. ATOLL	: Tern Is.	
029: ASTRO POS 71/4	: St. Helena Is.	
030: ASTRONOMIC STATION 1952	: Marcus Is.	
031: AUSTRALIAN GEODETIC 1966	: Australia & Tasmania	
032: BELLEVUE (IGN)	: Efate & Erromango Is.	
033: BERMUDA 1957	: Bermuda Is.	
034: BOGOTA OBSERVATORY	: Columbia	
035: CAMPO INCHAUSPE	: Argentina	
036: CANTON IS. 1966	: Phoenix Is.	
037: CAPE	: South Africa	
038: CAPE CANAVERAL	: Mean Value (Florida & Bahama Is.)	
039: CARTHAGE	: Tunisia	
040: CHATHAM 1971	: Chatham Is. (New Zealand)	
041: CHUUA ASTRO	: Paraguay	
042: CORREGO ALEGRE	: Brazil	
043: DJAKARTA (BATAVIA)	: Sumatra Is. (Indonesia)	
044: DOS 1968	: Gizo Is. (New Georgia Is.)	
045: EASTER IS. 1967	: Easter Is.	
046: EUROPEAN 1950-WF	: Western Europe	
047: EUROPEAN 1950-CY	: Cyprus	
048: EUROPEAN 1950-EG	: Egypt	
049: EUROPEAN 1950-ESC	: England, Scotland, Channel & Shetland Is.	
050: EUROPEAN 1950-EIS	: England, Ireland, Scotland & Shetland Is.	
051: EUROPEAN 1950-GR	: Greece	
052: EUROPEAN 1950-IR	: Iran	
053: EUROPEAN 1950-SA	: Italy, Sardinia	
054: EUROPEAN 1950-SI	: Italy, Sicily	
055: EUROPEAN 1950-NF	: Norway & Finland	
056: EUROPEAN 1950-PS	: Portugal & Spain	
057: EUROPEAN 1979	: Mean Value	
058: GANDAJIKA BASE	: Republic of Maldives	
059: GEODETIC DATUM 1949	: New Zealand	
060: GUAM 1963	: Guam Is.	
061: GUX 1 ASTRO	: Guadalcanal Is.	
062: HJORSEY 1955	: Iceland	
063: HONG KONG 1963	: Hong Kong	
064: INDIAN-TV	: Thailand & Vietnam	
065: INDIAN-BIN	: Bangladesh, India & Nepal	
066: IRELAND 1965	: Ireland	
067: ISTS 073 ASTRO 1969	: Diego Garcia	
068: JOHNSTON IS. 1961	: Johnston Is.	
069: KANDAWALA	: Sri Lanka	
070: KERGUELEN IS.	: Kerguelen Is.	
071: KERTAU 1948	: West Malaysia & Singapore	
072: LA REUNION	: Mascarene Is.	
073: L. C. 5 ASTRO	: Cayman Brac Is.	
074: LIBERIA 1964	: Liberia	
075: LUZON	: Philippines (excl. Mindanao Is.)	
076: LUZON-M	: Mindanao Is.	
077: MAHE 1971	: Mahe Is.	
078: MARCO ASTRO	: Salvage Islands	
079: MASSAWA	: Eritrea (Ethiopia)	
080: MERCHICH	: Morocco	
081: MIDWAY ASTRO 1961	: Midway Is.	
082: MINNA	: Nigeria	
083: NAHRWAN-O	: Masirah Is. (Oman)	
084: NAHRWAN-UAE	: United Arab Emirates	
085: NAHRWAN-SA	: Saudi Arabia	
086: NAMIBIA	: Namibia	
087: MAPARIMA, BWI	: Trinidad & Tobago	
088: NORTH AMERICAN 1927WU	: Western United States	
089: NORTH AMERICAN 1927EU	: Eastern United States	
090: NORTH AMERICAN 1927AK	: Alaska	
091: NORTH AMERICAN 1927BH	: Bahamas (excl. San Salvador Is.)	
092: NORTH AMERICAN 1927SS	: Bahamas, San Salvador Is.	
093: NORTH AMERICAN 1927CN	: Canada (incl. Newfoundland Is.)	
094: NORTH AMERICAN 1927AB	: Alberta & British Columbia	
095: NORTH AMERICAN 1927EC	: East Canada	
096: NORTH AMERICAN 1927MO	: Manitoba & Ontario	
097: NORTH AMERICAN 1927NE	: Northwest Territories & Saskatchewan	
098: NORTH AMERICAN 1927YK	: Yukon	
099: NORTH AMERICAN 1927CZ	: Canal Zone	
100: NORTH AMERICAN 1927CR	: Caribbean	
101: NORTH AMERICAN 1927CA	: Central America	
102: NORTH AMERICAN 1927CU	: Cuba	
103: NORTH AMERICAN 1927GR	: Greenland	
104: NORTH AMERICAN 1927MX	: Mexico	
105: NORTH AMERICAN 1983AK	: Alaska	
106: NORTH AMERICAN 1983CN	: Canada	
107: NORTH AMERICAN 1983CS	: CONUS	
108: NORTH AMERICAN 1983MX	: Mexico, Central America	
109: OBSERVATORIO 1966	: Corvo & Flores Is. (Azores)	
110: OLD EGYPTIAN 1930	: Egypt	
111: OLD HAWAIIAN-MN	: Mean Value	
112: OLD HAWAIIAN-HW	: Hawaii	
113: OLD HAWAIIAN-KA	: Kauai	
114: OLD HAWAIIAN-MA	: Maui	
115: OLD HAWAIIAN-OA	: Oahu	
116: OMAN	: Oman	
117: ORDNANCE SURVEY OF GREAT BRITAIN 1936-NM	: Mean Value	
118: ORDNANCE SURVEY OF GREAT BRITAIN 1936-E	: England	
119: ORDNANCE SURVEY OF GREAT BRITAIN 1936-IM	: England, Isle of Man & Wales	
120: ORDNANCE SURVEY OF GREAT BRITAIN 1936-SSI	: Scotland & Shetland Is.	
121: ORDNANCE SURVEY OF GREAT BRITAIN 1936-WL	: Wales	
122: PICO DE LAS NIVIAS	: Canary Is.	
123: PITCAIRN ASTRO 1967	: Pitcairn Is.	
124: PROVISIONS SOUTH CHILEAN 1963: South Chile (near 53°S)		
125: PROVISIONAL SOUTH AMERICAN 1956MN: Mean Value		
126: PROVISIONAL SOUTH AMERICAN 1956BO: Bolivia		
127: PROVISIONAL SOUTH AMERICAN 1956NC: Chile-Northern Chile (near 19°S)		
128: PROVISIONAL SOUTH AMERICAN 1956SC: Chile-Southern Chile (near 43°S)		
129: PROVISIONAL SOUTH AMERICAN 1956CO: Columbia		
130: PROVISIONAL SOUTH AMERICAN 1956EC: Ecuador		
131: PROVISIONAL SOUTH AMERICAN 1956GY: Guyana		
132: PROVISIONAL SOUTH AMERICAN 1956PR: Peru		
133: PROVISIONAL SOUTH AMERICAN 1956VN: Venezuela		
134: PUERTO RICO	: Puerto Rico & Virgin Is.	
135: QATAR NATIONAL	: Qatar	
136: QORNOQ	: South Greenland	
137: ROME 1940	: Sardinia Is.	
138: SANTA BRAZ	: Sao Miguel, Santa Maria Is. (Azores)	
139: SANTO (DOS)	: Espirito Santo Is.	
140: SAPPER HILL 1943	: East Falkland Is.	
141: SOUTH AMERICAN 1969MN	: Mean Value	
142: SOUTH AMERICAN 1969AG	: Argentina	
143: SOUTH AMERICAN 1969BO	: Bolivia	
144: SOUTH AMERICAN 1969BR	: Brazil	
145: SOUTH AMERICAN 1969CH	: Chile	
146: SOUTH AMERICAN 1969CO	: Columbia	
147: SOUTH AMERICAN 1969EC	: Ecuador	
148: SOUTH AMERICAN 1969GY	: Guyana	
149: SOUTH AMERICAN 1969PA	: Paraguay	
150: SOUTH AMERICAN 1969PR	: Peru	
151: SOUTH AMERICAN 1969TT	: Trinidad & Tobago	
152: SOUTH AMERICAN 1969VZ	: Venezuela	
153: SOUTH ASIA	: Singapore	
154: SOUTHEAST BASE	: Porto Santo & Madeira Is.	
155: SOUTHWEST BASE	: Faial, Graciosa, Pico, Sao Jorge & Terceira Is.	
156: TIMBALAI 1948	: Brunei & East Malaysia (Sarawak & Sabah)	
157: TOKYO JP	: Japan	
158: TOKYO KP	: Korea	
159: TOKYO OK	: Okinawa	
160: TRISTAN ASTRO 1968	: Tristan da Cunha	
161: VITI LEVU 1916	: Viti Levu Is. (Fiji Is.)	
162: WAKE-ENIWETOK 1960	: Marshall Is.	
163: ZANDERIJ	: Surinam	
164: BUKIT RIMPAH	: Bangka & Belitung Is. (Indonesia)	
165: CAMP AREA ASTRO	: Camp Mcmurdo Area, Antarctica	
166: G. SEGARA	: Kalimantan Is. (Indonesia)	
167: HERAT NORTH	: Afghanistan	
168: HU-TZU-SHAN	: Taiwan	
169: TANANARIVE OBSERVATORY 1925	: Madagascar	
170: YACARE	: Uruguay	
171: RT-90	: Sweden	
172: TOKYO	: Mean Value (Japan, Korea & Okinawa)	
173: AIN EL ABD 1970	: Bahrain Is.	
174: ARC 1960	: Mean Value (Kenya, Tanzania)	
175: ARS-A	: Kenya	

APPX. 2 GEODETIC CHART LIST

176: ARS-B	: Tanzania	221: INDIAN 1960	: Con Son Is. (Vietnam)
177: ASCENSION IS. 1958	: Ascension Is.	222: INDIAN 1975	: Thailand
178: CAPE CANAVERAL	: Mean Value (Florida & Bahama Is.)	223: INDONESIAN 1974	: Indonesia
179: EASTER IS. 1967	: Easter Is.	224: CO-ORDINATE SYSTEM 1937 OF ESTONIA	: Estonia
180: EUROPEAN 1950	: Portugal & Spain	225: EUROPEAN 1950	: Malta
181: JHONSTON IS. 1961	: Jhonston Is.	226: EUROPEAN 1950	: Tunisia
182: NAHRWAN	: Saudi Arabia	227: S-42 (PULKOVO 1942)	: Hungary
183: NAPARIMA, BWI	: Trinidad & Tobago	228: S-42 (PULKOVO 1942)	: Poland
184: NORTH AMERICAN 1927	: Caribbeen	229: S-42 (PULKOVO 1942)	: Czechoslovakia
185: OLD HAWAIIAN	: Oahu	230: S-42 (PULKOVO 1942)	: Latvia
186: SAPPER HILL 1943	: East Falkland Is.	231: S-42 (PULKOVO 1942)	: Kazakhstan
187: TIMBALAI 1948	: Brunei & East Malaysia (Sarawak & Sabah)	232: S-42 (PULKOVO 1942)	: Albania
188: TOKYO	: Japan	233: S-42 (PULKOVO 1942)	: Romenia
189: TOKYO	: South Korea	234: S-JTSK	: Czechoslovakia
190: TOKYO	: Okinawa	235: NORTH AMERICAN 1927	: East of 180W
191: WAKE-ENIWETOK 1960	: Marshall Is.	236: NORTH AMERICAN 1927	: West of 180W
192: HU-TZU-SHAN	: Taiwan	237: NORTH AMERICAN 1983	: Aleutian Is.
201: ADINDAN	: Burkina Faso	238: NORTH AMERICAN 1983	: Hawaii
202: ADINDAN	: Cameroon	239: SOUTH AMERICAN 1969	: Baltra, Galapagos Is.
203: ARC 1950	: Burundi	240: ANTIGUA IS. ASTRO 1943	: Antigua, Leeward Is.
204: AYABELLE LIGHTHOUSE	: Djibouti	241: DECEPTION IS.	: Deception Is., Antarctica
205: BISSAU	: Guinea-Bissau	242: FORT THOMAS 1955	: Nevis, St. Kitts, Leeward Is.
206: DABOLA	: Guinea	243: ISTS 061 ASTRO 1968	: South Georgia Is.
207: EUROPEAN 1950	: Tunisia	244: MONTERRAT IS. ASTRO 1958	: Montserrat, Leeward Is.
208: LEIGON	: Ghana	245: FEUNION	: Mascarene Is.
209: MINNA	: Cameroon	246: AMERICAN SAMOA 1962	: American Samoa Is.
210: M' PORALOKO	: Gebon	247: INDONESIAN 1974	: Indonesia
211: NORTH SAHARA 1959	: Algeria	248: KUSAIE ASTRO 1951	: Caroline Is., Fed. States of Micronesia
212: POINT58	: Mean Solution (Burkina Faso & Niger)	249: WAKE Is. ASTRO 1952	: Wake Atoll
213: POINTE NOIRE 1948	: Congo	250: EUROPEAN 1950	: Iraq, Israel, Jordan, Kuwait, Lebanon, Saudi Arabia, and Syria
214: SIERRA LEONE 1960	: Sierra Leone	251: HERMANNSKOGEL	: Yugoslavia (Prior to 1990) Slovenia, Croatia, Bosnia and Herzegovina, Serbia
215: VOIROL 1960	: Algeria	252: INDIAN	: Pakistan
216: AIN EL ABD 1970	: Saudi Arabia	253: PULKOVO 1942	: Russia
217: INDIAN	: Bangladesh	254: VOIROL 1874	: Tunisia/Algeria
218: INDIAN	: India & Nepal		
219: INDIAN 1954	: Thailand		
220: INDIAN 1960	: Vietnam (near 16N)		

APPX. 3 DIGITAL INTERFACE

Input Sentences

BWC, BWR, GGA, GLL, GNS, HDG, HDM, HDT, RMB, RMC, THS, TTM, VDM, VDO, VHW, VTG, ZDA

Output Sentences

RSD, TLL, TTM

FURUNO Proprietary Sentences

Input: PFEC (GPatt, DRtnm, DRtsm, hdcom, pirq)

Output: PFEC (DRtnm*, DRtsm*, hdcom*, pidat)

*: The indicated sentences are not output when a TZtouch series Multifunction Display or GP-3700 Chart Plotter is connected to the same network.

Input Sentence Description

BWC - Bearing and Distance to Waypoint - Great Circle

```
$ **BWC,hhmmss.ss,IIII.II, a, yyyyy.y, a, x.x., T, x.x., M, x.x., N, c--c, a *hh<CR><LF>
      1   2 3 4   5 6 7 8 9 10 11 12 13
```

1. UTC of observation (not used)
2. Waypoint latitude (0000.0000 to 9000.0000)
3. N/S
4. Waypoint longitude (0000.0000 to 18000.0000)
5. E/W
6. Bearing, degrees true (0.0 to 360.0)
7. Unit, T
8. Bearing, degrees (0.0 to 360.0)
9. Unit, M
10. Distance, nautical miles (0.0000 to 10000.0000)
11. Unit, N
12. Waypoint ID (not used)
13. Mode Indicator (A=Autonomous; D=Differential; E=Estimated; M=Manual input; S=Simulator)

BWR - Bearing and Distance to Waypoint - Rhumb Line

```
$ **BWR, hhmmss.ss, IIII.II, a, IIII.II, a, yyy.y, T, yyy.y, M, yyy.y, N, c--c, A, *hh<CR><LF>
      1   2 3 4 5 6 7 8 9 10 11 12 13
```

1. UTC of observation (not used)
2. Waypoint latitude (0000.0000 to 9000.0000)
3. N/S
4. Waypoint longitude (0000.0000 to 18000.0000)
5. E/W
6. Bearing, degrees true (0.0 to 360.0)
7. Unit, T
8. Bearing, degrees (0.0 to 360.0)
9. Unit, M
10. Distance, nautical miles (0.0000 to 10000.0000)
11. Unit, N
12. Waypoint ID (not used)
13. Mode Indicator (A=Autonomous; D=Differential; E=Estimated; M=Manual input; S=Simulator)

APPX. 3 DIGITAL INTERFACE

GGA - Global Positioning System (GPS) Fix Data

\$**GGA, hhmmss.ss, llll.lll, a, yyyyy.yyy, a, x, xx, x.x, x.x, M, x.x, M, x.x, xxxx, *hh<CR><LF>
1 2 3 4 5 6 7 8 9 10 11 12 13 14

1. UTC of position (not used)
2. Latitude (0000.0000 to 9000.0000)
3. N/S
4. Longitude (0000.0000 to 18000.0000)
5. E/W
6. GPS quality indicator (1 to 8)
7. Number of satellite in use (not used)
8. Horizontal dilution of precision (-327.64 to 999.99)
9. Antenna altitude above/below mean sea level (not used)
10. Unit (not used)
11. Geoidal separation (not used)
12. Unit (not used)
13. Age of differential GPS data (0 to 999)
14. Differential reference station ID (not used)

GLL - Geographic Position - Latitude/Longitude

\$**GLL, llll.lll, a, yyyyy.yyy, a, hhmmss.ss, a, x, *hh<CR><LF>
1 2 3 4 5 6 7

1. Latitude (0000.0000 to 9000.0000)
2. N/S
3. Longitude (0000.0000 to 18000.0000)
4. E/W
5. UTC of position (not used)
6. Status* (A=data valid; V=data invalid; null)
7. Mode indicator (A=Autonomous; D=Differential; E=Estimated; M=Manual input; N=Data not valid; S=Simulator)

*: When Mode is other than Autonomous or Differential, the Status may be A, V or null. When the Mode is either Autonomous or Differential, the Status may only be either A or null.

GNS - GNSS Fix Data

\$**GNS, hhmmss.ss, llll.lll, a, llll.lll, a, c--c, xx, x.x, x.x, x.x, x.x, x.x, a *hh<CR><LF>
1 2 3 4 5 6 7 8 9 10 11 12 13

1. UTC of position (not used)
2. Latitude (0000.0000 to 9000.0000)
3. N/S
4. Longitude (0000.0000 to 18000.0000)
5. E/W
6. Mode indicator
N=No fix; A=Autonomous; D=Differential; P=Precise; R=Real Time Kinematic; F=Float RTK;
E=Estimated; M=Manual input; S=Simulator
7. Total number of satellites in use (not used)
8. HDOP (1 to 999.99)
9. Antenna altitude, meters (not used)
10. Geoidal separation (not used)
11. Age of differential data (0 to 999)
12. Differential reference station ID (not used)
13. Navigational status indicator
S=Safe; C=Caution; U=Unsafe; V=Navigational status not valid

HDG - Heading, Deviation and Variation

\$**HDG, x.x, x.x, a, x.x, a *hh<CR><LF>
 1 2 3 4 5

1. Magnetic sensor heading, degrees (0.0 to 360.0)
2. Magnetic deviation, degrees (0.0 to 180.00)
3. E/W
4. Magnetic variation, degrees (0.0 to 180.00)
5. E/W

HDM - Heading, Magnetic

\$**HDM, x.x, M *hh<CR><LF>
 1 2

1. Heading, degrees (0.0 to 360.0)
2. Magnetic (M)

HDT - Heading, True

\$**HDT, xxx.x, T *hh<CR><LF>
 1 2

1. Heading, degrees (0.0 to 360.0)
2. True (T)

RMB - Recommended Minimum Specific Navigation Information

\$**RMB, A, x.x, L, CCCC, CCCC, xxxx.xx, a, xxxxxx.xx, a, xxx.x, xxx, xx.x, A, a *hh <CR><LF>
 1 2 3 4 5 6 7 8 9 10 11 12 13 14

1. Data status (A=Data valid; V=Navigation receiver warning)
2. Cross track error (NM) (not used)
3. Direction to steer (L/R) (not used)
4. Origin waypoint ID (not used)
5. Destination waypoint ID (up to 15 characters)
6. Destination waypoint latitude (0000.0000 to 9000.0000)
7. N/S
8. Destination waypoint longitude (0000.0000 to 18000.0000)
9. E/W
10. Range to destination, nautical miles (00000.0000 to 10000.0000)
11. Bearing to destination, degrees true (0.0 to 360.0)
12. Destination closing velocity, knots (not used)
13. Arrival status (not used)
14. Mode indicator (A= Autonomous; D= Differential; E=Estimated; M=Manual input; S= Simulator; N=Data not valid)

APPX. 3 DIGITAL INTERFACE

RMC - Recommended Minimum Specific GNSS Data

```
$**RMC, hhhmss.ss, A, llll.ll, a, yyyyy.yy, a, x.x, x.x, ddmmyy, x.x, a, a, a *hh<CR><LF>
      1  2  3  4  5      6 7  8  9      10 11 12 13
```

1. UTC of position fix (not used)
2. Status* (A=data valid, V=navigation receiver warning)
3. Latitude (0000.0000 to 9000.0000)
4. N/S
5. Longitude (0000.0000 to 18000.0000)
6. E/W
7. Speed over ground, knots (0.0 to 1273.9)
8. Course over ground, degrees true (0.0 to 360.0)
9. Date (not used)
10. Magnetic variation, degrees (0.00 to 180.0)
11. E/W
12. Mode indicator
A=Autonomous; D=Differential; E=Estimated; F=Float RTK; M=Manual; P=Precise;
R=Real time kinematic; S=Simulator; N=No fix
13. Navigational status indication
S=Safe; C=Caution; U=Unsafe; V=Navigational status not valid

THS-True Heading and Status

```
$**THS, xxx.x, a *hh<CR><LF>
      1  2
```

1. Heading, degrees True (0.0 to 360.0)
2. Mode indicator
A=Autonomous; E=Estimated; M=Manual input;
S=Simulator; V=Data not valid

TTM-Tracked Target Message

```
$**TTM, xx, x.x, x.x, a, x.x, x.x, a, x.x, x.x, a, c--c, a, a, hhhmss.ss, a *hh<CR><LF>
      1  2  3  4  5  6  7  8  9 10 11 12 13      14      15
```

1. Target number (00 to 100)
2. Target distance from own ship (0.000 to 99.999)
3. Bearing from own ship, degrees (0.0 to 360.0)
4. True or Relative (T, R)
5. Target speed (not used)
6. Target course, degrees (not used)
7. True or Relative (not used)
8. Distance of closet point of approach (not used)
9. Time to CPA, min., "-" increasing (not used)
10. Speed/distance units (K=km, km/h; N=nm, kn; S=sm, mph)
11. Target name (not used)
12. Target status (not used)
13. Reference target (not used)
14. UTC of data (not used)
15. Type of acquisition (not used)

VDM-AIS VHF Data-Link Message

!**VDM, x, x, x, x, s--s, x, *hh<CR><LF>
 1 2 3 4 5 6

1. Total number of sentences needed to transfer the message (1 to 9)
2. Message sentence number (1 to 9)
3. Sequential message identifier (0 to 9, null)
4. AIS channel Number (A or B)
5. Encapsulated ITU-R M.1371 radio message (1 to 62 bytes)*
6. Number of fill-bits (0 to 5)

*: This equipment only accepts ITU-R M. 1371 messages with the following IDs: 1, 2, 3, 4, 5, 6, 7, 8, 9, 11, 12, 14, 18, 19, 21, 24.

VDO

!**VDO,x,x,x,x,s--s,x,*hh<CR><LF>
 1 2 3 4 5 6

1. Total number of sentences needed to transfer the message (1 to 9)
2. Message sentence number (1 to 9)
3. Sequential message identifier (0 to 9, null)
4. AIS channel Number* (A, B, C, D, null)
5. Encapsulated ITU-R M.1371 radio message (1 to 62 bytes)
6. Number of fill-bits (0 to 5)

*: Channel numbers C and D are only used with vessels which are compliant with the relevant regulations.

VTG-Course Over Ground and Ground Speed

\$**VTG, x.x, T, x.x, M, x.x, N, x.x, K, a, *hh <CR><LF>
 1 2 3 4 5 6 7 8 9

1. Course over ground, degrees (0.0 to 360.0)
2. T=True (fixed)
3. Course over ground, degrees (not used)
4. M=Magnetic (not used)
5. Speed over ground, knots (0.00 to 1237.9)
6. N=Knots (fixed)
7. Speed over ground (0.00 to 2359.3)
8. K=km/h (fixed)
9. Mode indicator
 (A=Autonomous, D=Differential, E=Estimated (dead reckoning),
 M=Manual input, P=Precision, S=Simulator)

ZDA-Time and Date

\$**ZDA, hhmmss.ss, xx, xx, xxxx, xx, xx *hh<CR><LF>
 1 2 3 4 5 6

1. UTC (000000.00 to 235959.00)
2. Day (01 to 31)
3. Month (01 to 12)
4. Year (UTC, 0000 to 9999)
5. Local zone, hours (not used)
6. Local zone, minutes (not used)

Output Sentence Description

RSD - Radar System Data

\$**RSD,x.x,x.x,x.x,x.x,x.x,x.x,x.x,x.x,x.x,x.x,x.x,N,H*hh <CR><LF>
 1 2 3 4 5 6 7 8 9 10 11 12 13

1. Origin 1 range (0.000 to 999.9, null) (see note 2)
2. Origin 1 bearing (0.0 to 359.9, null) (see note 2)
3. Variable range marker 1 (VRM1) range (0.000 to 999.9, null)
4. Bearing line 1 (EBL1) degrees from 0 (0.0 to 359.9, null)
5. Origin 2 range (0.000 to 999.9, null) (see note 2)
6. Origin 2 bearing (0.0 to 359.9, null)(see note 2)
7. VRM2 range (0.000 to 999.9, null)
8. EBL2 degrees (0.0 to 359.9, null)
9. Cursor range, from own ship (0.000 to 999.9, null)
10. Cursor bearing (0.0 to 359.9, null)
11. Range scale in use (0.063 to 120)
12. Range units (K/N/S)
13. Display rotation (see note 1)

NOTES

- 1 Display rotation:
 C=Course-up, course-over-ground up, degrees true
 H=Head-up, ship's heading(center-line) 0 up, True motion
 N=North-up, true north is 0 up, True view
 Null=Stern-up RM
- 2 Origin 1 and origin 2 are located at the stated range and bearing from own ship for two independent sets of variable range markers (VRM) and electronic bearing originating away from own ship position.

TLL - Target Latitude and Longitude

\$**TLL, xx, llll.ll, a, yyyy.yy, a, c--c, hhmmss.ss, a, a *hh<CR><LF>
 1 2 3 4 5 6 7 8 9

1. Target number (Fixed at null)
2. Target Latitude (0000.0000 to 8459.9999)
3. Target N/S (N/S)
4. Target Longitude (00000.0000 to 18000.0000)
5. Target E/W (E/W)
6. Target name (Fixed at null)
7. UTC of data (000000.00 to 240001.99, null)
8. Target status (Fixed at null)
9. Reference target (Fixed at null)

TTM - Tracked Target Message

\$**TTM, xx, x.x, x.x, a, x.x, x.x, a, x.x, x.x, a, c--c, a, a, hhmss.ss, a *hh<CR><LF>
 1 2 3 4 5 6 7 8 9 10 11 12 13 14 15

1. Target number (00 to 100)
2. Target distance from own ship (0.0000 to 99.9994)
3. Bearing from own ship,degrees (0.00 to 360.04)
4. True or Relative (T, R)
5. Target speed*
6. Target course, degrees*
7. True or Relative*
8. Distance of closet point of approach*
9. Time to CPA, min., "-" increasing*
10. Speed/distance units (K=km, km/h; N=nm, kn; S=sm, mph)
11. Target name*
12. Target status*
13. Reference target*
14. UTC of data*
15. Type of acquisition*

Note: If a received TTM sentence is valid, the contents of the received sentence are output.

*: These fields may be blank, yet still valid, depending on the data available.

APPX. 4 RADIO REGULATORY INFORMATION

USA-Federal Communications Commission (FCC)

This device complies with part 15 of the FCC Rules. Operation is subject to the following two conditions:

- (1) This device may not cause harmful interference, and
- (2) This device must accept any interference received, including interference that may cause undesired operation. Any changes or modifications not expressly approved by the party responsible for compliance could void the user's authority to operate the equipment.

Caution: Exposure to Radio Frequency Radiation

- This equipment complies with FCC radiation exposure limits set forth for an uncontrolled environment and meets the FCC radio frequency (RF) Exposure Guidelines in Supplement C to OET65.
- This equipment should be installed and operated keeping the radiator at least 53 cm or more away from person's body.
- This device must not be co-located or operating in conjunction with any other antenna or transmitter.

Innovation, Science and Economic Development Canada (ISED)

This device contains licence-exempt transmitter(s)/receiver(s) that comply with Innovation, Science and Economic Development Canada's licence-exempt RSS(s). Operation is subject to the following two conditions:

- (1) This device may not cause interference.
- (2) This device must accept any interference, including interference that may cause undesired operation of the device.

Cet appareil contient un ou plusieurs émetteurs / récepteurs exempts de licence qui sont conformes à la norme « exempts de licence RSS (s) » Canadienne d'Innovation, Sciences et Développement économique. L'exploitation est autorisée aux deux conditions suivantes:

- (1) l'appareil ne doit pas produire de brouillage.
- (2) l'utilisateur de l'appareil doit accepter tout brouillage radioélectrique subi, même si le brouillage est susceptible d'en compromettre le fonctionnement.

Caution: Exposure to Radio Frequency Radiation

This equipment complies with ISED radiation exposure limits set forth for an uncontrolled environment and meets RSS-102 of the ISED radio frequency (RF) Exposure rules. This equipment should be installed and operated keeping the radiator at least XX cm or more away from person's body.

Cet équipement est conforme aux limites d'exposition aux rayonnements énoncées pour un environnement non contrôlé et respecte les règles d'exposition aux fréquences radioélectriques (RF) CNR-102 de l'ISED. Cet équipement doit être installé et utilisé en gardant une distance de 53 cm ou plus entre le dispositif rayonnant et le corps.

To reduce potential radio interference to other users, the antenna type and its gain should be so chosen that the equivalent isotropically radiated power (EIRP) is not more than that required for successful communication.

APPX. 5 ALERT LIST

This radar outputs alert when the alert status changes from OFF (no alert) to ON (error), an alert pop-up appears and the audio alarm sounds.

- The alert pop-up can be erased and the audio alarm silenced by pressing any key.
- The alert pop-up and the audio alarm are generated whenever an alarm condition occurs or re-occurs. This condition continues until all the causes for an alert are removed or the alert(s) are acknowledged.
- When multiple alerts are generated simultaneously, and there is no alert acknowledgement, the audio alarm continues to sound no matter even if an alert condition has gone. Also, the pop-up remains displayed and the latest alert appears in the pop-up
- When there is no alert acknowledgment, the audio alarm continues until the condition causing the alert(s) is removed. The pop-up remains displayed.
- When multiple alerts are generated simultaneously, press any key to acknowledge all alerts.
- To indicate that multiple alerts have been generated simultaneously, the pop-up shows “(!)” after the alert name, as in the example below.

[SIGNAL MISSING] [107] POSITION (!)

SIGNAL MISSING ALERTS

This radar releases an audiovisual alarm against missing signals.

- [SIGNAL MISSING] TRIGGER
The trigger signal from the antenna unit is missing.

[SIGNAL MISSING] [101] TRIGGER

- [SIGNAL MISSING] HEADING
The heading signal from the antenna unit is missing.

[SIGNAL MISSING] [102] HEADING

- [SIGNAL MISSING] BEARING
The bearing signal from the antenna unit is missing.

[SIGNAL MISSING] [103] BEARING

- [SIGNAL MISSING] VIDEO
The video signal from the antenna unit is missing.

[SIGNAL MISSING] [104] VIDEO

- [SIGNAL MISSING] ANT ERR
No communication with antenna unit for one minute.

[SIGNAL MISSING] [105] ANT ERR

APPX. 5 ALERT LIST

- [SIGNAL MISSING] HDG
Heading signal is missing.

[SIGNAL MISSING] [106] HDG

- [SIGNAL MISSING] POSITION
Position data is missing.

[SIGNAL MISSING] [107] POSITION

- [SIGNAL MISSING] COG/SOG
COG/SOG data is missing.

[SIGNAL MISSING] [108] COG/SOG

- [SIGNAL MISSING] RP COM ERROR
No communication with RP board for approx. one minute.

[SIGNAL MISSING] [109] RP COM ERROR

- [SIGNAL MISSING] HDG ON LAN
Heading signal on the LAN is missing.

[SIGNAL MISSING] [110] HDG ON LAN

TARGET ALARM 1 / TARGET ALARM 2 ALERTS

This radar releases an audiovisual alarm against a target that enters (or exits) the target alarm zone.

- IN
A target is entering the target alarm zone.

[TARGET ALARM 1/2] [201/301] IN

- OUT
A target is exiting the target alarm zone.

[TARGET ALARM 1/2] [202/302] OUT

TT/AIS ALERTS

The audiovisual alarm is given against TT in the following cases.

- PROXIMITY

A target is within the range set for the proximity alarm.

[TT/AIS ALARM] [401/501] PROXIMITY

- RISK VISUALIZER

A target is within the range set for risk visualizer.

[TT/AIS ALARM] [402/502] RISK VISUALIZER

- COLLISION

A tracked target whose CPA and TCPA are lower than those set for the CPA and TCPA alarm.

[TT/AIS ALARM] [403/503] COLLISION

- LOST

A tracked target has become lost.

[TT/AIR ALARM] [404/504] LOST

AIS ALERTS

This radar releases an audiovisual alarm against AIS targets in the following cases.

- TARGET FULL

The capacity for AIS targets has been reached.

[AIS ALARM] [505] TARGET FULL

- AIS COM ERROR

No communication with AIS.

[AIS ALARM] [506] AIS_COM_ERROR

Alert ID	Alert Type	Alert Message	Description
101	NO HEADING SIGNAL	SIGNAL MISSING	Heading signal input has stopped or was interrupted.
102	NO AZIMUTH SIGNAL	SIGNAL MISSING	Azimuth signal input has stopped or was interrupted.
103	NO TRIGGER SIGNAL	SIGNAL MISSING	Transmission trigger signal input has stopped or was interrupted.
104	NO VIDEO SIGNAL	SIGNAL MISSING	Video signal input has stopped or was interrupted.
105	RADAR COM ERROR	SIGNAL MISSING	Communication between the antenna unit and processor unit has stopped or was interrupted.
106	NO HDG SIGNAL	SIGNAL MISSING	Heading signal input has stopped or was interrupted.

APPX. 5 ALERT LIST

Alert ID	Alert Type	Alert Message	Description
107	NO POSITION SIGNAL	SIGNAL MISSING	Positioning signal input has stopped or was interrupted.
108	NO COG/SOG SIGNAL	SIGNAL MISSING	COG/SOG signal input has stopped or was interrupted.
109	RP COM ERROR	SIGNAL MISSING	(Only appears for systems which have, or had, a RP board connected at any time) Communication between the antenna unit and processor unit has stopped or was interrupted.
110	HDG ON LAN	SIGNAL MISSING	Processor unit's calculated heading is accurate, but the signal sent to the antenna is invalid.
201	TARGET ALARM 1	IN	One or more targets were detected entering the alarm zone.
301	TARGET ALARM 2	IN	
202	TARGET ALARM 1	OUT	One or more targets were detected leaving the alarm zone.
302	TARGET ALARM 2	OUT	
401	PROXIMITY	TT ALARM	When the TT target approaches within the range set by the [Proximity].
402	RISK VISUALIZER ALERT	TT ALARM	When the route is not changed, there is a risk of collision with the target within the set time.
403	TT DANGER OF COLLISION	TT ALARM	TT target is on a possible collision course with your vessel.
404	TT TARGET LOST	TT ALARM	TT has been lost and cannot be tracked.
501	PROXIMITY	AIS ALARM	When the AIS target approaches within the range set by the [Proximity].
502	RISK VISUALIZER ALERT	AIS ALARM	When the route is not changed, there is a risk of collision with the target within the set time.
503	AIS DANGER OF COLLISION	AIS ALARM	AIS target is on a possible collision course with your vessel.
504	AIS TARGET LOST	AIS ALARM	AIS has been lost and cannot be tracked.
505	AIS DISPLAY FULL	AIS ALARM	Maximum number of displayable AIS targets has been reached.
506	AIS COM ERROR	AIS ALARM	Communication with the AIS transponder is interrupted or stopped.
601	ANT FAN SPEED ERROR	OTHER	Detects FAN speed decrease (including stop) in the antenna unit.
602	INVALID MENU FILE	OTHER	Selected menu file is invalid.
603	LAN NETWORK ERROR	OTHER	Duplicate IP addresses detected.
604	HIGH TEMP	OTHER	Processor unit has abnormally high internal temperature.
605	RP HW ERROR	OTHER	An error has occurred on the RP Board and requires a system restart.
606	CHART MEMORY ERROR	OTHER	Chart was not read due to an error.

Alert ID	Alert Type	Alert Message	Description
607	DATA R/W/D ERROR	OTHER	Failed to read/write/delete the selected data in USB memory.
608	USB OVERCURRENT	OTHER	USB input current exceeds the limit.
609	USB MEMORY FULL	OTHER	Remaining capacity of USB memory is low.

**SPECIFICATIONS OF MARINE RADAR
FR-10/12**

1 GENERAL

1.1 Range scale, Ring interval (RI) and Number of rings

Range (NM)	0.0625	0.125	0.25	0.5	0.75	1	1.5	2	3	4	6	8	12
RI (NM)	0.0125	0.025	0.05	0.1	0.25	0.25	0.25	0.5	0.5	1	1	2	3
Rings	5	5	5	5	3	4	6	4	6	4	6	4	4

16	24	32	36	48	64	72	96
4	6	8	6	8	16	12	16
4	4	4	6	6	4	6	6

1.2 Screen size

FR-10 10.4-inch color LCD, portrait type, 800 x 600 (SVGA)

FR-12 12.1-inch color LCD, portrait type, 1024 x 768 (XGA)

1.3 Effective radar diameter

FR-10 158 mm nominal

FR-12 184 mm nominal

1.4 Brilliance 400 cd/m² typical

1.5 Display mode Head-up, Course-up, North-up, True motion, Stern-up

1.6 Marks Heading line, Bearing scale, Range ring, Tuning indicator, Cursor, North mark, Variable range marker (VRM),

Electric bearing line (EBL), Target alarm zone, Zoom window

1.7 Language

Burmese, Chinese, Danish, English (US/UK), French, German, Indonesian, Italian, Japanese, Korean, Malaysian, Norwegian, Russian, Spanish, Swedish, Thai, Vietnamese

1.8 Electronic chart

FR-10 Nil

FR-12 MapMedia (mm3d format)

2 INTERFACE

2.1 Number of ports

Serial 3 ports: NMEA0183 V1.5/2.0/4.0/4.1, 4800/38400 bps

Contact closure 1 port, for external buzzer or operator fitness

NMEA2000 1 port

LAN 1 port, Ethernet, 100Base-TX, RJ45

Video output 1 port, HDMI (FR-10: SVGA, FR-12: XGA)

USB 1 port, USB2.0 for USB mouse or flash memory (File system: FAT32)

2.2 Data sentences

Input BWC, BWR, GGA, GLL, GNS, HDG, HDM, HDT, RMB, RMC, THS, TTM, VDM, VDO, VHW, VTG, ZDA

Output RSD, TLL, TTM

2.3 NMEA2000 PGN

Input 059392/904, 060160/416/928, 061184, 065240, 126208/720/992/996, 127250/258, 128259, 129025/026/029/033/538, 130577/816/818/822

Output 059392/904, 060160/416/928, 061184, 126208/464/720/993/996

3 POWER SUPPLY

3.1 Display unit

FR-10 12-24 VDC: 1.1-0.6 A

FR-12 12-24 VDC: 1.7-0.9 A

3.2 Rectifier (option)

PR-62 100/110/115/220/230 VAC, 1 phase, 50/60Hz

4 ENVIRONMENTAL CONDITIONS

4.1 Ambient temperature -15°C to +55°C (storage: -30°C to +70°C)

4.2 Relative humidity 93% or less at +40°C

4.3 Degree of protection IP55 (front panel), IP22 (rear panel)

4.4 Vibration IEC 60945 Ed.4

5 UNIT COLOR

N1.0

PACKING LIST

031J-X-9852 -0 1/1

RDP-160-*

A-1

NAME	OUTLINE	DESCRIPTION/CODE No.	QTY
ユニット UNIT			
指示部 DISPLAY UNIT		RDP-160-*	1
予備品 SPARE PARTS			
予備品 SPARE PARTS		SP03-20601 001-613-100-00	1
付属品 ACCESSORIES			
付属品 ACCESSORIES		FP03-13001 001-613-160-00	1
工事材料 INSTALLATION MATERIALS			
ケーブル組品MJ CABLE ASSY.		MJ-A3SPF0024-035C 000-157-943-10	1
工事材料 INSTALLATION MATERIALS		CP03-40301 001-613-120-00	1
工事材料 INSTALLATION MATERIALS		CP03-40302 001-613-140-00	1
工事材料 INSTALLATION MATERIALS		CP03-40311 001-613-130-00	1 (*1)
図書 DOCUMENT			
フラッシュマウント型紙 TEMPLATE		C32-02104-*000-199-070-1*	1
取扱説明書 OPERATOR'S MANUAL		O**-36870-*000-199-073-1**	1

1.コード番号末尾の[*]は、選択品の代表コードを表します。
1.CODE NUMBER ENDING WITH "*" INDICATES THE CODE NUMBER OF REPRESENTATIVE MATERIAL.
2.(*1)の工事材料は、中国仕様専用
2.(*1) MARKED INSTALLATION MATERIALS ARE FOR CHINESE SET ONLY.

(略図の寸法は、参考値です。 DIMENSIONS IN DRAWING FOR REFERENCE ONLY.)

CN

C3687-Z01-A

PACKING LIST

031J-X-9853 -1 1/1

RDP-161-*

A-2

NAME	OUTLINE	DESCRIPTION/CODE No.	QTY
ユニット UNIT			
指示部 DISPLAY UNIT		RDP-161-*	1
予備品 SPARE PARTS			
予備品 SPARE PARTS		SP03-20701 001-613-110-00	1
付属品 ACCESSORIES			
付属品 ACCESSORIES		FP03-13101 001-613-170-00	1
工事材料 INSTALLATION MATERIALS			
ケーブル組品MJ CABLE ASSEMBLY		MJ-A3SPF0013A-035C 000-176-666-10	1
工事材料 INSTALLATION MATERIALS		CP03-40301 001-613-120-00	1
工事材料 INSTALLATION MATERIALS		CP03-40311 001-613-130-00	1 (*1)
工事材料 INSTALLATION MATERIALS		CP03-40402 001-613-150-00	1
図書 DOCUMENT			
フラッシュマウント型紙 TEMPLATE		C32-02108-*000-199-160-1*	1
取扱説明書 OPERATOR'S MANUAL		O**-36870-*000-199-073-1**	1

1.コード番号末尾の[*]は、選択品の代表コードを表します。
1.CODE NUMBER ENDING WITH "*" INDICATES THE CODE NUMBER OF REPRESENTATIVE MATERIAL.
2.(*1)の工事材料は、中国仕様専用
2.(*1) MARKED INSTALLATION MATERIALS ARE FOR CHINESE SET ONLY.

(略図の寸法は、参考値です。 DIMENSIONS IN DRAWING FOR REFERENCE ONLY.)

CN

C3688-Z01-B

A-3

FURUNO

CODE NO. 001-613-120-00 031J-X-9401-0
TYPE CP03-40301 1/1

番号 NO.	名称 NAME	略図 OUTLINE	型名/規格 DESCRIPTIONS	数量 QTY	用途/備考 REMARKS
工事材料表 RDP-160/161					
INSTALLATION MATERIALS					
1	バインドタップネジ BINDER TAPPING SCREW		EX20 SUS304 CODE NO. 000-163-915-10	4	
2	ケーブルタイ CABLE TIE		CV-100N CODE NO. 000-182-167-10	6	

(略図の寸法は、参考値です。 DIMENSIONS IN DRAWING FOR REFERENCE ONLY.)

FURUNO ELECTRIC CO., LTD.

CN

C3687-M01-A

A-4

FURUNO

CODE NO. 001-613-140-00 031J-X-9403-0
TYPE CP03-40302 1/1

番号 NO.	名称 NAME	略図 OUTLINE	型名/規格 DESCRIPTIONS	数量 QTY	用途/備考 REMARKS
工事材料表 RDP-160					
INSTALLATION MATERIALS					
1	Fマウントスポンジ10H F MOUNTING SPONGE 10H		03-201-1043-0 CODE NO. 100-439-180-10	2	
2	Fマウントスポンジ10V F MOUNTING SPONGE 10V		03-201-1044-0 CODE NO. 100-439-200-10	2	

(略図の寸法は、参考値です。 DIMENSIONS IN DRAWING FOR REFERENCE ONLY.)

FURUNO ELECTRIC CO., LTD.

CN

C3688-M03-A

FURUNO

CODE NO.	001-613-110-00	031J-X-9302-0 1/1
TYPE	SP03-20701	BOX NO. P

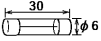
SHIP NO.	SPARE PARTS LIST FOR		U S E			SETS PER VESSEL	
	RDP-161						
ITEM NO.	NAME OF PART	OUTLINE	DWG. NO. OR TYPE NO.	QUANTITY			REMARKS/CODE NO.
				WORKING PER SET	PER VES	SPARE	
1	t ₂ -X GLASS TUBE FUSE		F800-A 250V 3A PBF	1	1	1	000-155-841-10
MFR'S NAME	FURUNO ELECTRIC CO., LTD.		DWG. NO.	C3688-P01-A	CN	1/1	

(略図の寸法は、参考値です。 DIMENSIONS IN DRAWING FOR REFERENCE ONLY.)



表 1 TABLE 1

寸法区分 (mm) 公差 (mm)	DIMENSION TOLERANCE
L ≤ 50	±1.5
50 < L ≤ 100	±2.5
100 < L ≤ 500	±3

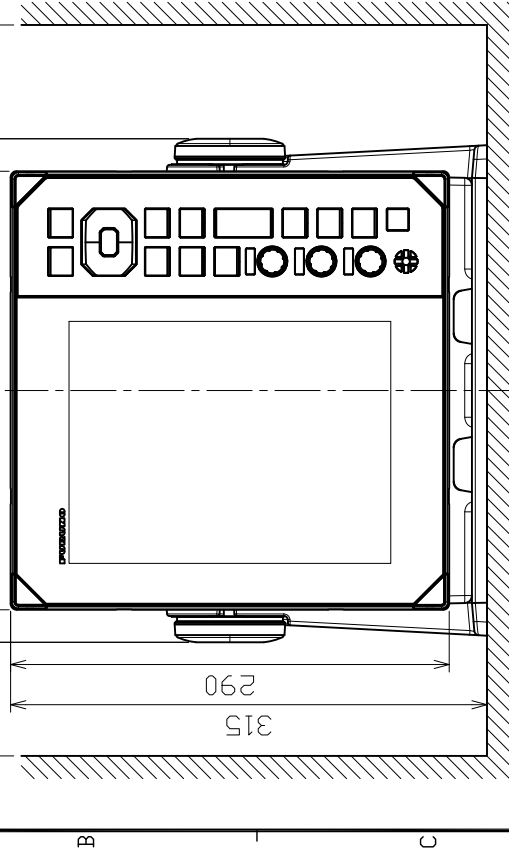
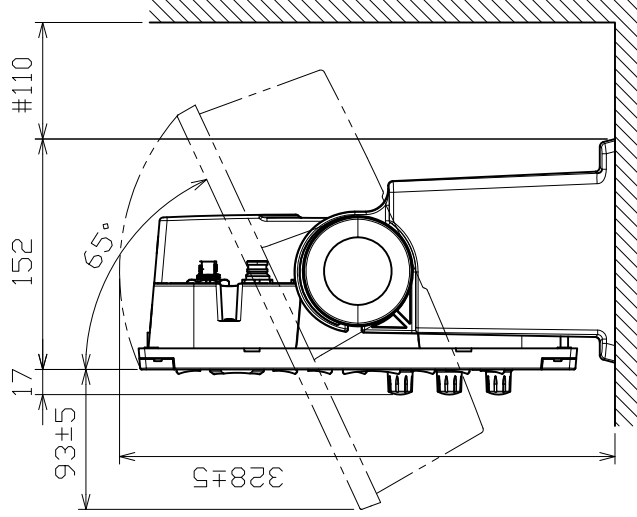
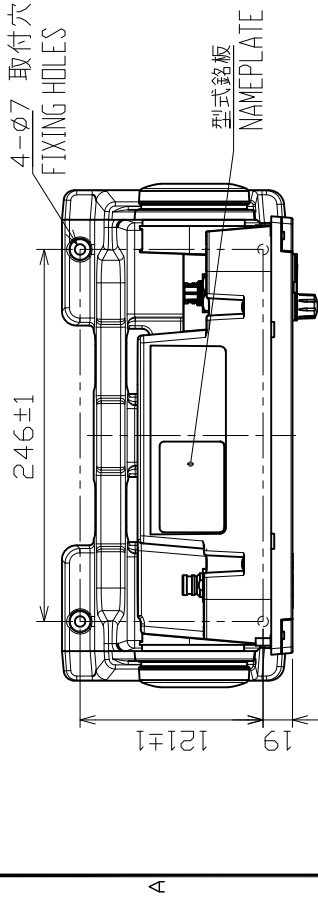
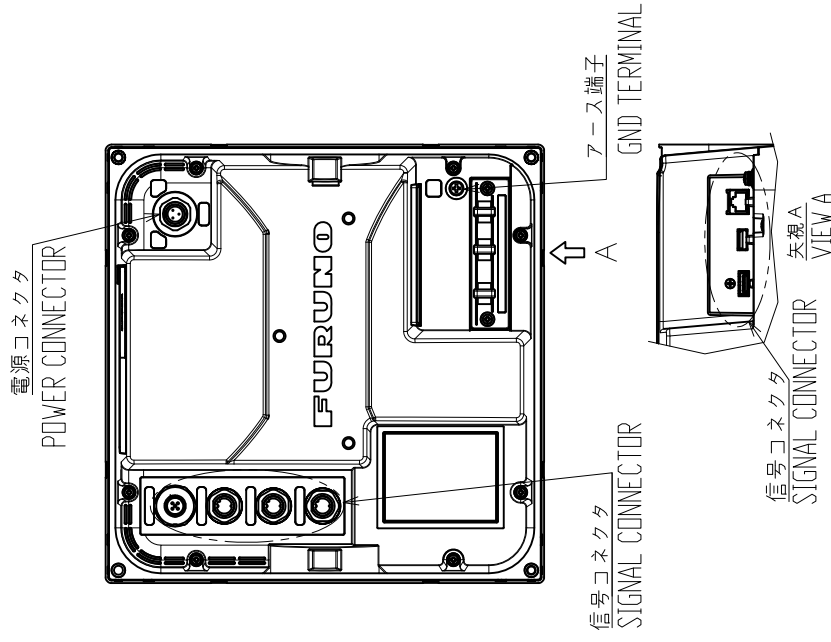

注 記

- 1) 指定外の寸法公差は表 1 による。
- 2) # 印寸法は最小サービスクリアランスとする。
- 3) 取付用ネジはバイネジ呼び径 5 × 2.0 を使用のこと。

NOTE

1. TABLE 1 INDICATES TOLERANCE OF DIMENSIONS WHICH IS NOT SPECIFIED.
2. # MINIMUM SERVICE CLEARANCE.
3. USE TAPPING SCREWS Ø5x2.0 FOR FIXING THE UNIT.

DRAWN	8/10/2002	YAMASAKI	TITLE	RDP-160
CHECKED	8/10/2002	YAMASAKI	名称	指示部 (卓上装備)
APPROVED			外寸図	
SCALE	1/5	MASS 3.2 100% kg	NAME	DISPLAY UNIT (TABLETOP MOUNT)
IMG.No.	C3687-601-B	REF.No.	03-201-100G-4	OUTLINE DRAWING

表1 TABLE 1

寸法区分 (mm) 公差 (mm)	DIMENSION TOLERANCE
L ≤ 50	±1.5
50 < L ≤ 100	±2.5
100 < L ≤ 500	±3

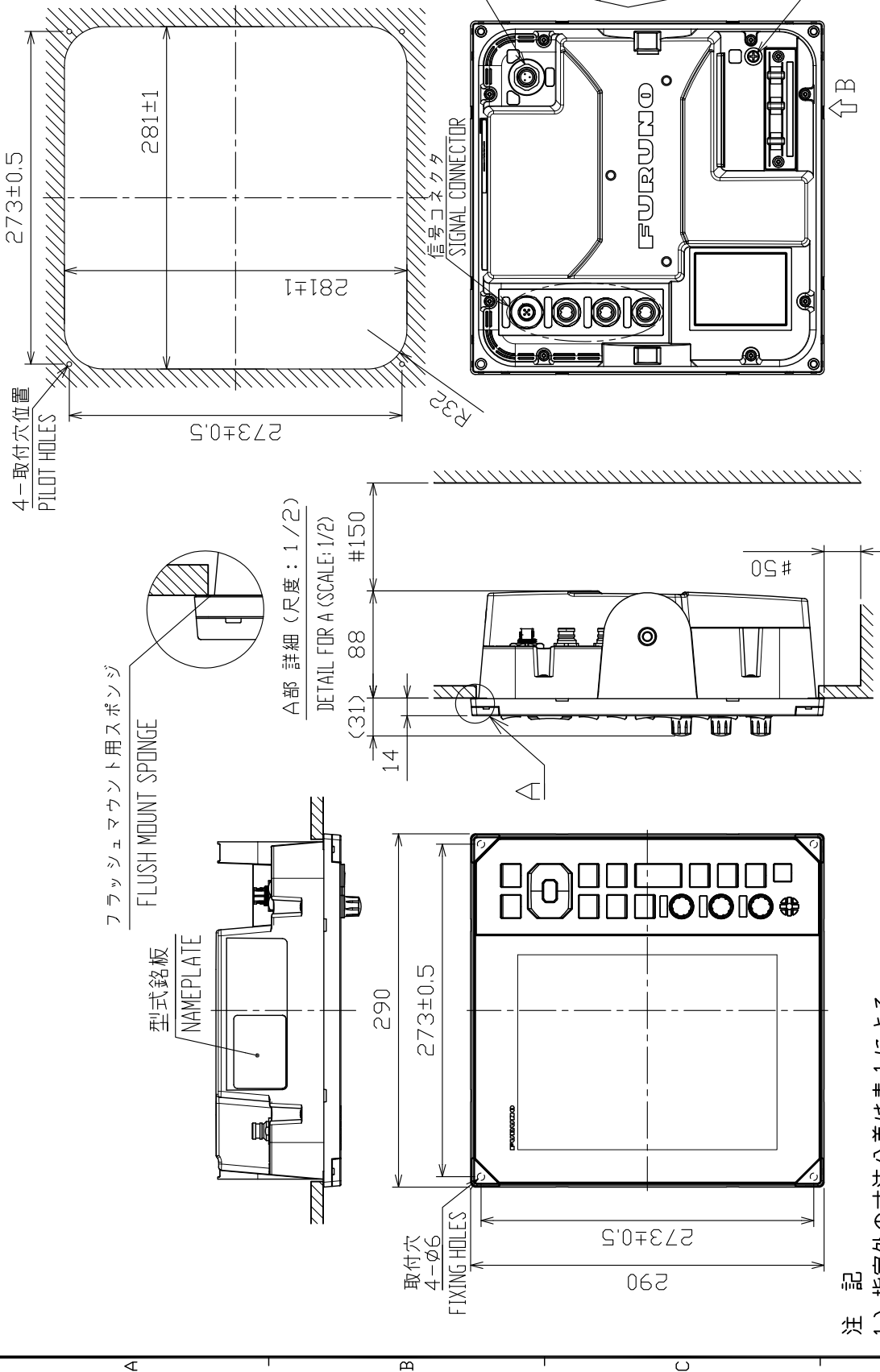

注 記

- 1) 指定外の寸法公差は表1による。
- 2) #印寸法は最小サービスクリアランスとする。
- 3) 取付用ネジはバイネジ呼び径5×20を使用のこと。

NOTE

1. TABLE 1 INDICATES TOLERANCE OF DIMENSIONS WHICH IS NOT SPECIFIED.
2. #: MINIMUM SERVICE CLEARANCE.
3. USE TAPPING SCREWS φ5x20 FOR FIXING THE UNIT.

DRAWN	25 Nov 2021	UPONDAP	TITLE	RDP-160
CHECKED	25 Nov 2021	YAMASAKI	名称	指示部 (埋込装置)
APPROVED			外寸図	
SCALE	1/5	MASS 2.5 40%	WAVE	DISPLAY UNIT (FLUSH MOUNT)
FIG. No.	C3687-602-A	REF. No.	03-201-1005-2	OUTLINE DRAWING



表1 TABLE 1

寸法区分 (mm) DIMENSION	公差 (mm) TOLERANCE
L ≤ 50	±1.5
50 < L ≤ 100	±2.5
100 < L ≤ 500	±3

表2 TABLE 2

機種 MODEL	質量 (kg±10%) MASS
標準 STANDARD	3.9
チャート (オプション) CHART (OPTION)	4.2

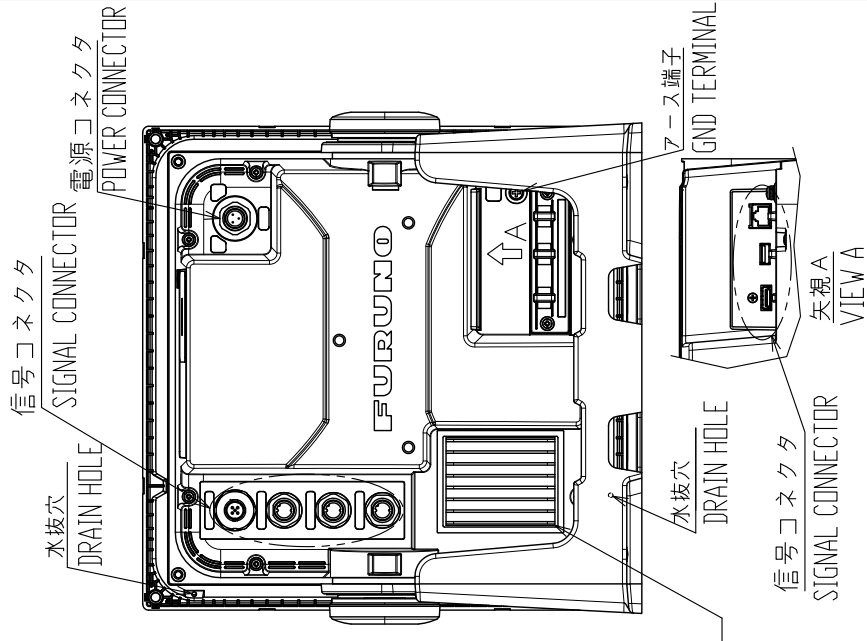
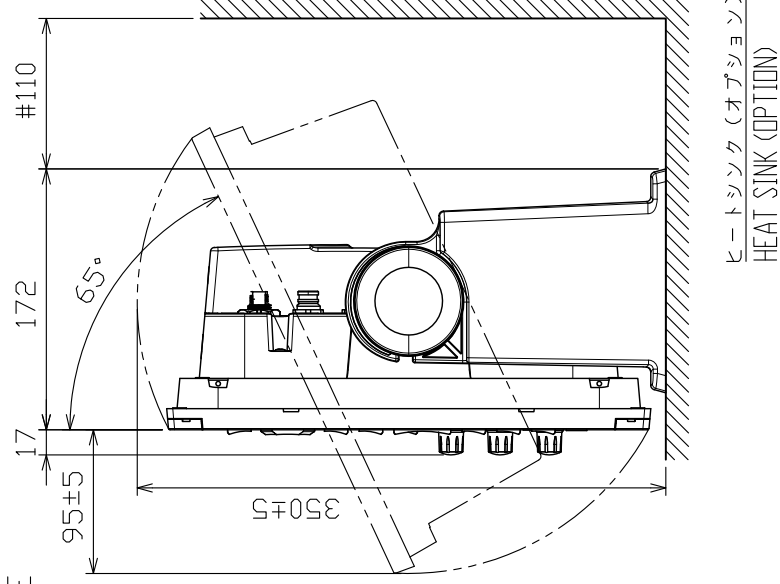
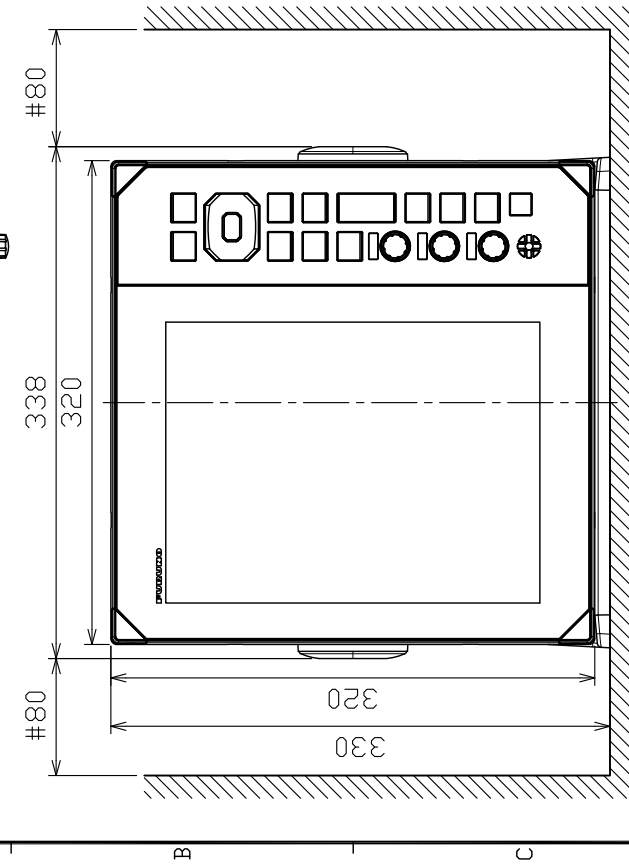
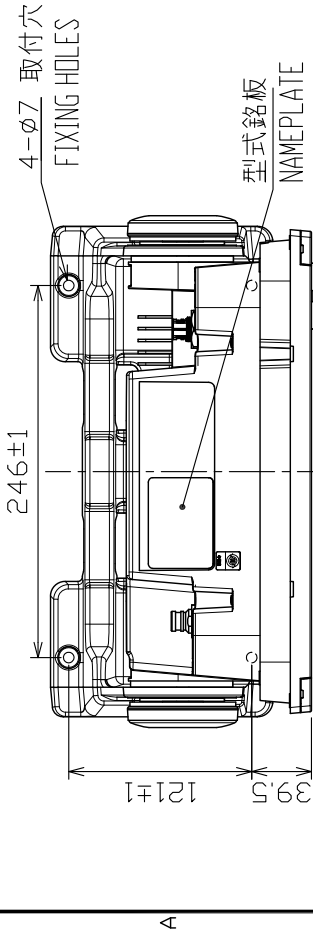
注記

- 1) 指定外の寸法公差は表1による。
- 2) #印寸法は最小サービス空間寸法とする。
- 3) 取付用ネジは+バイネジ呼び径5×20を使用のこと。

NOTE

1. TABLE 1 INDICATES TOLERANCE OF DIMENSIONS WHICH IS NOT SPECIFIED.
2. # MINIMUM SERVICE CLEARANCE.
3. USE TAPPING SCREWS φ5x20 FOR FIXING THE UNIT.

DRAWN	25/May/2021	U.PODDAR	TITLE	RDP-161
CHECKED	25/May/2021	T.YAMASAKI	名称	指示部 (卓上装備)
APPROVED	1/Feb/2022	H.MAKI	外寸図	
SCALE	1/5	質量 表2参照 TABLE 2	NAME	DISPLAY UNIT (TABLETOP MOUNT)
FIG.No.	C3688-601-A	REF.No.	03-201-1205-2	OUTLINE DRAWING

表1 TABLE 1

寸法区分 (mm) DIMENSION	公差 (mm) TOLERANCE
L ≤ 50	±1.5
50 < L ≤ 100	±2.5
100 < L ≤ 500	±3

表2 TABLE 2

機種 MODEL	質量 (kg±10%) MASS
標準 STANDARD	3.1
チャート (オプション) CHART (OPTION)	3.4

4-取付穴位置
PILOT HOLES

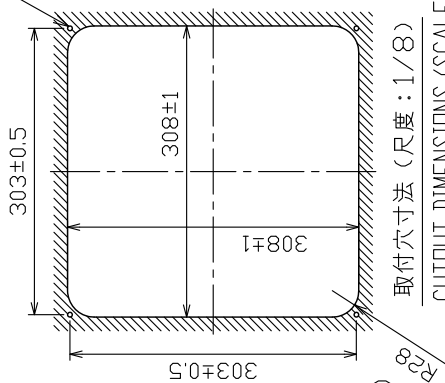

型式銘板
NAMEPLATE

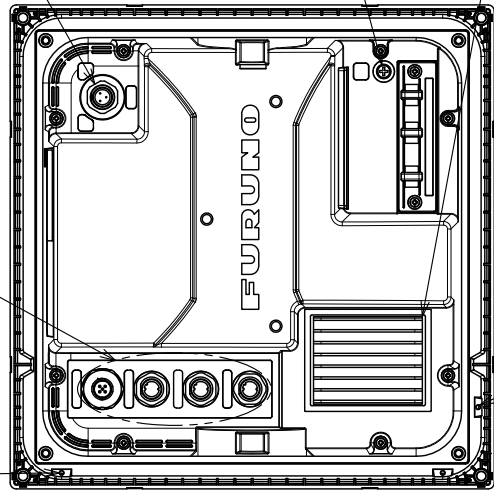
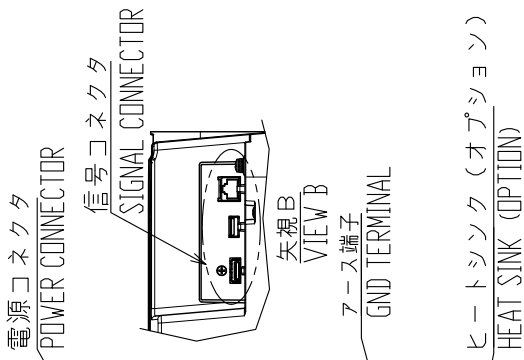
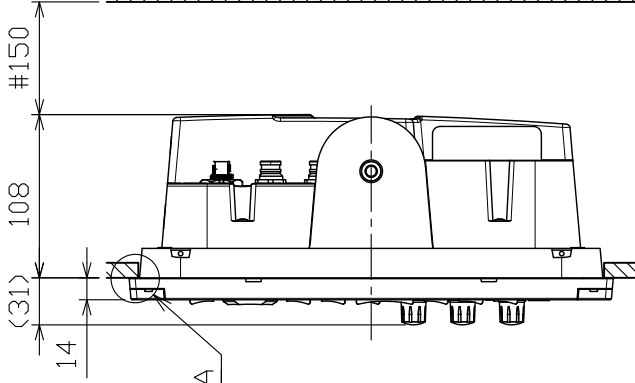
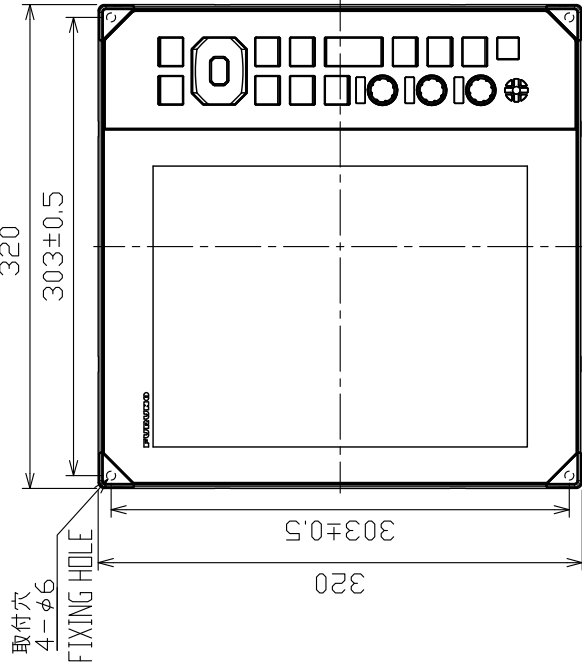
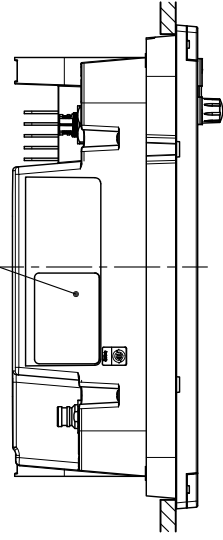

注記

- 1) 指定外の寸法公差は表1による。
- 2) #印寸法は最小サービス空間寸法とする。
- 3) 取付用ネジは+バイネジ呼び径5×20を使用のこと。

NOTE

1. TABLE 1 INDICATES TOLERANCE OF DIMENSIONS WHICH IS NOT SPECIFIED.
2. # MINIMUM SERVICE CLEARANCE.
3. USE TAPPING SCREWS Ø5x20 FOR FIXING THE UNIT.

DRAWN	25/May/2021	U.PODDAR	TITLE	RDP-161
CHECKED	25/May/2021	T.YAMASAKI	名称	指示部 (埋込装備)
APPROVED	1/Feb/2022	H.IMAKI	外寸図	
SCALE	1/5	表2参照 TABLE 2	NAME	DISPLAY UNIT (FLUSH MOUNT)
IMG.No.	C3688-002-A	REF.No.	03-201-130G-2	OUTLINE DRAWING

表1 TABLE 1

寸法区分 (mm) DIMENSION	公差 (mm) TOLERANCE
L ≤ 50	±1.5
50 < L ≤ 100	±2.5
100 < L ≤ 500	±3

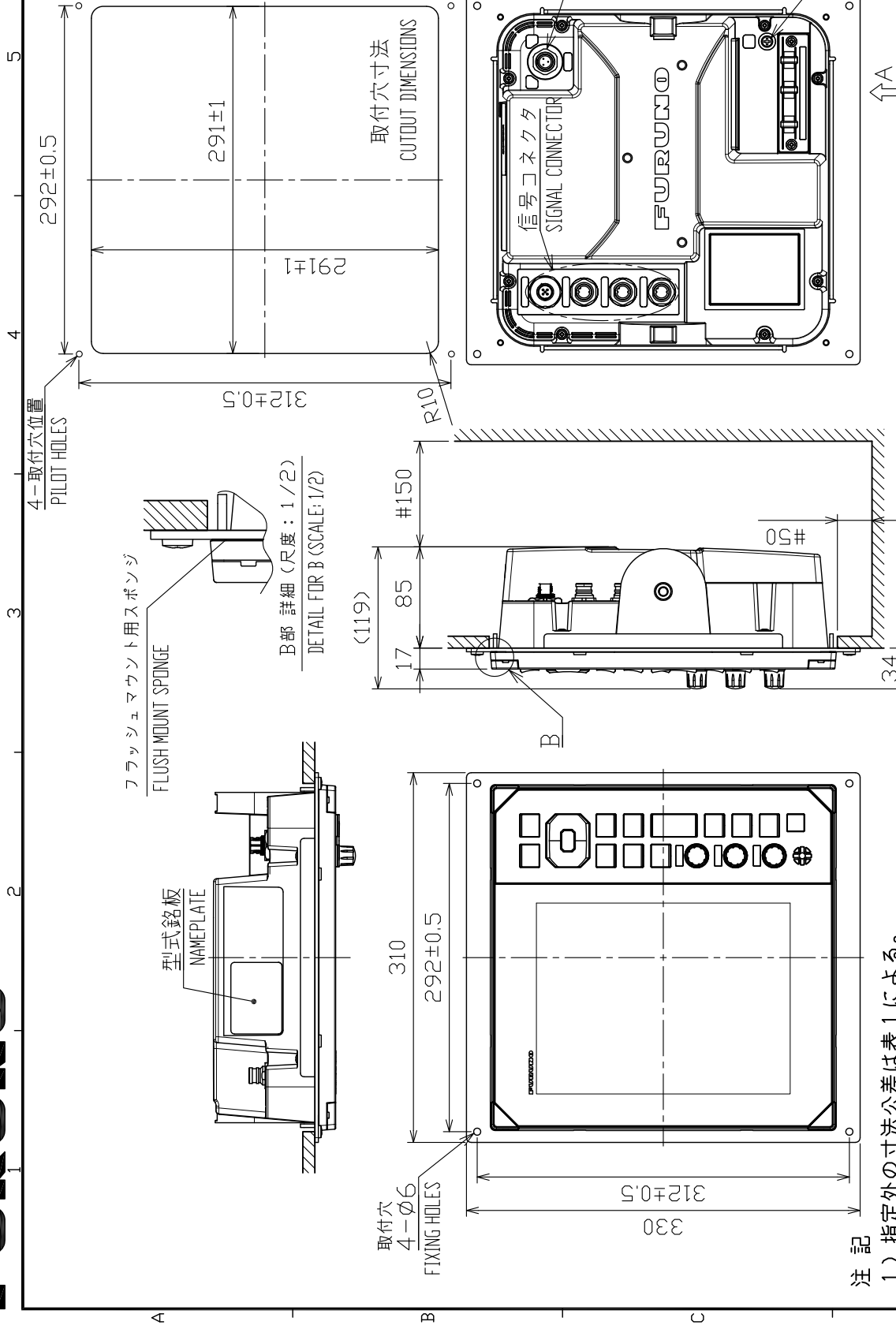

注記

- 1) 指定外の寸法公差は表1による。
- 2) #印寸法は最小サービスクリアランスとする。
- 3) 取付用ネジはバインドネジ呼び径5×20を使用のこと。
- 4) 金具取付はバインドネジM5×16を使用のこと。

NOTE

1. TABLE 1 INDICATES TOLERANCE OF DIMENSIONS WHICH IS NOT SPECIFIED.
2. # MINIMUM SERVICE CLEARANCE.
3. USE TAPPING SCREWS Ø5x20 FOR FIXING THE UNIT.
4. USE BINDING SCREWS M5x16 TO ATTACH THE FIXTURE.

DRAWN	9/June/2022 I.YAMASAKI	TITLE	RDP-160
CHECKED	9/June/2022 H.MAKI	名称	指示部 (前留パネル)
APPROVED	9/June/2022 H.MAKI	外寸図	FR-10
SCALE	1/5 MASS 2.8 100% g	NAME	DISPLAY UNIT (FRONT FIXING PANEL)
IMG.No.	C3687-603-A	REF.No.	03-201-111G-0

表1 TABLE 1

寸法区分 (mm) DIMENSION	公差 (mm) TOLERANCE
L ≤ 50	±1.5
50 < L ≤ 100	±2.5
100 < L ≤ 500	±3

表2 TABLE 2

機種仕様 TYPE	質量 (kg±10%) MASS
標準 STANDARD	3.5
オプション OPTION	3.8

4-取付穴位置
PILOT HOLES

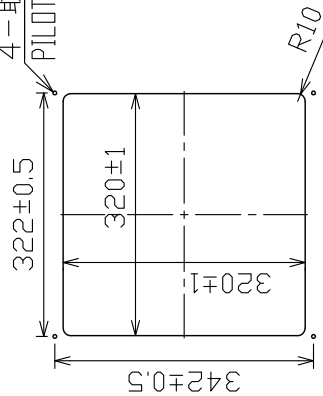

取付穴寸法 (尺度: 1/10)

CUTOUT DIMENSIONS (SCALE: 1/10)

フラッシュマウント用スポンジ
FLUSH MOUNT SPONGE

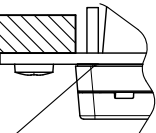

B部 詳細 (尺度: 1/2)
DETAIL FOR B (SCALE: 1/2)

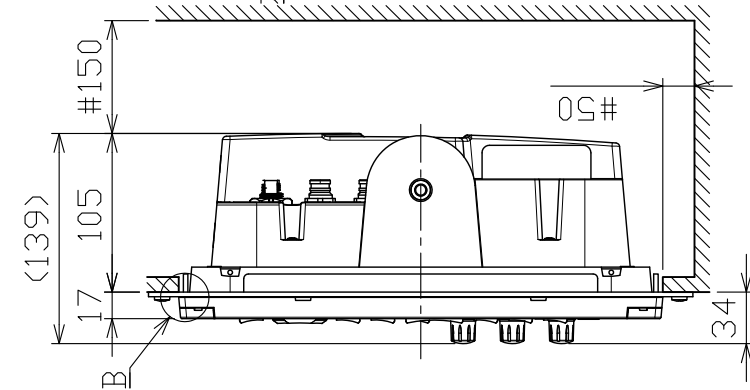

型式銘板
NAMEPLATE

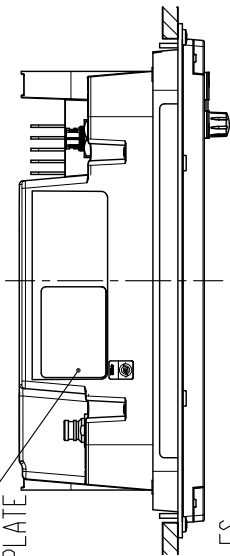

FIXING HOLES
取付穴
4-φ6

340

322±0.5

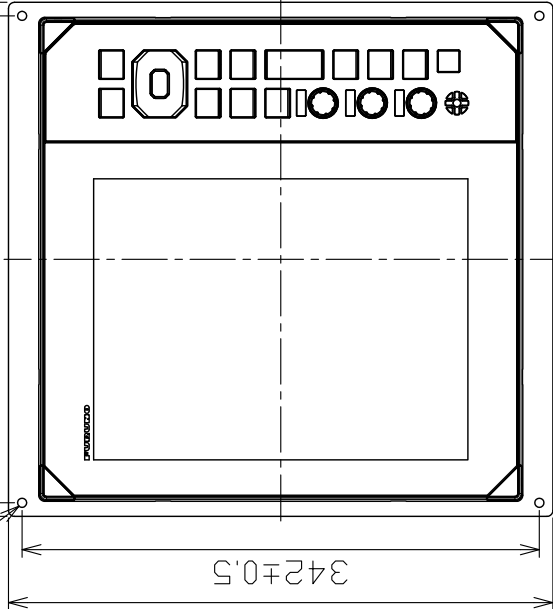

水抜穴
DRAIN HOLE

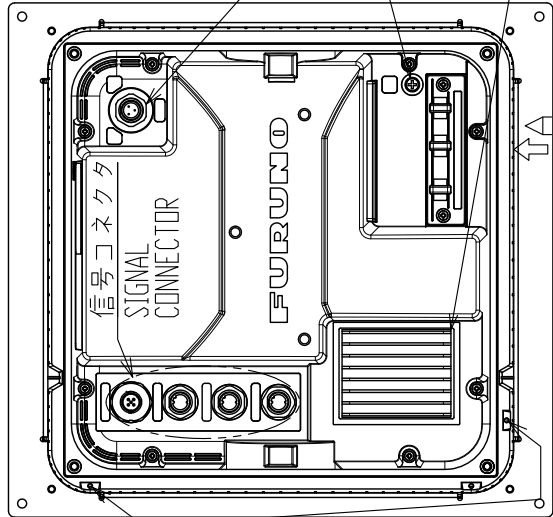

信号コネクタ
SIGNAL CONNECTOR

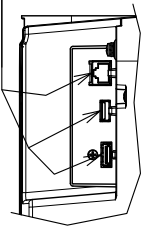

矢視A
VIEW A

電源コネクタ
POWER CONNECTOR

アース端子
GND TERMINAL

ヒートシンク (オプション)
HEAT SINK (OPTION)

注 記

- 1) 指定外の寸法公差は表1による。
- 2) #印寸法は最小サービスクリアランスとする。
- 3) 取付用ネジはバインドット呼び径5×20を使用のこと。
- 4) 金具の取付はバインド小ネジM5×16を使用のこと。

NOTE

1. TABLE 1 INDICATES TOLERANCE OF DIMENSIONS WHICH IS NOT SPECIFIED.
2. # MINIMUM SERVICE CLEARANCE.
3. USE TAPPING SCREWS Ø5x20 FOR FIXING THE UNIT.
4. USE BINDING SCREWS M5x16 TO ATTACH THE FIXTURE.

DRAWN	9/Jun/2022	I.YAMASAKI	TITLE	RDP-161
CHECKED	9/Jun/2022	H.MAKI	名称	指示部 (前留パネル)
APPROVED	9/Jun/2022	H.MAKI	図番	FR-12
SCALE	1/5	質量 TABLE 2	仕様	DISPLAY UNIT (FRONT FIXING PANEL)
FIG.No.	C3688-603-A	REF.No.	03-201-131G-0	OUTLINE DRAWING

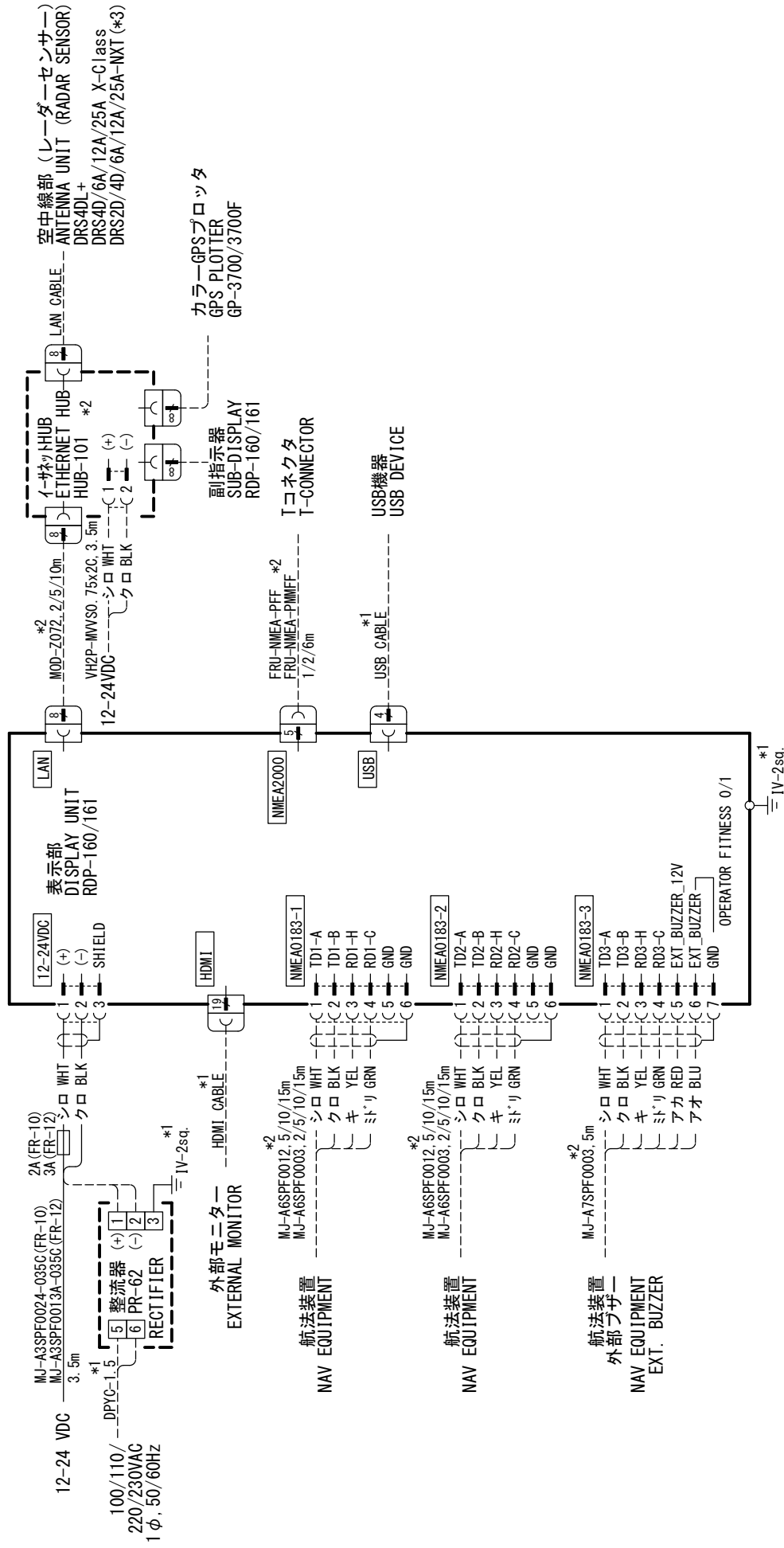

空中線部 (レーダーセンサー)
ANTENNA UNIT (RADAR SENSOR)
DRS4DL +
DRS4D/6A/12A/25A X-Class
DRS2D/4D/6A/12A/25A-NXT (*3)

カラーGPSプロッタ
GPS PLOTTER
GP-3700/3700F

副指示器
SUB-DISPLAY
RDP-160/161

Tコネクタ
T-CONNECTOR

USB機器
USB DEVICE

表示部
DISPLAY UNIT
RDP-160/161

HDMI

NMEA0183-1
TD1-A
TD1-B
RD1-H
RD1-C
GND
GND

NMEA0183-2
TD2-A
TD2-B
RD2-H
RD2-C
GND
GND

NMEA0183-3
TD3-A
TD3-B
RD3-H
RD3-C
EXT_BUZZER_12V
EXT_BUZZER
GND
GND

外部モニター
EXTERNAL MONITOR
*1
HDMI_CABLE

航法装置
NAV EQUIPMENT
*2
MJ-A6SPF0012.5/10/15m
MJ-A6SPF0003.2/5/10/15m

航法装置
NAV EQUIPMENT
*2
MJ-A6SPF0012.5/10/15m
MJ-A6SPF0003.2/5/10/15m

航法装置
外部ブザー
NAV EQUIPMENT
EXT. BUZZER
*2
MJ-A7SPF0003.5m

注記
*1) 造船所手配。
*2) オプション。
*3) DRS2D/4D-NXTは海外のみ。

NOTE
*1: SHIPYARD SUPPLY.
*2: OPTION.
*3: DRS2D/4D-NXT ARE NOT AVAILABLE IN JAPAN.

DRAWN	24/May/2022 T. YAMASAKI	TITLE	FR-10/12
CHECKED	24/May/2022 H. MAKI	名称	船舶用レーダー
APPROVED	25/May/2022 H. MAKI		相互結線図
SCALE	1/MASS kg	NAME	MARINE RADAR
DWG. No.	C3687-C01-C	REF. No.	03-201-6011-0
			INTERCONNECTION DIAGRAM

INDEX

A

AIS

- activating targets5-3
 - controls for5-1
 - CPA/TCPA alarm5-7
 - display on/off5-1
 - display range5-5
 - display sector5-5
 - lost target5-8
 - number of targets5-6
 - past position display5-7
 - proximity alarm5-8
 - sleeping targets5-3
 - sorting targets5-4
 - symbol color5-9
 - symbols4-2, 5-2
 - target data5-4
 - vector5-6
 - vector reference5-6
 - vector time5-6
- ALARM key2-35
- Alert listAP-17
- Alert status2-39
- Auto adjust clutter2-13

B

- Background color2-41
- Barge mark2-51
- Brill/Color menu2-41

C

- Character color2-41
- CHART PLOTTER
- Chart Align7-5
 - Chart Menu7-1
 - Chart Setting7-3
 - Chart Type7-2
 - Depth Line7-4
 - Depth Line Range7-5
 - Display Ext Marks7-7
 - Display Scroll7-7
 - Emphasizing Land Mass7-2
 - L/L Grid7-6
- Color
- background2-40
 - characters2-40
 - preset2-40
- Controls2-1
- Course up mode2-7
- CPA/TCPA alarm
- AIS5-7
 - TT4-11
- Cursor2-18
- CUSTOM key2-26, 2-33
- Custom setup2-33

- description of items2-33
- how to setup2-34

D

- DATA BOX knob2-49
- Digital interfaceAP-9
- Display brilliance2-4
- Display menu2-47
- Display-curve2-30
- Dynamic range2-29

E

- EBL
- measuring bearing by2-21
 - reference2-22
- Echo area2-47
- Echo average2-28
- Echo color2-40
- Echo stretch2-27

F

- False echoes3-3
- Function keys2-52
- changing function key program2-52
 - F1 key2-52
 - F2 key2-52
 - F3 key2-52
- Fuse replacement8-2

G

- Gain adjustment2-9
- Geodetic chart listAP-7

H

- Head up mode2-7
- Heading line erasure2-8

I

- Indications2-3
- Initial sub menu2-53
- Interference rejector2-29

L

- LCD test8-5, 8-6
- Lost target

 - AIS5-8

M

- Maintenance
- fuse replacement8-2
 - preventive8-1
- Menu overview2-4
- Menu treeAP-1
- Multiple echoes3-3

N

- North up mode2-7

O

- Off-center

- custom..... 2-44
- manual 2-43
- mode 2-43
- Origin mark..... 2-49
- Own ship mark 2-50
- P**
- Panel brilliance..... 2-4
- Past position display
 - AIS 5-7
 - TT 4-9
- POWER/BRILL key 2-2, 2-4
- Proximity alarm
 - AIS 5-8
 - TT 4-12
- Pulselength selection 2-26
- R**
- RACON 3-6
- Radar sensor test..... 8-7
- Radio
 - Display On/Off 6-1
 - Other ship's mark 6-1
 - Past Position Display 6-2
 - Past Position Interval 6-2
 - Symbol color 6-1
 - Target Marks Erase..... 6-3
- Radio regulator information AP-16
- Rain clutter adjustment 2-11
- Range and bearing between two targets 2-23
- RANGE knob..... 2-9
- Range measurement
 - fixed range rings..... 2-19
 - VRM 2-20
- Range ring brilliance 2-20
- S**
- SART..... 3-5
- Sea clutter adjustment 2-10
- Sector blank 2-55
- Shadow sector 3-5
- Sidelobe echoes..... 3-4
- Specifications SP-1
- System configuration..... xi
- T**
- Target alarm
 - alarm type 2-36
 - audio alarm silencing 2-36
 - deactivating 2-37
 - setting..... 2-35
 - sleeping..... 2-37
 - strength level..... 2-37
- Target analyzer 2-31
- Target trails
 - color 2-16
 - erase all trails 2-17
 - gradation 2-15
 - level..... 2-16
 - mode 2-14
 - own ship trail 2-17
- restarting 2-16
- time 2-14
- Tests
 - LCD 8-5
 - radar sensor 8-7
 - RP Unit..... 8-6
 - system 8-4
- TLL 2-49
- Troubleshooting
 - advanced-level 8-3
 - simple 8-2
- True motion mode 2-8
- TT
 - acquiring targets automatically..... 4-5
 - acquiring targets manually 4-4
 - controls for 4-1
 - CPA/TCPA alarm 4-11
 - display on/off 4-2
 - lost target 4-6
 - own ship vector 4-8
 - past position display 4-9
 - precautions..... 4-1
 - proximity alarm..... 4-12
 - stopping tracking 4-6
 - symbol color 4-3
 - target data 4-10
 - vector description 4-7
 - vector reference 4-7
- Tuning 2-25
- V**
- Vector
 - description, AIS 5-6
 - description, TT..... 4-7
 - own ship 4-8
 - reference, AIS 5-6
 - reference, TT..... 4-7, 4-8
 - time link 4-8
- Virtual image 3-4
- VRM
 - measuring range by..... 2-20
 - unit for 2-21
- W**
- Watchman 2-38
- Waypoint marker 2-50
- Z**
- Zoom
 - non-tracked target 2-45
 - reference 2-45
 - TT or AIS target..... 2-46

Declaration of Conformity

[FR-10/FR-12]

- Bulgarian (BG)** С настоящото Furuno Electric Co., Ltd. декларира, че гореспоменат тип радиосъоръжение е в съответствие с Директива 2014/53/ЕС.
Цялостният текст на ЕС декларацията за съответствие може да се намери на следния интернет адрес:
- Spanish (ES)** Por la presente, Furuno Electric Co., Ltd. declara que el tipo de equipo radioeléctrico arriba mencionado es conforme con la Directiva 2014/53/UE.
El texto completo de la declaración UE de conformidad está disponible en la dirección Internet siguiente:
- Czech (CS)** Tímto Furuno Electric Co., Ltd. prohlašuje, že výše zmíněné typ rádiového zařízení je v souladu se směrnicí 2014/53/EU.
Úplné znění EU prohlášení o shodě je k dispozici na této internetové adrese:
- Danish (DA)** Hermed erklærer Furuno Electric Co., Ltd., at ovennævnte radioudstyr er i overensstemmelse med direktiv 2014/53/EU.
EU-overensstemmelseserklæringens fulde tekst kan findes på følgende internetadresse:
- German (DE)** Hiermit erklärt die Furuno Electric Co., Ltd., dass der oben genannte Funkanlagentyp der Richtlinie 2014/53/EU entspricht.
Der vollständige Text der EU-Konformitätserklärung ist unter der folgenden Internetadresse verfügbar:
- Estonian (ET)** Käesolevaga deklareerib Furuno Electric Co., Ltd., et ülalmainitud raadioseadme tüüp vastab direktiivi 2014/53/EL nõuetele.
ELi vastavusdeklaratsiooni täielik tekst on kättesaadav järgmisel internetiaadressil:
- Greek (EL)** Με την παρούσα η Furuno Electric Co., Ltd., δηλώνει ότι ο προαναφερθέντας ραδιοεξοπλισμός πληροί την οδηγία 2014/53/ΕΕ.
Το πλήρες κείμενο της δήλωσης συμμόρφωσης ΕΕ διατίθεται στην ακόλουθη ιστοσελίδα στο διαδίκτυο:
- English (EN)** Hereby, Furuno Electric Co., Ltd. declares that the above-mentioned radio equipment type is in compliance with Directive 2014/53/EU.
The full text of the EU declaration of conformity is available at the following internet address:
- French (FR)** Le soussigné, Furuno Electric Co., Ltd., déclare que l'équipement radioélectrique du type mentionné ci-dessus est conforme à la directive 2014/53/UE.
Le texte complet de la déclaration UE de conformité est disponible à l'adresse internet suivante:
- Croatian (HR)** Furuno Electric Co., Ltd. ovime izjavljuje da je gore rečeno radijska oprema tipa u skladu s Direktivom 2014/53/EU.
Cjeloviti tekst EU izjave o sukladnosti dostupan je na sljedećoj internetskoj adresi:
- Italian (IT)** Il fabbricante, Furuno Electric Co., Ltd., dichiara che il tipo di apparecchiatura radio menzionato sopra è conforme alla direttiva 2014/53/UE.
Il testo completo della dichiarazione di conformità UE è disponibile al seguente indirizzo Internet:
- Latvian (LV)** Ar šo Furuno Electric Co., Ltd. deklarē, ka augstāk minēts radioiekārta atbilst Direktīvai 2014/53/ES.
Pilns ES atbilstības deklarācijas teksts ir pieejams šādā interneta vietnē:

- Lithuanian (LT) Aš, Furuno Electric Co., Ltd., patvirtinu, kad pirmiau minėta radijo įrenginių tipas atitinka Direktyvą 2014/53/ES.
Visas ES atitikties deklaracijos tekstas prieinamas šiuo interneto adresu:
- Hungarian (HU) Furuno Electric Co., Ltd. igazolja, hogy fent említett típusú rádióberendezés megfelel a 2014/53/EU irányelvnek.
Az EU-megfelelőségi nyilatkozat teljes szövege elérhető a következő internetes címen:
- Maltese (MT) B'dan, Furuno Electric Co., Ltd., niddikjara li msemmija hawn fuq-tip ta' taghmir tar-radju huwa konformi mad-Direttiva 2014/53/UE.
It-test kollu tad-dikjarazzjoni ta' konformità tal-UE huwa disponibbli f'dan l-indirizz tal-Internet li ġej:
- Dutch (NL) Hierbij verklaar ik, Furuno Electric Co., Ltd., dat het hierboven genoemde type radioapparaat conform is met Richtlijn 2014/53/EU.
De volledige tekst van de EU-conformiteitsverklaring kan worden geraadpleegd op het volgende internetadres:
- Polish (PL) Furuno Electric Co., Ltd. niniejszym oświadcza, że wyżej wymieniony typ urządzenia radiowego jest zgodny z dyrektywą 2014/53/UE.
Pełny tekst deklaracji zgodności UE jest dostępny pod następującym adresem internetowym:
- Portuguese (PT) O(a) abaixo assinado(a) Furuno Electric Co., Ltd. declara que o mencionado acima tipo de equipamento de rádio está em conformidade com a Diretiva 2014/53/UE.
O texto integral da declaração de conformidade está disponível no seguinte endereço de Internet:
- Romanian (RO) Prin prezenta, Furuno Electric Co., Ltd. declară că menționat mai sus tipul de echipamente radio este în conformitate cu Directiva 2014/53/UE.
Textul integral al declarației UE de conformitate este disponibil la următoarea adresă internet:
- Slovak (SK) Furuno Electric Co., Ltd. týmto vyhlasuje, že vyššie spomínané rádiové zariadenie typu je v súlade so smernicou 2014/53/EÚ.
Úplné EÚ vyhlásenie o zhode je k dispozícii na tejto internetovej adrese:
- Slovenian (SL) Furuno Electric Co., Ltd. potrjuje, da je zgoraj omenjeno tip radijske opreme skladen z Direktivo 2014/53/EU.
Celotno besedilo izjave EU o skladnosti je na voljo na naslednjem spletnem naslovu:
- Finnish (FI) Furuno Electric Co., Ltd. vakuuttaa, että yllä mainittu radiolaitetyyppi on direktiivin 2014/53/EU mukainen.
EU-vaatimustenmukaisuusvakuutuksen täysimittainen teksti on saatavilla seuraavassa internetosoitteessa:
- Swedish (SV) Härmed försäkrar Furuno Electric Co., Ltd. att ovan nämnda typ av radioutrustning överensstämmer med direktiv 2014/53/EU.
Den fullständiga texten till EU-försäkran om överensstämmelse finns på följande webbadress:

Online Resource

http://www.furuno.com/en/support/red_doc

Notice for radiated immunity

The test for the radiated immunity is performed up to 2.7 GHz only without the special condition of spot frequency being applied. There is a chance that this equipment may interfere with allocated services in the frequency range of 2.7 GHz to 6 GHz, particularly in harbors, rivers, lake banks, etc.